

FURUNO

10.4 Multi-Color LCD RADAR MODEL 1835/1935/1945



www.furuno.com

Bringing a New Level of Quality, Operability, and Reliability into Marine Radar.

Furuno's new Radar series, 1835/1935/1945, is a high contrast 10.4" color LCD radar designed for a wide range of vessels including pleasure craft, fishing boats and work boats.

These new Radars offer crystal clear target presentation with automatic Gain, Sea and Rain controls to deliver a noise-free Radar presentation. It features superb detection of even small targets both at short and long ranges. It also incorporates new display modes (ex. True View Mode, Full Screen Mode) which will assist with safe navigation. The 1835/1935/1945 series allows you to see far away objects before they are visible and allows you to see in the dark, fog or during periods of obstructed visibility in any weather condition.

These Radars can be inter-connected with other navigation equipment, chart plotters and sounders, through Furuno's programmable NMEA 0183 interface, which affords operators the ability to expand their boat's system as needed.

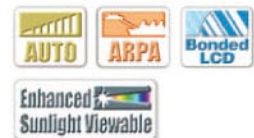

- ▶ **Easy-to-install 10.4" portrait color LCD (350 cd) display**
- ▶ **Bonded LCD provides clear view in all weather conditions**
- ▶ **Stable AIS/ARPA target-tracking with zoom display function**
- ▶ **Full Screen Mode lets operators observe a wider range around the vessel**
- ▶ **Enhanced auto tuning/gain/anti-clutter controls**
- ▶ **Echoes in yellow, green, orange or multiple colors**

AIS / ARPA Display*

Up to 100 AIS and 10 ARPA targets can be tracked and overlaid on the Radar screen to assist the operator in tracking vessel movements. Since AIS works by a VHF transceiver system, a variety of navigational information such as vessel name, speed, ROT, draft, and the destination of the selected targets can be included in real time. Unlike ARPA targets, AIS targets are visible even if they are located behind large ships or islands.

*Optional supply required



AIS targets can show that a vessel is coming from behind an island, where a Radar beam does not reach.

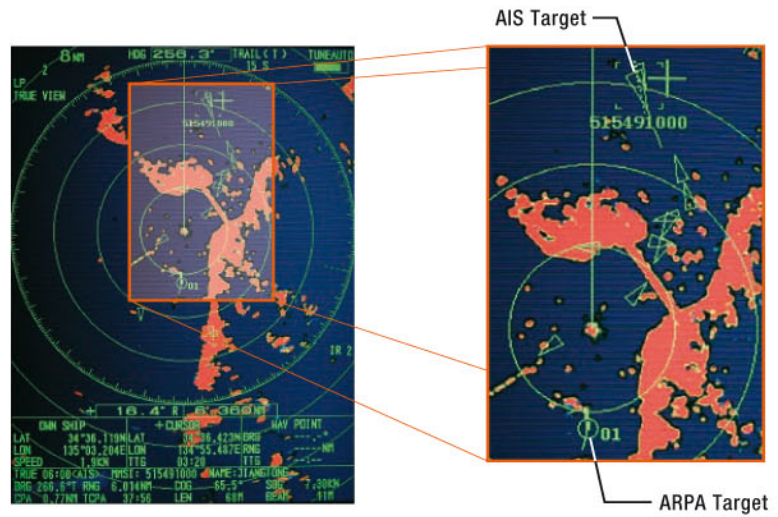

Target Zoom

A target can be shown in a zoom display while its detailed movements are tracked by AIS or ARPA. The conventional zoom function is also available by which the operator sets the zoom function on the target manually.



Target acquired and tracked.



Target shifts its position.



Zoom box tracks the target object according to its movement.

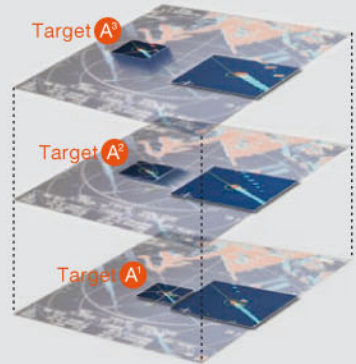

Full Screen Mode

With Full Screen Mode, the entire screen is filled with an echo image. Full-screen echo presentation capability allows the operator to observe a wider overview of the surrounding area.

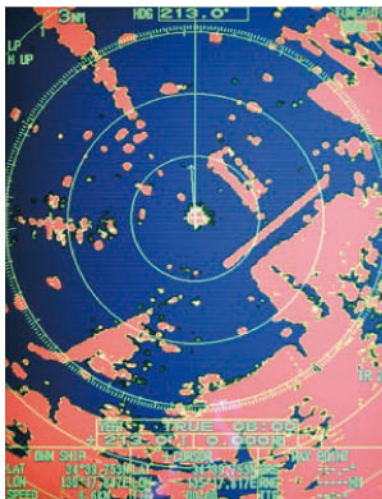

Full screen mode

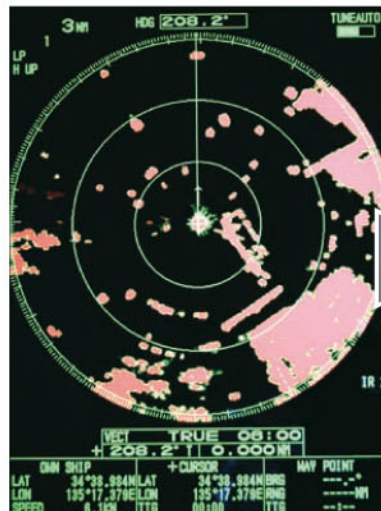

Normal mode

Data off

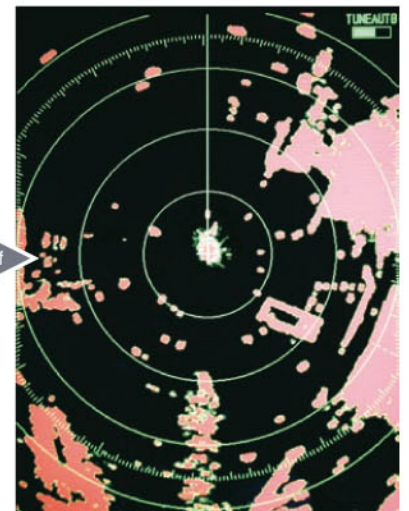

Full Screen Mode with no NAV data

There is also an option to clear the navigation data on the Radar display. Individual navigation data can be easily toggled ON or OFF in the dedicated menu.

Anti-Clutter Controls

Adding to the enhanced auto clutter controls, dedicated rotary knobs are provided for the suppression of unwanted echoes from sea clutter, rain and other forms of precipitation. Anti-clutter settings can be adjusted manually to remove sea and rain clutter from the Radar screen to gain a clearer view of Radar targets.

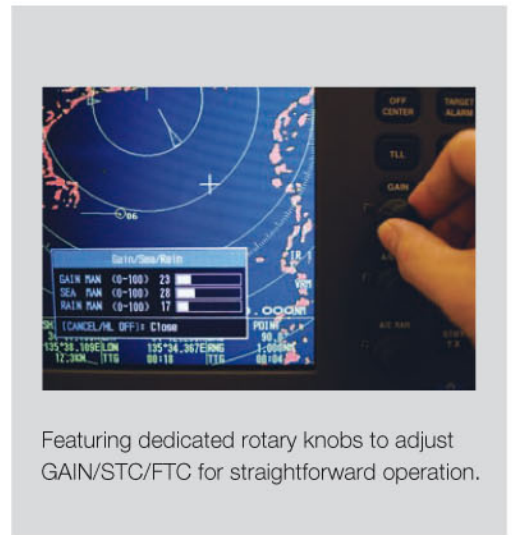
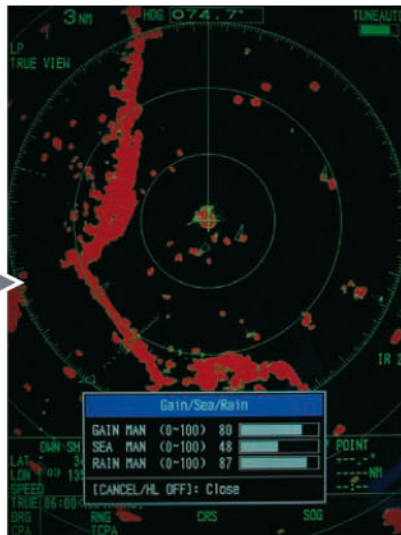
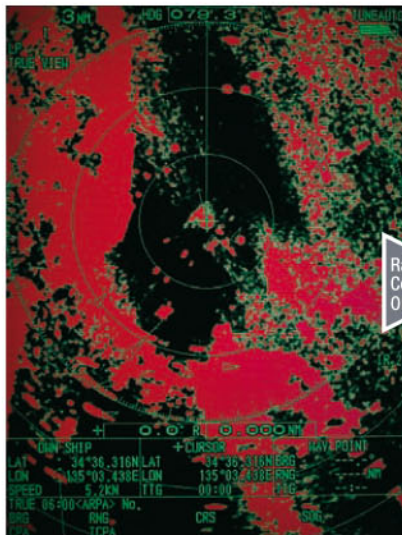

Featuring dedicated rotary knobs to adjust GAIN/STC/FTC for straightforward operation.

Rain disturbs target recognition on the Radar screen.

Short Range Target Discrimination

With its advanced signal processing technology, the 1835/1935/1945 series demonstrates substantial increases in target detection, particularly in close range. As shown in the pictures on the right, the Radar clearly displays thin piers from a very short distance.



Thin piers standing in front of a beach.

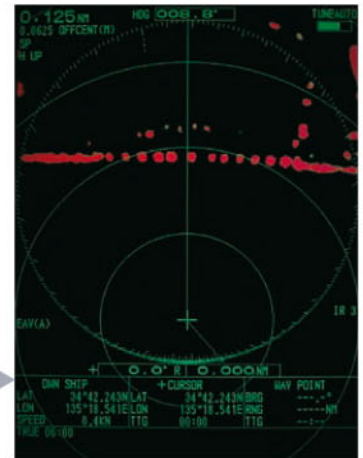

Off Center Mode

With a push of the "OFF CENTER" button, own ship position is shifted to a pre-registered point on the screen. This allows the operator to focus on a specific area ahead of or around the vessel without losing track of the position.



Off center mode

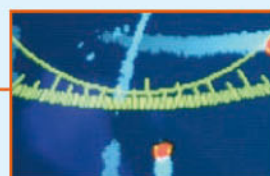

Clearance between markings of the bearing scale is changed according to the proximity between own ship and the bearing circle, as shown in the images on the left-hand side. It helps to grasp the bearing to the target echo without using EBL.

MODEL 1835 and FCV-295 Helm Solution

The cosmetic design of the 1835/1935/1945 Radar series matches with that of the FCV-295 digital echo sounder with 10.4" bonded LCD. Installed side-by-side, they will enhance the look of your helm.



COLOR LCD SOUNDER
FCV-295



10.4 Multi-Color LCD RADAR
MODEL 1835/1935/1945

Display Unit

RDP-152

5.4 kg 11.9 lb

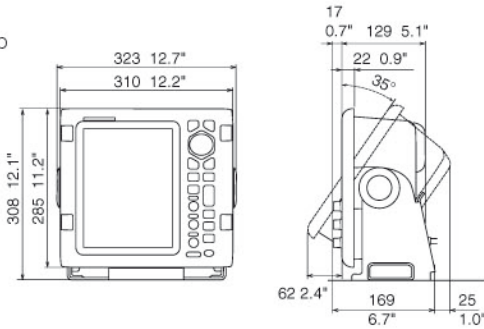

Antenna Unit

RSB-0071

8 kg 17.6 lb

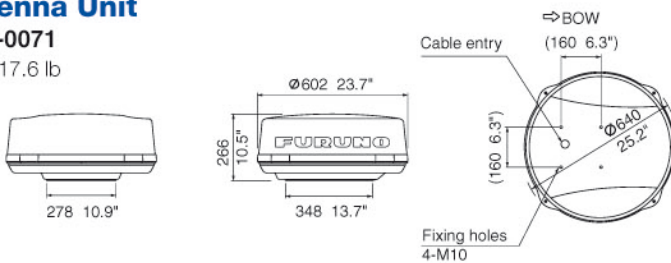

Antenna Unit

XN10A : 22 kg 48.5 lb

XN12A : 25 kg 55.1 lb

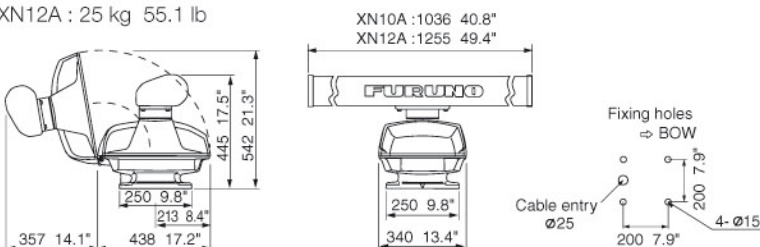

INTERCONNECTION DIAGRAM

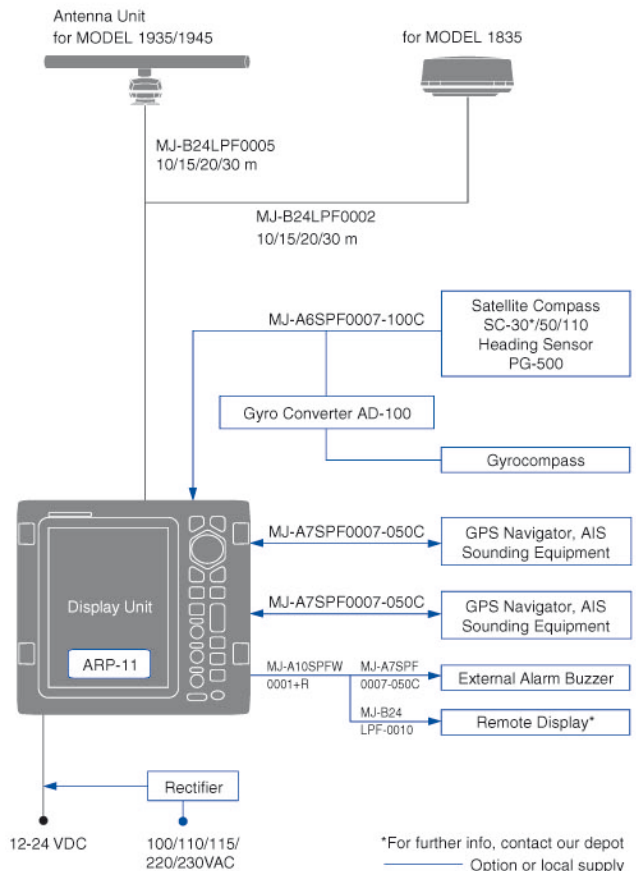

10.4 Multi-Color LCD RADAR MODEL 1835/1935/1945

SPECIFICATIONS OF MODEL 1835/1935/1945

ANTENNA RADIATOR

Type

MODEL 1835	Printed array
MODEL 1935/1945	Slotted waveguide array

Length and Rotation Speed

MODEL 1835	Radome 60 cm (ANT9210) 24 RPM
MODEL 1935	Open 100 cm (XN10A) 24 or 48 RPM
MODEL 1945	Open 120 cm (XN12A) 24 or 48 RPM

Wind Load (for MODEL 1935/1945)

24 RPM	100 kn relative wind
48 RPM	70 kn relative wind

Beamwidth

ANT9210:	Hor. 4.0°, Vert. 20°
XN10A:	Hor. 2.4°, Vert. 22°
XN12A:	Hor. 1.9°, Vert. 22°

RF TRANSCEIVER

Frequency 9410 ± 30 MHz (X-band)

Output Power

MODEL 1835/1935	4 kW
MODEL 1945	6 kW

DISPLAY

Screen Size 10.4" color LCD

Pixel Number 640 (H) x 480 (V), VGA

Effective Diameter 158 mm

Echo Colors 32 levels

Display Modes Head-up, Course-up*, North-up*, True view*, True motion**

* Heading data required

** Heading and position data required

Range Units nm, sm, km

Range Scales and Range Ring Intervals (nm)

Range: 1/16, 1/8, 1/4, 1/2, 3/4, 1, 1.5, 1.6, 2, 3, 3.2, 4, 6, 8, 12, 16, 24, 32, 36, 48*, 64**

Rings: 1/32, 1/16, 1/8, 1/4, 1/2, 0.8, 1, 2, 3, 4, 6, 8, 12*, 16**

* For MODEL 1935/1945

** For MODEL 1945

Minimum Range 25 m

Range Discrimination 25 m

Echo Trails

Type	True or relative trails
Trail Length:	15, 30 sec., 1, 3, 6, 15, 30 min., or continuous Trail
Trail Width:	Narrow, Normal

Plotting Facilities (Required optional board ARP-11)

Acquisition: Auto, Manual

Number of targets: 10 targets max

AIS Functions (Data input from AIS is required)

Symbols: Sleeping, Activated, Dangerous, Selected, Lost targets
Number of targets: 100 targets max.

INTERFACE

Input	AD-10 or IEC 61162 NMEA0183 Ver. 1.5/2.0/3.0
Output	IEC 61162 NMEA0183 Ver. 1.5/2.0/3.0

ENVIRONMENT

Temperature

Antenna Unit:	-25°C to +55°C (-13°F to +131°F)
Display Unit:	-15°C to +55°C (5°F to +131°F)

Waterproofing

Antenna Unit:	IEC60529 IP26
Display Unit:	IEC60529 IP55

POWER SUPPLY

MODEL 1835	12-24 VDC: 4.1-2.0 A
MODEL 1935	12-24 VDC: 6.8-3.3 A for 24 rpm 8.2-3.8 A for 48 rpm
MODEL 1945	12-24 VDC: 7.3-3.5 A for 24 rpm 8.8-4.1 A for 48 rpm

EQUIPMENT LIST

Standard

- Display Unit 1 unit
- Antenna Unit (Specify when ordering) 1 unit
- Antenna Cable
MODEL 1835 10, 15, 20 or 30 m 1 pc
MODEL 1935/1945 10, 15, 20 or 30 m 1 pc
- Power Cable 5 m 1 pc.
- Installation materials and spare parts 1 set

Option

- Auto Plotter ARP-11
- Rectifier
MODEL 1835 PR-62
MODEL 1935/1945 RU-3423
- External Alarm Buzzer OP03-21
- Interface Cable
MJ-B24LPF0010 10, 20, or 30 m
MJ-A7SPF0007-050C 5 m
MJ-A6SPF0007-100C 10 m
MJ-A10SPFW0001+R 0.2 m
- Antenna Bracket (for MODEL 1835) OP03-92

TRADEMARK REGISTERED
SPECIFICATIONS SUBJECT TO CHANGE WITHOUT NOTICE

FURUNO ELECTRIC CO., LTD.

Nishinomiya, Hyogo, Japan
Phone: +81 (0)798 65-2111
Fax: +81 (0)798 65-4200, 66-4622

FURUNO U.S.A., INC.

Camas, Washington, U.S.A.
Phone: +1 360-834-9300
Fax: +1 360-834-9400

FURUNO (UK) LIMITED

Havant, Hampshire, U.K.
Phone: +44 23 9244 1000
Fax: +44 23 9248 4316

FURUNO FRANCE S.A.S.

Bordeaux-Mérignac, France
Phone: +33 5 56 13 48 00
Fax: +33 5 56 13 48 01

FURUNO ESPAÑA S.A.

Madrid, Spain
Phone: +34 91-725-90-88
Fax: +34 91-725-98-97

FURUNO DENMARK AS

Hvidovre, Denmark
Phone: +45 36 77 45 00
Fax: +45 36 77 45 01

FURUNO NORGE A/S

Ålesund, Norway
Phone: +47 70 102950
Fax: +47 70 102951

FURUNO SVERIGE AB

Västra Frölunda, Sweden
Phone: +46 31-7098940
Fax: +46 31-497093

FURUNO FINLAND OY

Espoo, Finland
Phone: +358 9 4355 670
Fax: +358 9 4355 6710

FURUNO POLSKA Sp. z o.o.

Gdynia, Poland
Phone: +48 58 669 02 20
Fax: +48 58 669 02 21

FURUNO DEUTSCHLAND GmbH

Rellingen, Germany
Phone: +49 4101 838 0
Fax: +49 4101 838 111

FURUNO EURUS LLC

St. Petersburg, Russian Federation
Phone: +7 812 767 15 92
Fax: +7 812 766 55 52



09033U Printed in Japan
Catalogue No. R-196

