

# **FURUNO**

## **OPERATOR'S MANUAL**

*DOPPLER SONAR*

Model

**DS-60**

---

**FURUNO ELECTRIC CO., LTD.**

9-52 Ashihara-cho,  
Nishinomiya, 662-8580, JAPAN

• FURUNO Authorized Distributor/Dealer

All rights reserved. Printed in Japan

Pub. No. OME-72640-G2

(ETMI ) DS-60

A : MAR. 2010  
G2 : DEC. 13, 2022



0 0 0 1 7 2 3 3 4 1 6

# IMPORTANT NOTICES

---

## General

- This manual has been authored with simplified grammar, to meet the needs of international users.
- The operator of this equipment must read and follow the instructions in this manual. Wrong operation or maintenance can void the warranty or cause injury.
- Do not copy any part of this manual without written permission from FURUNO.
- If this manual is lost or worn, contact your dealer about replacement.
- The contents of this manual and the equipment specifications can change without notice.
- The example screens (or illustrations) shown in this manual can be different from the screens you see on your display. The screens you see depend on your system configuration and equipment settings.
- Save this manual for future reference.
- Any modification of the equipment (including software) by persons not authorized by FURUNO will void the warranty.
- The following concern acts as our importer in Europe, as defined in DECISION No 768/2008/EC.
  - Name: FURUNO EUROPE B.V.
  - Address: Siriusstraat 86, 5015 BT, Tilburg, The Netherlands
- The following concern acts as our importer in UK, as defined in SI 2016/1025 as amended SI 2019/470.
  - Name: FURUNO (UK) LTD.
  - Address: West Building Penner Road Havant Hampshire PO9 1QY, U.K.
- All brand, product names, trademarks, registered trademarks, and service marks belong to their respective holders.

## How to discard this product

Discard this product according to local regulations for the disposal of industrial waste. For disposal in the USA, see the homepage of the Electronics Industries Alliance (<http://www.eiae.org/>) for the correct method of disposal.

## How to discard a used battery

Some FURUNO products have a battery(ies). To see if your product has a battery, see the chapter on Maintenance. If a battery is used, tape the + and - terminals of the battery before disposal to prevent fire, heat generation caused by short circuit.

### In the European Union

The crossed-out trash can symbol indicates that all types of batteries must not be discarded in standard trash, or at a trash site. Take the used batteries to a battery collection site according to your national legislation and the Batteries Directive 2006/66/EU.

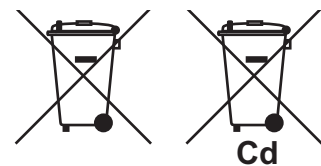

### In the USA

The Mobius loop symbol (three chasing arrows) indicates that Ni-Cd and lead-acid rechargeable batteries must be recycled. Take the used batteries to a battery collection site according to local laws.

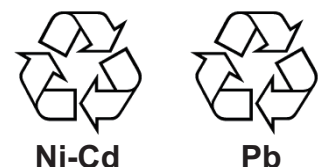

### In the other countries

There are no international standards for the battery recycle symbol. The number of symbols can increase when the other countries make their own recycle symbols in the future.



# SAFETY INSTRUCTIONS

Please read these safety instructions before you operate the equipment.



## WARNING

Indicates a condition that can cause death or serious injury if not avoided.



## CAUTION

Indicates a condition that can cause minor or moderate injury if not avoided.



Warning, Caution



Prohibitive Action



Mandatory Action



## WARNING



**Do not open the equipment.**

This equipment uses high voltage that can cause electrical shock. Only qualified persons can work inside the equipment.



**Turn off power at the switchboard if something is dropped inside the equipment or water leaks into the equipment.**

Fire or electrical shock can result if the power remains on.



**Turn off the power at the switchboard if the equipment is emitting smoke or fire.**

Fire or electrical shock can result if the power remains on.



**Do not disassemble or modify the equipment.**

Fire, electrical shock or bodily injury can result.



## WARNING



**Do not put liquid-filled containers on or near the equipment.**

Fire or electrical shock can result if a liquid spills into the equipment.



**Do not operate the equipment with wet hands.**

Fire or electrical shock can result.



**If you feel the equipment is abnormal or is giving off strange noises, turn off the power at the switchboard immediately. Contact a FURUNO agent or dealer for advice.**



**Do not allow rain or water splash to get into the equipment.**





Fire or electrical shock can result.





**Use the correct fuse.**

Use of a wrong fuse can cause bodily injury or fire.



 <b>CAUTION</b>	
	<p><b>If an LCD-type display is used, handle the display with care.</b></p> <p>The panel is made of glass which, if broken, can cause injury.</p>
	<p><b>Do not paint the transducer .</b></p> <p>Paint causes a large drop in sensitivity.</p>
	<p><b>Do not power the equipment when the transducer is in air.</b></p> <p>The transducer can become damaged.</p>
	<p><b>Remove marine life from the face of the transducer when the ship is dry-docked.</b></p> <p>Marine life can affect sensitivity.</p>

 <b>CAUTION</b>	
	<p><b>If the optional rate gyro is installed, power the system when the ship is stationary or is traveling in a straight line.</b></p> <p>The point of reference for the rate gyro is determined when the system is powered. If the ship is turning at that time, the point of reference will be wrong and the gyro indication in error. When the rate gyro goes off (power outage, etc.), make sure the ship is stationary or traveling in a straight line before turning on the rate gyro.</p>

**Warning Label**

Warning label(s) is(are) attached to the equipment. Do not remove the label(s). If a label is missing or damaged, contact a FURUNO agent or dealer about replacement.

 <b>WARNING</b> 
To avoid electrical shock, do not remove cover. No user-serviceable parts inside.
 <b>警告</b> 
<p>感電の恐れあり。 サービスマン以外の方はカバーを開けないで下さい。内部には高電圧部分が多い数多くあり、万一さわると危険です。</p>

Name: Warning Label (1)  
Type: 86-003-1011-3  
Code No.: 100-236-233-10

# TABLE OF CONTENTS

---

<b>FOREWORD .....</b>	<b>vi</b>
<b>SYSTEM CONFIGURATION .....</b>	<b>viii</b>
<b>1. INTRODUCTION .....</b>	<b>1-1</b>
1.1 Controls.....	1-1
1.1.1 Display Unit DS-600.....	1-1
1.1.2 Remote Controller RD-501 (option) .....	1-3
1.1.3 Dimmer Controller RD-502 (option) .....	1-3
1.2 How to Turn the Power On and Off.....	1-4
1.3 How to Adjust the Screen Brilliance .....	1-5
1.4 How to Select a Display .....	1-5
1.5 How to Select a Tracking Mode .....	1-6
1.6 How to Change Units of Measurement .....	1-7
1.7 How to Reset the Trip Distance Indication .....	1-8
1.8 How to Select Daytime and Nighttime Displays .....	1-9
1.9 General Menu Operation.....	1-9
<b>2. NAVIGATION DATA DISPLAY.....</b>	<b>2-1</b>
2.1 Navigation Data Display Overview.....	2-1
2.1.1 Description of indications .....	2-2
2.2 How to Set Navigation Data .....	2-3
2.2.1 Time .....	2-3
2.2.2 Time format.....	2-4
2.2.3 Depth measurement reference .....	2-6
2.2.4 Current direction.....	2-6
2.2.5 Wind angle/direction.....	2-8
2.2.6 Wind averaging time .....	2-9
2.2.7 ROT sensor.....	2-9
2.3 How to Set the Speed Alarm.....	2-10
<b>3. BERTHING DISPLAY .....</b>	<b>3-1</b>
3.1 Berthing Display Overview .....	3-1
3.2 Display Range.....	3-3
3.2.1 How to select a range .....	3-3
3.2.2 How to pre-set ranges.....	3-3
3.3 Track .....	3-4
3.3.1 Types of tracks.....	3-4
3.3.2 How to select the type of track to display.....	3-5
3.3.3 How to select the past track format.....	3-6
3.3.4 How to select the predicted track plot interval.....	3-6
3.4 How to Select Vector Time.....	3-7
3.5 How to Show, Hide Navigation Data and 3-axis Speed Data .....	3-8
3.6 Berthing Line.....	3-9
3.6.1 How to create a berthing line .....	3-9
3.6.2 How to share berthing lines with sub display units.....	3-13
3.6.3 How to delete a berthing line.....	3-14
<b>4. SPEED GRAPHIC DISPLAY .....</b>	<b>4-1</b>
4.1 Speed Graphic Indications .....	4-1
4.2 How to Set the Speed Graphic.....	4-2
4.3 How to Select the Display Format for the Speed Graphic.....	4-3
4.4 How to Change the Speed Graphic Format .....	4-5

<b>5. OTHER OPERATIONS .....</b>	<b>5-1</b>
5.1 How to Set the Displays .....	5-1
5.2 Key Beep On/Off .....	5-4
5.3 How to Adjust Key Dimmer.....	5-4
5.4 How to Select Direction Symbol Format.....	5-5
5.5 How to Select the Location for the Direction Symbols.....	5-6
5.6 Total Distance Run .....	5-7
5.6.1 How to reset total distance run .....	5-7
5.6.2 How to set total distance run .....	5-8
5.7 System Parameters .....	5-9
<b>6. MAINTENANCE .....</b>	<b>6-1</b>
6.1 Maintenance .....	6-1
6.2 Consumable Parts .....	6-2
6.2.1 Fuse replacement.....	6-2
6.2.2 Product life .....	6-2
6.3 Troubleshooting.....	6-3
6.4 Alert Modes and Messages.....	6-3
6.4.1 Alert messages.....	6-4
6.5 Diagnostics .....	6-5
6.5.1 System test.....	6-5
6.5.2 Display unit test .....	6-9
6.5.3 LCD test .....	6-10
6.6 TX Monitor .....	6-11
6.7 Echo Monitor .....	6-12
6.8 How to Restore Initial Settings .....	6-14
<b>APPENDIX 1 MENU TREE .....</b>	<b>AP-1</b>
<b>APPENDIX 2 ABBREVIATIONS.....</b>	<b>AP-3</b>
<b>APPENDIX 3 ALERT LIST.....</b>	<b>AP-6</b>
<b>APPENDIX 4 PARTS LIST, PARTS LOCATION .....</b>	<b>AP-7</b>
<b>SPECIFICATIONS .....</b>	<b>SP-1</b>
<b>INDEX .....</b>	<b>IN-1</b>

# FOREWORD

---

## A Word to the Owner of the DS-60

Congratulations on your choice of the DS-60 Doppler Sonar. We are confident you will see why the FURUNO name has become synonymous with quality and reliability.

Since 1948, FURUNO Electric Company has enjoyed an enviable reputation for innovative and dependable marine electronics equipment. This dedication to excellence is furthered by our extensive global network of agents and dealers.

Your equipment is designed and constructed to meet the rigorous demands of the marine environment. However, no machine can perform its intended function unless properly operated and maintained. Please carefully read and follow the operation and maintenance procedures set forth in this manual.

Thank you for considering and purchasing FURUNO.

## Features

The DS-60 is a high precision Doppler Sonar designed for use on VLCC, LNG, LPG, container ships, cargo ships, etc. The DS-60 measures speeds relative to ground and water in the fore, stern and transverse directions. This arrangement provides for precision docking of tankers and the like to loading and unloading facilities, as well as safe navigation in narrow channels and straits.

- Meets the requirements of IEC 61023 Ed 3.0, IEC 60945 Ed 4th, IEC 61162-1 Ed.5.0 and IEC62923-1/2 Ed 1.0.
- Measurement accuracy of  $\pm 0.01$  m/s.
- Ground tracking from 1-200 m for accurate ground speed in coastal waters.
- Sub display units (max. 5) for display on the wing, etc.

## Program Numbers (xx denotes minor change)

Unit	Program	Number
<b>DS-600</b>	Starter	6652000-01.xx
	Booter	6652001-02.xx
	Main	6652002-02.xx
<b>DS-610</b>	Starter	6652100-01.xx
	Booter	6652101-02.xx
	Main	6652102-02.xx
	FPGA	6652103-00.xx
<b>DS-620</b>	Starter	6652200-01.xx
	Booter	6652201-02.xx
	Main	6652202-02.xx
	FPGA1	6652203-00.xx
	FPGA2	6652204-00.xx
<b>RD-501, RD-502</b>	2651009-01.xx	

## Remarks on usage of the DS-60

The DS-60 measures ship's speed by detecting the Doppler shift frequency of the echo reflected by a watermass (water layer containing plankton and other micro-organisms) located within the measuring area, which is usually about 2 m. In some instances, however, no signal is returned because of too few plankton in the sensing depths. This phenomenon can occur in particular areas in particular seasons. The probable cause is the plankton are lying in deep water because an ice-melted cold water mass covers the sea surface. Similar cases may also occur in a freshwater lake. Under these circumstances the DS-60 will not show the correct ship's speed.

## Conditions which may affect accuracy (with ref. to IMO A.824/3.3)

The Doppler speed log DS-60 is designed for reliable and accurate performance through FURUNO's long experience and advanced technology. It operates on the best choice of system frequency and power output.

As far as the sonic energy is used, the performance (accuracy) may be reduced or even lost under:

- rough weather (may be sea state 6 or severer)
- improper location of sensor (e.g., too close to the propeller, thrusters, drain tubes, echo sounder equipment)
- depth under the keel, if less than 3m

The accuracy will not be affected by:

- water temperature (sound velocity)
- salinity
- pitch/roll  $\pm 10^\circ$

## Beware of transducer location

The transducer may be damaged if it hits the dry dock blocks. Take the following measures to prevent damage to the transducer.

1. Before delivering the ship, draw up a suitable docking plan taking into account the dimensions and location of the transducer. Store the plans onboard the ship.
2. Place the dry dock blocks according to the plan.
3. Have a diver check the position between the transducer and the blocks before removing the water. Confirm that the transducer will not touch the blocks.

## CE/UKCA declaration

With regards to CE/UKCA declarations, please refer to our website ([www.furuno.com](http://www.furuno.com)) for further information about RoHS conformity declarations.

## Disclosure of Information about China RoHS

With regards to China RoHS information for our products, please refer to our website ([www.furuno.com](http://www.furuno.com)).

# SYSTEM CONFIGURATION

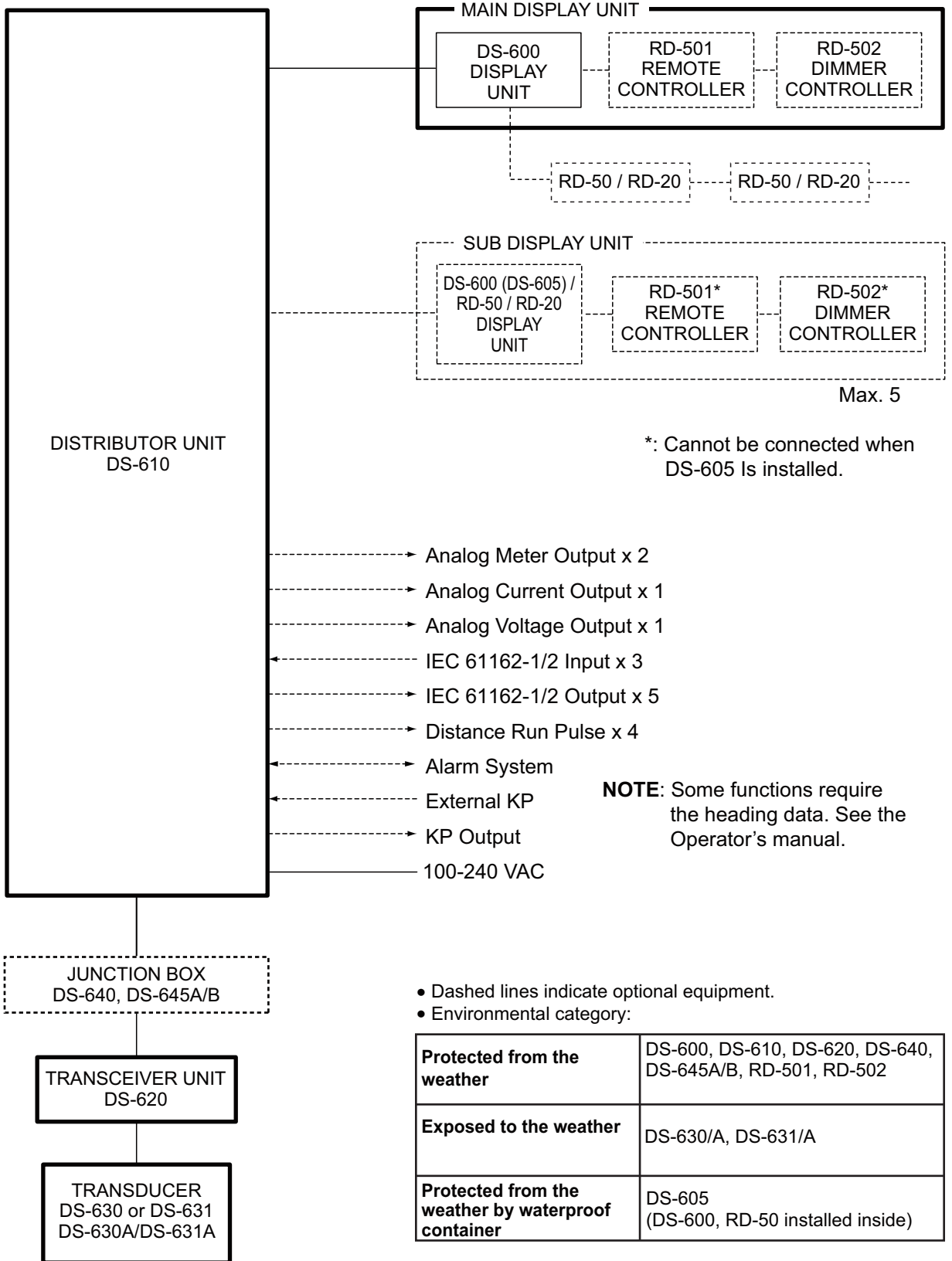

# 1. INTRODUCTION

This chapter provides the information necessary to get you started with the system.

The display unit has ten keys that respond immediately to your command. When you operate a key, a single beep sounds. If you do not need the beep, you can deactivate the beep from the menu.

## Standards used in this manual

The control names are shown in bold face, for example, “**DISP** key”. Menu-related items are in brackets, for example, [Key Beep].

## 1.1 Controls

### 1.1.1 Display Unit DS-600

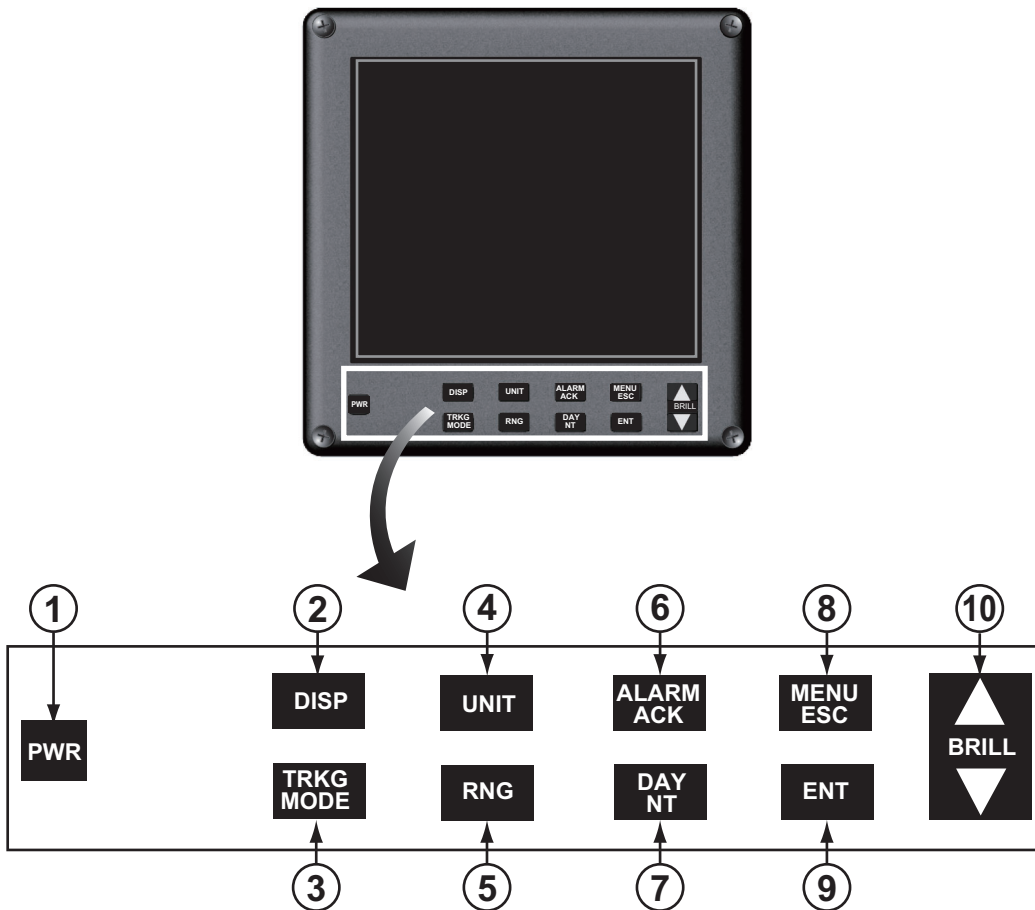

No.	Control	Function
1	PWR	Turn the power on and off.
2	DISP	<ul style="list-style-type: none"> <li>Select a display.</li> <li>Close the menu and return to last-used display.</li> <li>In multiple data displays, select a data indication to change its unit of measurement (with the <b>UNIT</b> key).</li> </ul>

1. INTRODUCTION

No.	Control	Function
3	TRKG MODE	<ul style="list-style-type: none"> <li>• <b>Main display unit:</b> Select the tracking mode (water, ground, or auto) for the measurement of ship's speed.</li> <li>• <b>Sub display unit:</b> Select the ship speed mode between SOG and STW when the tracking mode at the main display is ground tracking.</li> </ul>
4	UNIT	Select the unit of measurement for speed, depth, distance, current (tide) speed, wind speed, etc.
5	RNG	Select the range in the berthing and echo monitor displays.
6	ALARM ACK	For main display unit only, long-push to display the Active Alert List (see page 6-4).
7	DAY/NT	Select the daytime and nighttime displays alternately.
8	MENU/ESC	<ul style="list-style-type: none"> <li>• Open the menu.</li> <li>• Return control to the menu window without making any changes at the menu options window.</li> <li>• Select the item to change its unit of measurement in multiple data displays.</li> <li>• Close the menu when the menu window is active.</li> </ul>
9	ENT	<ul style="list-style-type: none"> <li>• Confirm an operation in menu operation.</li> <li>• Long-push to hide or show nav data and 3-axis speed data in the berthing display.</li> <li>• Long-push to reset the trip distance on the displays that show trip distance.</li> </ul>
10	BRILL	<ul style="list-style-type: none"> <li>• Adjust the screen brilliance. ▼ to decrease the brilliance, ▲ to increase the brilliance. To quickly increase or decrease the brilliance, press and hold the related key. The default setting is 9.</li> <li>• Move the cursor in menu operation.</li> </ul>



### 1.1.2 Remote Controller RD-501 (option)

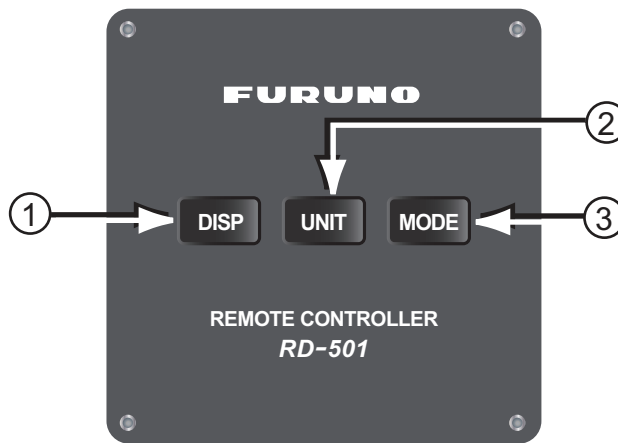

No.	Control	Function
1	DISP	<ul style="list-style-type: none"> <li>Select a display.</li> <li>Close the menu and return to last-used display.</li> <li>In multiple data displays, select a data indication to change its unit of measurement (with the <b>UNIT</b> key).</li> </ul>
2	UNIT	Select the unit of measurement for speed, depth, distance, current (tide) speed, wind speed, etc.
3	MODE	<ul style="list-style-type: none"> <li><b>Main display unit:</b> Select the tracking mode (ground, water, or auto) for the measurement of ship speed.</li> <li><b>Sub display unit:</b> Select the tracking mode to ground tracking or water tracking when the tracking mode at the main display unit is ground tracking or auto tracking.</li> </ul>

### 1.1.3 Dimmer Controller RD-502 (option)

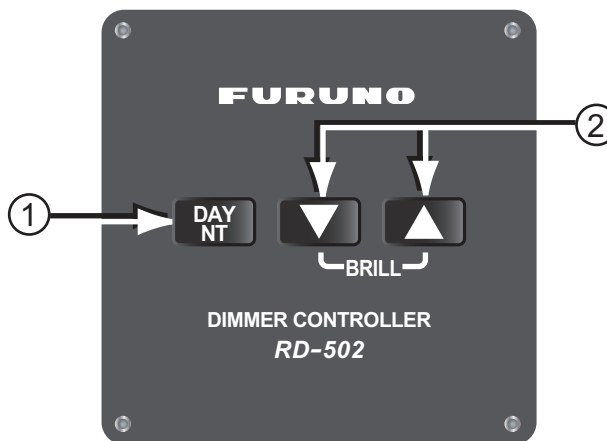

No.	Control	Function
1	DAY/NT	Select the daytime and nighttime displays alternately.
2	▼, ▲	Adjust the screen brilliance. ▼ to decrease the brilliance, ▲ to increase the brilliance. To quickly increase or decrease the brilliance, press and hold the related key.

## 1.2 How to Turn the Power On and Off

Press the **PWR** key to turn on the power.

The main display unit shows the serial numbers, program numbers and results of the RAM and ROM checks (OK or NG) for the Display Unit DS-600, Distributor Unit DS-610, and Transceiver Unit DS-620. The sub display unit shows its serial number, program number and results of the ROM and RAM check, "OK" or "NG" (No Good). The table below shows the average time required for each test.

Unit	Average time required
DS-610	20 seconds
DS-620	25 seconds

After the program numbers appear and the test results are displayed, "Now calibrating..." is displayed momentarily on the main display unit, the start-up screen is erased, then the last-used display appears. This process takes approximately 70 seconds to complete.

**Note:** If "NG" appears as the RAM or ROM check result, the equipment stops. Reset the power to try to restore normal operation. If you cannot restore normal operation, contact a FURUNO agent or dealer for instruction.

To turn off the power, press the **PWR** key.

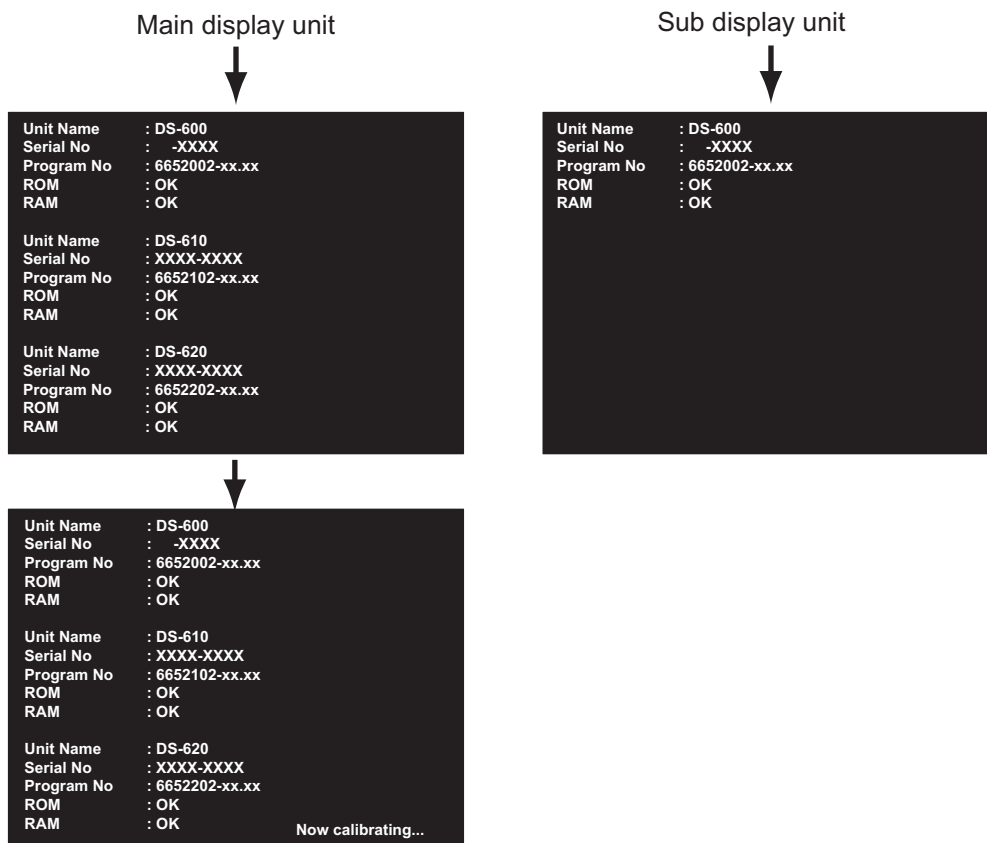

**Note:** The screen refreshes slower in low ambient temperature.

### 1.3 How to Adjust the Screen Brilliance

You can adjust the brilliance of the display screen from the display unit and the Dimmer Controller, in 10 levels including off. Press ▲ to increase the brilliance, or press ▼ to decrease the brilliance. To quickly change the brilliance, press and hold the related arrow. The default brilliance setting is [9].

If the Remote Display RD-50 (sub display unit) is connected to the display unit of the DS-60 in a daisy chain, their brilliances are mutually adjusted when you adjust the brilliance from the DS-60.

### 1.4 How to Select a Display

Press the **DISP** key to select a display. In the default arrangement there are five displays: navigation data, berthing (head-up), heading and speed, trip distance and total distance, and speed analog data (sub display only).

A maximum of seven displays are available, in full screen or two-way horizontal split screen. Section 5.1 shows you to set the displays to meet your requirements.

When a data is lost, hyphens; for example, “- .-”, replace the lost data. When a data is in error, its unit (kn, etc.) is shown in white characters on a yellow background. The “normal” unit appears again when the data returns.

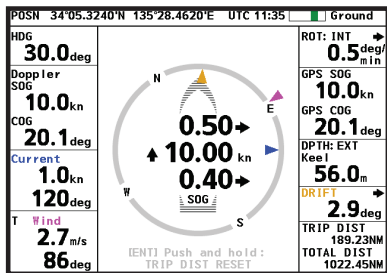

Navigation data display

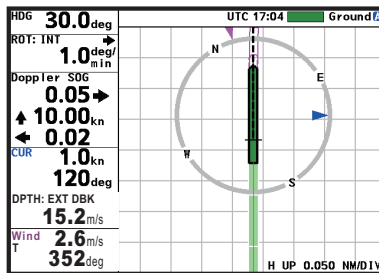

Berthing display (head-up)

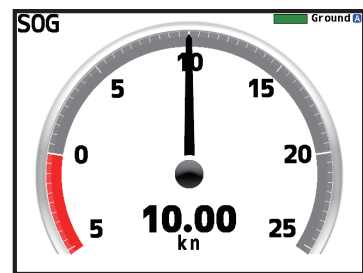

Speed analog display (sub display only)

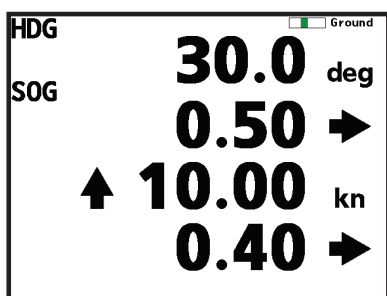

Heading, speed data display

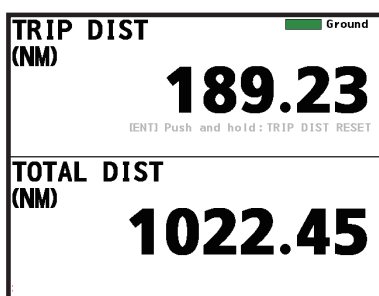

Trip distance, total distance run display

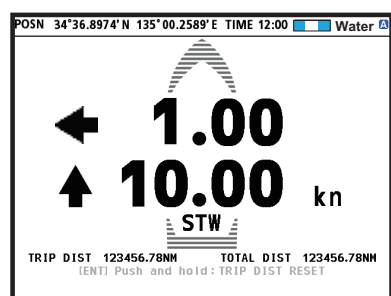

2-axis speed/distance display

Default displays

## 1.5 How to Select a Tracking Mode

Press the **TRKG MODE** key (main display unit) or the **MODE** key (Remote Controller) to select a tracking mode, among ground, water and auto. Select the mode according to the depth and speed. The tracking mode indication, Ground, Water, or **A** (Auto), appears at the top-right corner.

The tracking mode monitor (bar) at the top of the display shows the history of tracking modes for the past three minutes. The bar is updated every three seconds and scrolls leftward. The color of the bar is green for ground tracking, blue for water tracking, and background color when there is no echo input.

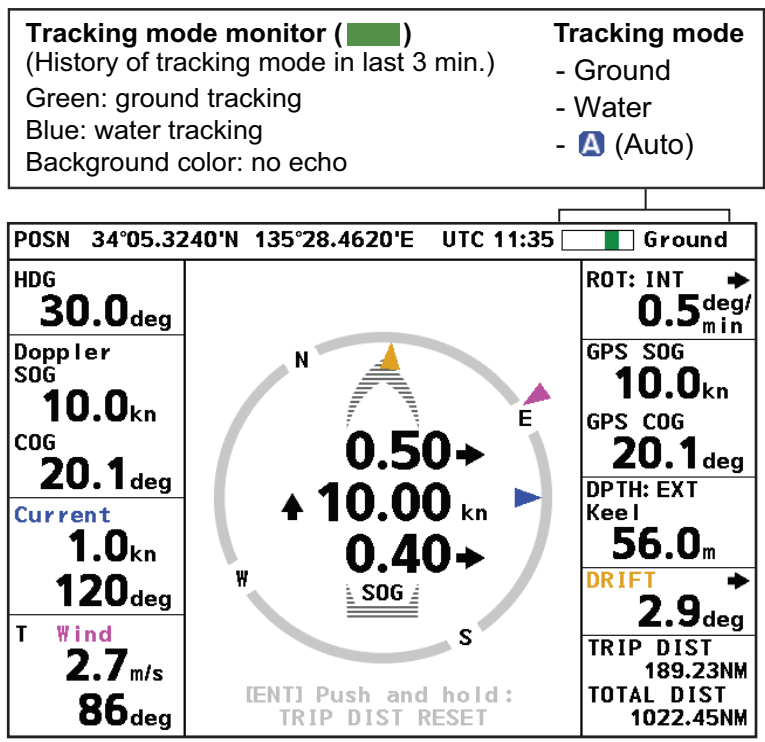

### Description of tracking modes

**Ground:** Measure and display a speed relative to the sea bottom. The depth from the keel must be 1-200 m to use this mode.

**Water:** Measure and display a speed relative to the water mass. The depth from the keel must be at least three meters to use this mode. However, the accuracy is lower when the clearance is less than 40 m. The reference layer can be set with [Track Depth] on the [System menu]. See section 5.7.

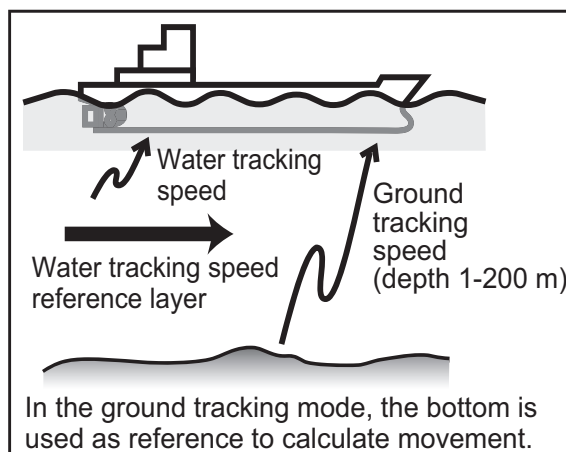

**Auto:** Automatically selects ground tracking mode or water tracking mode according to the depth. The water tracking mode is selected when the keel clearance is 200 m or more. (Actual working depth in the ground tracking mode depends on the bottom and water conditions, and the reflection properties for sonic pulses.)

## 1.6 How to Change Units of Measurement

The **UNIT** key selects the unit of measurement for current (tide) speed, depth, distance, Doppler SOG and STW, GPS SOG, and wind speed.

### Single data display

Press the **UNIT** key to select a unit of measurement.

### Multiple data display

1. Press the **UNIT** key. A unit is highlighted in yellow.  
In the example of the navigation data display shown below, the speed unit is highlighted.

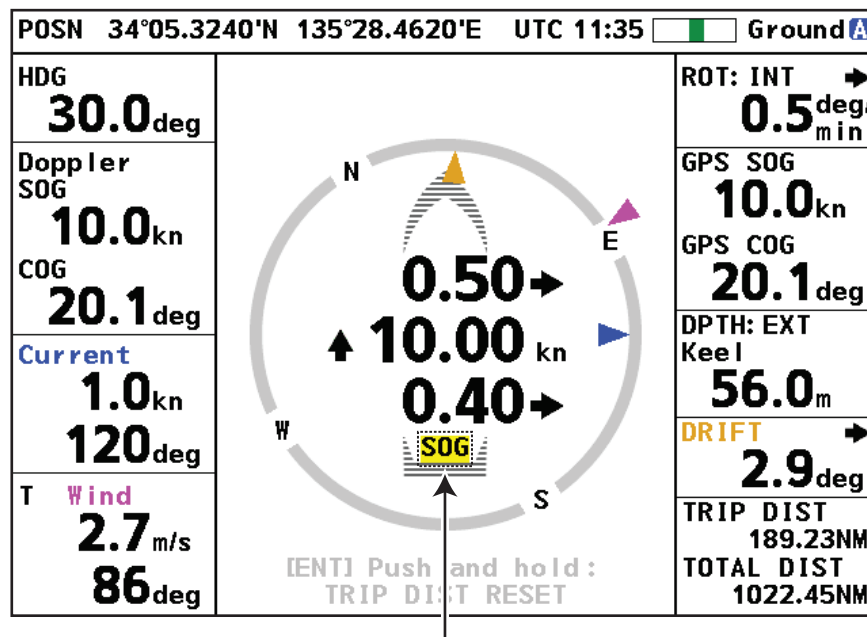

Highlight (yellow)

2. Press the **DISP** key to select the data for which to change its unit. (Use the **MENU/ESC** key to reverse the selection order.)
3. Press the **UNIT** key to change the unit. See the table below for item and available units.

Item	Available units
Berthing display range	meters/DIV (m/DIV), nautical miles/DIV (NM/DIV)
Current (tide) speed	knots (kn), meters/second (m/s)
Distance	kilometers (km), nautical miles (NM)
Depth	fathoms (fm), feet (ft), meters (m)
Ground tracking (SOG) Water tracking (STW)	kilometers/hour (km/h), knots (kn), meters/second (m/s)
Wind speed	knots (kn), meters/second (m/s), miles/hour (mph)

To quit the unit selection, press the **DISP** or **MENU/ESC** key until the yellow highlight disappears.

## 1.7 How to Reset the Trip Distance Indication

You can reset the trip distance indication on the displays that shows the trip distance. Press the **ENT** key until the trip distance indication shows all zeros. (Trip distance can also be reset from the menu, with [Trip DIST]→ [RESET].)

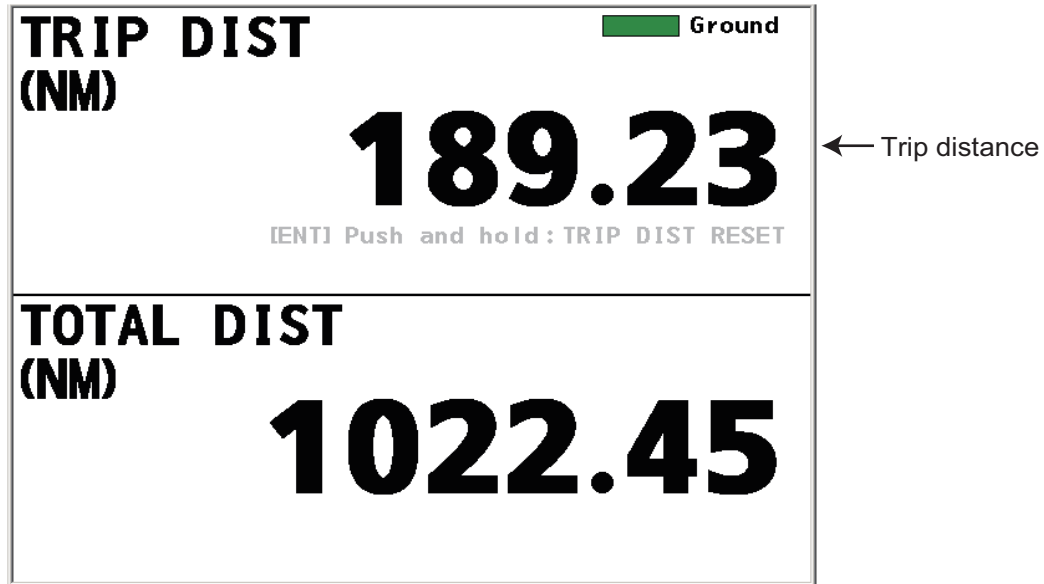

Trip distance, total distance display

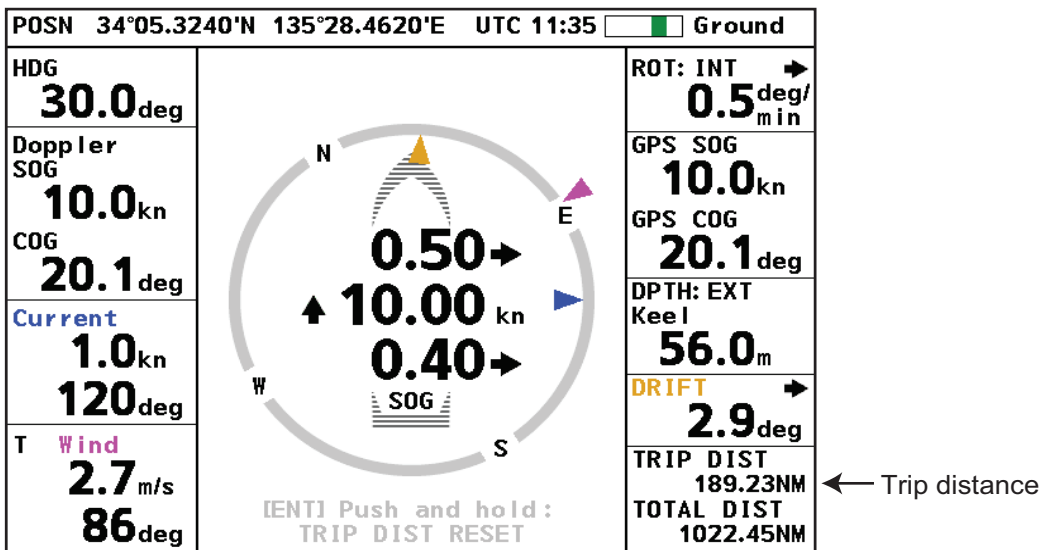

Navigation data display

## 1.8 How to Select Daytime and Nighttime Displays

The **DAY/NT** key selects the daytime (black characters on a white background) and nighttime (white characters on a black background) displays alternately, for comfortable viewing according to the time of day.

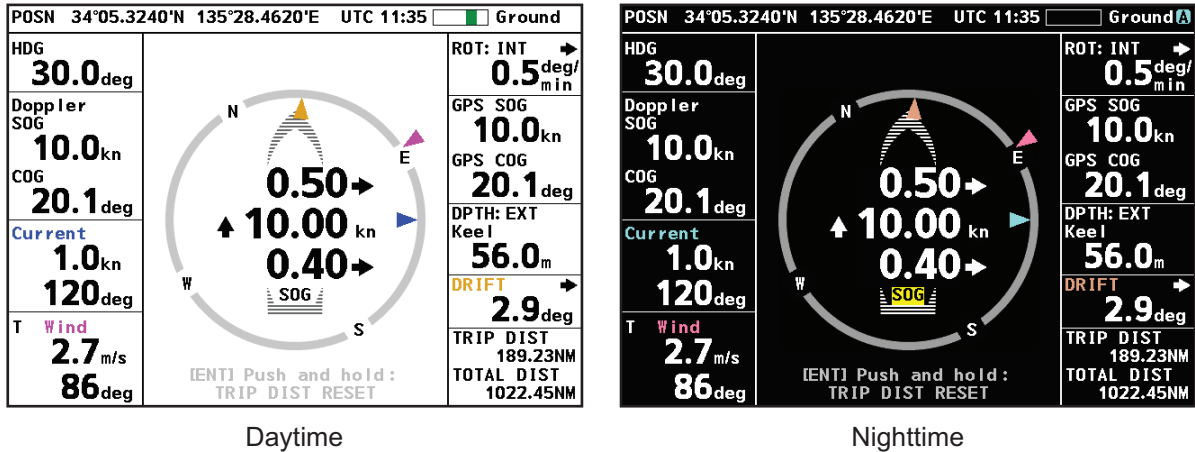

## 1.9 General Menu Operation

This section shows basic menu operation procedures.

1. Press the **MENU/ESC** key to open the menu. The menu window and the menu options window for the currently selected menu item appear.

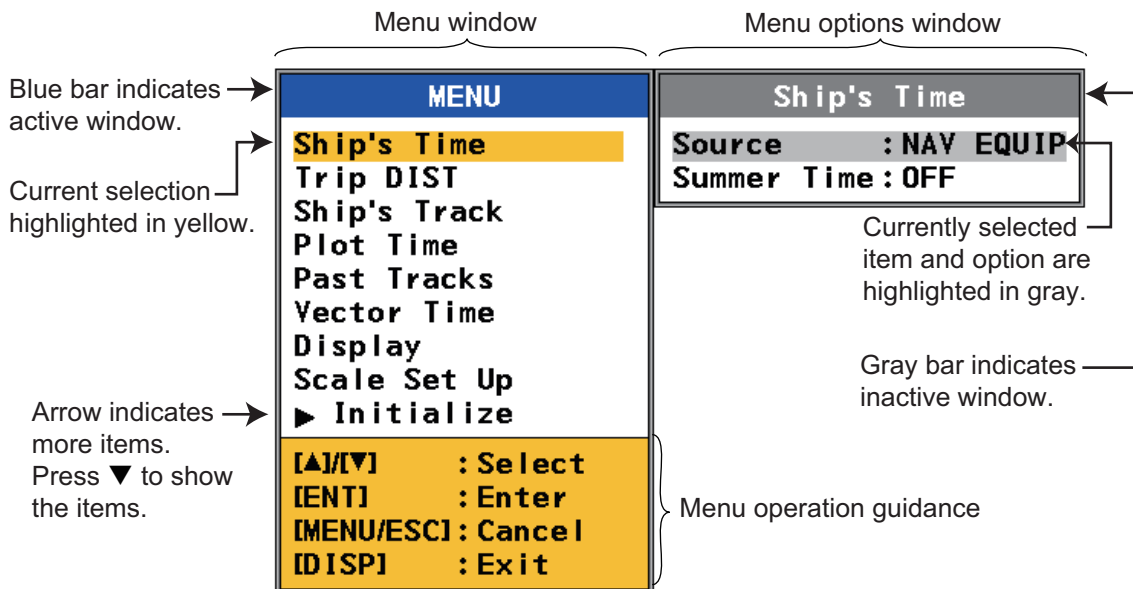

2. Press **▲**, **▼** to select a menu item then press the **ENT** key. Control is then given to the menu options window.

**Note 1:** Hereafter we write “Select [name of menu item] then press the **ENT** key.” where you use **▲**, **▼** to select an item or option and the **ENT** key to confirm selection.

**Note 2:** A short beep sounds when settings could not be applied because of communication error. Check settings after restoring normal operation.

1. INTRODUCTION

- Select an item from the menu options window then press the **ENT** key. One of the four types of boxes shown below appears. Follow the related procedure to make your selection.

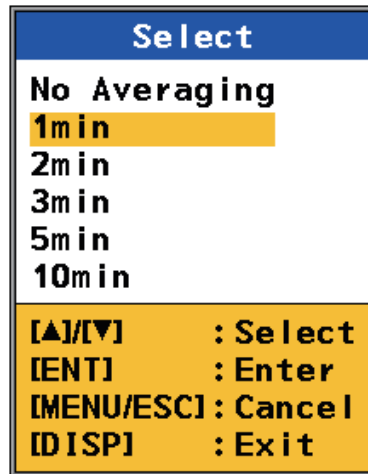

List box

- Select option with ▲, ▼.
- Press **ENT** key.

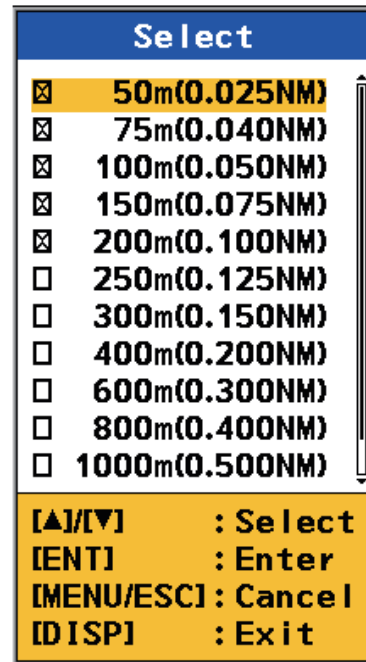

Check box

- Select option with ▲, ▼.
- Press **ENT** key to check or uncheck box.

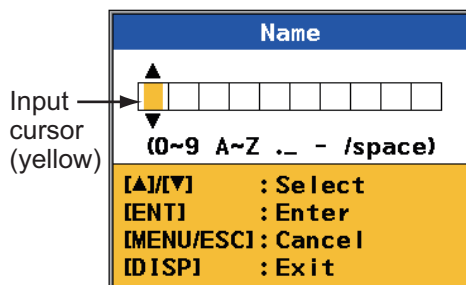

Spinner box(alphanumeric data)

The input cursor is initially at the far-left position.

- Select character with ▲, ▼.
- Press **ENT** key to confirm.  
The input cursor moves to next input point.
- Repeat steps 1 and 2 to complete the name.

You can move the input cursor with **ENT**, **MENU/ESC**.

**ENT**: Move right.

**MENU/ESC**: Move left.

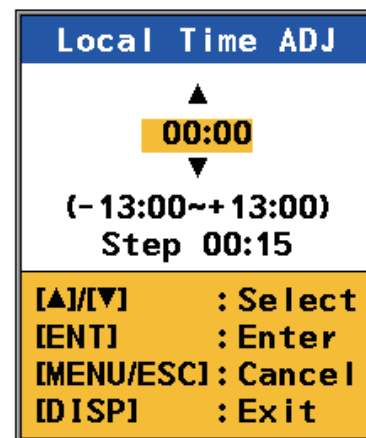

Spinner box(numeric data)

- Set value with ▲, ▼.
- Press **ENT** key to confirm.

- Control is returned to the menu window. Press the **DISP** key to close the menu.



# 2. NAVIGATION DATA DISPLAY

## 2.1 Navigation Data Display Overview

The navigation data display provides comprehensive navigation data (with connection of related sensors) and a 3-axis speed display. When a data is lost, its numerical indication is shown with hyphens; for example, “---.”. When a data is in error, its unit; for example, “kn,” is shown in white characters on a yellow background. The “normal” unit appears again when the data returns.

The 3-axis speed display mainly shows transverse speed at the reference point, longitudinal speed and transverse speed at the stern. The direction indicators can be shown with arrows or text, selectable from the menu. Wind angle, drift angle and current (tide) direction are indicated with purple, brown and blue triangles, respectively.

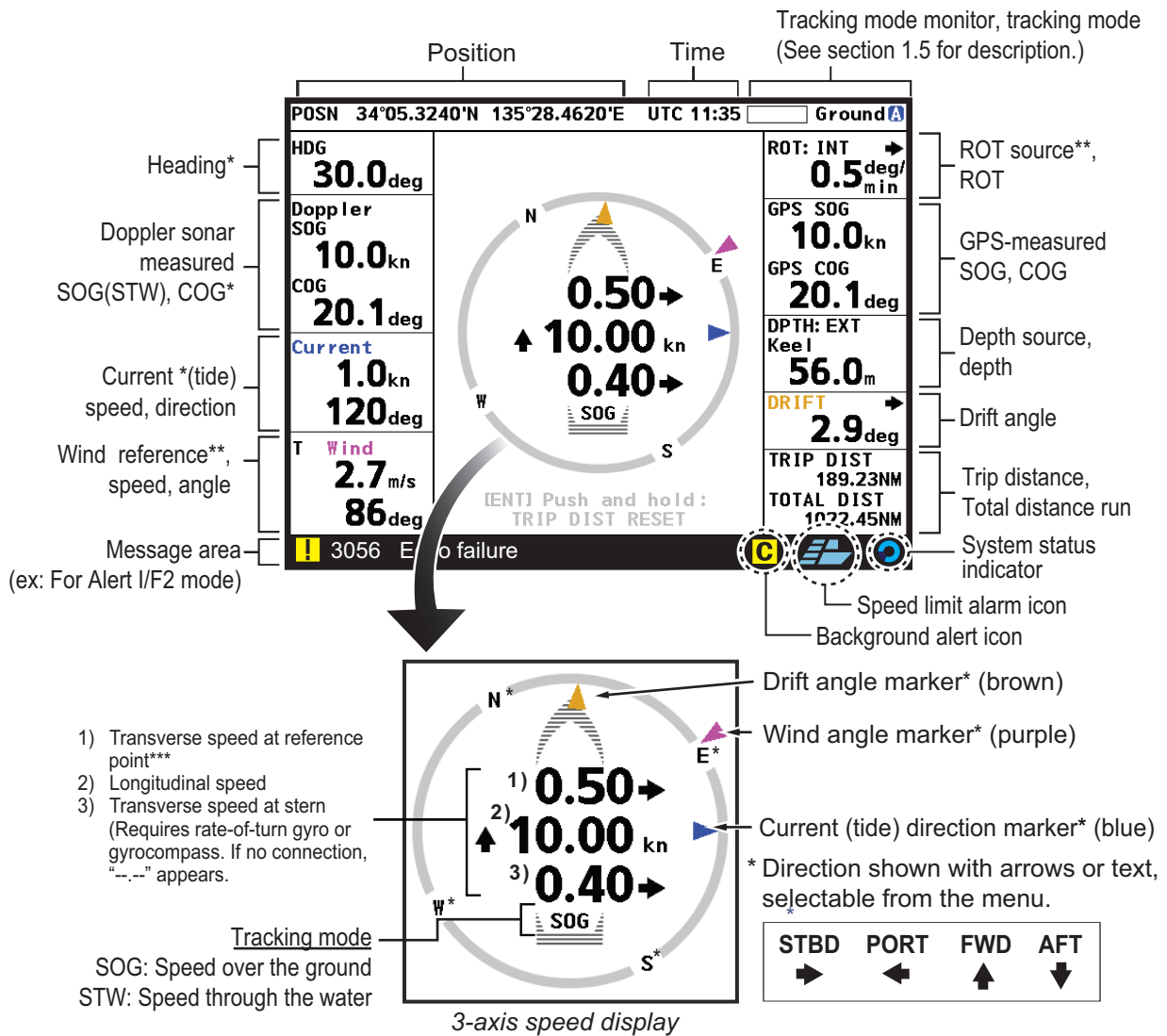

\*: Requires heading data. If there is no heading data, “---” appears and the ▲ mark and “NSEW” (indicates the azimuth) are not shown.  
 \*\*: ROT: Heading data is required only for [EXT HDG]. WIND: Heading data is required only for [True].  
 \*\*\*: The reference point (Bow, Transducer or Center) is set at installation.

### 2.1.1 Description of indications

Descriptions in clockwise order from top-left corner.

Indication	Description
<b>POSN</b>	Latitude and longitude position of your ship, input by a position-fixing equipment (GPS, etc.).
<b>Time</b>	Time, input by a position-fixing equipment, is available in UTC or local time, selectable from the menu. The time format is shown before the time, "UTC" for Universal Coordinated Time, or "TIME" for local time. Daylight savings time can be activated and deactivated from the menu.
<b>Tracking monitor</b>	Show the history of the tracking mode in the last three minutes. See section 1.5.
<b>Tracking mode</b>	Show the current tracking mode: Ground, Water, or Auto. See section 1.5.
<b>ROT</b>	Source of ROT (Rate of Turn) and ROT value. The source of ROT can be selected from the menu. See section 2.2.7.
<b>GPS SOG</b>	GPS-measured speed over the ground. When the GPS signal is lost, "--.-" appears.
<b>GPS COG</b>	GPS-measured course over the ground. When the GPS signal is lost, "---.-" appears.
<b>DPTH</b>	Depth can be shown from the transducer or from the keel (fed from external source), selectable from the menu. <b>Note:</b> The ultrasound beam is injected into water at an angle. The returning echo from a bottom arrives at an angle to the transducer and is converted into a downward-measured depth. The depth measured to a flat bottom meets the accuracy denoted in the specifications, however the depth to a sloping bottom is not the "true" depth because the average depth measured by three beams is shown.
<b>DRIFT</b>	Drift angle. The drift angle is shown on the 3-axis speed display with a brown triangle.
<b>TRIP DIST</b>	Trip distance indication.
<b>TOTAL DIST</b>	Total distance run indication. You can reset and adjust the indication from the menu.
<b>Wind</b>	Wind reference, speed and angle, input by a wind-measuring device. The wind angle is shown on the 3-axis speed display with a purple triangle. Wind reference (T: True, TH: Theoretical, R: Relative) and wind averaging time can be set on the menu. See section 2.2.5 for details.
<b>Current</b>	Current (tide) speed and direction. The direction of the current is shown in the 3-axis speed display with a blue triangle. This graphic can show the direction the current is flowing from, or the direction the current is flowing to. The blue triangle is inside the 3-axis speed display when the direction is "flowing to", and outside that display when the direction is "flowing from". You can set the indication method on the menu. See section 2.2.4.
<b>Doppler SOG (or STW)</b>	Doppler sonar-measured speed over the ground or speed through the water.
<b>Doppler COG</b>	Doppler sonar-measured course over the ground.
<b>HDG</b>	Current heading, input by a gyrocompass. "---.-" appears if there is no gyrocompass connected.
<b>Message area</b>	Alerts are displayed here in priority order.
<b>Back-ground alert icon</b>	Displays when one or more alerts, other than the alert displayed in the message area, are generated.

Indication	Description
<b>Speed limit alarm icon</b>	Displays if the speed of the ship speed is higher than [Speed Limit Alarm] setting (other than [OFF]). See section 2.3 for [Speed Limit Alarm] setting.
<b>System status indicator</b>	The system status indicator moves in a circular motion to indicate that the system is functioning normally. When the indicator stops moving, it may mean there is a problem with the system (screen freeze, etc.). Restart the system. If this fails, consult your local FURUNO dealer.

## 2.2 How to Set Navigation Data

### 2.2.1 Time

This section shows you how to select the source for time, set local time, and turn summer time indication (daylight savings time) on or off.

1. Press the **MENU/ESC** key to open the menu.
2. Select [Ship's Time] then press the **ENT** key.

Ship's Time	
<b>Source</b>	: NAV EQUIP
<b>Summer Time</b>	: OFF
[▲]/[▼]	: Select
[ENT]	: Enter
[MENU/ESC]	: Cancel
[DISP]	: Exit

3. Select [Source] then press the **ENT** key.

Select	
<b>Internal</b>	: 00:00
<b>NAV EQUIP</b>	
[▲]/[▼]	: Select
[ENT]	: Enter
[MENU/ESC]	: Cancel
[DISP]	: Exit

## 2. NAVIGATION DATA DISPLAY

4. Select [Internal] or [NAV EQUIP] then press the **ENT** key. Select [Internal] to use local time, or [NAV EQUIP] to use UTC time. For [Internal], the [Local Time ADJ] screen appears; go to step 5. For [NAV EQUIP], go to step 6.

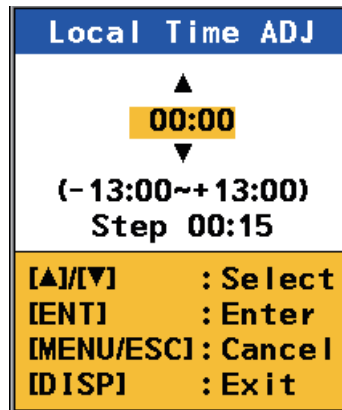

5. Use ▲, ▼ to set the time difference between local time and UTC time then press the **ENT** key.
6. Select [Summer Time] (to turn the daylight savings time indication on or off) then press the **ENT** key.

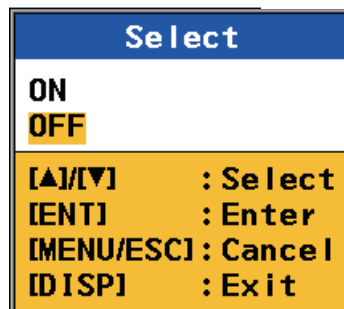

7. Select [ON] or [OFF] then press the **ENT** key.
8. Press the **DISP** key to close the menu.

### 2.2.2 Time format

You can display time in UTC or ship's time (local time).

1. Press the **MENU/ESC** key to open the menu.
2. Select [Scale Set Up] then press the **ENT** key.
3. Select [Mode] then press the **ENT** key.

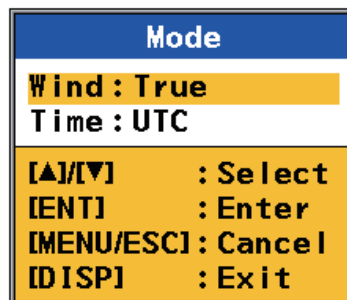

4. Select [Time] then press the **ENT** key.

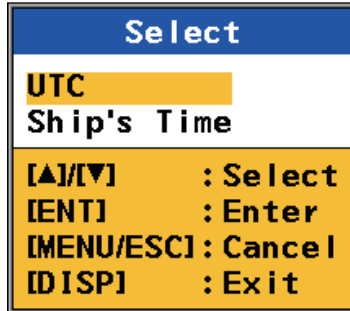

5. Select [UTC] or [Ship's Time] then press the **ENT** key.
6. Press the **DISP** key to close the menu.

### 2.2.3 Depth measurement reference

The depth can be measured from below the keel (fed from external source), or below the transducer. The depth data can be supplied by the transducer of the DS-60 or an external transducer.

1. Press the **MENU/ESC** key to open the menu.
2. Select [Scale Set Up] then press the **ENT** key.
3. Select [Depth REF] then press the **ENT** key.

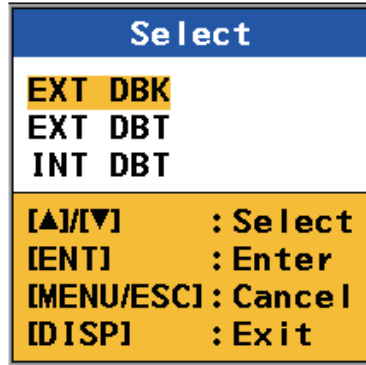

4. Select desired depth measurement reference then press the **ENT** key.  
 [EXT DBK]: Depth Below the Keel, measured by external equipment  
 [EXT DBT]: Depth Below the Transducer, measured by external equipment  
 [INT DBT]: Depth Below the Transducer, measured by the transducer of the DS-60
5. Press the **DISP** key to close the menu.

### 2.2.4 Current direction

The direction of tide currents can be shown as flowing from or flowing to. The current direction indicator (blue triangle marker) is inside the 3-axis speed display for flowing to and outside the display for flowing from. (See the figure on the next page.)

1. Press the **MENU/ESC** key to open the menu.
2. Select [Scale Set Up] then press the **ENT** key.
3. Select [CUR Direction] then press the **ENT** key.

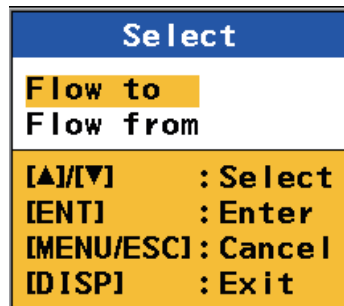

4. Select [Flow to] or [Flow from] then press the **ENT** key.

5. Press the **DISP** key to close the menu.

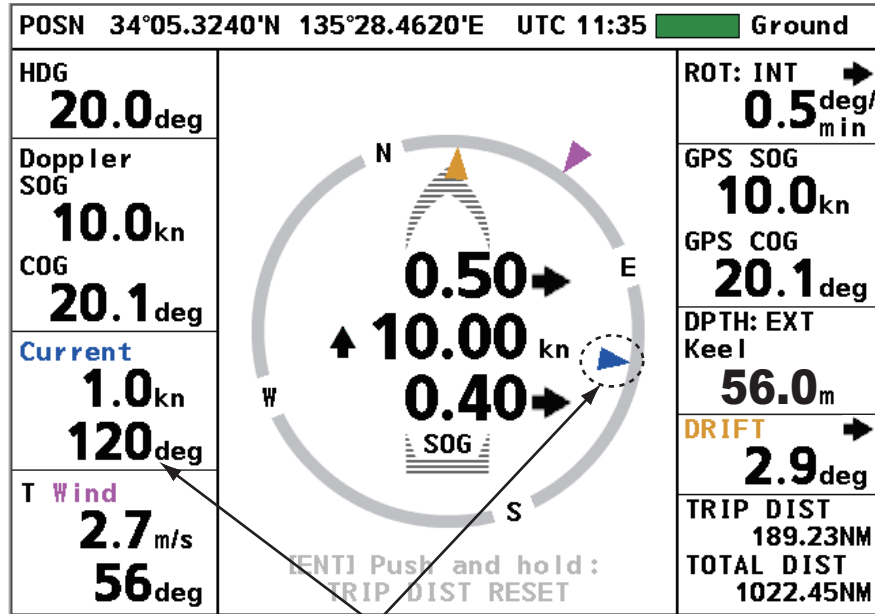

Flow to (example: 120°)

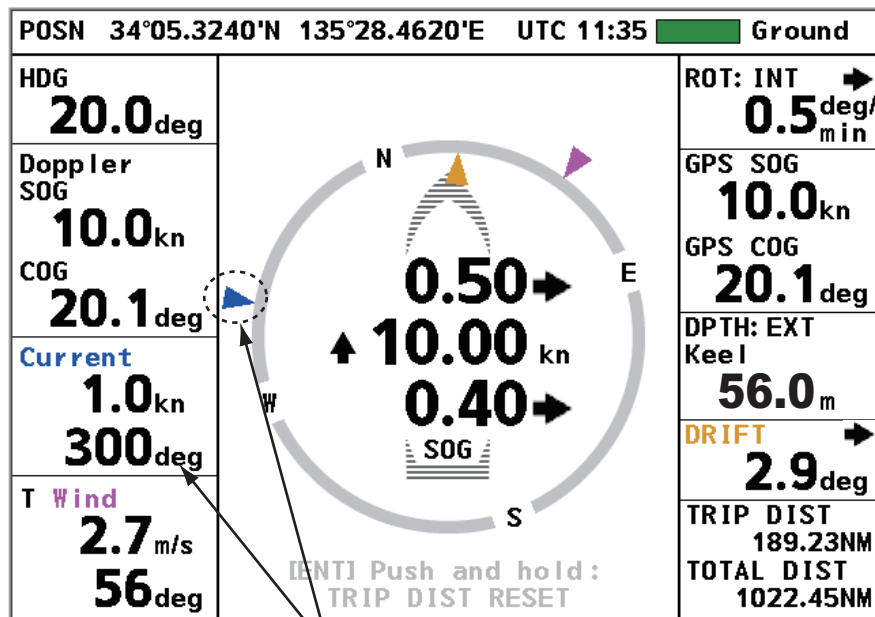

Flow from (example: 300°)

### 2.2.5 Wind angle/direction

The wind angle can be shown as Relative, True or Theoretical. If [OFF] is selected, the wind data is not shown on the screen.

1. Press the **MENU/ESC** key to open the menu.
2. Select [Scale Set Up] then press the **ENT** key.
3. Select [Mode] then press the **ENT** key.

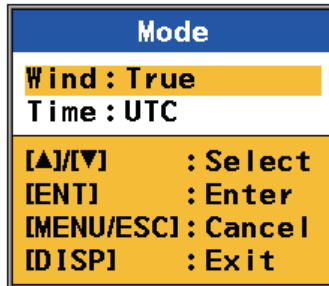

4. Select [Wind] then press the **ENT** key.

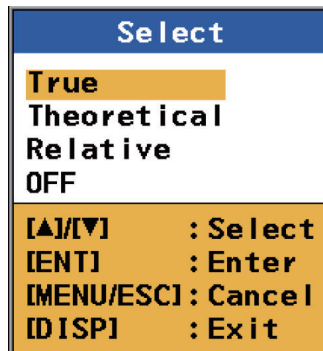

5. Select [True], [Theoretical], [Relative] or [OFF] then press the **ENT** key.
  - [True]: The wind speed and angle minus movement of ship, reference to North.
  - [Theoretical]: The wind speed and angle minus movement of ship, reference to ship's bow.
  - [Relative]: The speed and relative direction that the wind appears to blow with ship in motion, reference to ship's bow.
  - [OFF]: The wind data is not shown on the screen.
6. Press the **DISP** key to close the menu.



## 2.2.6 Wind averaging time

Set the wind averaging time in minutes. Select [No Averaging] for no averaging. The higher the time, the smoother the wind data, but response to the changes in wind speed and angle slows.

1. Press the **MENU/ESC** key to open the menu.
2. Select [Wind Average] then press the **ENT** key.

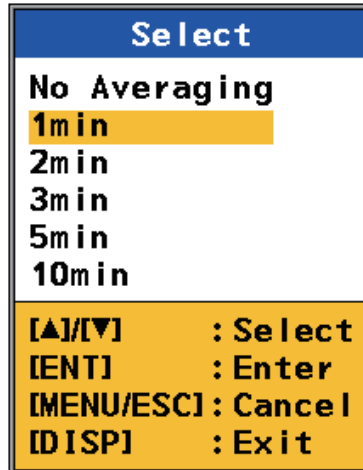

3. Select a value then press the **ENT** key.
4. Press the **DISP** key to close the menu.

## 2.2.7 ROT sensor

Select the ROT sensor as follows:

1. Press the **MENU/ESC** key to open the menu.
2. Select [ROT Sensor] then press the **ENT** key.

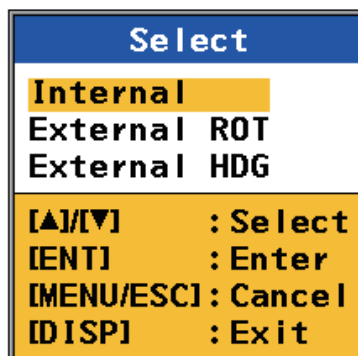

3. Select a source then press the **ENT** key.  
 [Internal]: Select this item if a rate-of-turn-gyro DS-670 (supplied locally) is connected.  
 [External ROT]: Receive ROT data from external sensor.  
 [External HDG]: Calculate ROT data based on the HDG data received from external sensor.
4. Press the **DISP** key to close the menu.

## 2.3 How to Set the Speed Alarm

The speed alarm sets the maximum allowable speed. If the speed of the ship goes higher than the speed set here, the audible alarm sounds and the speed limit alarm icon appears at the right of message area. The alarm sound is stopped after a certain time. The message remains on the screen until you deactivate the alarm, or decrease the speed so that it is lower than the alarm setting.

**Note:** The alarm uses STW always regardless of the current tracking mode. For auto tracking, ground tracking, the SOG shown on the display does not influence for alarm.

1. Press the **MENU/ESC** key to open the menu.
2. Select [Speed Limit Alarm] then press the **ENT** key.

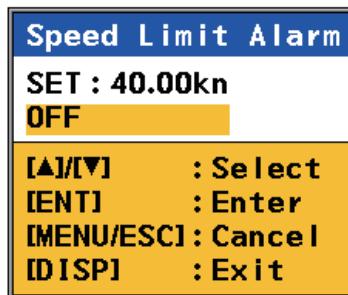

3. Select [SET] then press the **ENT** key.

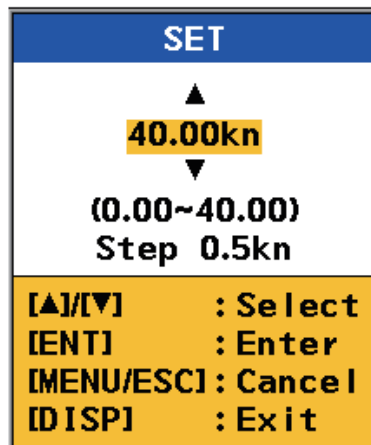

4. Press ▲ or ▼ to set the maximum allowable speed then press the **ENT** key. The setting range is 0.00 to 40.00 kn, in 0.5 kn increments.
5. Press the **DISP** key to close the menu.

To deactivate the alarm, select [OFF] at step 3 then press the **DISP** key.

# 3. BERTHING DISPLAY

## 3.1 Berthing Display Overview

The berthing display shows ship's track (past and/or predicted) and provides help with berthing operations. With position and heading inputs, customizable berthing lines can be shown to help in berthing.

The display orientation is available in Head-up and North-up. Head-up has your heading at the screen top and North-up has North at the top.

The navigation data, which appears at the left side of the display, can be shown or hidden as necessary.

Current (tide) direction and wind angle markers, shown with blue and purple triangle markers respectively, provide quick identification of respective direction or angle.

The 3-axis speed display shows ship's speed in three axes: transverse speed at the reference point, longitudinal speed, and transverse speed at the stern. The display is positioned at the bottom-right corner or top-left corner depending on the location of the own ship marker. You can show or hide the display as required.

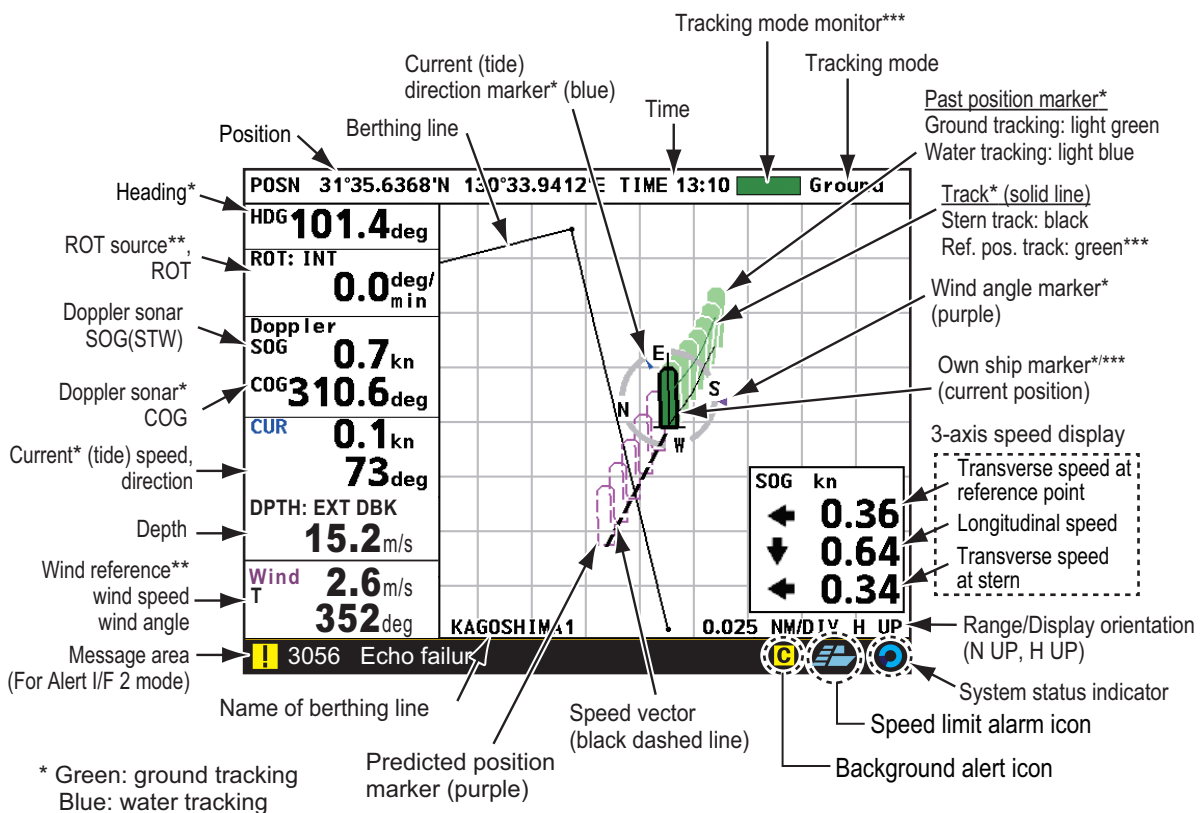

\*: Requires heading data. If there is no heading data, "--" appears and the ▲ mark and "NSEW" (indicates the azimuth) are not shown.

\*\* : ROT: Heading data is required only for [EXT HDG].

WIND: Heading data is required only for [True].

\*\*\*: Ground tracking: Green Water tracking: Blue

### 3. BERTHING DISPLAY

#### Own ship marker

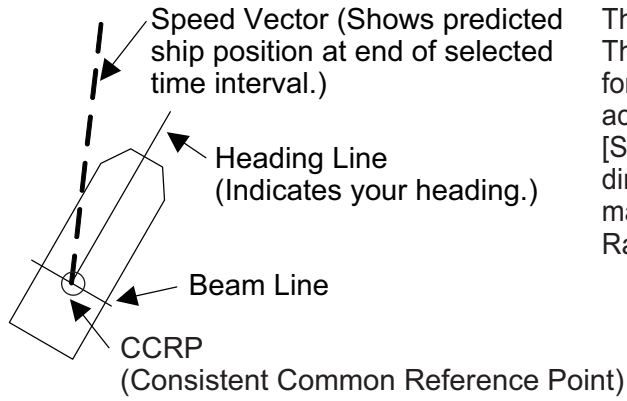

The own ship marker indicates current position. The marker is green for ground tracking and blue for water tracking. The marker is scaled according to ship length and width, set on the [Setting Ship Data] menu. If the range and dimensions of the ship are as shown below, the marker is shown with concentric circles.  
 $\text{Range} \times 8 \geq \text{Ship's length} \times 30, \text{ or } \text{Width} \times 52$

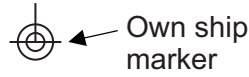

## 3.2 Display Range

### 3.2.1 How to select a range

The display range is the distance between grid sides on the berthing display. Use the **RNG** key to select a range. The range appears below the 3-axis speed display as shown below. The system is pre-set with five ranges (nm): 0.025, 0.04, 0.05, 0.075 and 0.1. A total of 11 ranges are available and you can select the ranges to use from the menu, as shown in the next section.

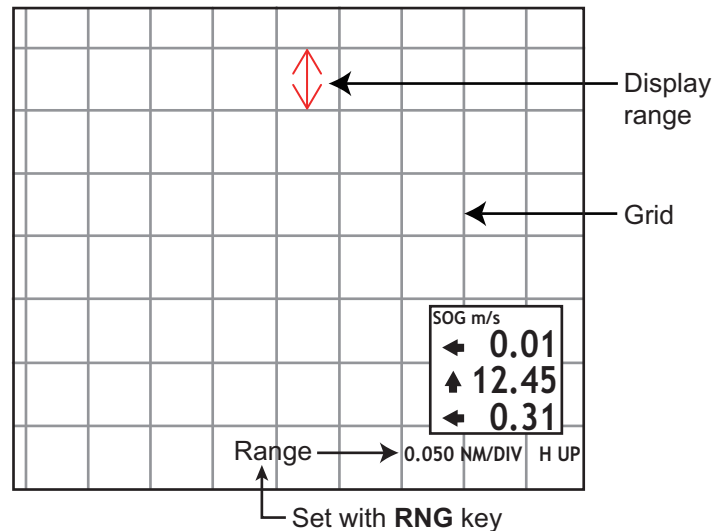

### 3.2.2 How to pre-set ranges

The berthing display has a total of 11 ranges. Select the ranges to use, following the procedure shown below. A minimum of one range must be turned on.

1. Press the **MENU/ESC** key to open the menu.
2. Select [Set Up Scale] then press the **ENT** key.
3. Select [Range] then press the **ENT** key.
4. Select a range then press the **ENT** key. Show "X" in a check box to select the range, or remove the "X" to deselect the range.
5. Press **▼** to show and select [Save] then press the **ENT** key.  
**Note:** If all ranges are turned off, the message "No item be selected" appears. Select at least one range.
6. Press the **DISP** key to close the menu.

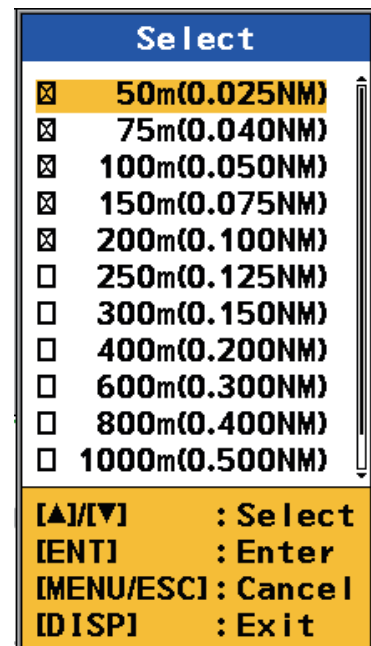

### 3.3 Track

The DS-60 uses speed data to plot your ship's track on the display. You can show past track or predicted track, or both past and predicted tracks.

#### 3.3.1 Types of tracks

Two types of track are available: past and predicted.

##### Past track

Past track can be shown with past ship markers or both solid lines and past ship markers.

There are two types of past track: reference position track and stern track. The reference position track is green (ground tracking) or blue (water tracking), and the stern track is black. The tracks of the past five minutes are shown.

A past track marker is added every 30 seconds. The markers are colored light blue for water tracking, and light green for ground tracking. The last five minutes of past track markers are shown

You can select the type of past track to show from the menu. See section 3.3.3 for the procedure.

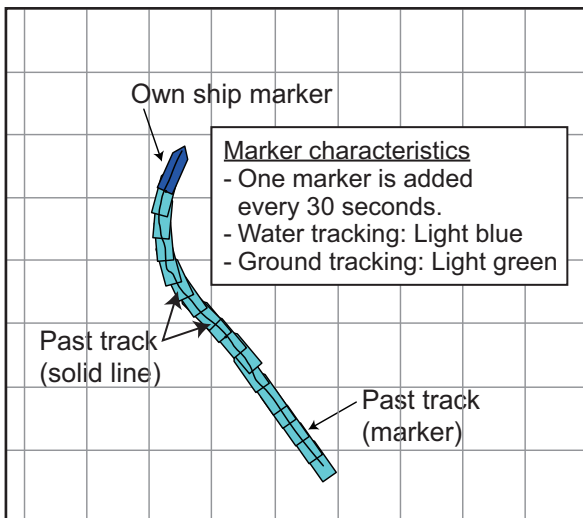

Past track (marker and solid line)

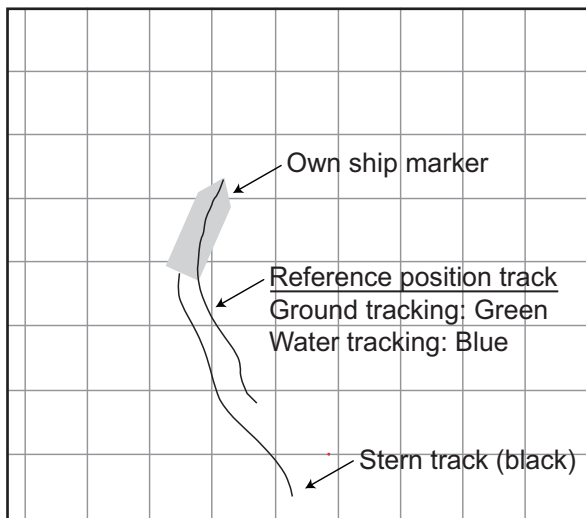

Past track (solid line)

### Predicted track

The predicted track feature shows estimated position of your ship at the end of the selected time interval. (See section 3.3.4 for the procedure.) The estimated position is calculated from the reference point and stern speeds taken from the ground and water tracking speed data. The marker is purple, hollow and dashed to distinguish it from the own ship marker and the past track markers.

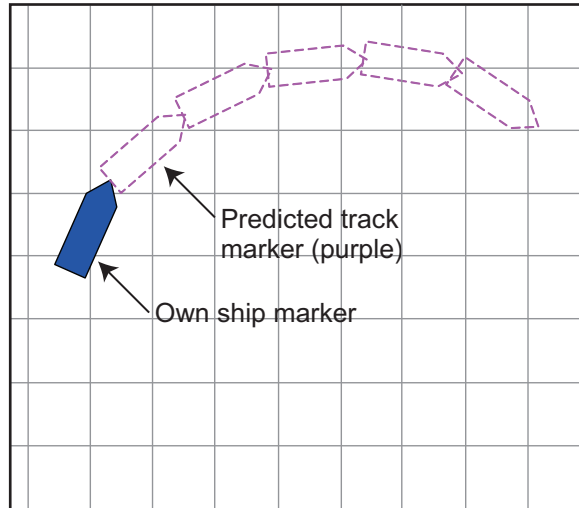

Predicted track

### 3.3.2 How to select the type of track to display

1. Press the **MENU/ESC** key to open the menu.
2. Select [Ship's Track] then press the **ENT** key.

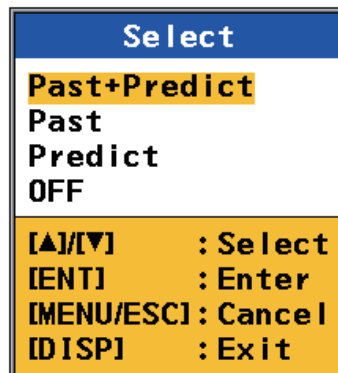

3. Select the type of track to display then press the **ENT** key. Select [OFF] to hide all tracks.
4. Press the **DISP** key to close the menu.

### 3.3.3 How to select the past track format

The past track can be shown with a solid line or solid line and past track markers. See the illustration on page 3-3.

1. Press the **MENU/ESC** key to open the menu.
2. Select [Past Tracks] then press the **ENT** key.

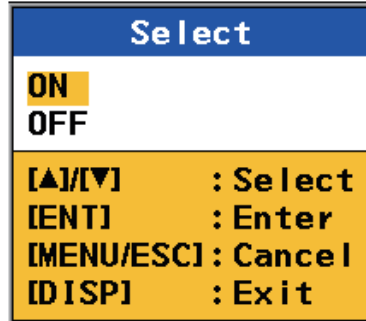

3. Select [ON] or [OFF] then press the **ENT** key.  
 [ON]: Past track marker + solid line  
 [OFF]: Past track marker only
4. Press the **DISP** key to close the menu.

### 3.3.4 How to select the predicted track plot interval

Select the interval at which to plot the predicted track as follows:

1. Press the **MENU/ESC** key to open the menu.
2. Select [Plot Time] then press the **ENT** key.

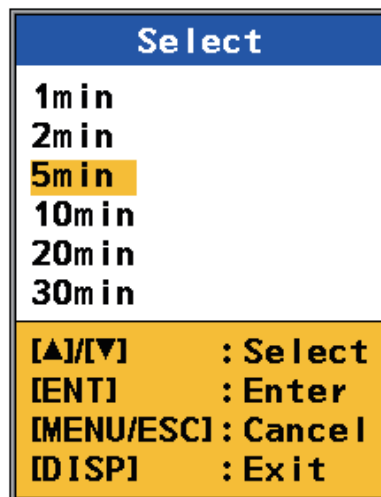

3. Select a time then press the **ENT** key. A new marker is plotted at equally time-spaced intervals of 1/5 of the plot time selected. For example, if you select the 10-minute interval, the predicted position is plotted at two-minute intervals.
4. Press the **DISP** key to close the menu.



## 3.4 How to Select Vector Time

The tip of the vector line on the own ship marker shows the estimated position of your ship after the selected vector time elapses, using the current course and speed. You can adjust the length of the vector line to see estimated position at the end of the prescribed time interval.

1. Press the **MENU/ESC** key to open the menu.
2. Select [Vector Time] then press the **ENT** key.

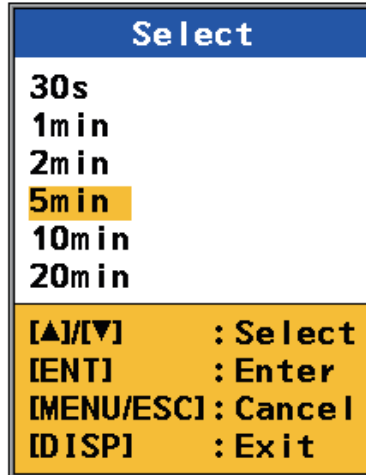

3. Select a vector time then press the **ENT** key. The longer the time, the longer the vector line.
4. Press the **DISP** key to close the menu.

### 3.5 How to Show, Hide Navigation Data and 3-axis Speed Data

The berthing display can show NAV data and 3-axis speed data. You can show them in separate windows, show the 3-axis speed data in the NAV data window, or show only the 3-axis speed data (no NAV data). Long-push the **ENT** key to show or hide the data, in the sequence shown below. The data can also be shown or hidden with [Data Display] in the [Scale Set Up] menu.

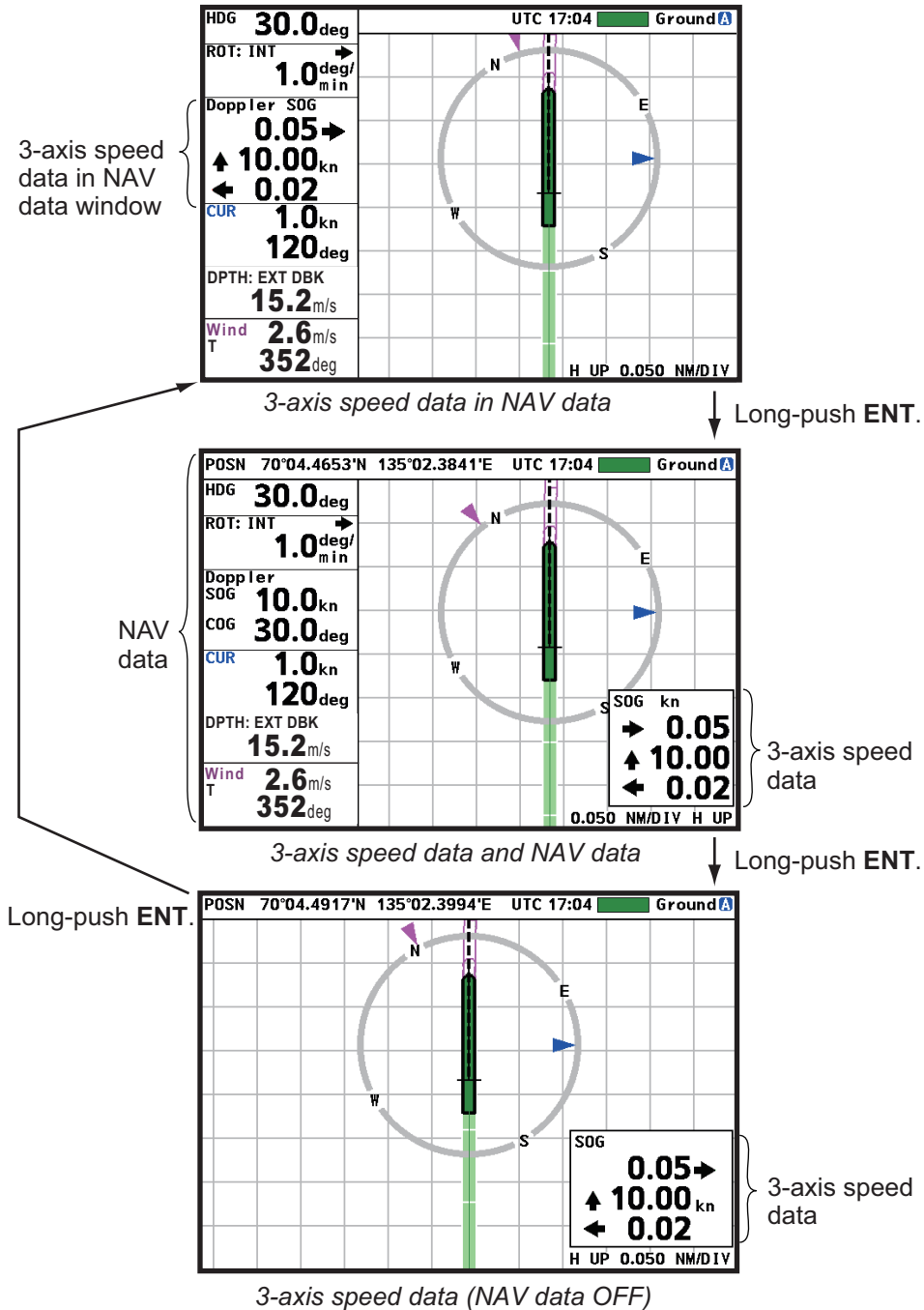

## 3.6 Berthing Line

A berthing line that represents an intended berth can be shown to help in berthing operations. The DS-60 stores a maximum of 100 berthing lines, and a berthing line can have a maximum of three points. All berthing lines within the current display range are automatically shown. A berthing line is automatically sent to all powered sub display units the moment the line is saved.

### 3.6.1 How to create a berthing line

Berthing lines can only be created from the main display unit.

1. Press the **MENU/ESC** key to open the menu.
2. Select [Berthing Line] then press the **ENT** key.

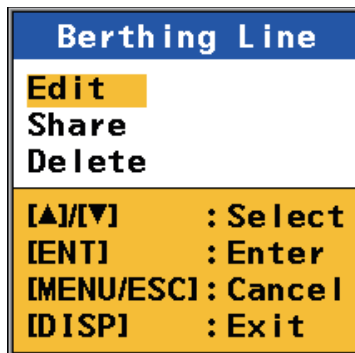

3. Select [Edit] then press the **ENT** key.

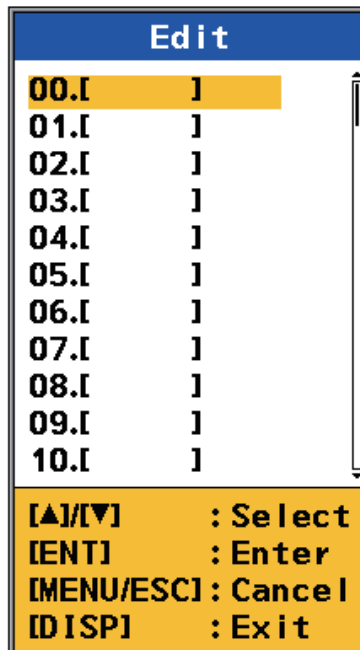

### 3. BERTHING DISPLAY

4. Select an empty number then press the **ENT** key.

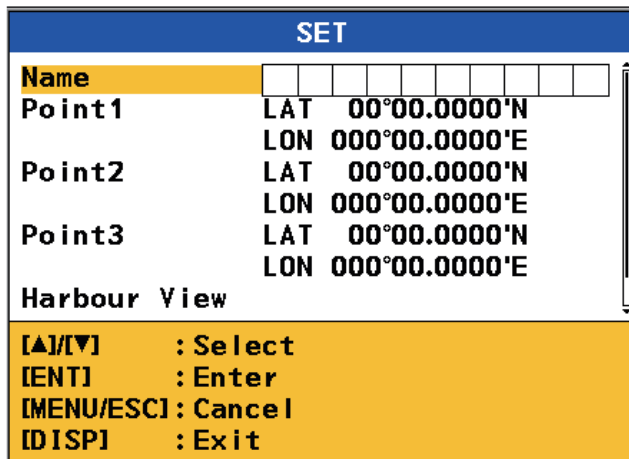

5. [Name] is selected; press the **ENT** key.

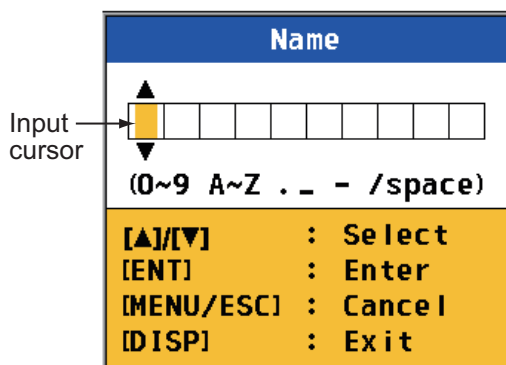

6. Enter a name for the berthing line. For example, the name of the harbor related to the berthing line.
  - 1) The input cursor is at the far-left position. Press ▲ or ▼ to select a character then press the **ENT** key. The input cursor moves to the next input point.
  - 2) Repeat step 1) to complete the name. To move the input cursor, use the **ENT** key to move it right, the **MENU/ESC** key to move it left.

**Note:** If you do not enter a name, the message "Please enter name." appears. Enter a name.

7. Press the **ENT** key to go to the [SET] menu.
8. Press ▼ to select the [LAT] line of [Point1] then press the **ENT** key.

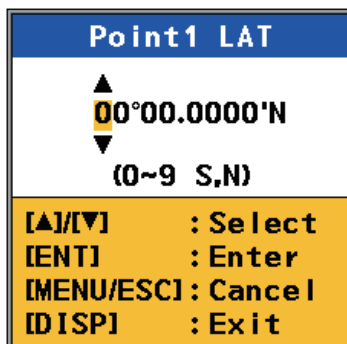

9. Use ▲ or ▼ to select the first digit of the latitude position then press the **ENT** key. Enter the remaining digits in the same method. (Use the **ENT** key to move the cursor right, and the **MENU/ESC** key to move the cursor left.)

10. Select the [LON] line of [Point1] then press the **ENT** key.

Point1 LON	
▲ 000°00.0000'E ▼	
(0~9 E,W)	
[▲]/[▼]	: Select
[ENT]	: Enter
[MENU/ESC]	: Cancel
[DISP]	: Exit

11. Enter the longitude, same as how you entered the latitude.

12. Enter the points 2 and 3.

13. Select [Harbour View] then press the **ENT** key. The display shows

- Berthing line
- Name of berthing line, and
- Latitude and longitude position of each point.

**Note:** If the distance between two consecutive points is more than one degree, the message "Points too far, maximum distance between points is 1 degree" appears. Reenter point(s).

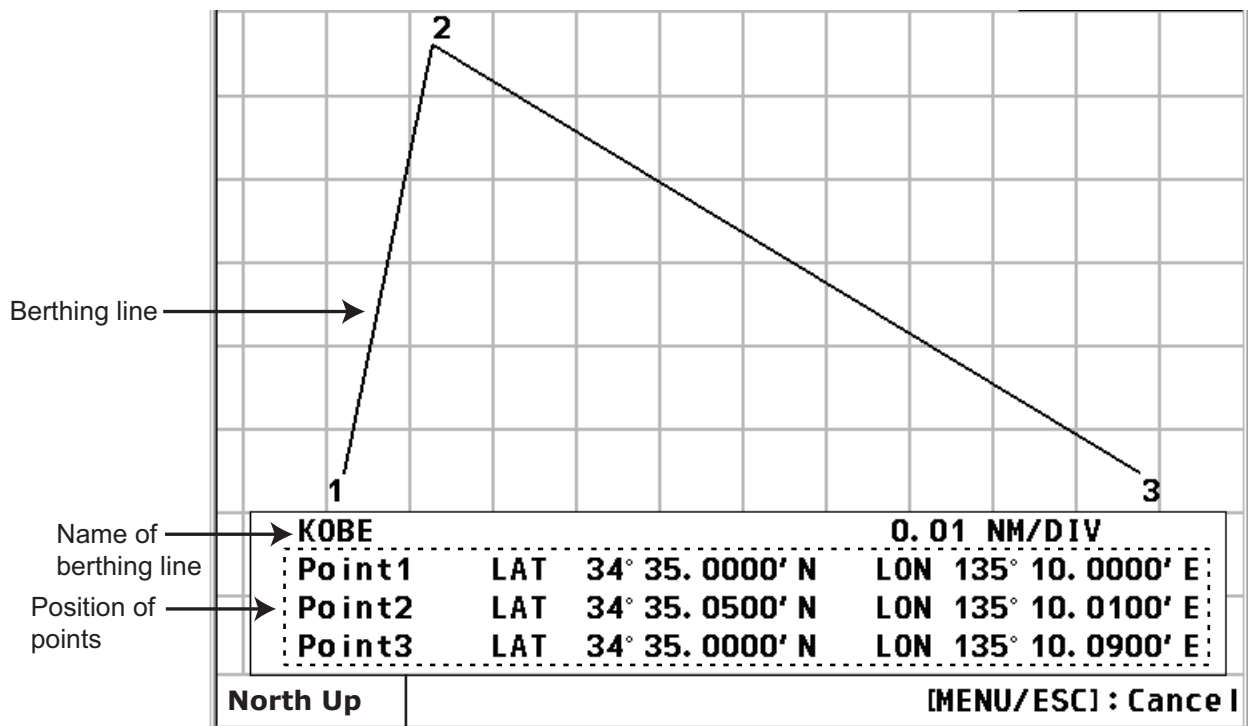

### 3. BERTHING DISPLAY

14. To save the line, press the **MENU/ESC** key to return to the [SET] dialog box (see the figure at the top of page 3-10). Press ▼ to show and select [Exit] then press the **ENT** key. (The berthing line is sent to all active sub display units when the **ENT** key is pressed.)

Edit	
<b>00.KOBE</b>	
<b>01.I</b>	<b>]</b>
<b>02.I</b>	<b>]</b>
<b>03.I</b>	<b>]</b>
<b>04.I</b>	<b>]</b>
<b>05.I</b>	<b>]</b>
<b>06.I</b>	<b>]</b>
<b>07.I</b>	<b>]</b>
<b>08.I</b>	<b>]</b>
<b>09.I</b>	<b>]</b>
<b>10.I</b>	<b>]</b>
<b>[▲]/[▼]</b>	<b>: Select</b>
<b>[ENT]</b>	<b>: Enter</b>
<b>[MENU/ESC]</b>	<b>: Cancel</b>
<b>[DISP]</b>	<b>: Exit</b>

**Note:** If you select [Harbour View] without entering a name, the message "Harbour Name/Berthing Line plans must be named individually, please enter name." appears. Enter a name.

15. To make another berthing line, repeat steps 4-14. To finish, press the **DISP** key.

**Note:** You can edit berthing lines. Open the [Berthing Line] menu, select [Edit] then select a berthing line. The remaining procedure is similar to how you enter a berthing line.

### 3.6.2 How to share berthing lines with sub display units

Berthing lines created at the main display unit are automatically sent to all sub display units that are active when the line is created. To send the berthing lines after a sub display unit becomes active, do as follows:

1. Press the **MENU/ESC** key to open the menu.
2. Select [Berthing Line] then press the **ENT** key.

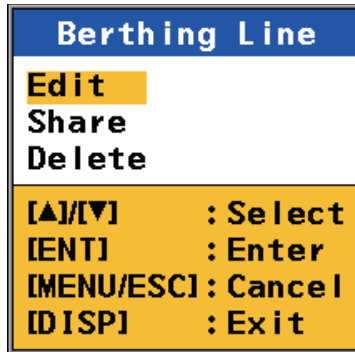

3. Select [Share] then press the **ENT** key.

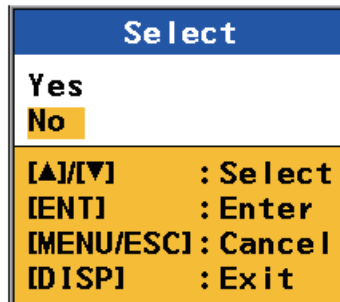

4. Select [Yes] then press the **ENT** key. All berthing lines in the sub display units are replaced with the berthing lines from the main display unit.
5. Press the **DISP** key to close the menu.

### 3.6.3 How to delete a berthing line

If you do not need a berthing line that you have made, you can delete the line as shown below. The line is deleted from both the main and sub display units.

1. Press the **MENU/ESC** key to open the menu.
2. Select [Berthing Line] then press the **ENT** key.

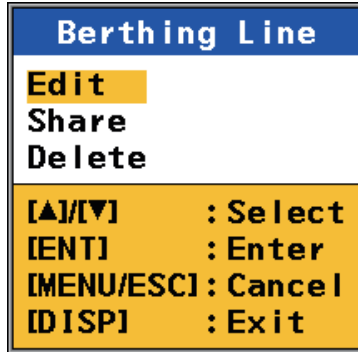

3. Select [Delete] then press the **ENT** key to show the list of berthing lines.

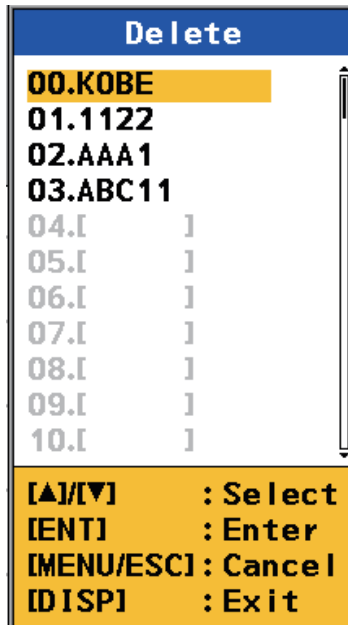

4. Select the line to delete then press the **ENT** key. You are asked if you are sure to delete the line.

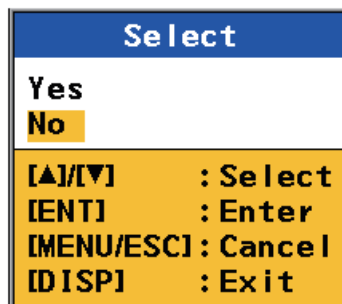

5. Select [Yes] then press the **ENT** key.
6. Press the **DISP** key to close the menu.



# 4. SPEED GRAPHIC DISPLAY

The speed graphic display, available with the sub display unit, provides absolute speed or ahead and astern speeds, in a speedometer arrangement.

## 4.1 Speed Graphic Indications

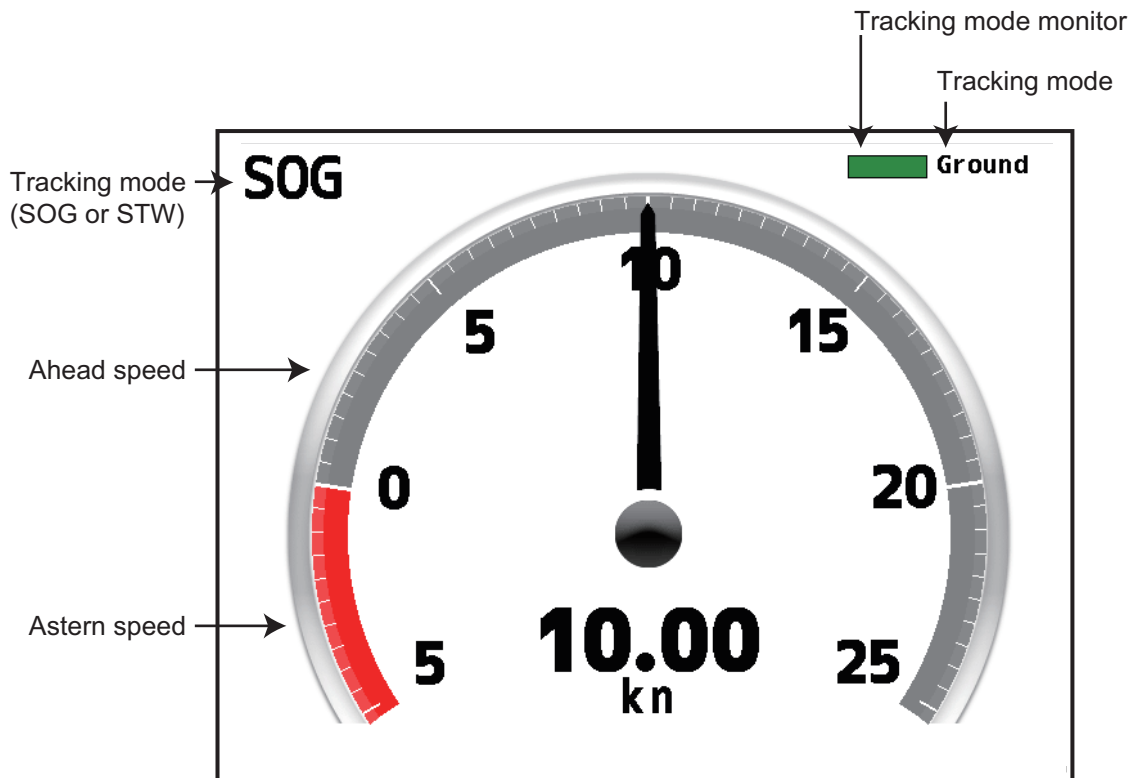

## 4.2 How to Set the Speed Graphic

Select the display number where to show the speed graphic and the scale for the astern speed and ahead speed indications. The total display range for the two indications is 70 knots, and you can divide that total as required.

1. Press the **MENU/ESC** key to open the menu.
2. Select [Scale Set Up] then press the **ENT** key.

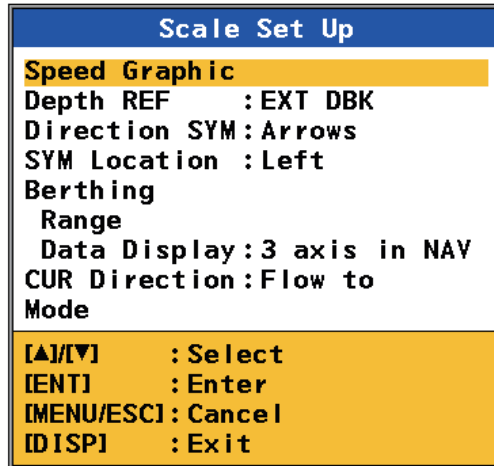

3. Select [Speed Graphic] then press the **ENT** key.

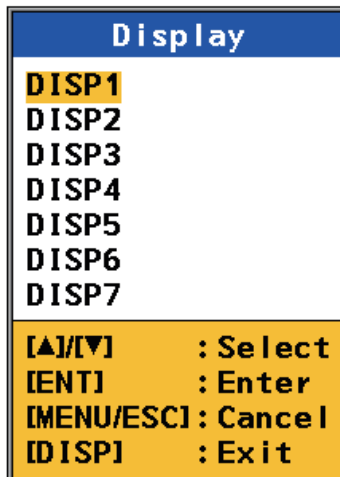

4. Select the display number (default display number for the graphic display is DISP5) where to show the speed graphic display then press the **ENT** key.

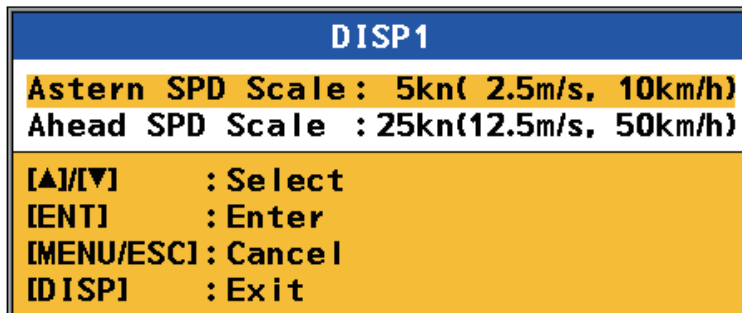

- The cursor is selecting [Astern SPD Scale]; press the **ENT** key.

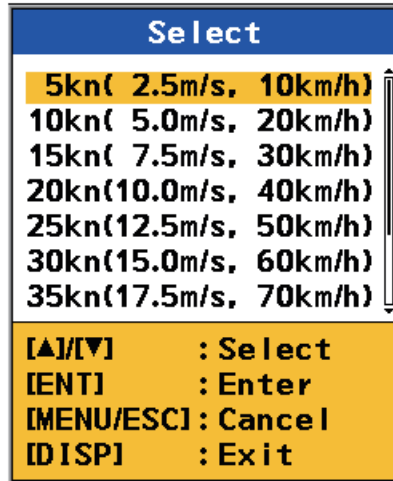

- Select the scale range for the astern speed then press the **ENT** key.
- Select [Ahead SPD Scale] then press the **ENT** key.
- Select the scale range for the ahead speed then press the **ENT** key.
- Press the **DISP** key to close the menu.

### 4.3 How to Select the Display Format for the Speed Graphic

The speed graphic can show absolute speed or ahead and astern speeds. Absolute speed is shown in three digits and ahead and astern speeds in four digits.

- Press the **MENU/ESC** key to open the menu.
- Select [Speed Select] then press the **ENT** key.

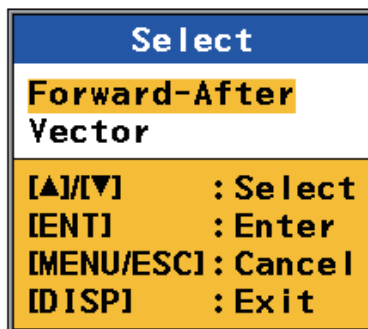

#### 4. SPEED GRAPHIC DISPLAY

3. Select [Forward-After] or [Vector] then press the **ENT** key. See the illustration below.

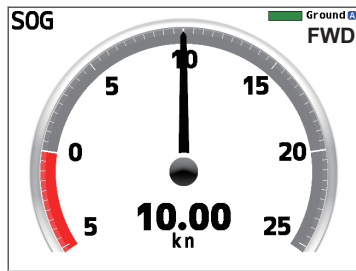

“Forward-After” setting  
(Four-digit speed indication)

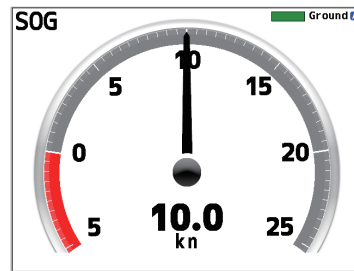

“Vector” setting  
(Three-digit speed indication)  
No text or arrows shown.

When Direction SYM is set to “Text”, “FWD” or “AFT” is shown. FWD or AFT not shown when “Arrows” is selected.

#### *Speedometer display*

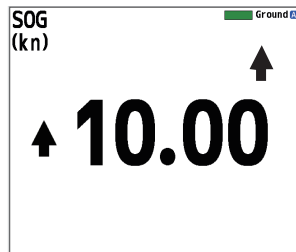

“Forward-After” setting  
(Four-digit speed indication)



“Vector” setting  
(Three-digit speed indication)  
No text or arrows shown.

When Direction SYM is set to “Text”, “FWD” or “AFT” is shown. Arrows shown when “Arrows” is selected.

#### *1-axis speed display*

4. Press the **DISP** key to close menu.

## 4.4 How to Change the Speed Graphic Format

The default speed graphic has the zero point for the ahead and astern speedometers on the left side of the display, and the pointer moves rightward with increase in ahead speed. If desired, you can reverse that arrangement.

This setting also changes the position of the direction indicators on the digital speed displays. See section 5.5.

1. Press the **MENU/ESC** key to open the menu.
2. Select [Scale Set Up] then press the **ENT** key.
3. Select [SYM Location] then press the **ENT** key.

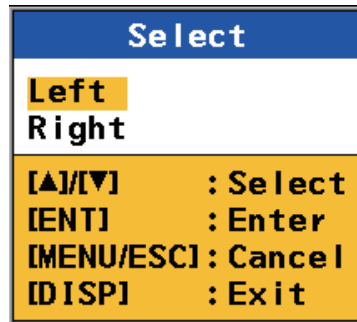

4. Select [Left] or [Right] then press the **ENT** key.  
 [Left]: The pointer moves rightward with increase in ahead speed, and the zero point for the speedometers is on the left.  
 [Right]: The pointer moves leftward with increase in ahead speed, and the zero point for the speedometers is on the right.

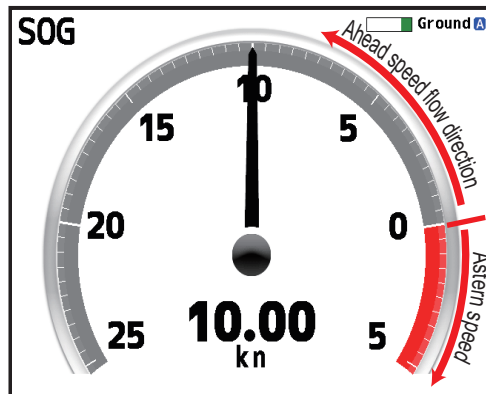
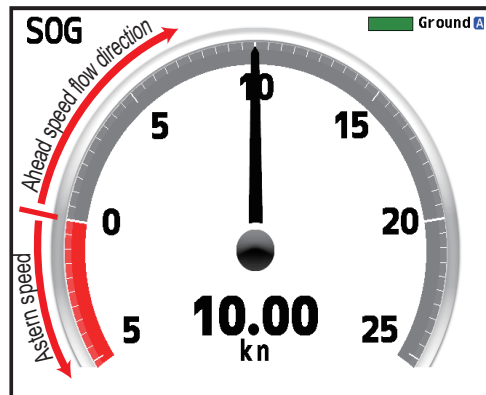

5. Press the **DISP** key to close the menu.

#### 4. SPEED GRAPHIC DISPLAY

This page is intentionally left blank.

# 5. OTHER OPERATIONS

This chapter provides the descriptions for the menu items not described in other chapters.

## 5.1 How to Set the Displays

The DS-60 is pre-set with four displays and you can set a maximum of seven displays. There are two types of screen arrangements: full screen and two-way horizontal split screen. A full-screen display can show a graphic display (navigation data, berthing, speed graphic (sub display unit only)), or digital data (trip distance, heading, etc.). A two-way horizontal split screen can show two digital data.

1. Press the **MENU/ESC** key to open the menu.
2. Select [Display] then press the **ENT** key.

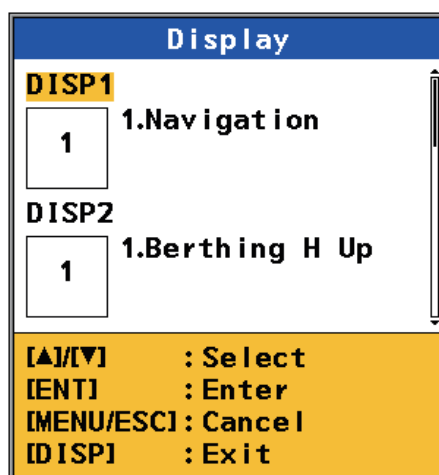

3. Select a display number ([DISP1] - [DISP7]) then press the **ENT** key.

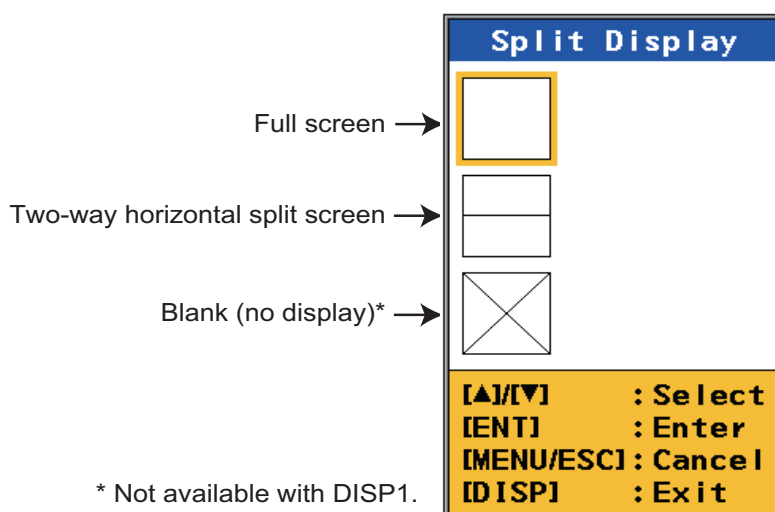

5. OTHER OPERATIONS

- Select the full screen, two-way horizontal split or blank icon (no display) then press the **ENT** key. The display now shows the selections available for the type of screen you selected.

Item	
	HDG/Speed 3 axis
	Speed 3 axis
	Speed 2 axis
	Speed 1 axis
1	Speed Graphic
	<b>Navigation</b>
	Berthing H Up
	Berthing N Up
	Trip DIST
	Total DIST
<b>[▲]/[▼] : Select</b> <b>[ENT] : Enter</b> <b>[MENU/ESC] : Cancel</b> <b>[DISP] : Exit</b>	

Options available with full screen

Item	
	Speed 1 axis
1	<b>Trip DIST</b>
	Total DIST
	HDG
	ROT
<b>[▲]/[▼] : Select</b> <b>[ENT] : Enter</b> <b>[MENU/ESC] : Cancel</b> <b>[DISP] : Exit</b>	

Options available with two-way horizontal split screen

*Grayed item not available for selection.*

- Select a data item then press the **ENT** key. See the illustration on the next page for the appearance of the displays.

**For the two-way horizontal split screen**, the screen shown below appears after you select the data to show in the top half of the screen. Select a data item for the bottom half of the screen then press the **ENT** key.

Item	
	Speed 1 axis
	<b>Trip DIST</b>
	Total DIST
2	HDG
	ROT
<b>[▲]/[▼] : Select</b> <b>[ENT] : Enter</b> <b>[MENU/ESC] : Cancel</b> <b>[DISP] : Exit</b>	

← Grayed item not available for selection.

- Press the **DISP** key to close the menu.



Full-screen displays

<p>Navigation data</p>	<p>Berthing (Head-up)</p>	<p>Berthing (North-up)</p>	<p>Trip distance</p>
<p>Total distance</p>	<p>Heading and 3-axis speed</p>	<p>3-axis speed</p>	<p>2-axis speed</p>
<p>1-axis speed (sub display unit only)</p>	<p>Speed graphic (sub display unit only)</p>	<p>2-axis speed/distance</p>	

Horizontal split displays

<p>Trip distance, ROT</p>	<p>Total distance, heading</p>	<p>Heading, ROT</p>	<p>Trip distance, total distance</p>
---------------------------	--------------------------------	---------------------	--------------------------------------

## 5.2 Key Beep On/Off

A key beeps when it is pressed. You can turn this beep on or off.

1. Press the **MENU/ESC** key to open the menu.
2. Select [Key Beep] then press the **ENT** key.

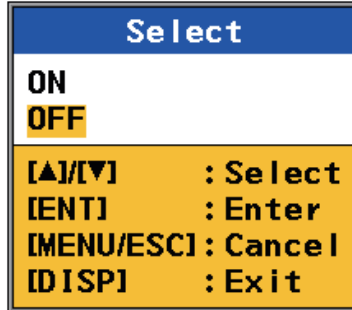

3. Select [ON] or [OFF] then press the **ENT** key.
4. Press the **DISP** key to close the menu.

## 5.3 How to Adjust Key Dimmer

You can adjust the dimmer for the keys as follows:

1. Press the **MENU/ESC** key to open the menu.
2. Select [Key BRILL] then press the **ENT** key.

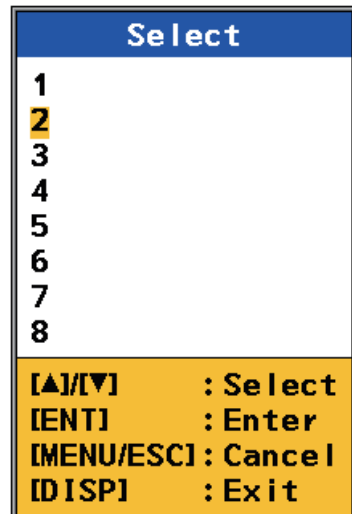

3. Select a dimmer level then press the **ENT** key. The higher the figure, the higher the dimmer level.
4. Press the **DISP** key to close the menu.



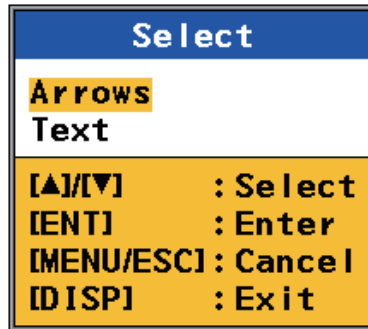

## 5.4 How to Select Direction Symbol Format

The direction symbols for speed and ROT can be shown with arrows or text.

1. Press the **MENU/ESC** key to open the menu.
2. Select [Scale Set Up] then press the **ENT** key.
3. Select [Direction SYM] then press the **ENT** key.



4. Select [Arrows] or [Text] then press the **ENT** key.

Arrows	Text
	STBD, S*
	PORT, P*
	FWD
	AFT

\* Navigation data display, berthing display

5. Press the **DISP** key to close the menu.

## 5.5 How to Select the Location for the Direction Symbols

The direction symbols (arrows) for the transverse speeds (reference point, stern) can be displayed on the left or right side of those indications on the digital speed displays. (The ship's speed direction indicator (↑) is on the left always.) This setting does not affect the 3-axis speed display in the navigation data display or berthing display.

This setting also changes the format for the speed graphic. See section 4.4.

1. Press the **MENU/ESC** key to open the menu.
2. Select [Scale Set Up] then press the **ENT** key.
3. Select [SYM Location] then press the **ENT** key.

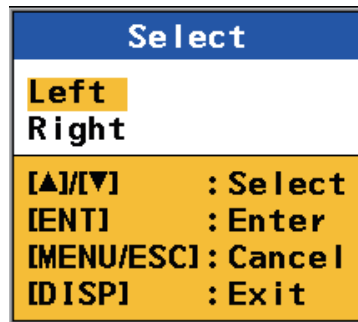

4. Select [Left] or [Right] then press the **ENT** key.  
 [Left]: The direction indicators are on the right side of the speed indications.  
 [Right]: The direction indicators are on the left side of the speed indications.

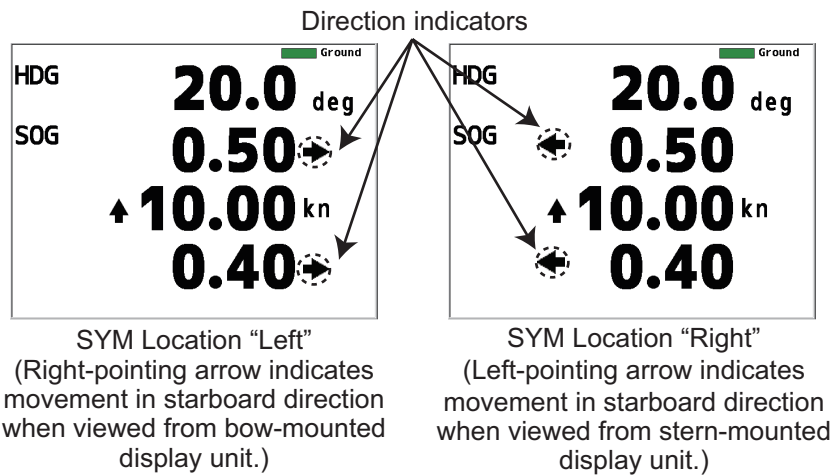

*Direction symbols in heading and speed display*

5. Press the **DISP** key to close the menu.

## 5.6 Total Distance Run

### 5.6.1 How to reset total distance run

1. Press the **MENU/ESC** key to open the menu.
2. Select [Total DIST] then press the **ENT** key.

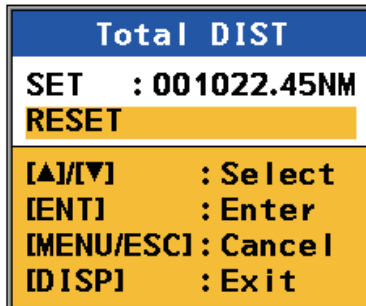

3. [RESET] is selected; press the **ENT** key. You are asked if you are sure to reset the total distance run.

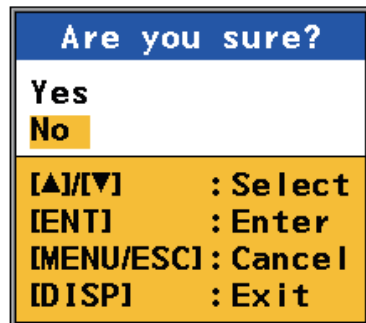

4. Select [Yes] then press the **ENT** key.
5. Press the **DISP** key to close the menu.

### 5.6.2 How to set total distance run

The total distance run figure can be adjusted as required.

1. Press the **MENU/ESC** key to open the menu.
2. Select [Total DIST] then press the **ENT** key.

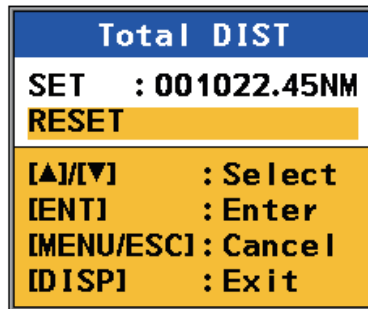

3. Select [SET] then press the **ENT** key.

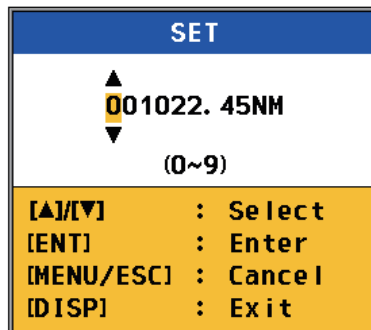

4. Use ▲ or ▼ to set a value then press the **ENT** key. (You can move the cursor to the right with the **ENT** key. Use the **MENU/ESC** key to move the cursor to the left.)
5. Repeat step 4 as required.
6. Press the **DISP** key to close the menu.

## 5.7 System Parameters

The [System Parameters] menu provides the functions that once set do not require regular adjustment.

1. Press the **MENU/ESC** key to open the menu.
2. Select [System] then press the **ENT** key.

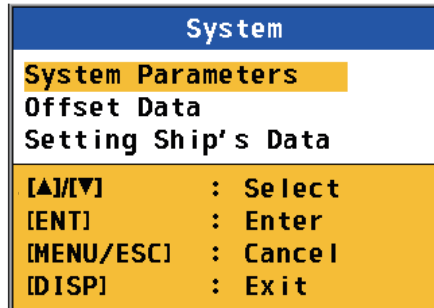

3. Select [System Parameters] then press the **ENT** key.

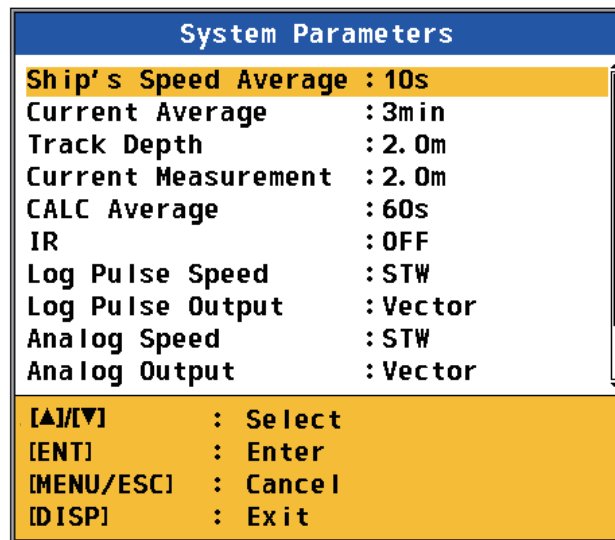

5. OTHER OPERATIONS

**System parameters menu description**

Item	Description	Available settings
Ship's Speed Average	Set averaging time for ship's speed. The default setting is acceptable for most conditions. If the speed indication is unstable, select the setting that gives stable speed data.	5s, 10s, 15s, 30s, 60s
Current Average	Set averaging time for current (tide) speed and direction. The default setting is acceptable for most conditions. If the current data changes randomly, select the setting that gives stable current data, but does not slow response to changes in current data.	1min, 2min, 3min, 5min, 10min
Track Depth	Set the water tracking depth for measurement of through-the-water-speed. If the through-the-water speed readout is unstable, raise the setting.	0.5 - 25.0(m), 0.1m steps
Current Measurement	Set the depth at which to measure current (tide) speed and direction.	0.5 - 25.0(m), 0.1m steps
CALC Average	Smooth the heading data, which is received every second.	No Averaging, 10s, 30s, 60s, 90s, 120s
IR	Turn the interference rejector on or off. Turn the rejector on when an echo sounder is connected to the DS-60, to prevent mutual interference.	ON, OFF
Log Pulse Speed	Select the data to use to calculate distance run.	STW&GPS; SOG&STW&GPS; SOG&GPS; STW
Log Pulse Output	Select the log pulse speed to output to external equipment. <ul style="list-style-type: none"> <li>• Forward: Forward speed only</li> <li>• Forward-After: Forward and after speeds</li> <li>• Vector: Synthesized speed consisting of forward, after, port and starboard speeds</li> </ul>	Forward; Forward-After; Vector
Analog Speed	Select the source for the analog speed indication.	STW&GPS; SOG&STW&GPS; SOG&GPS; STW
Analog Output	Select the analog speed to output to external equipment. <ul style="list-style-type: none"> <li>• Forward: Forward speed only</li> <li>• Forward-After: Forward and after speeds</li> <li>• Vector: Synthesized speed consisting of forward, after, port and starboard speeds</li> </ul>	Forward; Forward-After; Vector
Beam Direction	Select the beam directions to use to measure speed. Forward: 0°, 120°, 240° After: 60°, 180°, 300°	Forward, After
TVG Curve	Used for internal calculations, and the default setting is zero. Do not change the setting. Contact a FURUNO agent or dealer for information.	0 -19
ECHO FAIL Limit	Set the gain threshold for [ECHO FAIL] judgement. (For the serviceman.)	0 - 9



# 6. MAINTENANCE

This chapter provides the maintenance and troubleshooting information for the operator. If you cannot restore normal operation, do not try to check inside the equipment. Refer any repair work to a qualified technician.

WARNING

**ELECTRICAL SHOCK HAZARD**  
Do not open the equipment.

This equipment uses high voltage that can cause electrical shock.  
Only qualified persons can work inside the equipment.

NOTICE

**Do not apply paint, anti-corrosive sealant or contact spray to plastic parts or equipment coating.**

Those items contain products that can damage plastic parts and equipment coating.

## 6.1 Maintenance



Periodic maintenance is important to keep good performance. Check the system at regular intervals with the procedures shown in the table below.

Item	Check point	Action
Cables	Check that all cables are tightly fastened. Check the cables for corrosion and rust.	Connect loosened cables. Replace any damaged cables.
Cabinet	Dust on the cabinets	Remove dust with a dry, clean cloth. Do not use commercial cleaners to clean any part of the equipment. Commercial cleaners can remove paint and markings.
LCD (display unit)	Dust on the LCD	Wipe the LCD carefully to prevent scratching, using tissue paper and an LCD cleaner. To remove dirt or salt deposits, use an LCD cleaner, wiping slowly with tissue paper so as to dissolve the dirt or salt. Change paper frequently so the salt or dirt will not scratch the LCD. Do not use commercial cleaners to clean any part of the equipment. Commercial cleaners can remove paint and markings.
Transducer	Marine life and growth on the transducer	Marine life (barnacles, etc.) adhering to the transducer face can reduce sensitivity. Periodically re-move any marine life from the transducer face with fine sandpaper or a piece of wood. Do no paint the transducer face. Performance will be affected.
Fixing bolts, nuts and cable clamp area (outdoor units only)	Adhesive TB5211 (marine sealant), etc.	Also check the anti-corrosive sealant on the ground bolt for deterioration (peeling, cracking, etc.) every 3 to 6 months. If the deterioration is minor, re-apply the adhesive TB5211 (marine sealant) etc. For serious deterioration, completely remove the adhesive TB5211 (marine sealant), etc, then re-apply the adhesive TB5211 (marine sealant), etc. Water leakage can corrode the bolt if it is not properly treated.

## 6.2 Consumable Parts

### 6.2.1 Fuse replacement

The fuse in the Display Unit, Transceiver Unit, Distributor Unit and Rate-of-Turn Gyro protects those units from over-voltage. If you cannot turn on the power, have a technician check if the fuse inside the Display Unit has blown. If the fuse has blown, find the cause before replacing the fuse. If the fuse blows again, contact your dealer.

 <b>WARNING</b>
<p> <b>Use the correct fuse.</b></p> <p>A wrong fuse can damage the equipment or cause fire.</p>

Unit	Fuse Rating	Type	Code No.	Qty	Remarks
Display Unit	2A	FGMB-A 125V 2A PBF	000-157-479-10	1	Inside unit
Transceiver Unit	3A	FGBO-A 250V 3A PBF	000-155-841-10	2	Inside unit
Distributor Unit	5A	FGBO-A 250V 5A PBF	000-155-840-10	2	Inside unit
Rate-of-Turn Gyro	2A	FGBO-A 250V 2A PBF	000-155-829-10	1	Inside unit

### 6.2.2 Product life

Unit	Approx. Life (@55°C)	Replacement Part
DS-600 Backlight	30,000 hours	Panel assy.: DS-600 (001-098-070-00)
DS-670 Rate-of-Turn Gyro (Fiber Optic Gyro)	17,520 hours	Model: HOFG-1F (VER1.0)

## 6.3 Troubleshooting

This section provides the troubleshooting procedures that the user can follow to restore normal operation. If you cannot restore normal operation, contact a qualified FURUNO technician for instruction.

Problem	Possible cause	Action
<b>General</b>		
The power cannot be turned on.	Loosened power cable.	Fasten the power cable.
	Blown fuse.	Get a qualified technician to check the fuse in the display unit. Replace the fuse if it has blown.
The power is on, but the screen is black.	The brilliance is too low.	Increase the brilliance.
<b>Doppler speed indication</b>		
The indication does not change (display has frozen) and the speed unit is red.	<ul style="list-style-type: none"> <li>Air bubbles on the transducer face.</li> <li>The ground tracking mode is used when the depth is 200 m or more.</li> </ul>	<ul style="list-style-type: none"> <li>Wait for the air bubbles to disappear.</li> <li>Select the water tracking mode or auto mode.</li> </ul>
The indication shows “_._”	<ul style="list-style-type: none"> <li>Air bubbles on the transducer face.</li> <li>The ground tracking mode is in use when the depth is 200 m or more.</li> </ul>	<ul style="list-style-type: none"> <li>Wait for the air bubbles to disappear. If the problem continues, check the transducer.</li> <li>Select the water tracking mode or auto mode.</li> </ul>
<b>GPS speed, position indication</b>		
The indication shows “_._”	GPS data error.	Check the GPS receiver.
The indication shows hyphens (-) at digit locations.	The GPS receiver is disconnected.	Check the GPS receiver.

## 6.4 Alert Modes and Messages

The DS60 has three alert control modes, [Alert I/F 1], [Alert I/F 2] and [Legacy]. The serviceman sets the mode according to ship classification. The manner in which alerts are displayed and handled changes according to the alert mode selected.

The Distributor Unit monitors the system for alerts. When an alert occurs, an alert message appears at the bottom of the display.

**Note:** Avoid menu operation when there is a communication alert, to prevent malfunction. Restore normal operation before doing menu operations.

### Alert priority

“Alert” is a generic name for a notice to any unusual or potentially dangerous situation generated within the system. The three alert priorities are Alarm, Warning and Caution; this system only generates alerts with Caution priority.

Priority	Description
Caution	Awareness of a condition which continues to require attention out of the ordinary consideration of the situation.

**Alert category**

An alert is further classified by category, A, B or C, according to its degree of severity or source; this system only generates category B alerts.

Category	Description
B	Category B alerts are alerts where no additional information for decision support is necessary. Category B alerts are all alerts not falling under category A.

**6.4.1 Alert messages**

The alert messages are shown on the display, in the [Alert I/F1], [Alert I/F2] and [Legacy] modes.

For the detailed alert messages, see "ALERT LIST" on page AP-6.

**[Legacy] mode**

The [SYSTEM FAIL] is the most important so has the first priority. While the [SYSTEM ERROR] occurs, the [ECHO FAIL] is not displayed even if it has occurred. Do as follows to delete the alert indications.

[SYSTEM FAIL]	<ul style="list-style-type: none"> <li>• <u>For Alert ID 21x:</u> To delete the alert indications, turn off the power.</li> <li>• <u>For Alert ID 22x, 23x:</u> When the reason for alerts are removed, the alert indications disappear.</li> </ul>
[ECHO FAIL]	When the reason for the alert is removed, the alert indications disappear.

**[Alert I/F1] and [Alert I/F2] mode**

For Alert I/F1 and Alert I/F2 modes, alert type has "Caution" only. The detailed information of "Caution" alert is shown as follows.

*Alert icon for alert type "Caution"*

Alert type	Alarm state	Description	Icon	Alarm pattern/audio
Caution	Active	A Caution level alert is active.		Yellow color, lit; audible alarm off.

**How to display the Alert Log and Alert List**

The Alert Log shows the last 100 alerts, while the Active Alert List shows only active alerts.

**<Key operation> (Active alert list only)**

Long-push the **ALARM ACK** key to display the active alert list.

**<Menu operation> (Active alert list, alert log)**

1. Press the **MENU/ESC** key to open the menu.

2. Select [Alert] then press the **ENT** key.

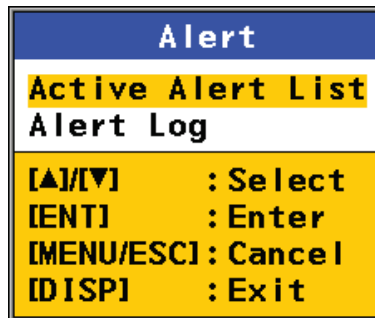

3. Select [Active Alert List] or [Alert Log], as appropriate, then press the **ENT** key. The Active Alert List and Alert Log have a similar appearance and layout, as shown in the figure below.

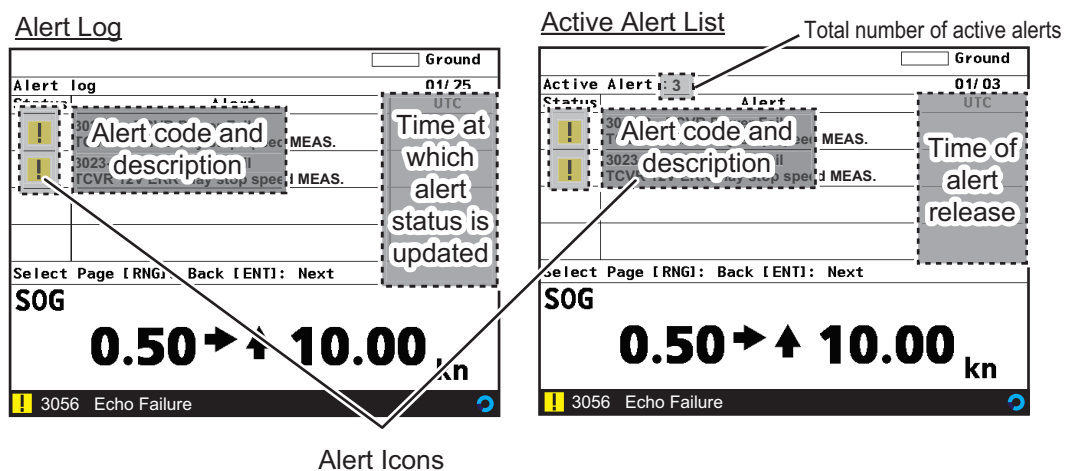

4. Press the **RNG** or **ENT** key to change pages.
5. Press the **MENU/ESC** key several times to close the menus.

## 6.5 Diagnostics

The DS-60 has tests that check the system (Display Unit, Distributor Unit, Transceiver Unit), Display Unit, and LCD.

A short beep sounds if communication error between the DS-600 and DS-610 (or DS-620) occurs during the diagnostic test. If this occurs, check connections and reset the power of the DS-60.

### 6.5.1 System test

The system test checks the Display Unit, Distributor Unit and Transceiver Unit for correct operation.

1. Press the **MENU/ESC** key to open the menu.

## 6. MAINTENANCE

2. Select [TESTS] then press the **ENT** key.

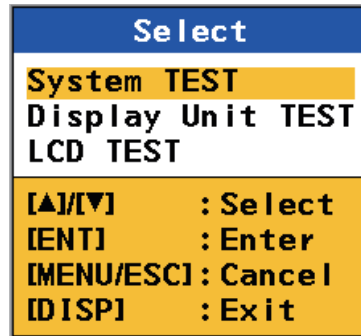

3. Select [System TEST].
4. Press the **ENT** key. The results of the display unit test appear.

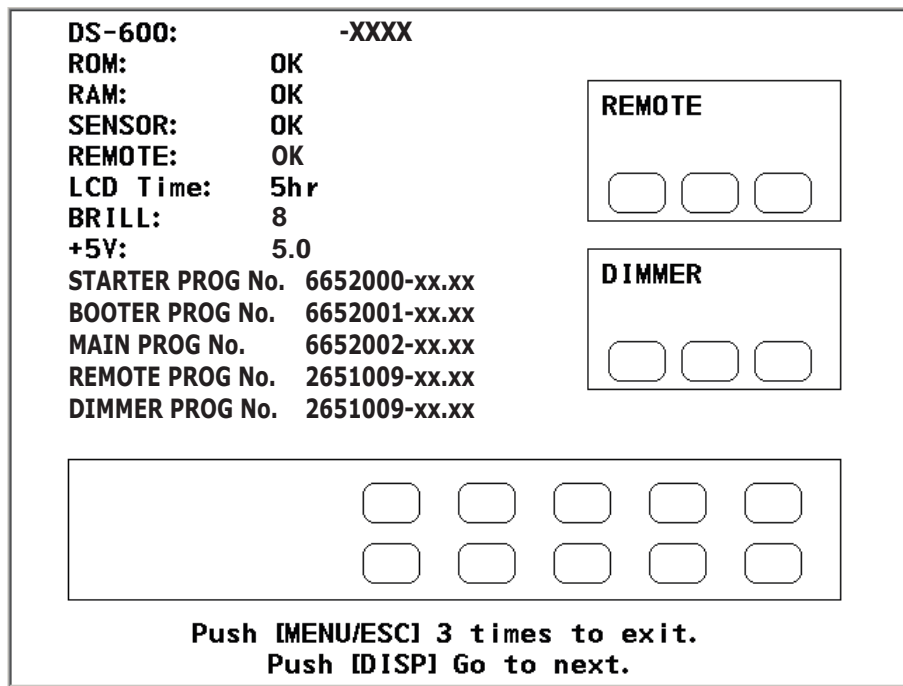

### Description of test results for the Display Unit DS-600

- The results of the ROM and RAM check are shown as OK (normal) or NG (No Good). For any NG, reset the power and try the test again. If the NG condition continues, contact your dealer for instruction.
- "SENSOR" shows the results of the connection test with DS-610. OK for normal, no indication if there is error.
- "REMOTE" shows the results of the connection test with the Remote Controller and Dimmer Controller. Operate the Remote Controller and Dimmer Controller. OK appears if an operation is completed correctly. If the results location is blank, there is no connection or there is no operation from the remote device.
- "LCD Time" shows how many hours the LCD has been on, up to a maximum of 999,999 hours.
- "BRILL" shows the current LCD brilliance setting. Press ▲, ▼. Check that the indication and brilliance level agree.
- "+5V" shows the voltage of the +5.0V circuit.

- The program number of the starter program, booter program, main program, remote program and dimmer program are shown. (The program no. indication is blank where no equipment is not connected.)

The rectangles on the screen are for testing the controls of the Display Unit, Remote Controller and Dimmer Controller. Press any key except the **PWR** and **DISP** keys. The key's on-screen rectangle fills in red if the key is normal. Press the key again and the red fill is removed.

5. Press the **DISP** key to test the Distributor Unit DS-610.

```

DS-610:      XXXX-XXXX
ROM:         OK
RAM:         OK
EEPROM:      OK
SIO
IEC1_IN:
IEC2_IN:
IEC3_IN:
DS-600:      OK
DS-620:      OK
ROT:
ROT Time:    7hr
STARTER PROG No. 6652100-xx.xx
BOOTER PROG No. 6652101-xx.xx
MAIN PROG No.  6652102-xx.xx
FPGA PROG No.  6652103-xx.xx

          Push [MENU/ESC] 3 times to exit.
          Push [DISP]:Go to next.

```

#### **Description of test results for the Distributor Unit DS-610**

- The results of the ROM, RAM and EEPROM check are shown as OK or NG. For any NG, reset the power and try the test again. If the NG condition continues, contact your dealer.
- The input ports IEC1 - IEC3 are the loop-back test for IEC\_IN and IEC\_OUT. The input signals connected to the input ports IEC1 - IEC3 are checked and the results are shown as OK for normal, or no indication if there is no connection.
- The items DS-600, DS-620 and ROT show the results of the connection tests between those units and the DS-610. OK for normal, or no indication for error.
- "ROT Time" shows the number of hours that the Rate-of-Turn Gyro has been powered. The maximum time is 999,999 hours. No indication if there is no connection.
- The program number of the starter program, booter program, main program and FPGA program are shown.

## 6. MAINTENANCE

6. Press the **DISP** key to test the Transceiver Unit DS-620.

```
DS-620:          -5432
ROM:             OK
RAM:             OK
SIO
  DS-610:        OK
B Volt:          120.00
+5V:             5.08
+12V:            12.02
STARTER PROG No. 6652200-XX.XX
BOOTER PROG No. 6652201-XX.XX
MAIN PROG No.    6652202-XX.XX
FPGA1 PROG No.  6652203-XX.XX
FPGA2 PROG No.  6652204-XX.XX
B1 NL:          -16.5dBuV
B2 NL:          -16.4dBuV
B3 NL:          -16.3dBuV

Push [MENU/ESC] 3 times to exit.
Push [DISP] Go to next.
```

XX.XX: Program version no.

### **Description of test results for the Transceiver Unit DS-620**

- The results of the ROM and RAM check are shown as "OK" or "NG". For any "NG", reset the power and try the test again. If the "NG" condition continues, contact your dealer for instruction.
  - "DS-610" shows the results of the connection test with the DS-610. OK for normal, or no indication for error.
  - "B Volt", "+5V" and "+12V" show the voltage of the related circuits.
  - The program number of the starter program, booter program, main program FPGA1 program and FPGA2 program are shown.
  - "B1 NL", "B2 NL" and "B3 NL" mean the noise level for beam 1 to beam 3.
7. To quit the self test, press the **MENU/ESC** key three times.



## 6.5.2 Display unit test

Do the display unit test to check the display unit for correct operation.

1. Press the **MENU/ESC** key to open the menu.
2. Select [TESTS] then press the **ENT** key.
3. Select [Display Unit TEST].
4. Press the **ENT** key, and the results of the display unit test appear.

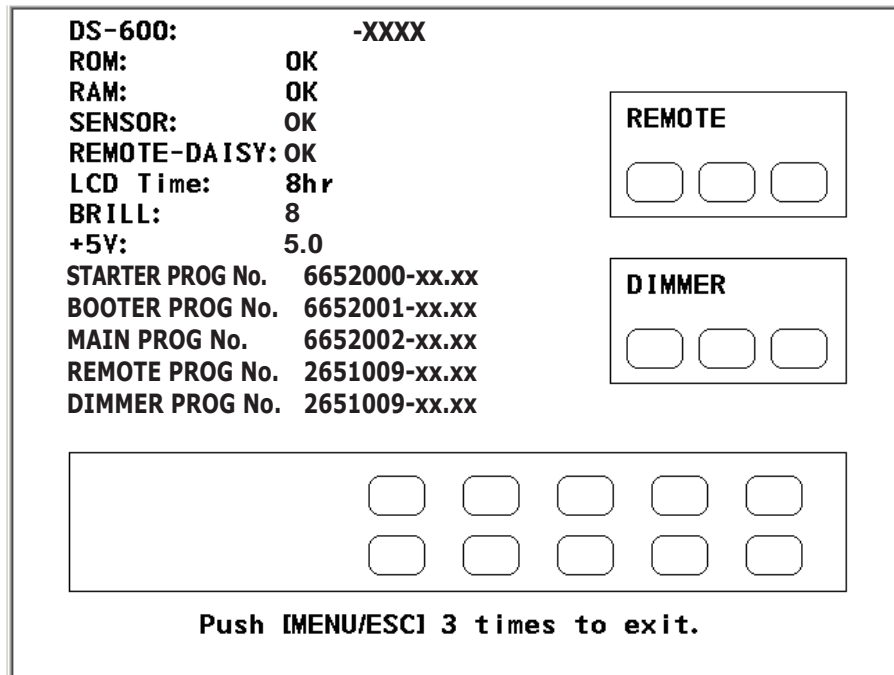

### Description of test results for the Display Unit DS-600

- The results of the ROM and RAM check are shown as OK (normal) or NG (No Good). For any NG, reset the power and try the test again. If the NG condition continues, contact your dealer for instruction.
- "SENSOR", "REMOTE-DAISY" show the results of the serial loop-back test, which requires a special test connector. OK for normal, no indication if there is error.
- "LCD Time" shows how many hours the LCD has been powered, up to a maximum of 999,999 hours.
- "BRILL" shows the current LCD brilliance setting. Press ▲, ▼ to check the brilliance control circuit. Check if the indication and brilliance level agree.
- "+5V" shows the voltage of the +5.0V circuit.
- The program number of the starter program, booter program, main program, remote program and dimmer program are shown. (The program no. indication is blank where no equipment is not connected.)

The rectangles on the screen are for testing the controls of the Display Unit, Remote Controller and Dimmer Controller. Press any key except the **PWR** and **DISP** keys. The key's on-screen rectangle fills in red if the key is normal. Press the key again and the red fill is removed.

5. To quit the self test, press the **MENU/ESC** key three times.

### 6.5.3 LCD test

The LCD test checks the LCD and the brilliance control circuit.

1. Press the **MENU/ESC** key to open the menu.
2. Select [TESTS] then press the **ENT** key.
3. Select [LCD TEST] then press the **ENT** key.
4. Press any key except the **MENU/ESC** key or ▲,▼ to display each color, in the order shown in the figure below. To test the brilliance control circuit, press ▲,▼.

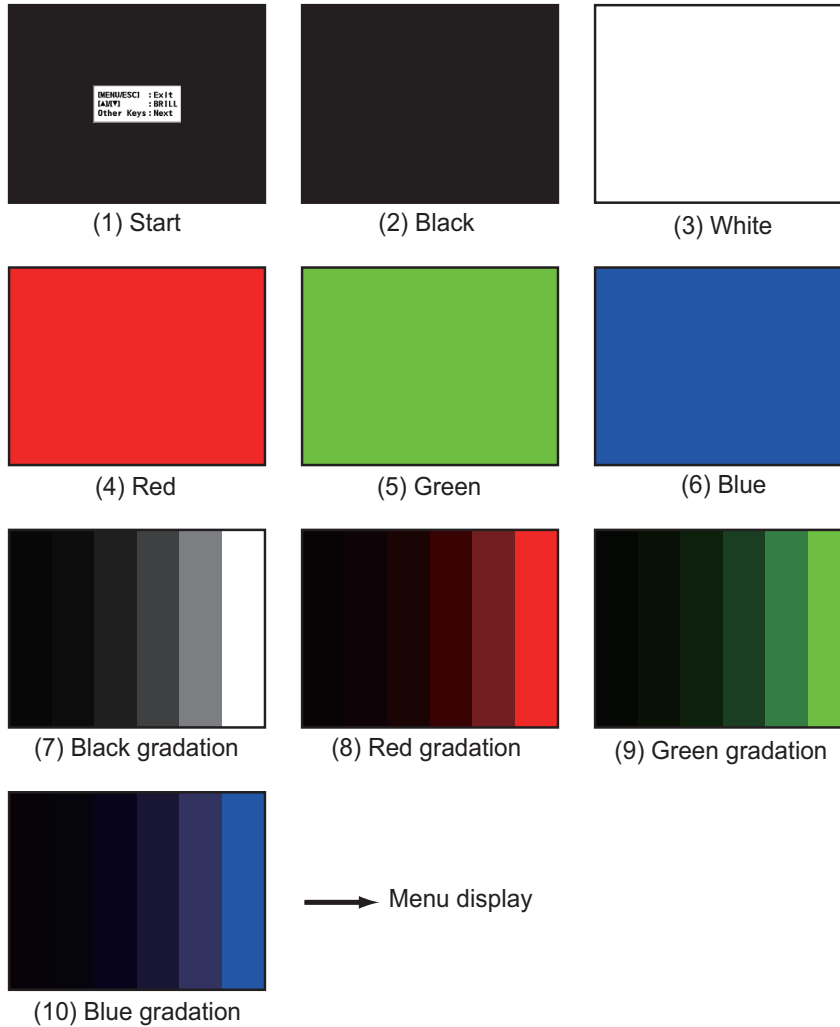

5. Control is returned to the menu after the blue gradation is shown. Press the **DISP** key to close the menu.

## 6.6 TX Monitor

The serviceman uses the TX monitor feature to see the TX condition by amplitude and cycle of waveform.

1. Press the **MENU/ESC** key to open the menu.
2. Select [TX Monitor] then press the **ENT** key.

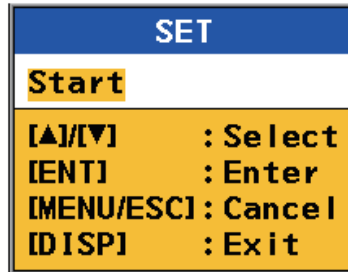

3. [Start] is selected; press the **ENT** key to show the TX monitor display.

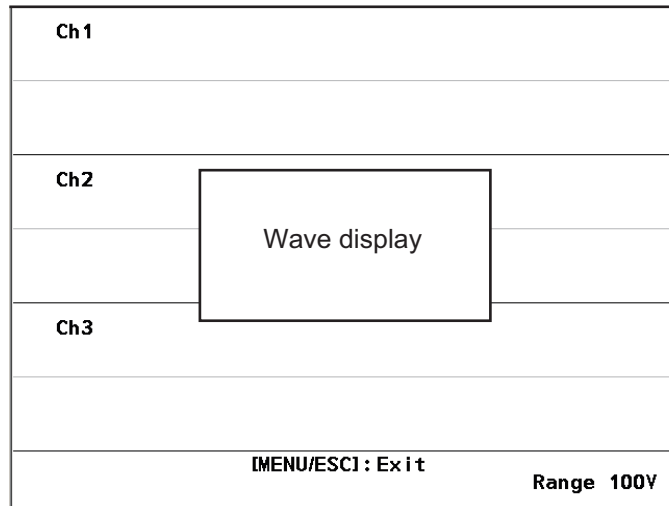

4. To quit the TX monitor, press the **MENU/ESC** key.

## 6.7 Echo Monitor

The serviceman uses the echo monitor feature to see RX condition. If the image from the received beams or channels appear equal, the reception is normal.

1. Press the **MENU/ESC** key to open the menu.
2. Select [Echo Monitor] then press the **ENT** key.

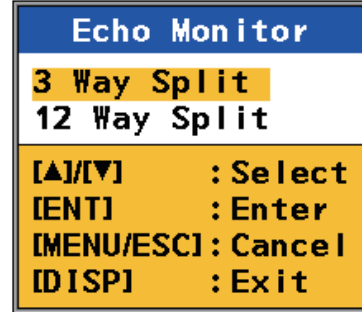

3. Select [3 Way Split] or [12 Way Split].  
 [3 Way Split]: Select beams (1-3) and/or channels (1-9) to monitor. You can select any three to monitor.  
 [12 Way Split]: Monitor all beams (1-3) and all channels (1-9).
4. Press the **ENT** key. One of the following displays appears depending on the selection you made at step 3.

Echoes appear in each block. →

Beam1	Ch1	Ch4	Ch7
Beam2	Ch2	Ch5	Ch8
Beam3	Ch3	Ch6	Ch9
Gain : 31		[MENU/ESC]: Setting	
TX Mode: ON		[DISP] : Clear Echo Data	
Range 200m			

3-way split

12-way split

For [12 Way Split]:

Go to step 5. To clear the echo data, press the **DISP** key.

For [3 Way Split]:

Do the following:

- 1) Select [Point1] then press the **ENT** key.

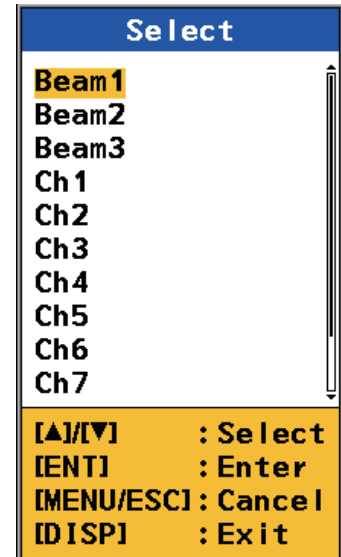

- 2) Select the beam or channel to display then press the **ENT** key.
- 3) Select the beam or channel for [Point2] and [Point3] in the same method. After you selected the beams or channels to show for [Point3], the following screen appears.

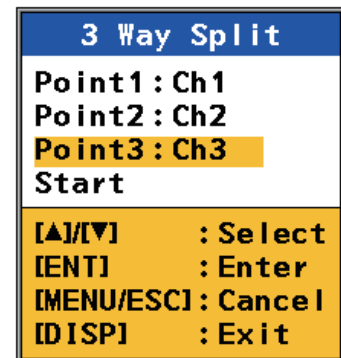

- 4) Select [Start] then press the **ENT** key. The display now shows the echoes from the beams (or channels) selected.

Beam1	Beam2	Beam3
Echoes appear here.	Echoes appear here.	Echoes appear here.
Gain : 31 [MENU/ESC]: Setting TX Mode: OFF [DISP] : Clear Echo Data      Range 5m		

- 5) To change the range, press the **RNG** key. The available ranges are (in meters) 5, 10, 20, 40, 100, 200 and 300. The current range is shown at the bottom right corner on the echo monitor display.
- 6) To clear the echo data, press the **DISP** key.

## 6. MAINTENANCE

5. The [Setting] menu controls the gain, TX mode and exit from the echo monitor. At the echo monitor display, press the **MENU/ESC** key to show the [Setting] menu.

Setting	
Gain	: 31
TX Mode	: OFF
Exit	
[▲]/[▼]	: Select
[ENT]	: Enter
[MENU/ESC]	: Cancel

- 1) You can change the gain to see the echoes under different gain settings.  
Select [Gain] then press the **ENT** key.

SET	
▲	
31	
▼	
(0~40)	
[▲]/[▼]	: Select
[ENT]	: Enter
[MENU/ESC]	: Cancel

- 2) Use ▲ or ▼ to set the gain then press the **ENT** key.
- 3) [TX Mode] on the [Setting] menu stops or starts transmission. [ON] transmits, [OFF] stops transmission. Use [OFF] to monitor noise.
- 4) To monitor other beams or channels, select [Exit] then press the **ENT** key to return to the echo monitor menu.
6. To close the [Setting] menu and return to the echo monitor display, press the **MENU/ESC** key.
7. To quit the echo monitor, press the **MENU/ESC** key to show the [Setting] menu, select [Exit] then press the **ENT** key.

## 6.8 How to Restore Initial Settings

If you feel the equipment is not operating correctly, one cause can be abnormal equipment settings. Try restoring initial settings to restore normal operation. All initial settings are restored, however the alert log, trip distance and total distance run are not reset.

1. Press the **MENU/ESC** key to open the menu.
2. Select [User RESET] then press the **ENT** key.

Select	
Yes	
No	
[▲]/[▼]	: Select
[ENT]	: Enter
[MENU/ESC]	: Cancel
[DISP]	: Exit

3. Select [Yes] then press the **ENT** key.

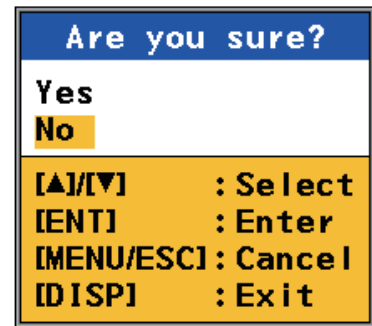

4. Select [Yes] then press the **ENT** key to restore initial settings.

6. MAINTENANCE

This page is intentionally left blank.



# APPENDIX 1 MENU TREE

Menu key

***Bold Italic*** : Default

\*1 *Main display unit only*

\*2 *Sub display unit only*

\*3 *Refer to Installation Manual*

- └ Ship's time
  - └ Source (Internal, -13:00 to +13:00, **NAV EQUIP**)
  - └ Summer Time (ON, **OFF**)
- └ Trip DIST \*1 (SET(000000.00 to 999999.99(NM), RESET)
- └ Ship's Track (**Past+Predict**, Past, Predict, OFF)
- └ Plot Time (1 min, 2 min, **5 min**, 10 min, 20 min, 30 min)
- └ Past Tracks (**ON**, OFF)
- └ Vector Time (30 s, 1 min, 2 min, **5 min**, 10 min, 20 min)
- └ Display (DISP1 to DISP7, arrange displays)
 

**DISP 1:** Navigation  
**DISP 2:** Berthing H Up  
**DISP 3:** HDG.Speed 3-axis  
**DISP 4:** Trip DIST + Total DIST  
**DISP 5:** Main, no display, Sub, Speed Graphic  
**DISP 6, DISP7:** No display
- └ Scale Set Up
  - └ Speed Graphic \*2
    - └ DISP1
      - └ Astern SPD Scale (**5 kn (2.5 m/s, 10 km/h)**, 10 kn (5.0 m/s, 20 km/h), 15 kn (7.5 m/s, 30 km/h), 20 kn (10.0 m/s, 40 km/h), 25 kn (12.5 m/s, 50 km/h), 30 kn (15.0 m/s, 60 km/h), 35 kn (17.5 m/s, 70 km/h))
      - └ Ahead SPD Scale (Same as Astern, default **25kn (12.5 m/s, 50 km/h)**)
    - └ DISP2 to DISP 7 (Same as DISP1)
  - └ Depth REF (**EXT DBK**, EXT DBT, INT DBT)
  - └ Direction SYM (**Arrows**, Text)
  - └ SYM Location (**Left**, Right)
  - └ Berthing Range (**50 m (0.025 NM), 75 m (0.04 NM), 100 m (0.50 NM), 150 m (0.075 NM), 200 m (0.100 NM)**, 250 m (0.125 NM), 300 m (0.150 NM), 400 m (0.200 NM), 600 m (0.300 NM), 800 m (0.400 NM), 1000 m (0.500 NM), Save)
  - └ Berthing Data Display (**3 axis in NAV**, 3 axis and NAV, 3 axis)
  - └ CUR Direction (**Flow to**, Flow from)
  - └ Mode
    - └ Wind (**True**, Theoretical, Relative, OFF)
    - └ Time (**UTC**, Ship's Time)
- └ **Initialize**
  - └ Total DIST \*1 (SET(0 NM to 999,999.99 NM), RESET)
  - └ Speed Limit Alarm \*1 (SET, **40.0 kn**, (0.00 kn to 40.00 kn), OFF)
  - └ Berthing Line \*1 (**Edit**, Share, Delete)
  - └ Wind Average (No Averaging, **1 min**, 2 min, 3 min, 5 min, 10 min)
  - └ Key Beep (**ON**, OFF)
  - └ Key BRILL (1, **2**, 3, 4, 5, 6, 7, 8)
  - └ Speed Select \*2 (**Forward-After**, Vector)

Continued on following page.

Continued from previous page.

- └ Echo Monitor \*1
  - └ 3 Way Split
    - └ Point 1 (**Beam 1**, Beam 2, Beam 3, Ch1, Ch2, Ch3, Ch4, Ch5, Ch6, Ch7, Ch8, Ch9)
    - └ Point 2 (Same choices as Point 1. Default - **Beam 2**)
    - └ Point 3 (Same choices as Point 1. Default - **Beam 3**)
    - └ Start
  - └ 12 Way Split
- └ TX Monitor \*1 (Start)
- └ Alert \*1
  - └ Active Alert List
  - └ Alert Log
- └ ROT Sensor \*1 (**Internal**, External ROT, External HDG)
- └ TESTS (System TEST, Display Unit TEST, LCD TEST)
- └ System \*1
  - └ System Parameters
    - └ Ship's Speed Average (5 s, **10 s**, 15 s, 30 s, 60 s)
    - └ Current Average (1 min, 2 min, **3 min**, 5 min, 10 min)
    - └ Track Depth (0.5 m to 25.0 m; default **1.0 m**)
    - └ Current Measurement (0.5 m to 25.0 m; default **2.0 m**)
    - └ CALC Average (No Averaging, 10 s, 30 s, **60 s**, 90 s, 120 s)
    - └ IR (ON, **OFF**)
    - └ Log Pulse Speed (**STW&GPS**, SOG&STW&GPS, SOG&GPS, STW)
    - └ Log Pulse Output (Forward, **Forward-After**, Vector)
    - └ Beam Direction (**Forward**, After)
    - └ TVG Curve (**0** to 19)
    - └ ECHO FAIL Limit (**0** to 9)
  - └ Offset Data \*3
    - └ Trim (-12.5 deg to +12.5 deg)
    - └ Heel (-12.5 deg to +12.5 deg)
    - └ XDCR (-60.0 deg to +60.0 deg)
    - └ Compass Calibration (-12.5 deg to +12.5 deg)
    - └ SOG Calibration (-12.5% to +12.5%)
    - └ STW Calibration (-12.5% to +12.5%)
  - └ Setting Ship's Data \*3
    - └ LOA (50.0 m to 400.0 m)
    - └ B (5.0 m to 100.0 m)
    - └ L1 (0.0 m to LOA)
    - └ L2 (0.0 m to B)
    - └ L3 (0.0 m to LOA)
    - └ L4 (0.0 m - B)
    - └ L5 (0.0 m - LOA)
    - └ D (0.0 m - LOA-L1)
  - └ User Reset (Yes, **No**)

# APPENDIX 2 ABBREVIATIONS

---

Below is a list of abbreviations used in this manual and in the DS-60.

## General

Abbreviation	Meaning
ACK	Acknowledge
ADJ	Adjustment
AFT	Aft
ALARM	Alarm
AUTO	Automatic
B	Breadth
B1	Beam1
B2	Beam2
B3	Beam3
BAM	Bridge Alert Management (System)
BRILL	Brilliance
BV	B Voltage
CALC	Calculate
CCRP	Consistent Common Reference Point
COG	Course Over The Ground
COM	Communication
CTRL	Control
CUR	Current
DAISY	Daisy-chain
DBK	Depth Below Keel
DBT	Depth Below Transducer
deg	Degree, degrees
DEL	Delete
DIMMER	Dimmer Controller
DISP	Display
DIST	Distance
DPTH	Depth
DRIFT	Drift Angle
E	East
ECHO	Echo
EEPROM	Electrically Erasable Programmable Read-Only Memory
ENT	Enter
ERR	Error
ESC	Escape
EXT	External
FAIL	Failure
FPGA	Field-Programmable Gate Array
FWD	Forward
GAIN	Gain
GPS	Global Positioning System
H UP	Head Up
HDG	Heading

APPENDIX 2 ABBREVIATIONS

Abbreviation	Meaning
I/O	Input/Output
IEC	IEC61162
IN	Input
INT	Internal
IR	Interference Rejector
L	Length
L/L	Latitude/Longitude
LAT	Latitude
LCD	Liquid Crystal Display
LOA	Length Overall
LON	Longitude
MAX	Maximum
MEAS	Measurement
MENU	Menu
MIN	Minimum
MODE	Mode
N	North
N UP	North Up
NAV	Navigation
NG	No Good
NL	Noise Level
NM	Nautical Mile, Nautical Miles
NT	Night
OPT	Optical
P	Port
POSN	Position
PRED	Predicted
PROG	Program
PS	Power Supply
PWR	Power
R	Relative
RAM	Random Access Memory
REF	Reference
REMOTE	Remote Controller
RNG	Range
ROM	Read Only Memory
ROT	Rate Of Turn
RX	Receive
S	South
S	Starboard
SEL	Select
SENSOR	Sensor
SIM	Simulation
SIO	Serial Input/Output
SOG	Speed Over The Ground
SPD	Speed
STBD	Starboard
STW	Speed Through The Water
SYM	Symbol

<b>Abbreviation</b>	<b>Meaning</b>
T	True
TCVR	Transceiver
TEMP	Temperature
TEST	Test
TH	Theoretical
TRK	Track
TRKG	Tracking
TVG	Time Variable Gain
TX	Transmit
UNIT	Unit
UTC	Coordinated Universal Time
VECT	Vector
W	West
WPT	Waypoint
XDCR	Transducer

### Unit

<b>Abbreviation</b>	<b>Meaning</b>
deg or °	degree(s)
fm	fathom(s)
ft	feet / foot
hrs	hours
km	kilometer(s)
km/h	kilometers per hour
kn	knot(s)
m	meter(s)
m/DIV	meters per division
m/s	meters per second
min or '	minute(s)
mph	miles per hour
NM	nautical mile(s)
NM/DIV	nautical miles per division
s or "	second(s)

# APPENDIX 3 ALERT LIST

The table which follows shows the alert messages that can appear on the display, in the [Alert I/F1], [Alert I/F2] and [Legacy] modes.

**Note:** The following features are **NOT** supported.

- Alert aggregation
- Functional alert grouping
- Responsibility transfer (The alert type of DS-60 is "Caution" only.)
- Alert Escalation (The alert type of DS-60 is "Caution" only.)

Legacy Mode	Alert I/F1 Mode	Alert I/F2 Mode
!! 310 Echo Failure	!! 011 Echo Failure	!! 3056 Echo Failure

Alert title	Alert description text	Priority	Alert category	Alert ID			Meaning	Measures
				Legacy	Alert I/F 1	Alert I/F 2		
Lost MEAS	TCVR PS ERR stopped speed MEAS.	Caution	B	210	001	3009-1	Ship speed measurement stops because transceiver unit's transmission high voltage circuit is abnormal.	Contact your dealer.
Lost MEAS	TCVR BV ERR stopped speed MEAS.	Caution	B	211	002	3009-2	Ship speed measurement stops because transceiver's transmission high voltage is outside specified range.	
Lost MEAS	TCVR 5V ERR stopped speed MEAS.	Caution	B	212	003	3009-3	Ship speed measurement stops because transceiver's 5V voltage is outside specified range.	
Lost MEAS	TCVR 12V ERR stopped speed MEAS.	Caution	B	213	004	3009-4	Ship speed measurement stops because transceiver's 12V voltage is outside specified range.	
Missing ROT	ROT TEMP ERR stops 3-axis speed.	Caution	B	220	005	3119-1	Ship speed measurement of "Bow" and "Center" stops because temperature in ROT GYRO chassis outside specified range.	
Missing ROT	ROT OPT ERR stops 3-axis speed.	Caution	B	221	006	3119-2	Ship speed measurement of "Bow" and "Center" stops because ROT GYRO optical system damaged (Possible light source failure).	
Missing ROT	ROT CTRL ERR stops 3-axis speed.	Caution	B	222	007	3119-3	Ship speed measurement of "Bow" and "Center" stops because ROT GYRO control damaged.	
Lost DISP	DISP COM ERR stops display update.	Caution	B	231	008	3003-1	Display update stops because communication error with display unit.	
Lost TCVR	TCVR COM ERR stops speed MEAS.	Caution	B	232	009	3003-2	Ship speed measurement stops because communication error with transceiver unit.	
Echo Failure	RX echo ERR reduces reliability.	Caution	B	310	011	3056	The speed reliability is reduced because the received echo is affected by bubbles and noise.	

To access the [Alert Log] or [Active Alert List], see "How to display the Alert Log and Alert List" on page 6-4.

# APPENDIX 4 PARTS LIST, PARTS LOCATION

This chapter shows only the modules/components/parts that can be replaced in shipboard maintenance (IMO A.694(17)/8.3.1). Main modules are shown on the parts location illustrations, which follow the parts list.

## Parts List

UNIT	PRINTED CIRCUIT BOARD/ ASSY. TYPE	CODE NO.
2011/4		
Model	DOPPLER SONAR DS-60	
Unit	DISPLAY UNIT DS-600 DISTRIBUTOR UNIT DS-610 TRANSCIVER UNIT DS-620 JUNCTION BOX DS-640 JUNCTION BOX DS-645A JUNCTION BOX DS-645B REMOTE CONTROLLER RD-501 DIMMER CONTROLLER RD-502	
<b>DISPLAY UNIT DS-600</b>		
MAIN BOARD	26P0006	001-098-030
PNL BOARD	26P0007	001-098-050
MCN BOARD	02P6345	001-098-080
LCD	NL6448BC26-22F	000-171-704-10
<b>DISTRIBUTOR UNIT DS-610</b>		
MAIN BOARD	66P3950	001-090-660
I/F BOARD	66P3951	001-090-650
CONT BOARD	66P3952	001-090-630
ZNR BOARD	66P3953	001-090-610
<b>TRANSCIVER UNIT DS-620</b>		
MAIN BOARD	66P3960	001-097-930
TX BOARD	66P3961	001-090-720
PWR BOARD	66P3962	001-090-690
FIL BOARD	66P3964	001-090-700
<b>JUNCTION BOX DS-640</b>		
JTB BOARD	66P3970	001-090-800
<b>JUNCTION BOX DS-645A</b>		
JTB BOARD	66P3970 (LF)	001-083-610
<b>JUNCTION BOX DS-645B</b>		
JTB BOARD	66P3970 (LF)	001-083-610
<b>REMOTE CONTROLLER RD-501, DIMMER CONTROLLER RD-502</b>		
RMT BOARD	26P0012	001-076-930

APPENDIX 4 PARTS LIST, PARTS LOCATION

Parts Location

*Display Unit DS-600*

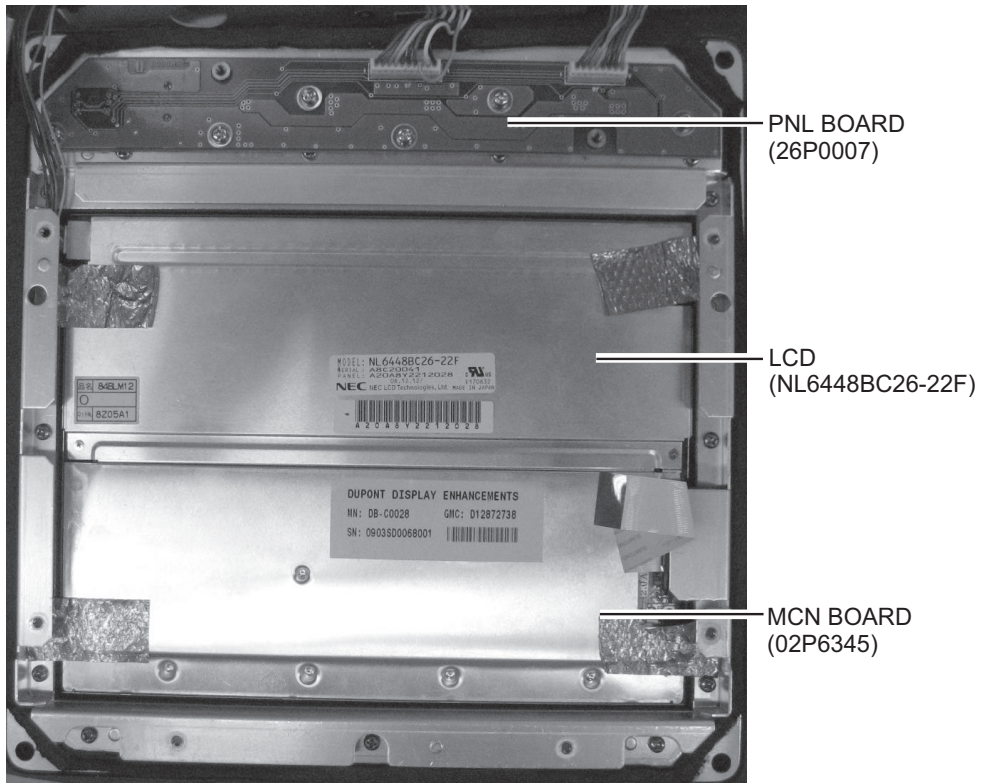

*Display Unit DS-600, front panel assembly*

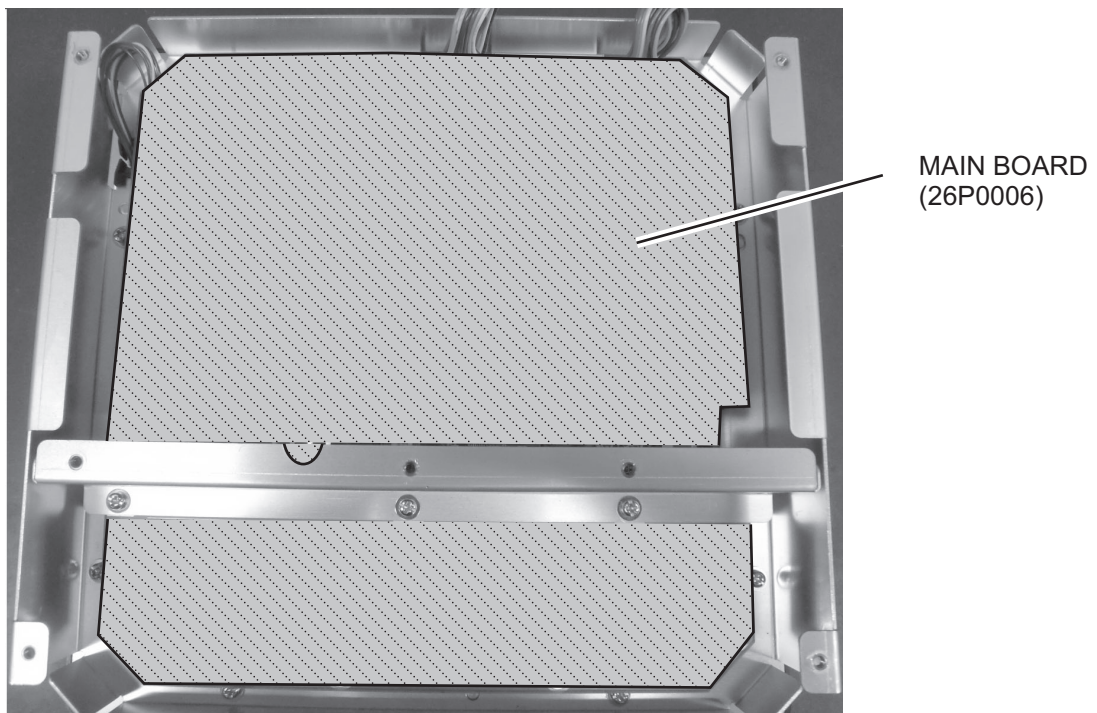

*Display Unit DS-600, rear panel assembly*



*Distributor Unit DS-610*

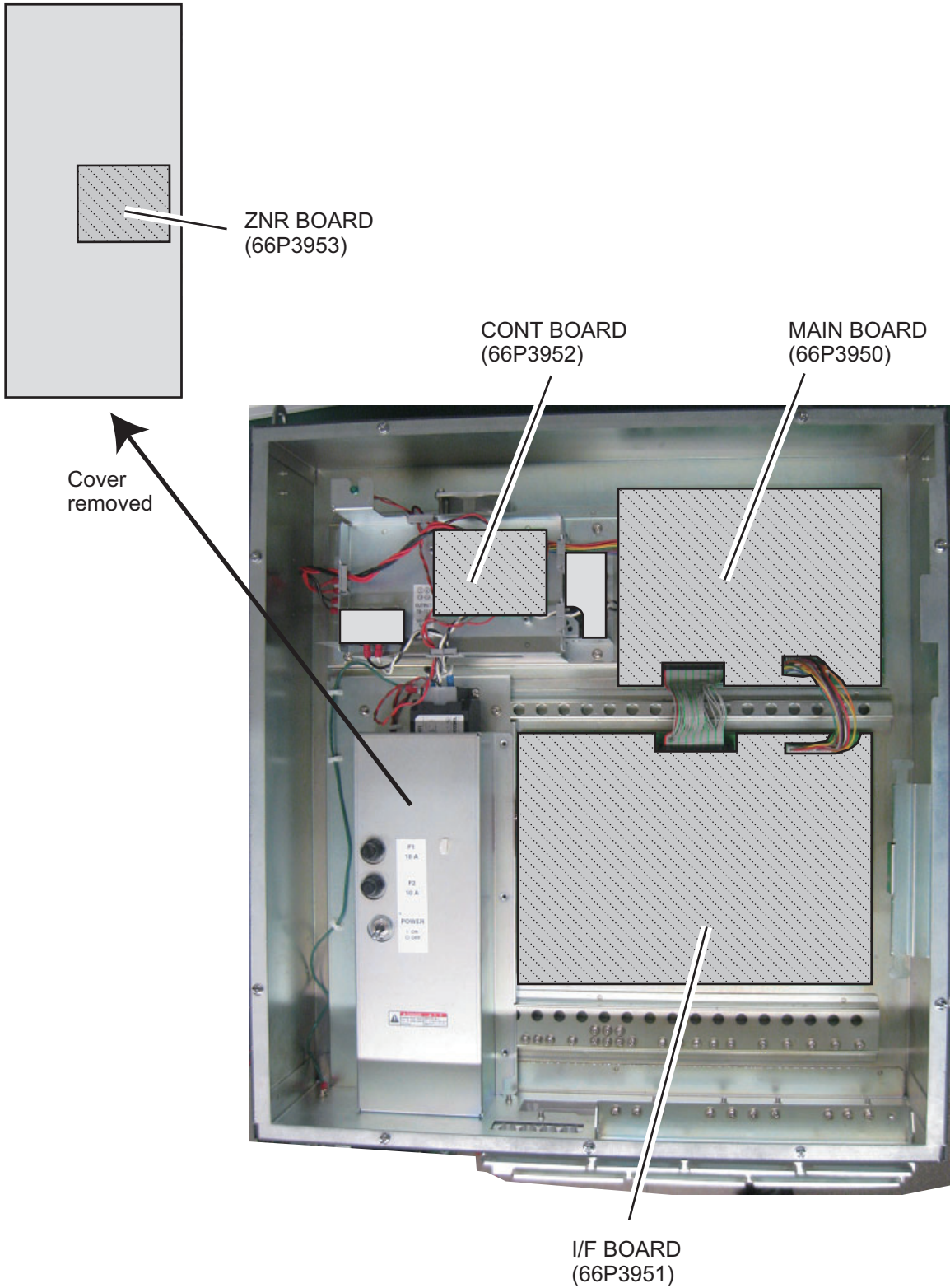

*Distributor Unit DS-610*

APPENDIX 4 PARTS LIST, PARTS LOCATION

*Transceiver Unit DS-620*

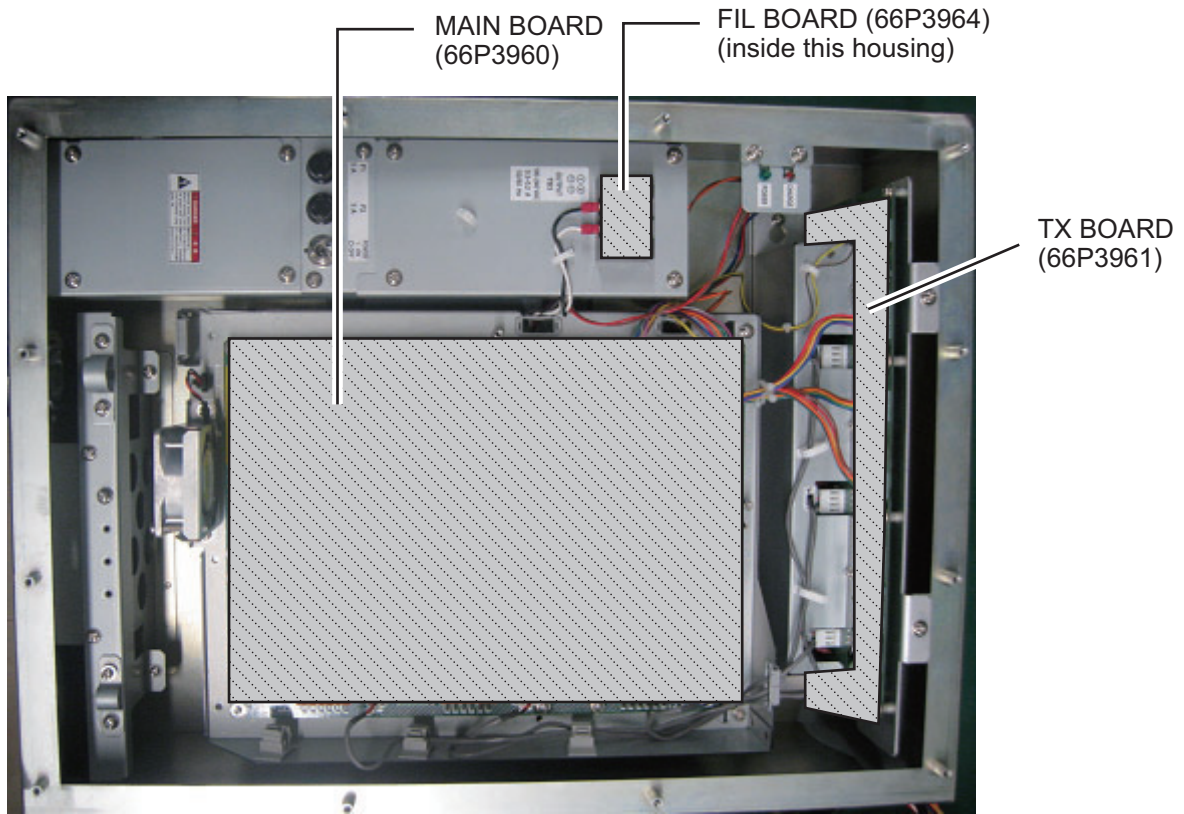

*Transceiver Unit DS-620*

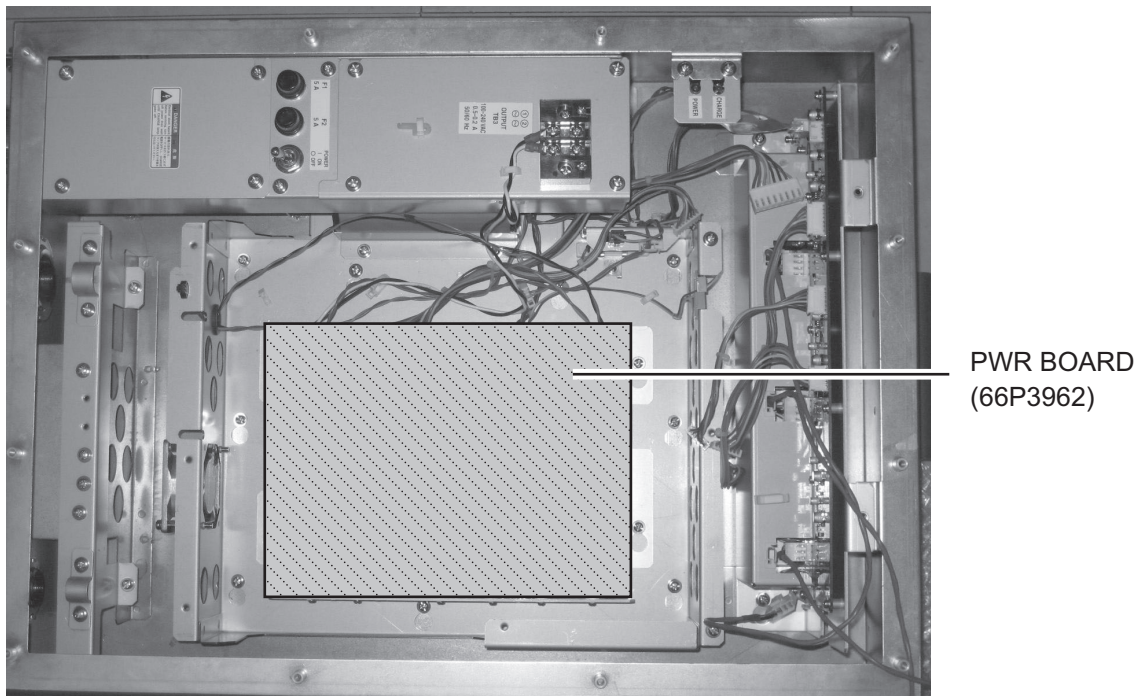

*Transceiver Unit DS-620, MAIN BOARD (66P3960) removed*

*Junction Box DS-640*

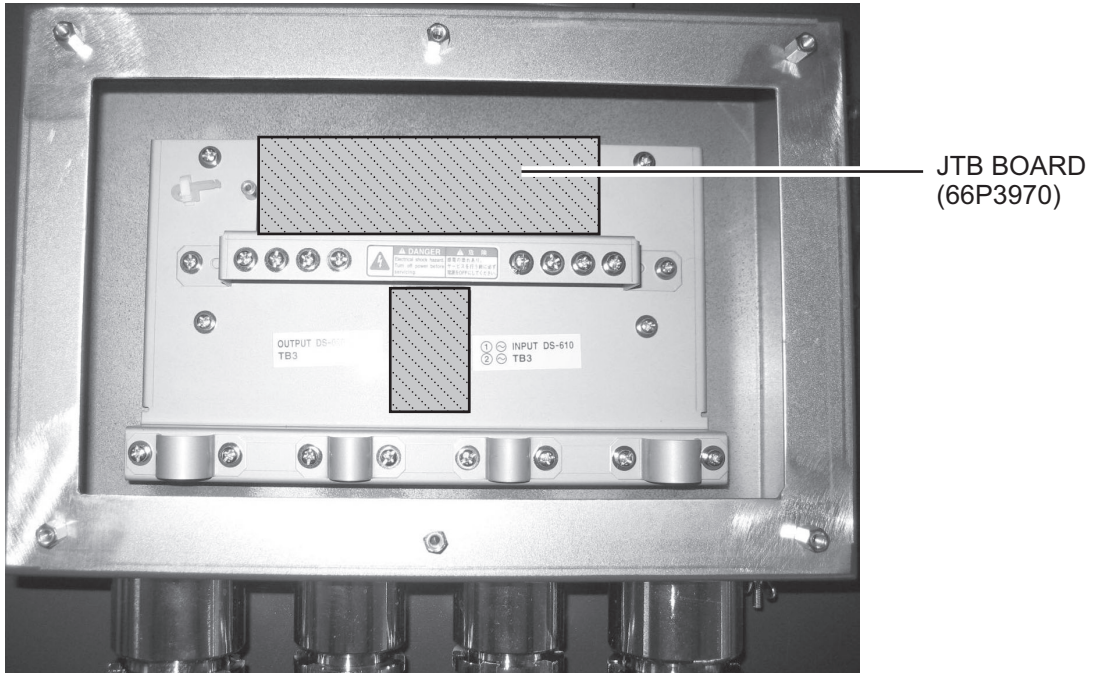

*Junction Box DS-640*

*Remote Controller RD-501, Dimmer Controller RD-502*

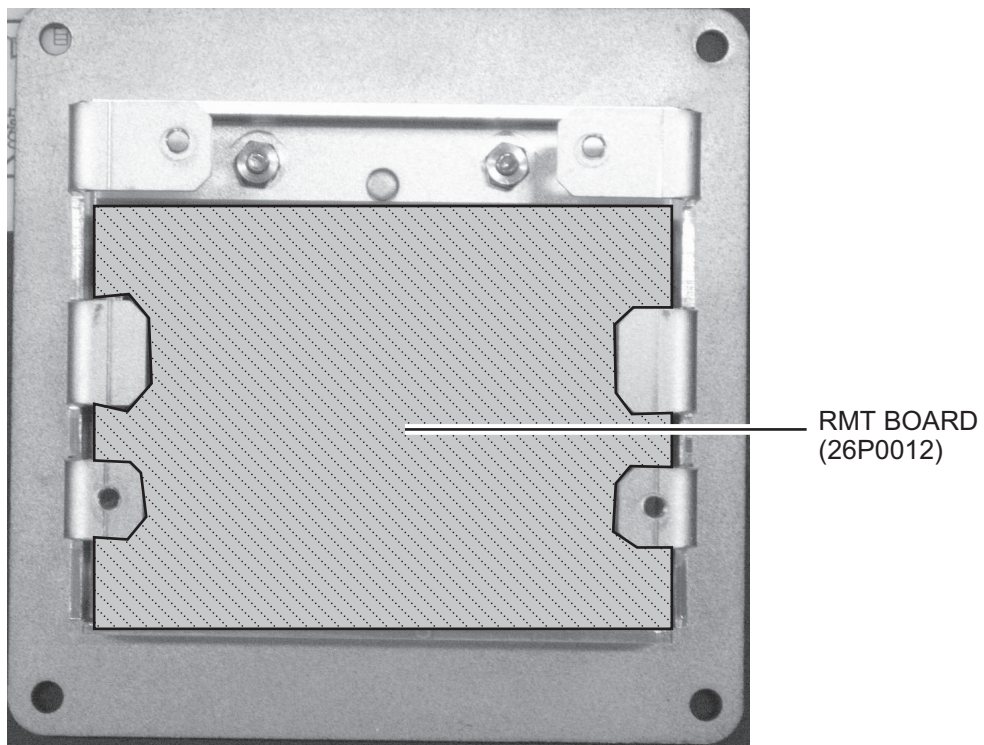

*Remote Controller RD-501*



	Alarm output (contact closure):	4 ports
	- Power failure, System failure, Echo failure, Limit of speed	
	Local ACK (contact closure):	1 port
3.3	Input sentences	ACN, DBT, DPT, GGA, GLL, GNS, HDG, HDT, MWV, RMC, ROT, THS, VTG, ZDA
3.4	Output sentences	ALC, ALF, ALR, ARC, VBW, VDR, VHW, VLW, VTG

#### **4 RATE-OF-TURN GYRO CONVERTER (OPTION)**

4.1	Method	Optical fiber
4.2	Measurement range	Within $\pm 5^\circ/\text{s}$
4.3	Light emitter's life	17,000 hrs approx. (+55°C)
4.4	Source	100-240 VAC: 0.15 A max, 1 phase, 50/60Hz

#### **5 POWER SUPPLY**

100-240 VAC: 1.6- 0.9 A, 1 phase, 50/60Hz

#### **6 ENVIRONMENTAL CONDITION**

6.1	Ambient temperature	
	Main display unit	-25°C to +55°C
	Others	-15°C to +55°C
6.2	Relative humidity	93% or less at +40°C
6.3	Degree of protection	
	Main display unit	IP56 (front panel)
	Transceiver unit/ Junction box	IP44
	Distributor	IP22
6.4	Vibration	IEC 60945

#### **7 COATING COLOR**

N2.5



# INDEX

---

## A

Abbreviations .....AP-3  
ALARM ACK key..... 1-2, 2-10  
Analog output.....5-10  
Analog speed .....5-10

## B

Background alert icon .....2-2  
Beam direction .....5-10  
Berthing display  
  description.....3-1  
  range .....3-3  
Berthing line  
  creating .....3-9  
  deleting.....3-14  
  sharing .....3-13

## BRILL key

  dimmer controller ..... 1-3, 1-5  
  main display unit ..... 1-2, 1-5

## Brilliance

  display .....1-5  
  key (dimmer) .....5-4

## C

Control description  
  dimmer controller ..... 1-3  
  display unit ..... 1-1  
  remote controller ..... 1-3  
Current averaging .....5-10  
Current direction format .....2-6  
Current measurement depth .....5-10

## D

DAY/NT key  
  dimmer controller ..... 1-3, 1-9  
  main display unit ..... 1-2, 1-9  
Depth measurement reference .....2-6  
Dimmer controller.....1-3  
Direction symbols  
  format .....5-5  
  location (nav data and berthing displays).5-6  
  speed graphic display .....4-3  
DISP key  
  main display unit .....1-1, 1-5, 1-7  
  remote controller .....1-3, 1-5, 1-7  
Display arrangement.....5-1  
Display unit controls .....1-1  
Display unit test.....6-9

## E

Echo monitor .....6-12  
ENT key ..... 1-2, 1-8  
Error message .....6-3

## F

Fuse .....6-2

Fuse replacement .....6-2

## H

Heading averaging .....5-10

## I

Initial settings restore .....6-14  
Interference rejector .....5-10

## K

Key beep .....5-4  
Key dimmer .....5-4

## L

LCD test .....6-10  
Log pulse output .....5-10  
Log pulse speed source .....5-10

## M

Maintenance .....6-1  
Menu operation .....1-9  
Menu tree .....AP-1  
MENU/ESC key..... 1-2, 1-7  
MODE key (remote controller) ..... 1-3, 1-6

## N

Navigation data display  
  description .....2-1  
  indications ..... 2-1, 2-2  
Navigation data ON/OFF.....3-8

## P

Parts list .....AP-7  
Parts location .....AP-8  
Past track  
  description.....3-4  
  format .....3-6  
  ON/OFF .....3-5  
Power on/off .....1-4  
Predicted track  
  description .....3-5  
  ON/OFF .....3-5  
  plot time .....3-6  
Product life .....6-2  
PWR key ..... 1-1, 1-4

## R

Range (berthing display) .....3-3  
Remote controller .....1-3  
RNG key ..... 1-2, 3-3  
ROT sensor .....2-9

## S

Ship vector .....3-7  
Ship's speed averaging .....5-10  
Speed alarm.....2-10  
Speed graphic display  
  activating .....4-2  
  description .....4-1

format .....	4-5
indications .....	4-1
System configuration.....	viii
System test .....	6-5

**T**

Time	
format .....	2-4
local time .....	2-3
source .....	2-3
summer time (daylight savings time).....	2-3
Total distance run	
resetting .....	5-7
setting.....	5-8
Track	
past track.....	3-4
past track format .....	3-6
predicted track.....	3-5
predicted track plot interval .....	3-6
type to display .....	3-5
Tracking depth .....	5-10
Tracking mode .....	1-6
Tracking mode monitor .....	1-6
Trip distance.....	1-8
TRKG MODE key.....	1-2, 1-6
Troubleshooting .....	6-3
TVG curve .....	5-10
Tx monitor .....	6-11

**U**

UNIT key	
main display unit .....	1-2, 1-7
remote controller .....	1-3, 1-7
Units .....	1-7

**W**

Wind angle .....	2-8
Wind averaging time .....	2-9

## Declaration of Conformity



# 0560

We **FURUNO ELECTRIC CO., LTD.**

(Manufacturer)

9-52 Ashihara-Cho, Nishinomiya City, 662-8580, Hyogo, Japan

(Address)

declare under our sole responsibility that the product

**DOPPLER SONAR DS-60**  
(Serial No. 2261/2266-xxxx)

(Model name, type number)

to which this declaration relates conforms to the following standard(s) or normative document(s)

IMO Resolution A.694(17)	IEC 61023 Ed.3.0: 2007
IMO Resolution A.824(19)	IEC 61162-1 Ed. 5.0: 2016
IMO Resolution MSC.36(63)	IEC 62288 Ed.2.0: 2014
IMO Resolution MSC.97(73)	IEC 60945 Ed.4.0: 2002 incl. Corr. 1: 2008
IMO Resolution MSC.191(79)	IEC 62923-1/2 Ed.1.0: 2018
IMO Resolution MSC.302(87)	

(title and/or number and date of issue of the standard(s) or other normative document(s))

For assessment, see

- EC Type Examination (Module B) certificate No. MEDB000008R Rev.4 issued by DNV AS (0575), Norway.
- Product Quality System (Module D) certificate No. P 112 (Issue 67) issued by Telefication, The Netherlands.

This declaration is issued according to the Directive 2014/90/EU of the European Parliament and of the Council on marine equipment, and the Implementing Regulation (EU) 2022/1157.

On behalf of Furuno Electric Co., Ltd.

Nishinomiya City, Japan  
2 December 2022

(Place and date of issue)

Akihiko Kanechika  
Department General Manager  
Quality Assurance Department

(name and signature or equivalent marking of authorized person)