

# **FURUNO**

## **OPERATOR'S MANUAL**

*NAVIGATIONAL ECHO SOUNDER*

Model

**FE-800**

---



# IMPORTANT NOTICES

---

## General

- This manual has been authored with simplified grammar, to meet the needs of international users.
- The operator of this equipment must read and follow the instructions in this manual. Wrong operation or maintenance can void the warranty or cause injury.
- Do not copy any part of this manual without written permission from FURUNO.
- If this manual is lost or worn, contact your dealer about replacement.
- The contents of this manual and the equipment specifications can change without notice.
- The example screens (or illustrations) shown in this manual can be different from the screens you see on your display. The screens you see depend on your system configuration and equipment settings.
- Save this manual for future reference.
- Any modification of the equipment (including software) by persons not authorized by FURUNO will void the warranty.
- The following concern acts as our importer in Europe, as defined in DECISION No 768/2008/EC.
  - Name: FURUNO EUROPE B.V.
  - Address: Siriusstraat 86, 5015 BT, Tilburg, The Netherlands
- The following concern acts as our importer in UK, as defined in SI 2016/1025 as amended SI 2019/ 470.
  - Name: FURUNO (UK) LTD.
  - Address: West Building Penner Road Havant Hampshire PO9 1QY, U.K.
- All brand, product names, trademarks, registered trademarks, and service marks belong to their respective holders.

## How to discard this product

Discard this product according to local regulations for the disposal of industrial waste. For disposal in the USA, see the homepage of the Electronics Industries Alliance (<http://www.eiae.org/>) for the correct method of disposal.

## How to discard a used battery

Some FURUNO products have a battery(ies). To see if your product has a battery, see the chapter on Maintenance. If a battery is used, tape the + and - terminals of battery before disposal to prevent fire, heat generation caused by short circuit.

### In the European Union

The crossed-out trash can symbol indicates that all types of batteries must not be discarded in standard trash, or at a trash site. Take the used batteries to a battery collection site according to your national legislation and the Batteries Directive 2006/66/EU.

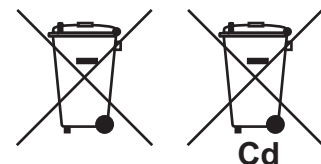

### In the USA

The Mobius loop symbol (three chasing arrows) indicates that Ni-Cd and lead-acid rechargeable batteries must be recycled. Take the used batteries to a battery collection site according to local laws.

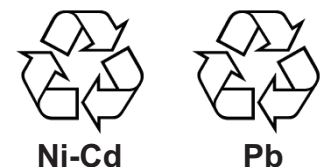

### In the other countries

There are no international standards for the battery recycle symbol. The number of symbols can increase when the other countries make their own recycle symbols in the future.



# SAFETY INSTRUCTIONS

The operator must read the safety instructions before attempting to operate the equipment.



## WARNING

Indicates a potentially hazardous situation which, if not avoided, could result in death or serious injury.



## CAUTION

Indicates a potentially hazardous situation which, if not avoided, could result in minor or moderate injury.



Warning, Caution



Prohibitive Action



Mandatory Action



## WARNING



### Do not open the equipment.

The equipment uses high voltage that can cause electrical shock. Refer any repair work to a qualified technician.



### If water leaks into the equipment or something is dropped into the equipment, immediately turn off the power at the switchboard.

Fire or electrical shock can result.



### If the equipment is giving off smoke or fire, immediately turn off the power at the switchboard.

Fire or electrical shock can result.



### If you feel the equipment is acting abnormally or giving off strange noises, immediately turn off the power at the switchboard and contact a FURUNO service technician.



## WARNING



### Do not disassemble or modify the equipment.

Fire, electrical shock or serious injury can result.



### Make sure no rain or water splash leaks into the equipment.

Fire or electrical shock can result if water leaks into the equipment.



### Do not place liquid-filled containers on or near the equipment.

Fire or electrical shock can result if a liquid spills into the equipment.











### Do not operate the equipment with wet hands.

Electrical shock can result.





### Use the proper fuse.

Use of the wrong fuse can cause fire or electrical shock.

 <b>CAUTION</b>	
	<p><b>Handle the LCD carefully.</b></p> <p>The LCD is made of glass, which can cause injury if broken.</p>
	<p><b>Do not transmit with the transducer out of water.</b></p> <p>Damage to the transducer can result.</p>
	<p><b>Properly adjust the gain.</b></p> <p>Too little gain gives no picture. Too much gain shows excessive noise on the picture. Using the depth data for navigation when the gain is incorrectly set can lead to a dangerous situation.</p> <div style="display: flex; justify-content: space-around; align-items: center;"> <div style="text-align: center;">  Too high         </div> <div style="text-align: center;">  Correct         </div> <div style="text-align: center;">  Too low         </div> </div>
	<p><b>The data presented by this equipment is intended as a source of navigation information.</b></p> <p>The prudent navigator never relies exclusively on any one source of navigation information, for safety of vessel and crew.</p>
	<p><b>The use of two transceivers with the same frequency will result in interference.</b></p> <p>When fitting more than one transceiver, ensure the frequencies are different.</p>

**Warning Label(s)**

Warning label(s) is(are) attached to the equipment. Do not remove the label(s). If a label is missing or damaged, contact a FURUNO agent or dealer about replacement.

 <b>CAUTION</b>		
 <b>Observe the following compass safe distances to prevent magnetic compass deviation:</b>		
	Standard Compass	Steering Compass
Display Unit FE-8010	0.75 m	0.50 m
Transceiver Unit FE-8020	1.50 m	0.95 m
Matching Box MB-502	0.80 m	0.50 m
Matching Box MB-504	0.65 m	0.40 m

**About the TFT LCD**

The TFT LCD is constructed using the latest LCD techniques and uses 99.99% of its pixels. The remaining 0.01% may drop out or blink, however this is not an indication of malfunction.

 <b>WARNING</b> 	
To avoid electrical shock, do not remove cover. No user-serviceable parts inside.	
 <b>警告</b> 	
<small>感電の恐れあり。 サービスマン以外の方はカバーを開けないで下さい。内部には高電圧部分が多くあり、万一さわると危険です。</small>	

Name: Warning Label 1  
Type: 86-003-1011-3  
Code No.: 100-236-233

# TABLE OF CONTENTS

<b>FOREWORD .....</b>	<b>v</b>
<b>SYSTEM CONFIGURATION .....</b>	<b>vii</b>
<b>1. OPERATION .....</b>	<b>1</b>
1.1 Controls.....	1
1.2 How to Turn the Power On/Off....	2
1.3 Panel and Key Brilliance .....	3
1.3.1 Day/Night Mode (Dimmer Mode: FE-800).....	3
1.3.2 Day/Dusk/Night Mode (Dimmer Mode: ECDIS).....	4
1.4 Display Modes and Screen Indications .....	5
1.4.1 NAV Mode .....	6
1.4.2 HISTORY Mode.....	7
1.4.3 OS DATA Mode .....	8
1.5 Menu Overview .....	9
1.6 How to Select a Range .....	10
1.6.1 How to enable/disable auto range.....	10
1.7 Gain.....	10
1.7.1 How to adjust the gain .....	10
1.7.2 Automatic Operation .....	11
1.7.3 How to offset the auto gain .....	11
1.8 Clutter.....	12
1.9 Interference .....	12
1.10 PICT Advance .....	13
1.11 How to Set the Depth Alarm.....	13
1.12 How to Use the Function Key....	14
1.13 How to Output to External Equipment.....	14
1.14 How to Choose a Transceiver...	15
1.15 How to Set the Depth Below Surface (DBS) .....	15
1.16 How to Set Draught.....	16
1.17 Logbook .....	17
1.18 How to Change the Unit of Measurement .....	18
1.19 How to Select the Displayed Course.....	18
1.20 How to Change the Colour Scheme .....	19
1.21 Dual Transducer Operations .....	19
1.21.1 How to switch between displayed transducers.....	19
1.21.2 How to change the displayed depth.....	19
1.21.3 How to adjust the dimmer presets .....	20
<b>2. SYSTEM MENU .....</b>	<b>21</b>
2.1 How to Set the Basic Range Scale....	21
2.2 How to Set Transducer Parameters .....	22
2.2.1 Bottom level.....	22
2.2.2 TVG level.....	23
2.2.3 Echo offset.....	23
2.3 How to Set TX Rate .....	23
2.4 How to Set Bottom Tail Display .....	24
2.5 How to Set Bottom Link RNG .....	24
2.6 How to Set the Speed of Sound.....	24
2.7 Alert Menu.....	25
2.7.1 Active alert list .....	25
2.7.2 How to display the alert log	26
2.7.3 Bottom lost.....	27
2.8 Alarms, Warnings and Cautions .....	28
2.8.1 Alert icons and their meanings .....	30
2.8.2 Responsibility transfer alert .....	31
2.8.3 Repeat of Warning alert.....	31
2.9 How to Set or Adjust the Time .....	32
2.9.1 External time.....	32
2.9.2 Internal time.....	33
2.10 Key Beeps.....	33
2.11 How to Set Up the FE-800 for Data Recording .....	34
2.12 How to Set Draught from External Equipment.....	34
2.13 How to Adjust the Dimmer from External Equipment.....	35
2.14 System Information .....	35
2.15 User Reset .....	35
<b>3. MAINTENANCE AND TROUBLESHOOTING.....</b>	<b>36</b>
3.1 Checklist .....	36
3.2 Cleaning the Display Unit.....	36
3.3 Transducer Maintenance .....	36
3.4 Fan and LCD Backlight Life Expectancy .....	36
3.5 Replacing the Fuse/Battery.....	37
3.6 Troubleshooting .....	37
<b>APPX. 1 MENU TREE.....</b>	<b>AP-1</b>
<b>APPX. 2 PARTS LOCATIONS.....</b>	<b>AP-4</b>
<b>APPX. 3 LIST OF TERMS AND ABBREVIATIONS .....</b>	<b>AP-5</b>
<b>APPX. 4 ALERT MESSAGES.....</b>	<b>AP-7</b>
<b>SPECIFICATIONS .....</b>	<b>SP-1</b>
<b>INDEX .....</b>	<b>IN-1</b>

# FOREWORD

---

## A Word to FE-800 Owners

Thank you for purchasing this navigational echo sounder. We are confident you will discover why FURUNO has become synonymous with quality and reliability.

Since 1948, FURUNO Electric Company has enjoyed an enviable reputation for innovative and dependable marine electronics equipment.

This dedication to excellence is furthered by our extensive global network of agents and dealers.

Please carefully read and follow the safety information and operating and maintenance instructions set forth in this manual before attempting to operate the equipment and conduct any maintenance. Your navigational echo sounder will perform to the utmost of its ability only if it is operated and maintained in accordance with the correct procedures.

This equipment is designed, produced and documented by FURUNO ELECTRIC CO., LTD., complying with ISO 9001 standards as certified by the Lloyd's Register of Quality Assurance System.

## Features

The FE-800 is a colour navigation echo sounder which operates with 50 or 200 kHz frequency. The FE-800 is comprised of a control unit, transceiver, matching box and transducer. Echoes are output on an 8.4-inch LCD screen.

The main features of the FE-800 are:

- Complies with the following regulations:  
ISO9875:2000, IEC60945 Ed.4, IEC61162-1 Ed.5, IEC61162-450 Ed.2, IEC62288 Ed.2., IEC 62923-1/2 Ed.1.
- Can display dual frequency (50 kHz/200 kHz) depth reading on one screen.
- Three display modes available:
  - NAV mode: Standard display showing depth readings.
  - OS DATA mode: Shows own ship location, time, COG/SOG alongside current depth readings.
  - HISTORY mode: Shows past readings in graph form alongside current depth readings.
- Can be connected to an external monitor (RD-20/RD-50) for remote display of readings.
- Compatible with Bridge Alert Management systems - IMO MSC.302(87)
- Can connect up to two transceivers, allowing dual on-screen display of echoes.
- Connecting the optional printer allows printing of echo data.
- Can save/replay up to 24 hours of depth reading history.
- Connecting a PC with the optional data recording software allows recording of echo data.

## **Program numbers**

<b>Unit</b>	<b>Program Number</b>
FE-8010	1251002-01.xx
FE-8020	1251003-01.xx

“xx” indicates minor version numbers.

## **CE/UKCA declaration**

With regards to CE/UKCA declarations, please refer to our website ([www.furuno.com](http://www.furuno.com)) for further information about RoHS conformity declarations.

## **Disclosure of Information about China RoHS**

With regards to China RoHS information for our products, please refer to our website ([www.furuno.com](http://www.furuno.com)).



# SYSTEM CONFIGURATION

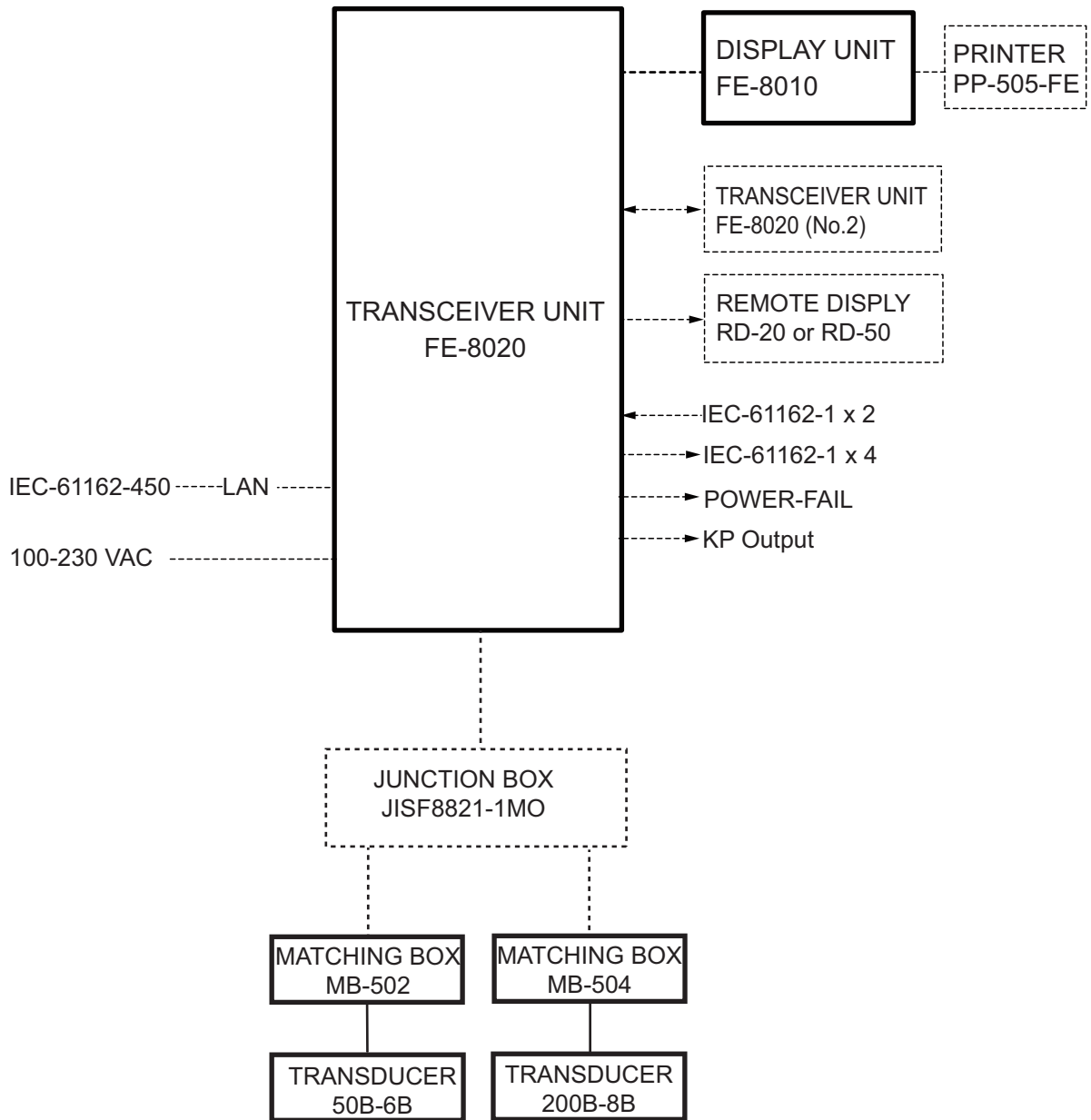

Equipment category	
Display unit	protected from weather
Transceiver unit	protected from weather

———— : Standard supply  
 ..... : Optional or local supply

# 1. OPERATION

## 1.1 Controls

All operations of the FE-800 are carried out with the controls on the front panel of the display unit. Some functions require a long key press, while others require a short key press.



### Removing the cover

While pressing the center with your thumbs as illustrated, pull the cover towards you to remove it.

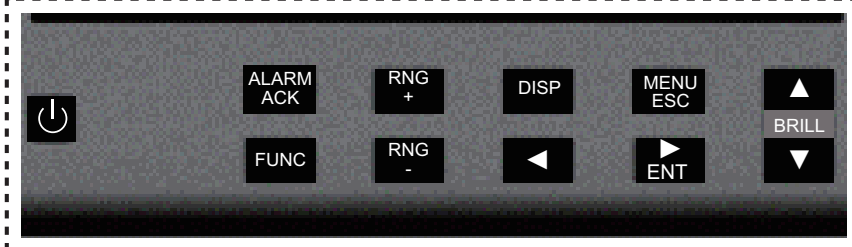
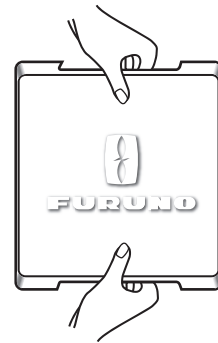



Key	Function
	Press to turn the FE-800 on/off.
<b>ALARM/ACK</b>	<ul style="list-style-type: none"> <li>• Short press to turn off the alert buzzer.</li> <li>• Long press to show the Alert List.</li> </ul>
<b>FUNC</b>	<ul style="list-style-type: none"> <li>• Long press to memorize menu functions.</li> <li>• Short press to recall memorized functions.</li> </ul>
<b>RNG +</b>	Increases depth range.
<b>RNG -</b>	Decreases depth range.
<b>DISP</b>	<ul style="list-style-type: none"> <li>• Cycles through display modes in the following order: (Nav → History → OS Data → Nav)</li> <li>• Returns to Main display from any location in the menus.</li> </ul>
<b>MENU/ ESC</b>	<ul style="list-style-type: none"> <li>• Displays/closes the menu.</li> <li>• Returns one level in the menu tree (unless on first level).</li> </ul>
 and  <b>ENT</b>	<ul style="list-style-type: none"> <li>• Adjusts key brilliance.</li> <li>• Menu screens - Moves up/down levels in the menu tree.</li> <li>• History - Moves the cursor location in the history mini-window.</li> <li>• Logbook - Changes the displayed page.</li> <li>• Mini-windows (GAIN, etc.) - Switches settings (EG: FORE/AFT settings).</li> </ul>
<b>BRILL</b>  	<ul style="list-style-type: none"> <li>• Opens [Brilliance Setting] pop-up window/Adjust panel brilliance.</li> <li>• Select menu items in menu window.</li> <li>• Change settings in current pop-up window.</li> </ul>

## 1.2 How to Turn the Power On/Off

**Note 1:** Make sure the unit is connected correctly to each transceiver.

**Note 2:** After turning the unit off, wait at least 5 seconds before you turn the power on again.

Press the  button to turn the unit on. With the power on, press the  button again to turn the unit off.

On startup, the unit displays a splash screen for approximately ten seconds, then begins a self-test. The self-test checks the logic circuits, battery status and displays the program version currently in use.



*Splash screen*

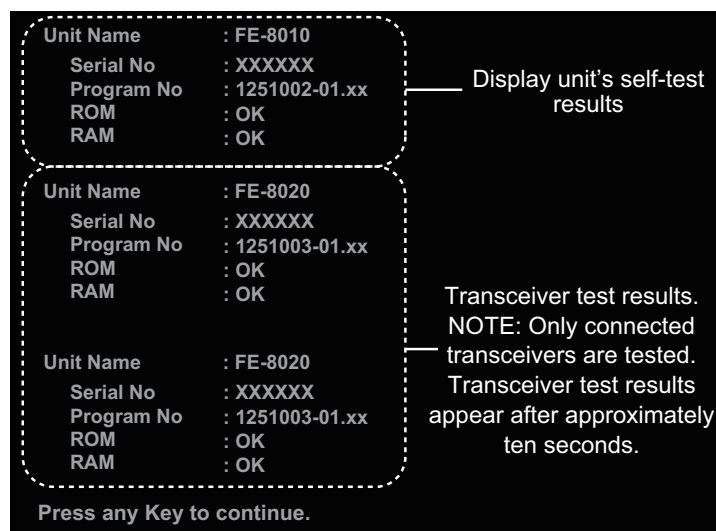

*Self-test results*

After the self-test completes, the mode used before the FE-800 was turned off is activated. You can now change modes freely (See section 1.4.)

**Note:** If any errors occur during the self-test process, the self-test stops the startup procedure. Contact your local Furuno dealer for service.

## 1.3 Panel and Key Brilliance

Both panel and key brilliance can be adjusted from the main screen using the following procedure:

1. Press ▲ or ▼ on the **BRILL** pad to open the Brilliance pop-up window.

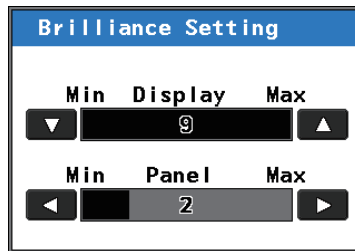

2. Press ▲ or ▼ to adjust panel brilliance.
3. Press ◀ or ▶ to adjust key brilliance.
4. Press the **MENU/ESC** key to close the pop-up window.

Brilliance settings for Day or Night mode are stored separately.

When changing modes, the last-used setting is restored.

Panel brilliance, Key brilliance and Colour scheme mode can be changed for the suitable location in the [Day/(Dusk)\*1/Night].

\*1: Dusk setting is available when Dimmer Mode\*2 is ECDIS.

\*2: According to the Dimmer Mode setting, it is selectable that panel brilliance change from the external equipment is available or not. Refer to the section 2.13.

### 1.3.1 Day/Night Mode (Dimmer Mode: FE-800)

The FE-800 has Day and Night display settings to allow better screen visibility. To switch between modes, do the following:

1. Press the **MENU/ESC** key to open the Main menu.
2. Select [Day/Night], then press the **ENT** key.

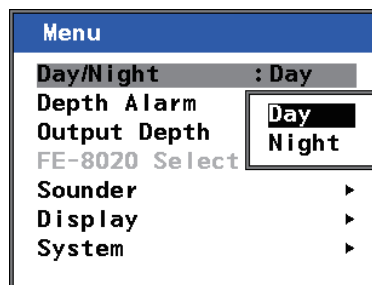

3. Select [Day] or [Night] as appropriate, then press the **ENT** key.
4. Press the **MENU/ESC** key once to close the menu.

The default settings for Day and Night modes are shown in the table below.

Mode	Panel Brilliance	Key Brilliance
Day	9	2
Night	2	2

### 1.3.2 Day/Dusk/Night Mode (Dimmer Mode: ECDIS)

In ECDIS dimmer mode, Day, Dusk and Night settings are available, to allow better screen visibility. To switch between modes, do the following:

1. Press the **MENU/ESC** key to open the Main menu.
2. Select [Day/Dusk/Night], then press the **ENT** key.

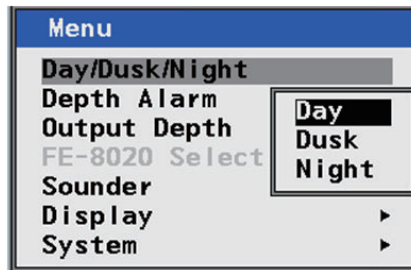

3. Select [Day], [Dusk] or [Night] as appropriate, then press the **ENT** key.
4. Press the **MENU/ESC** key once to close the menu.

The default setting for Day, Dusk and Night modes are shown in the table as below.

Mode	Panel Brilliance	Key Brilliance	Colour Scheme
Day	9	2	Amber
Dusk	5	2	Amber
Night	2	2	Amber

In case of the brightness-related change from the external equipment during the [Brilliance Setting] display, the indication on the screen is changed. But, the value of the [Brilliance Setting] window is not changed. Close [Brilliance Setting] window once, and the value is updated when displaying it again.

1. OPERATION

# 1.4 Display Modes and Screen Indications

The FE-800 has 3 main display modes: NAV, HISTORY, OS DATA.

The display modes are set in a cycle pattern, and each press of the **DISP** key changes the selected mode, in the sequence shown below.





**Note 1:** OS DATA mode requires external EPFS data (EG:GPS). If [Time Adjust] in the [Service] menu is set to [Internal] when initial settings are made, the OS DATA screen is unavailable. To change the [Time Adjust] settings, consult a FURUNO technician.

**Note 2:** The main display shows output from both transducers if two are connected. If only one is connected, the display shows only the output from the connected transducer. The menu display may change slightly for single transducer configurations.

For brevity, this manual uses a two transducer output display for all explanations.

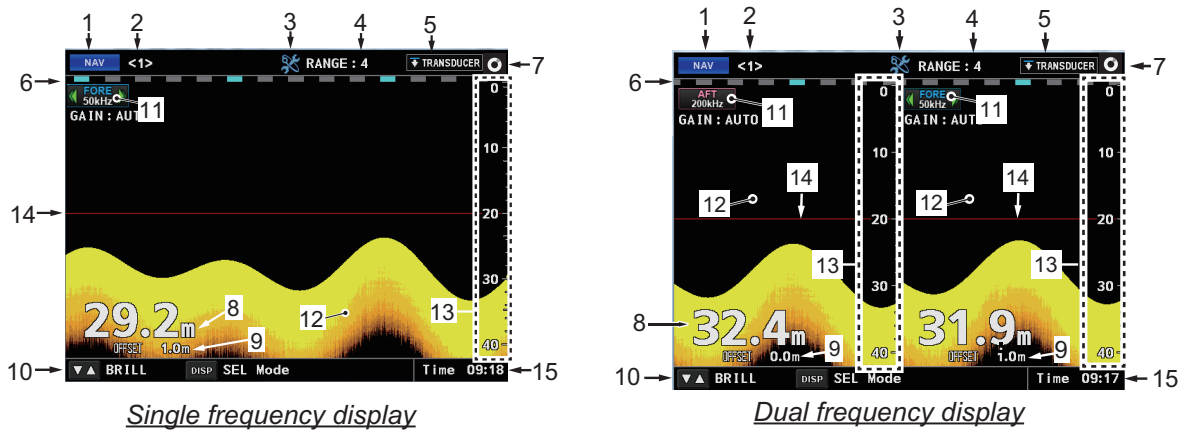
An example of the difference between single and dual frequency displays and their respective marks and indications is shown below.



No.	Name	Description
1	Mode indicator	Shows current display mode (NAV, NAV + HISTORY or NAV + OS DATA).
2	Transceiver no.	Shows the currently selected transceiver.
3	Remote maintenance icon	Indicates that the remote access function from external equipment is activated. This icon is shown when [Management Profile] is set to [ON] (at installation).
4	Range setting	Shows the currently selected range setting.
5	Reading indicator	Shows the currently selected reference point for depth readings. (TRANSDUCER, KEEL OR SURFACE.)
6	Time scale	Shows the time scale for displayed readings. One square is equal to 1 minute of readings. The distance from one blue square to the next is equal to ten minutes of readings. When FE-8020 No.2 is selected, the upper half of the time scale is displayed as a solid green line.
7	System status indicator 	Shows unit is functioning normally. Stops moving when unit is malfunctioning.
8	Depth	Shows current depth and selected depth unit. <b>Note:</b> Depth is calculated from the location displayed at "Reading indicator" (#5 in the above figures). To change this setting, see section 1.5.
9	Depth offset	Shows the distance, from depth reference point to the keel, for respective transducer. <b>Note:</b> Offset is calculated from the depth reference point (see section 1.5). This item is hidden when the reference point is set to [KEEL].

No.	Name	Description
10	Alarm message or menu description	Shows active alarms or a brief description of the selected menu item. <b>Note:</b> Alarm messages take priority over menu descriptions.
11	Transducer	Shows the location of the transducer and output signal.
12	Sounding echo	Shows the reflected echo.
13	Range indicator	Shows depth range. Changes with range scale.
14	Depth Alarm line	Indicates the depth setting for the depth alarm. (Displayed in red).
15	Time	Indicates time and time setting (UTC, Local, Time).

### 1.4.1 NAV Mode

This is the default mode for the FE-800. The screen shows depth and echo from FORE and AFT positions.

The default display order of the echo readings is AFT - FORE.

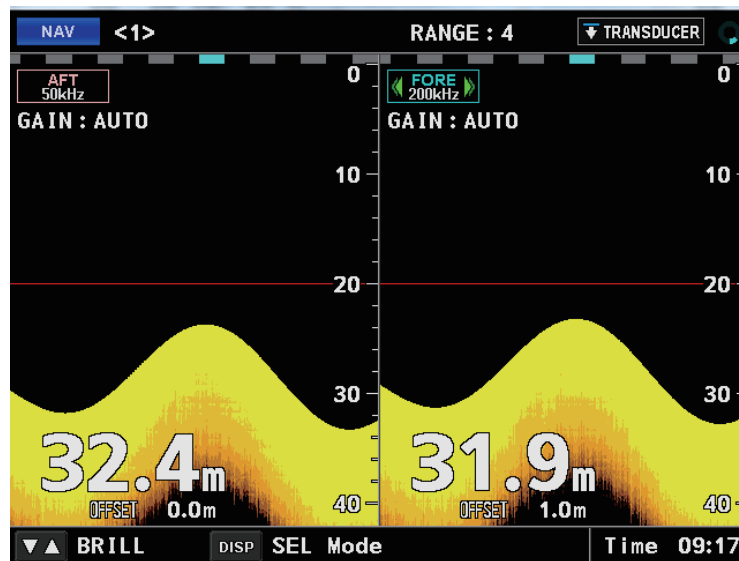

1. OPERATION

**1.4.2 HISTORY Mode**

This mode provides a mix of Contour and Strata echo readings taken. The amount of data stored in the HISTORY log depends on the interval setting. The table below shows the differences in amount of data that can be stored.

Interval setting	Amount of data stored
2 min	24 hours
1 min	12 hours
5 sec	1 hour

Previous echo readings can be accessed by using ◀ or ▶ to move the cursor.

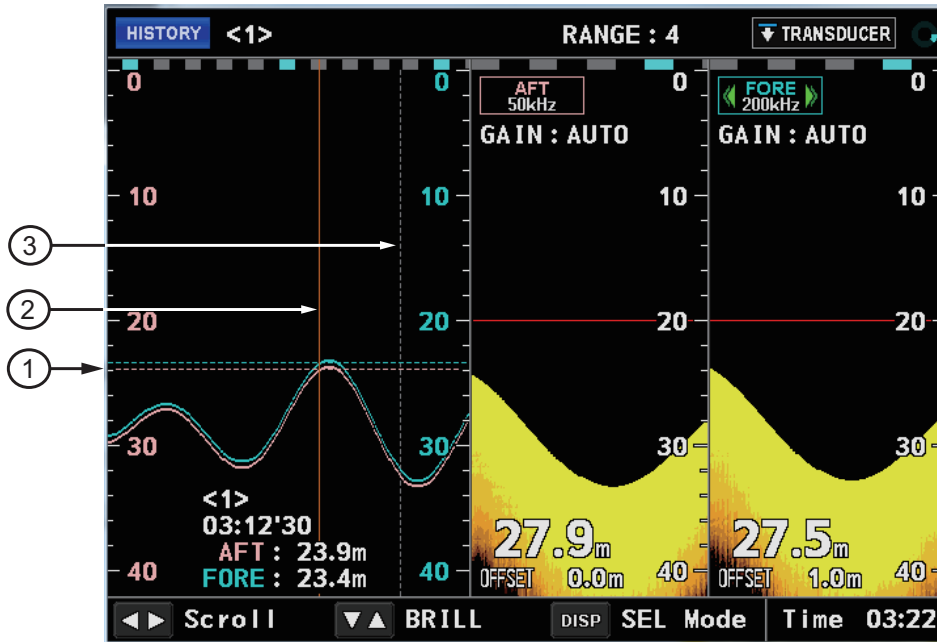

Number	Description
1	FORE/AFT depth history.
2	Time (location) in sounding depth history. Move this indicator using ◀ or ▶. FORE/AFT history readings are displayed at the bottom of this screen.
3	Change indicator. This line appears in the case of any de-synchronization between the FE-800 and connected sensors or units.



### 1.4.3 OS DATA Mode

This mode shows Own Ship Data (OS DATA), and is only available if the [Time Adjust] setting in the [Service Menu] is set to [External].

To change the [Time Adjust] settings in the [Service Menu], consult a FURUNO technician.

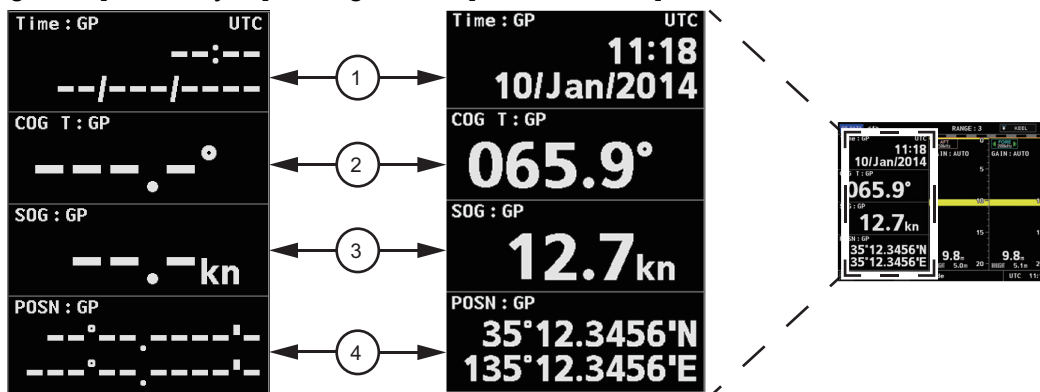

The OS DATA mode requires a connected EPFS device, such as GPS. If there is no device connected, or connection is interrupted, the OS DATA is displayed as shown in the above left figure. The left side of the display shows the OS DATA, the right side of the display shows the current echo readings.

Number	Description
1	Date and Time as received by the EPFS device.
2	COG (Course Over the Ground) as calculated by the EPFS device.
3	SOG (Speed Over the Ground) as calculated by the EPFS device.
4	POSN (Position) as calculated by the EPFS device.

EPFS devices are often referred to as “talkers”. Below is a list of talker types, and their respective display names, which can be used with the FE-800.

Displayed talker name	Description
DE	Decca Navigator
GA	Galileo positioning system
GL	GLONASS positioning system
GN	Global navigation satellite system (GNSS)
GP	Global positioning system (GPS)
II	Integrated instrumentation
IN	Integrated navigation
LA	Loran A
LC	Loran C

## 1.5 Menu Overview

1. Press the **MENU/ESC** key to open the Main menu.

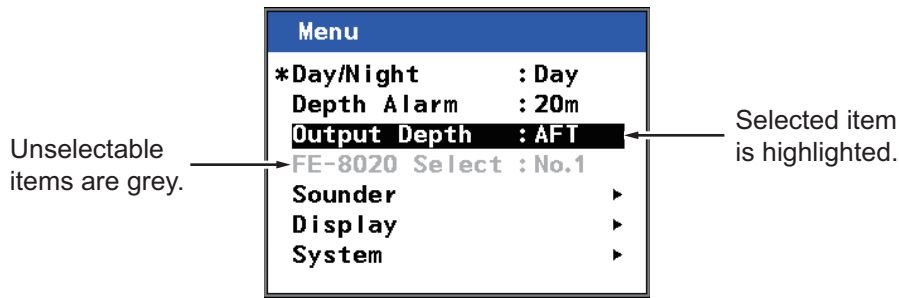

2. Use the **▲** or **▼** key to navigate the menu. The item currently selected is highlighted.
3. To choose a menu item, press the **▶ ENT** key.  
Depending on which item is selected, a new menu, a setting window or a setting box is displayed.

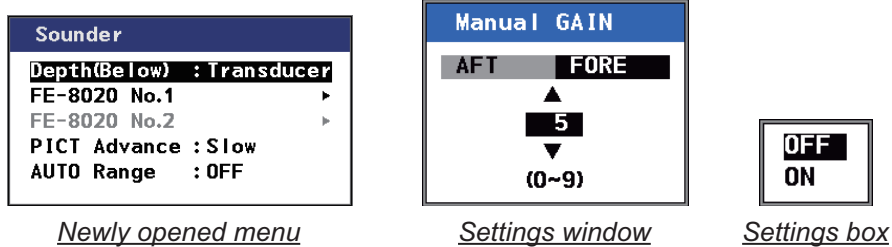

4. Use the **▲** or **▼** key to navigate the menu or adjust settings as required.
5. Press the **▶ ENT** key to open the selected item, or to apply the setting changes.  
To return to the previous menu, or to abandon changes, press **◀** or the **MENU/ESC** key.
6. Press the **DISP** key once, or press the **MENU/ESC** key several times to close the menus.

**Note 1:** If [FE-8020 No.2] is not enabled in the [Service Menu], the following menu items are grey and not selectable:

- Main menu → [FE-8020 Select]
- [Sounder] menu → [FE-8020 No.2]
- [System] menu → [Parameters] → [FE-8020 No.2]
- [System] menu → [Information] → [FE-8020 No.2]

To enable [FE-8020 No.2], consult a FURUNO technician.

**Note 2:** For brevity, all further references to the **▶ ENT** key are written as “**ENT** key”.

If the display settings are set to FORE - AFT at installation, some pop-up menu layouts will change according to the FORE - AFT or AFT - FORE display order.

The example below shows both the default, AFT - FORE, and the custom display order of FORE - AFT.

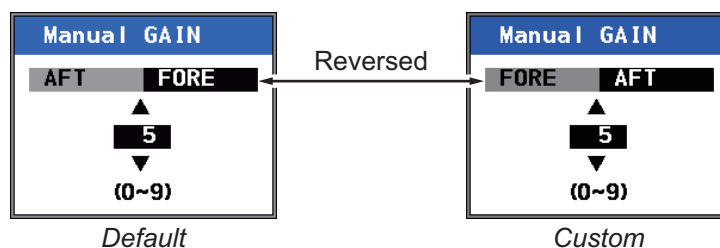

For the sake of brevity, all explanations and images in this manual use the default.

## 1.6 How to Select a Range

The range can be set either manually or automatically. In the auto mode, the range will self-adjust to provide as clear as possible an image. The auto mode is cancelled when the range is manually adjusted.

There are eight basic ranges available.

Press **RNG+** or **RNG-** to change the range.

In cases where the depth goes outside the display area, adjust the range scale until the seabed appears near the center of the screen. (See section 2.1.)

### 1.6.1 How to enable/disable auto range

1. Press the **MENU/ESC** key to open the Main menu.
2. Select [Sounder] using ▲ or ▼, then press the **ENT** key.
3. Select [Auto Range] using ▲ or ▼, then press the **ENT** key.
4. Select [ON] or [OFF] as appropriate, then press the **ENT** key to apply the setting.
5. Press the **MENU/ESC** key twice to close the menu.

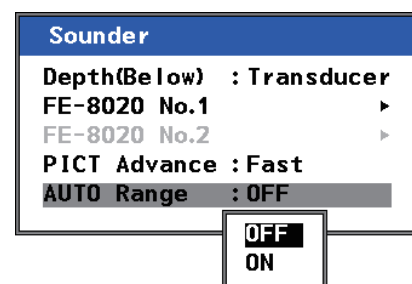

## 1.7 Gain

**Note:** To manually adjust the gain, you must first turn [AUTO GAIN] off. The figures shown in this section are of a dual transducer configuration. Single transducer configuration pop-up menus will change slightly.

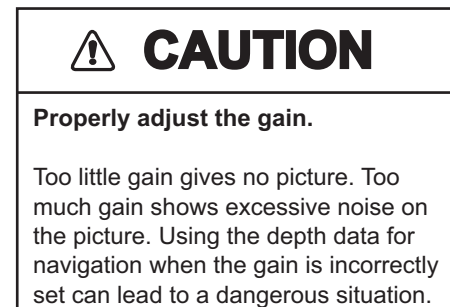

### 1.7.1 How to adjust the gain

1. Press the **MENU/ESC** key to open the Main menu.
2. Select [Sounder] using ▲ or ▼, then press the **ENT** key.
3. Select the appropriate transceiver ([FE-8020 No.1] or [FE-8020 No.2]) using ▲ or ▼, then press the **ENT** key.
4. Select [Manual GAIN] using ▲ or ▼, then press the **ENT** key. This will open a pop-up window.
5. If using a single transducer configuration, skip to step 7. For dual transducer configuration go to the next step.
6. Select [AFT] using ◀ or ▶.  
The available settings are [0] to [9].
7. Adjust the gain using ▲ or ▼, then press the **ENT** key to select [FORE].
8. Adjust the gain for [FORE] using ▲ or ▼, then press the **ENT** key. The available settings are [0] to [9].
9. Press the **MENU/ESC** key three times to close the menu.

The FORE/AFT bar is absent in single transducer configurations.

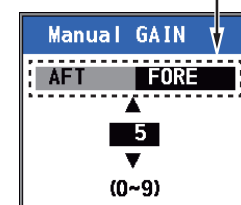

## 1. OPERATION

### 1.7.2 Automatic Operation

The gain and clutter (low level noise) adjustments can be done automatically.

#### How to turn automatic operation on or off

1. Press the **MENU/ESC** key to open the Main menu.
2. Select [Sounder] using **▲** or **▼**, then press the **ENT** key.
3. Select the appropriate transceiver ([FE-8020 No.1] or [FE-8020 No.2]) using **▲** or **▼**, then press the **ENT** key.
4. Select [AUTO GAIN] using **▲** or **▼**, then press the **ENT** key. This will open a pop-up window.
5. Select [ON] or [OFF] as appropriate, using **▲** or **▼**, then press the **ENT** key to apply the setting.
6. Press the **MENU/ESC** key three times to close the menu.

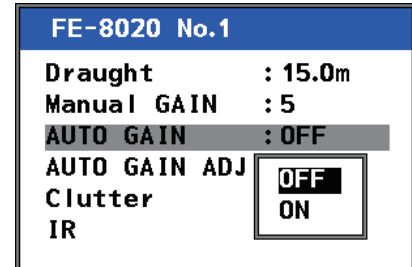

### 1.7.3 How to offset the auto gain

1. Press the **MENU/ESC** key to open the Main menu.
2. Select [Sounder] using **▲** or **▼**, then press the **ENT** key.
3. Select the transceiver ([FE-8020 No.1] or [FE-8020 No.2]) as appropriate using **▲** or **▼**, then press the **ENT** key.
4. Select [AUTO GAIN ADJ], then press the **ENT** key. This will open a pop-up window.
5. If using a single transducer configuration, skip to step 7. For dual transducer configuration go to the next step.
6. Select [AFT] using **◀** or **▶**. The available range is [-10] to [+10].
7. Select the desired setting using **▲** or **▼**, then press the **ENT** key to select [FORE].
8. Adjust the setting for [FORE] using **▲** or **▼**, then press the **ENT** key to apply the settings and close the pop-up window. The available range is [-10] to [+10].
9. Press the **MENU/ESC** key three times to close the menu.

The FORE/AFT bar is absent in single transducer configurations.

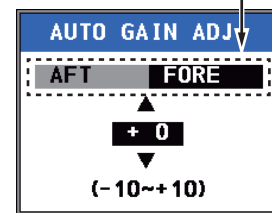

## 1.8 Clutter

Low level noise can cause your display to look “cluttered” with unnecessary dots. These are caused mainly by dirty water or noise. This kind of noise can be suppressed by adjusting the clutter.

**Note:** To manually adjust the clutter, you must first turn [AUTO GAIN] off.

1. Press the **MENU/ESC** key to open the Main menu.
2. Select [Sounder] using ▲ or ▼, then press the **ENT** key.
3. Select the transceiver ([FE-8020 No.1] or [FE-8020 No.2]) as appropriate using ▲ or ▼, then press the **ENT** key.
4. Select [Clutter] using ▲ or ▼, then press the **ENT** key. This will open a pop-up window.
5. If using a single transducer configuration, skip to step 7. For dual transducer configuration go to the next step.
6. Select [AFT] using ◀ or ▶. The available settings are [0] to [7].
7. Adjust the Clutter as desired, using ▲ or ▼, then press the **ENT** to select [FORE].
8. Adjust [FORE] clutter using ▲ or ▼, then press the **ENT** key to apply the settings and close the pop-up window. The available settings are [0] to [7].
9. Press the **MENU/ESC** key three times to close the menu.

The FORE/AFT bar is absent in single transducer configurations.

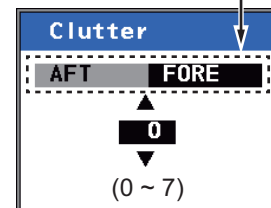

## 1.9 Interference

Interference from other acoustic equipment operating nearby or other electronic equipment on your vessel may show on your display. There are three levels of interference suppression, [IR1], [IR2] and [IR3]. The higher the number, the greater the degree of suppression. The default setting is [OFF].

1. Press the **MENU/ESC** key to open the Main menu.
2. Select [Sounder] using ▲ or ▼, then press the **ENT** key.
3. Select the transceiver ([FE-8020 No.1] or [FE-8020 No.2]) as appropriate using ▲ or ▼, then press the **ENT** key.
4. Select [IR] using ▲ or ▼, then press the **ENT** key. This will open a pop-up window.
5. Adjust the interference suppression as desired, using ▲ or ▼, then press the **ENT** key to apply the settings and close the pop-up window. The available settings are [IR1], [IR2], [IR3] and [OFF].
6. Press the **MENU/ESC** key three times to close the menu.

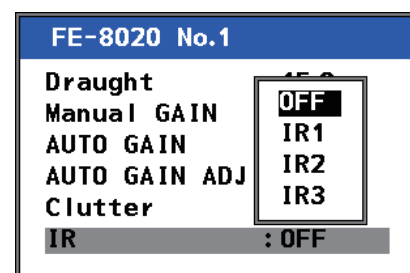

## 1. OPERATION

### 1.10 PICT Advance

The picture advance menu allows you determine the speed at which the vertical scan lines run across the screen.

1. Press the **MENU/ESC** key to open the Main menu.
2. Select [Sounder] using ▲ or ▼, then press the **ENT** key.
3. Select [PICT Advance] using ▲ or ▼, then press the **ENT** key. This will open a pop-up window.

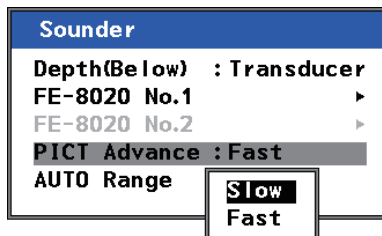

4. Select [FAST] or [SLOW] as appropriate, using ▲ or ▼, then press the **ENT** key.  
[FAST] picture advance expands the echo sideways across the screen. This is useful when studying a rough bottom closely.  
[SLOW] picture advance compresses the echo allowing for close inspection when the bottom is smooth.
5. Press the **MENU/ESC** key twice to close the menu.

### 1.11 How to Set the Depth Alarm

The depth alarm sounds when the seabed is shallower than the depth setting. The default setting is 20 meters.

**Note:** The depth setting distance is measured from the face of the transducer.

The depth can be adjusted by following the procedure below:

1. Press the **MENU/ESC** key to open the Main menu.
2. Select [Depth Alarm] using ▲ or ▼, then press the **ENT** key. This will open a pop-up window.
3. Choose the depth at which you wish the alarm to activate, using ▲ or ▼, then press the **ENT** key to apply the settings and close the pop-up window.  
The available range is 0 to 2400m.
4. Press the **MENU/ESC** key once to close the menu.

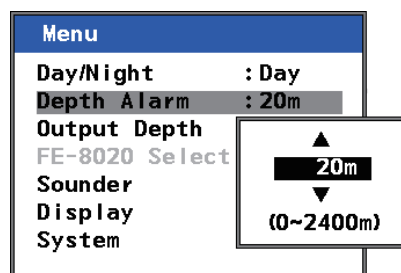

#### **How to acknowledge the alarm and silence the alarm buzzer**

You can acknowledge the alarm, and silence the buzzer, by pressing the **ALARM/ACK** (Alarm Acknowledge) key.

## 1.12 How to Use the Function Key

The function key can store and recall a preset location in the menu. You can recall the function by pressing the **FUNC** key.

### To store a function

1. Navigate the menu to the function you wish to store.
2. Press and hold the **FUNC** key to store the menu function. A small asterisk "\*" will appear next to the menu item when it is stored.

In the example below, [Manual GAIN] is stored to the **FUNC** key.

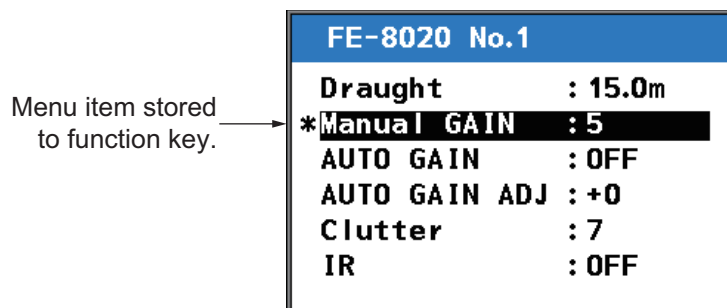

3. Release the **FUNC** key after the asterisk "\*" appears.
4. Press the **DISP** key to return to the main display.

## 1.13 How to Output to External Equipment

The FE-800 can output depth information from one transceiver to external equipment, such as ECDIS. To select the transceiver which will output to the external equipment, do the following:

1. Press the **MENU/ESC** key to open the Main menu.
2. Select [Output Depth] using ▲ or ▼, then press the **ENT** key.
3. Select [FORE] or [AFT] as appropriate, then press the **ENT** key.

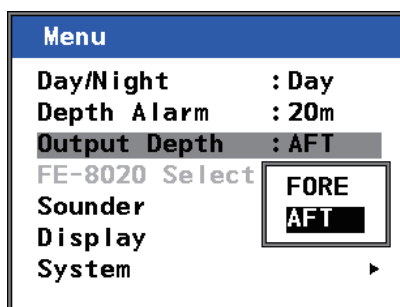

The selected transceiver is highlighted as shown in the figure below.



Transceiver selected for external output is highlighted with green arrows.

4. Press the **MENU/ESC** key once to close the menu.

## 1.14 How to Choose a Transceiver

If your FE-800 is connected to two transceivers, you can switch between the transceivers using the procedure below.

**Note:** If [FE-8020 No.2] is not enabled in the [Service Menu], this menu is not selectable. To enable [FE-8020 No.2], consult a FURUNO technician.

1. Press the **MENU/ESC** key to open the Main menu.
2. Select [FE-8020 Select] using **▲** or **▼**, then press the **ENT** key. This will open a pop-up window.
3. Select the appropriate transceiver using **▲** or **▼**, then press the **ENT** key to apply the settings and close the pop-up window. The available options are [No.1] or [No.2]. The message "Changing settings..." is displayed while the FE-800 obtains data from the transceiver. When the message disappears, the switch between transceivers is complete.
4. Press the **MENU/ESC** key once to close the menu.

## 1.15 How to Set the Depth Below Surface (DBS)

The depth reading can be referenced from one of three points.

Reference point	Description
Transducer	Depth from transducer to seabed (requires transducer "below waterline" measurement.)
Surface	Depth from surface to seabed (requires Draught input, see section 1.16.)
Keel	Depth from keel to seabed (requires keel depth setting. Consult your local FURUNO dealer.)

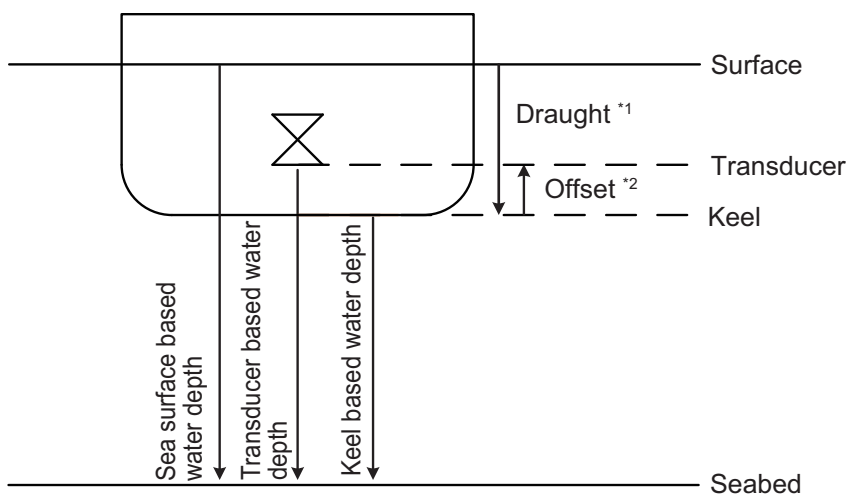

\*1: Set the draught on [Draught] menu.

\*2: Set the offset for transducer on [KEEL] menu (service menu).

To choose which setting to use, do the following:

1. Press the **MENU/ESC** key to open the Main menu.
2. Select [Sounder] using **▲** or **▼**, then press the **ENT** key.



3. Select [DEPTH(BELOW)] using ▲ or ▼, then press the **ENT** key. This will open a pop-up.

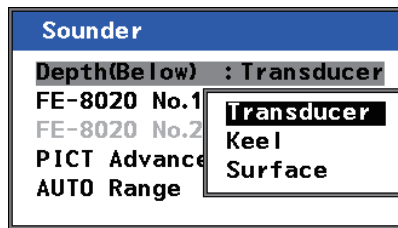

4. Select the location to take the depth reading from, then press **ENT** to apply the settings and close the pop-up window. The available options are [Transducer], [Surface] and [Keel].
5. Press the **MENU/ESC** key twice to close the menu.

## 1.16 How to Set Draught

Draught is the calculated distance from the keel to the water surface. Draught can be set in two locations, [FORE] and [AFT], if your vessel has transducers at both of these locations. If your vessel only has one transducer, the draught is set at the transducer location only.

To set the draught for your vessel, do the following:

1. Press the **MENU/ESC** key to open the Main menu.
2. Select [Sounder] using ▲ or ▼, then press the **ENT** key.
3. Select the appropriate transceiver to set ([FE-8020 No.1] or [FE-8020 No.2]), then press the **ENT** key.
4. Select [Draught], then press the **ENT** key. This will open a pop-up window.
5. If using a single transducer configuration, skip to step 8. For dual transducer configuration go to the next step.
6. Select [AFT] using ◀ or ▶.
7. Choose the draught depth using ▲ or ▼, then press the **ENT** to select [FORE].
8. Adjust [FORE] draught using ▲ or ▼, then press the **ENT** key to apply the settings and close the pop-up window. Available range differs according to the setting of keel in [Service Menu]. When the setting of keel is set as 0.0 m, the available range is 0.0 m to 30.0 m. When the setting of keel is set as 10.0 m, the available range is 10.0 m to 40.0 m.
9. Press the **MENU/ESC** key three times to close the menu.

The FORE/AFT bar is absent in single transducer configurations.

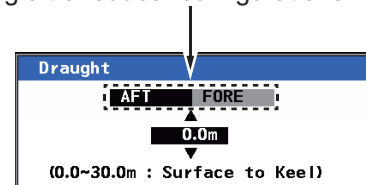

### Draught between the External Equipment

When [EXT Setting] in the [System] menu is set to [ON], the draft value is taken from external equipment. When [EXT Setting] is set to [OFF], the draught value is as set in the above procedure.

1. OPERATION

## 1.17 Logbook

The FE-800 stores log data at five second intervals, with a maximum log period of 24 hours.

Once the maximum number of entries is reached, the oldest entry is deleted to make room for the youngest entry.

The logbook is capable of displaying data a maximum of 720 log entries, depending on the display interval.

Display interval	Time to display	Time to record
5 seconds	1 hour	24 hours
1 minute	12 hours	24 hours
2 minutes	24 hours	24 hours

### How to display the logbook

To display the logbook, do the following:

1. Press the **MENU/ESC** key to open the Main menu.
2. Select [DISPLAY] using ▲ or ▼, then press the **ENT** key.
3. Select [LOGBOOK] using ▲ or ▼, then press the **ENT** key.
4. Press ► or ◀ to change the page currently displayed.
5. Press the **DISP** key to close the logbook.

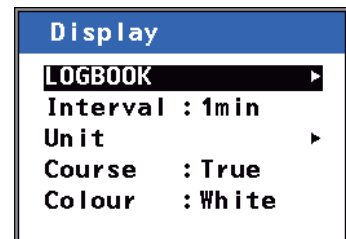

### How to change the logging interval

The logging interval for each entry can be adjusted in the menu by doing the following:

1. Press the **MENU/ESC** key to open the Main menu.
2. Select [Display] using ▲ or ▼, then press the **ENT** key.
3. Select [Interval] using ▲ or ▼ then press the **ENT** key. The Interval settings pop-up window will open.
4. Choose the appropriate interval (5 s - 1 hour max., 1 min - 12 hours max., 2 min - 24 hours max.) using ▲ or ▼, then press the **ENT** key to apply the settings and close the pop-up window.
5. Press the **MENU/ESC** key twice to close the menu.

**Note:** Changing the interval will change the data available to be displayed in the LOGBOOK.



Number	Description
1	Currently displayed time setting. [UTC]: Coordinated Universal Time. [Local]: Time with UTC difference calculated. [Time]: Unit's internal clock time.
2	When the external time source is unavailable, a "*" appears to the left of the time. If [Time Adjust ] is set to Internal, the color changes according to the setting selected at section 1.20.
3	Currently viewed page. Data is listed in order from newest to oldest.

## 1.18 How to Change the Unit of Measurement

You can change the displayed unit of measurement for depth and speed using the following procedure.

1. Press the **MENU/ESC** key to open the Main menu.
2. Select [Display] using ▲ or ▼, then press the **ENT** key.
3. Select [Unit] using ▲ or ▼, then press the **ENT** key. This will open the [Unit] pop-up window.
4. Select the [Depth] or [Speed] using ▲ or ▼, then press **ENT** to open the settings pop-up window. The available options are shown in the table below.

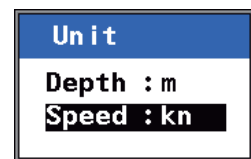

Item	Unit
Depth	m (meters)
	ft (feet)
Speed	kn (knots)
	MPH (Miles Per Hour)
	km/h (Kilometers Per Hour)

5. Press the **MENU/ESC** key three times to close the menu.

## 1.19 How to Select the Displayed Course

You can select a course reference, true or magnetic.

1. Press the **MENU/ESC** key to open the Main menu.
2. Select [Display] using ▲ or ▼, then press the **ENT** key.
3. Select [Course] using ▲ or ▼, then press the **ENT** key. This will open a pop-up window.
4. Select the course display using ▲ or ▼, then press **ENT** to apply the setting. The available options are [True] and [Magnetic].
5. Press the **MENU/ESC** key twice to close the menu.



1. OPERATION

## 1.20 How to Change the Colour Scheme

You can change the colour scheme of the display as follows:

1. Press the **MENU/ESC** key to open the Main menu.
2. Select [Display] using ▲ or ▼, then press the **ENT** key.
3. Select [Colour] using ▲ or ▼, then press the **ENT** key. This will open a pop-up window.
4. Select the colour scheme using ▲ or ▼, then press **ENT** to apply the setting and close the pop-up window. The available options are shown in the figure to the right.

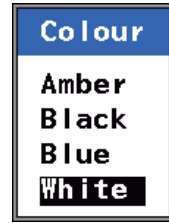

Colour scheme	Background Colour	Text Colour
Amber	Black	White
Black	Black	White
Blue	Blue	White
White	White	Black

5. Press the **MENU/ESC** key twice to close the menu.

## 1.21 Dual Transducer Operations

### 1.21.1 How to switch between displayed transducers

When there are two transducers connected, you may change the manner in which the echoes are displayed on-screen.

1. Press the **MENU/ESC** key to open the Main menu.
2. Select [Display] using ▲ or ▼, then press the **ENT** key.
3. Select [Echo] using ▲ or ▼, then press the **ENT** key. The pop-up window shown to the right appears.
4. Select [FORE], [AFT] or [DUAL] as appropriate.

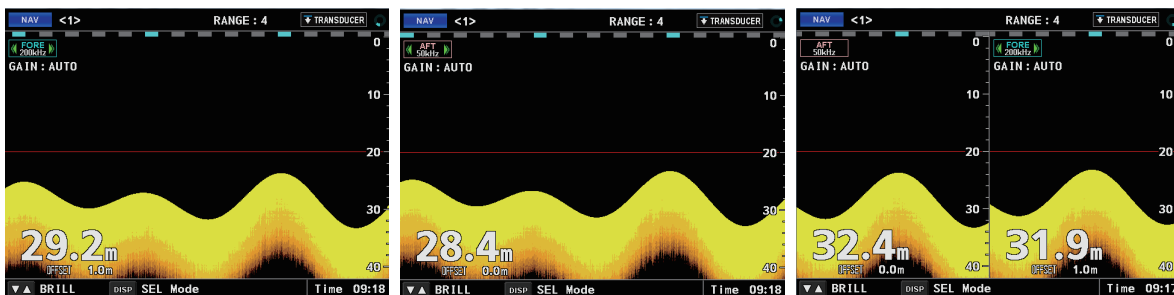

FORE

AFT

DUAL

5. Press the **DISP** key to close the menus.

### 1.21.2 How to change the displayed depth

When there are two transducers connected and the transducer display setting is [FORE] or [AFT] (see section 1.21.1), you may change the transducer used to display depth information.

**Note 1:** When the displayed transducer setting is set to [DUAL], this menu function is not available.

**Note 2:** When the transducer selected for echo display output and depth display differ, a pop-up message similar to the one shown to the right is displayed. To use the same transducer for information displayed, match the settings for [Output Depth] on the Main menu with the setting selected at section 1.21.1.

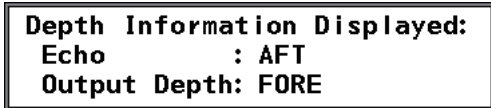

1. Press the **MENU/ESC** key to open the Main menu.
2. Select [Display] using **▲** or **▼**, then press the **ENT** key.
3. Select [Depth] using **▲** or **▼**, then press the **ENT** key. The pop-up window shown to the right appears.
4. Select [SINGLE] or [DUAL] as appropriate. When [DUAL] is selected, the secondary depth reading is displayed in a box at the bottom of the display.

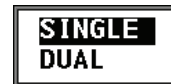

Secondary depth reading

5. Press the **DISP** key to close the menus.

### 1.21.3 How to adjust the dimmer presets

You can change the presets for background color and key and panel brilliance when [Dimmer Mode] in the [System] menu is set to [ECDIS]. These preset are also applied when Day/Dusk/Night is changed from external equipment.

1. Press the **MENU/ESC** key to open the Main menu.
2. Select [Display] using **▲** or **▼**, then press the **ENT** key.
3. Select [Dimmer Preset] using **▲** or **▼**, then press the **ENT** key.

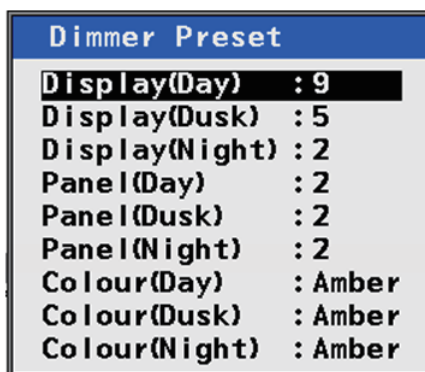

4. Select the item as appropriate using **▶**, then press the **ENT** key. Press **▲** or **▼** to select the desired setting, then press the **ENT** key.

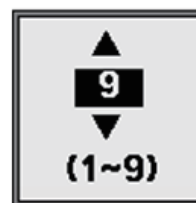

5. Press the **DISP** key to close the menus.



## 2. SYSTEM MENU

The [System Menu] should be preset at installation. Normally, there is no need to access this menu.

**Note:** The echo display will be cleared when the [System Menu] is opened.

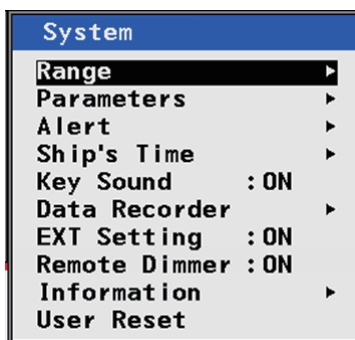

### 2.1 How to Set the Basic Range Scale

Use the table below for reference when changing the range scale settings. Depending on your configuration, some options may not be available.

Range scale setting	Range	Default
BASIC RANGE1	5 to (BR2-1)	5 m
BASIC RANGE2	(BR1+1) to 19	10 m
BASIC RANGE3	20	20 m
BASIC RANGE4	21 to (BR5-1)	40 m
BASIC RANGE5	(BR4+1) to 199	100 m
BASIC RANGE6	200	200 m
BASIC RANGE7	201 to (BR8-1)	400 m
BASIC RANGE8	(BR7+1) to 2400	800 m

1. Press the **MENU/ESC** key to open the Main menu.
2. Select [System] using **▲** or **▼**, then press the **ENT** key.
3. Select [Range] using **▲** or **▼**, then press the **ENT** key. This will open a pop-up window.

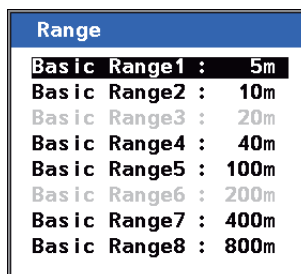

4. Select the basic range scale using **▲** or **▼**, then press the **ENT** key. This will open a pop-up window.
5. Adjust the range, if required, using **▲** or **▼**, then press the **ENT** key to apply the setting and close the pop-up window.  
To keep the default setting, press the **MENU/ESC** key or **◀**.
6. Press the **MENU/ESC** key three times to close the menu.

## 2.2 How to Set Transducer Parameters

1. Press the **MENU/ESC** key to open the Main menu.
2. Select [System] using ▲ or ▼, then press the **ENT** key.
3. Select [Parameters] using ▲ or ▼, then press the **ENT** key.

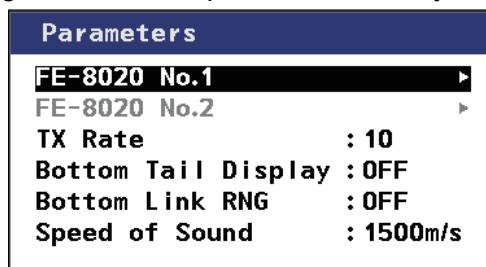

4. Select [FE-8020 No. 1] or [FE-8020 No. 2] as appropriate using ▲ or ▼, then press the **ENT** key.

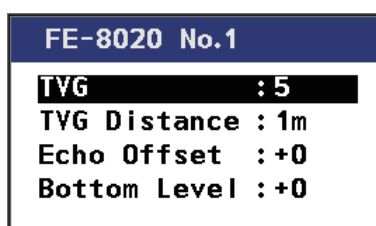

5. Select the parameter you wish to set using ▲ or ▼, then press the **ENT** key. This will open a pop-up window. The table below shows the available menu items and their available settings.

Menu item	Available setting range	Default
TVG	0 to 9	5
TVG Distance	1 m to 100 m	1 m
Echo Offset	-20 to +20	0
Bottom Level	-10 to +10	0

6. Adjust the parameter using ▲ or ▼, then press the **ENT** key to apply the settings and close the pop-up window.  
To keep the default setting, press ◀ or the **MENU/ESC** key.
7. Press the **MENU/ESC** key four times to close the menu.

### 2.2.1 Bottom level

If the depth indication is unstable or the seabed cannot be displayed steadily notwithstanding the adjustment of the control panel, you may adjust the bottom echo level.

To adjust the bottom level setting, see section 2.2.

**Note:** Do not switch transducer (frequency) at the Junction Box when setting the bottom level. If it is necessary to set bottom level for a different frequency, turn off the FE-800, switch transducer at Junction Box and then turn on the FE-800 again.

 <b>CAUTION</b>
<p>If the level is set too low, the FE-800 may not be able to distinguish the bottom from fish echo and the depth indication may be unstable. If set too high, the depth indication does not appear.</p>

## 2. SYSTEM MENU

### 2.2.2 TVG level

TVG (Time Varied Gain) compensates for propagation attenuation of the ultrasonic waves, reducing surface noise to provide a smooth display. The TVG lowers receiver sensitivity at the time of pulse emission and gradually increases it with time, thereby making objects of same reflectivity at different depths appear at the same intensity or colours on the display.

The TVG working depth is down to approximately 150 m on the 200 kHz system and 350 m on the 50 kHz system. Outside this range the echoes from the seabed and fish schools are received in full level. There is no perceivable deterioration in performance.

To adjust the TVG level or the TVG distance, see section 2.2.

**Note:** Do not switch transducers (frequency) at the Junction Box when setting the TVG level. If it is necessary to set TVG level for a different frequency, turn off the FE-800, switch transducers at the Junction Box and then turn on the FE-800 again.

### 2.2.3 Echo offset

The echo offset feature functions to compensate for too weak or too strong echo level.

If the on-screen echo level appears to be too weak or too strong and the level cannot be adjusted satisfactorily with the GAIN control, see section 2.2 to adjust the TVG level.

## 2.3 How to Set TX Rate

TX rate adjusts the rate at which the FE-800 transmits a signal. The TX rate can be adjusted to compensate for noise created by other sounders.

1. Press the **MENU/ESC** key to open the Main menu.
2. Select [System] using ▲ or ▼, then press the **ENT** key.
3. Select [Parameters] using ▲ or ▼, then press the **ENT** key.
4. Select [TX Rate] using ▲ or ▼, then press the **ENT** key. This will open a pop-up window.

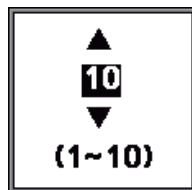

5. Adjust the [TX Rate] using ▲ or ▼, then press the **ENT** key to apply the settings and close the pop-up window. The higher the setting, the higher the rate at which the FE-800 outputs a signal. To keep the default setting (10), press ◀ or the **MENU/ESC** key.
6. Press the **MENU/ESC** key three times to close the menu.



## 2.4 How to Set Bottom Tail Display

You can change the colour of the stronger echoes on the seabed by using the [Bottom Tail Display] function.

1. Press the **MENU/ESC** key to open the Main menu.
2. Select [System] using ▲ or ▼, then press the **ENT** key.
3. Select [Parameters] using ▲ or ▼, then press the **ENT** key.
4. Select [Bottom Tail Display] using ▲ or ▼, then press the **ENT** key. This will open a pop-up window.
5. Select [OFF] or [ON] as appropriate, then press the **ENT** key to apply the settings and close the pop-up window.  
To keep the default setting, press ◀ or the **MENU/ESC** key.
6. Press the **MENU/ESC** key three times to close the menu.

## 2.5 How to Set Bottom Link RNG

The pulsewidth can be changed in conjunction with either the seabed depth or the display range.

1. Press the **MENU/ESC** key to open the Main menu.
2. Select [System] using ▲ or ▼, then press the **ENT** key.
3. Select [Parameters] using ▲ or ▼, then press the **ENT** key.
4. Select [Bottom Link RNG] using ▲ or ▼, then press the **ENT** key. This will open a pop-up window.
5. Select [OFF] or [ON] as appropriate, then press the **ENT** key to apply the settings and close the pop-up window. To keep the default setting, press ◀ or the **MENU/ESC** key.
6. Press the **MENU/ESC** key three times to close the menu.

## 2.6 How to Set the Speed of Sound

You can manually set the speed of sound to compensate for changes in temperature and salinity.

1. Press the **MENU/ESC** key to open the Main menu.
2. Select [System] using ▲ or ▼, then press the **ENT** key.
3. Select [Parameters] using ▲ or ▼, then press the **ENT** key.
4. Select [Speed of Sound] using ▲ or ▼, then press the **ENT** key. This will open a pop-up window.

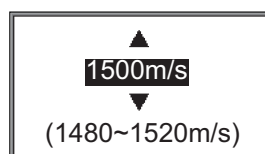

5. Adjust the parameter using ▲ or ▼, then press the **ENT** key to apply the settings and close the pop-up window. To keep the default setting, press ◀ or the **MENU/ESC** key.
6. Press the **MENU/ESC** key three times to close the menu.

## 2.7 Alert Menu

### 2.7.1 Active alert list

The [Active Alert] list shows the currently active alerts. The list can be shown through key or menu operation.

#### Key operation

Long-push the **ALARM ACK** key to display the active alert list.

#### Menu operation

Follow the procedure below to access the [Active Alert] list. Note that the [Alert] log can also be shown through menu operation.

1. Press the **MENU/ESC** key to open the Main menu.
2. Select [System] using ▲ or ▼, then press the **ENT** key.
3. Select [Alert] using ▲ or ▼, then press the **ENT** key.

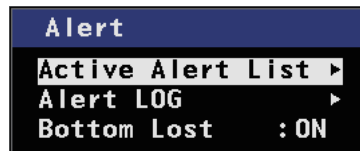

4. Select [Active Alert] list using ▲ or ▼, then press the **ENT** key.

Total number of active alerts

The screenshot shows the 'Active Alert List' screen. At the top, it displays 'ALERT <1>' on the left, 'RANGE : 4' in the center, and 'TRANSUDER' on the right. Below this, 'Active Alert 6' is shown on the left and '<01/06>' on the right. The main area contains a table of alerts:

Status	Alert	Time
▲	3031-1 SHALLOW DEPTH TCYR1 FORE depth below keel alarm.	15:57'36 26/Nov/2020
▲	3031-2 SHALLOW DEPTH TCYR1 AFT depth below keel alarm.	15:57'34 26/Nov/2020
!	3008-1 LOST MEAS TCYR1 TX voltage ERR stopped MEAS.	15:57'38 26/Nov/2020
→	3008-2 LOST MEAS TCYR1 RX voltage ERR stopped MEAS.	15:57'36 26/Nov/2020
!	3079-1 FAN SPEED LOW TCYR1 fan ERR may stop MEAS.	15:57'39 26/Nov/2020

Below the table, there are two depth readouts: 'AFT 50kHz' with '30.0m' and 'FORE 200kHz' with '30.0m'. At the bottom, there is a status bar showing '3031-1 SHALLOW DEPTH', 'ALARM ACK', a warning icon, and 'Time 16:06'.

Annotations in the image:





- An arrow points to the '6' in 'Active Alert 6' with the label 'Total number of active alerts'.
- An arrow points to the '<01/06>' with the label 'Page No.'.
- An arrow points to the third row of the alert table with the label 'Log entry'.
- An arrow points to the '30.0m' depth readout with the label 'Depth'.

5. To change pages, use ◀ or ▶.
6. Press the **DISP** key to close the open menus.



## 2.7.2 How to display the alert log

The [Alert Log] tracks all alerts.





1. Press the **MENU/ESC** key to open the Main menu.
2. Select [System] using ▲ or ▼, then press the **ENT** key.
3. Select [Alert] using ▲ or ▼, then press the **ENT** key.
4. Select [Alert Log] using ▲ or ▼, then press the **ENT** key.

Status	Alert	Time
	3031-1 SHALLOW DEPTH TCVR1 FORE depth below keel alarm.	12:34'56 01/Jan/2020
	3031-2 SHALLOW DEPTH TCVR1 AFT depth below keel alarm.	12:34'55 01/Jan/2020
	3008-1 LOST MEAS TCVR1 TX voltage ERR stopped MEAS.	12:34'54 01/Jan/2020
	3008-2 LOST MEAS TCVR1 RX voltage ERR stopped MEAS.	12:34'53 01/Jan/2020
	3079-1 FAN SPEED LOW TCVR1 fan ERR may stop MEAS.	12:34'52 01/Jan/2020

	OFFSET 0.0m		OFFSET 0.0m
<b>30.0m</b>		<b>30.0m</b>	

	3031-1 SHALLOW DEPTH					Time 16:49
---	----------------------	---	--	---	---	------------

**Note:** The above example shows alerts which are output under Alert I/F2 settings. The alert ID differs depending on the alert format selected at installation. To change the alert format, consult a FURUNO technician.

For more information about alert codes and meanings, see "ALERT MESSAGES" on page AP-7.

5. To change pages, use ◀ or ▶.
6. Press the **DISP** key to close the open menus.

## 2. SYSTEM MENU

### 2.7.3 Bottom lost

When the bottom echo is lost, the audible alarm sounds and the alarm message is displayed in the alert display area at the bottom of the screen.

**Note:** The alarm code may be displayed with only the final three digits, depending on the Alarm Mode selected.

To adjust the alert settings, do the following:

1. Press the **MENU/ESC** key to open the Main menu.
2. Select [System] using ▲ or ▼, then press the **ENT** key.
3. Select [Alert] using ▲ or ▼, then press the **ENT** key.
4. Select [Bottom Lost] using ▲ or ▼, then press the **ENT** key.

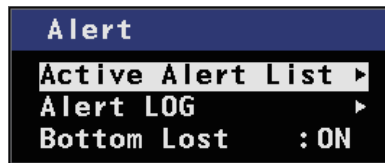

5. Select [ON] to output an alert, select [OFF] to stop alert output.
6. Press the **DISP** key to close the open menus.

## 2.8 Alarms, Warnings and Cautions

When an error occurs, the system will attempt to notify the user with an audible alarm.

The footer at the bottom of the display shows the highest priority alert of all the alerts that are occurring.

When more than one alert is active, alerts other than the latest alert with the highest priority are shown as “background alert icon” in the footer at the bottom of the display. The background alert icon reflects the background alert’s priority as follows:

- Red triangle with “A”: Alarm level
- Yellow-orange circle with “W”: Warning level
- Yellow square with “C”: Caution level

Status	Alert	Time
▲	3031-1 SHALLOW DEPTH TCVR1 FORE depth below keel alarm.	15:57'36 26/Nov/2020
▲	3031-2 SHALLOW DEPTH TCVR1 AFT depth below keel alarm.	15:57'34 26/Nov/2020
!	3008-1 LOST MEAS TCVR1 TX voltage ERR stopped MEAS.	15:57'38 26/Nov/2020
→	3008-2 LOST MEAS TCVR1 RX voltage ERR stopped MEAS.	15:57'36 26/Nov/2020
!	3079-1 FAN SPEED LOW TCVR1 fan ERR may stop MEAS.	15:57'39 26/Nov/2020

AFT 50kHz	OFFSET 0.0m	FORE 200kHz	OFFSET 0.0m
30.0m		30.0m	
▲ 3031-1 SHALLOW DEPTH		ALARM ACK ▲ W C Time 16:06	

The footer shows the latest alert with the highest priority among all alerts.

Background alert icon  
Displayed when alerts other than the alert displayed at the footer message area are generated (more than one alert is generated).

Press the **ALARM ACK** key to acknowledge the alert and stop the audible alarm. When more than one alert is active, acknowledge each individual alert.

**Note:** All notifications are stored in the Alert LOG.

Depending on your Alert mode, Alert ID can be in two formats, 3-digit or 4-digit, followed by instance number (for example, “-1”).

See "ALERT MESSAGES" on page AP-7 for a full list of alert codes, their meanings and possible remedies.

### Alert priority

The level of priority, from highest to lowest, is ALARM → WARNING → CAUTION. For detailed information regarding specific alerts and alert codes, including possible remedies, see page AP-7.

**Alarm:** Situations or conditions which require immediate attention, decision and (if necessary) action by the bridge team to avoid any kind of hazardous situation and to maintain the safe navigation of the ship.

## 2. SYSTEM MENU

**Warning:** Situations or conditions which require immediate attention for precautionary reasons, to make the bridge team aware of conditions which are not immediately hazardous, but may become so.

**Caution:** Awareness of a condition which continues to require attention out of the ordinary consideration of the situation or of given information.

**Note:** All active-unacknowledged warnings are repeated as warnings after 4 minutes 50 seconds (manufacturer's fixed time period).

### **Alert category**











An alert is further classified by category, A, B or C, according to its degree of severity or source.

<b>Category</b>	<b>Description</b>
A	Category A alerts include the following, and must be confirmed from the equipment that generated the alert. <ul style="list-style-type: none"><li>• Danger of collision</li></ul>
B	Category B alerts are alerts where no additional information for decision support is necessary. Category B alerts are all alerts not falling under category A.
C	Category C alerts are not shown on this equipment.

**Note 1:** This equipment does not provide the functional alert group function.

**Note 2:** The reserved cluster identifier for this equipment, which is defined in IEC62923-2 is "Nav".

### 2.8.1 Alert icons and their meanings

Icon	Description	Priority	Icon colour
	Active-unacknowledged notification, icon is flashing. The cause of the notification is still present. Flashing: One second interval, 0.5 second ON time. Buzzer: Three short audible beeps, followed by seven seconds silence, then repeats.	Alarm	Red
	Active-silenced notification, icon is flashing. The buzzer has been silenced, the cause of the notification is still present. Flashing: One second interval, 0.5 second ON time. Buzzer: Silent.	Alarm	Red
	Rectified-unacknowledged notification, icon is flashing. Flashing: Four second interval, three second ON time. Buzzer: Silent.	Alarm	Red
	Active-acknowledged, icon is displayed steadily.	Alarm	Red
	Active-responsibility transferred, icon is displayed steadily.	Alarm	Red
	Active-unacknowledged notification, icon is flashing. Flashing: One second interval, 0.5 second ON time. Buzzer: Two short audible beeps, followed by 4 minutes 50 seconds silence, then repeats.	Warning	Orange
	Active-silenced notification, icon is flashing. Flashing: One second interval, 0.5 second ON time. Buzzer: Silent.	Warning	Orange
	Rectified-unacknowledged notification, icon is flashing. Flashing: One second interval, 0.5 second ON time. Buzzer: Silent.	Warning	Orange
	Active-responsibility transferred, icon is displayed steadily.	Warning	Orange
	Active-acknowledged, icon is displayed steadily.	Warning	Orange
	Active, icon is displayed steadily.	Caution	Yellow

### 2.8.2 Responsibility transfer alert

The “responsibility transfer alert” functions in the multiple sensor, multiple equipment installation. When one sensor or one equipment fails but does not disturb the system operation (other sensor or equipment is normal), the CAM authority sends the “responsibility transfer alert” (ACN sentence) to the sensor or equipment that generated the alert.

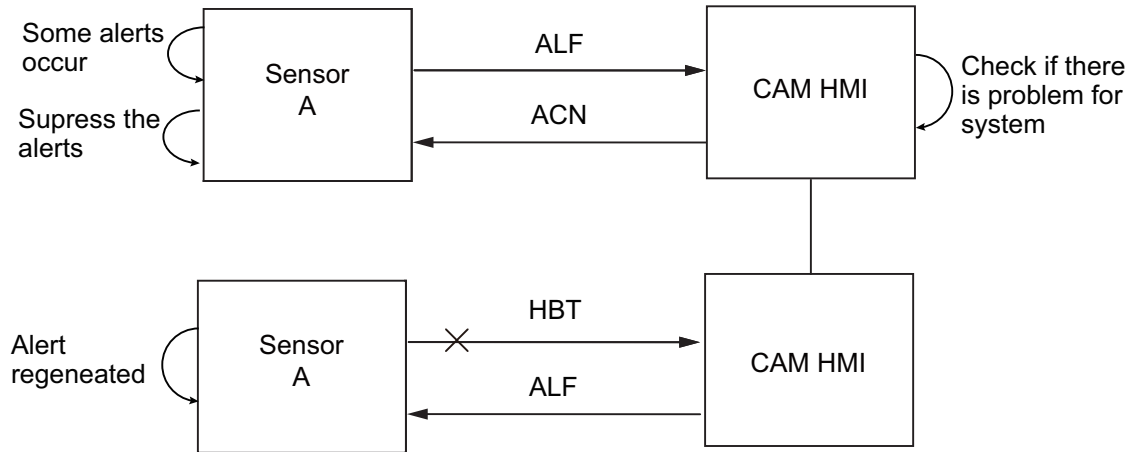

If the sensor or equipment refuses the responsibility transfer, normal operation is restored.

If the HBT sentence is not received from the CAM within the prescribed time interval, the alert processed as responsibility transfer alert is made active.

### 2.8.3 Repeat of Warning alert

For a Warning alert to become an Alarm alert, the alert priority must be changed. In most cases the Warning alert is simply repeated. In general, only the alerts specified by the IMO can become Alarm alerts.

When the external equipment generates a Warning alert, the Warning alert is repeated or the priority is changed to “Alarm.” The latter case is known as “Alert Escalation”.

The external equipment controls the interval at which a Warning alert is repeated. The external equipment sends the ALF sentence to CAM to notify the CAM of repeat of a Warning alert. The CAM also repeats the Warning alert.

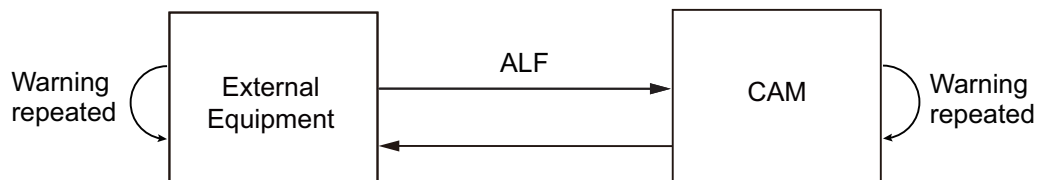



## 2.9 How to Set or Adjust the Time

The unit can display the time from an external EPFS device (such as GPS), or the unit's internal clock. The time source is selected during the initial installation and requires a FURUNO technician to adjust the setting. The source which has not been selected at installation will be displayed as a grey, unselectable menu item in the [Ship's Time] menu. The example below shows [External] as the selected source, with [Internal] as unselectable (grey).



In configurations where the time source is set to [External] and the source signal is lost (for example, the GPS fails), the unit reverts to the internal clock and the time is displayed with an asterisk.

### 2.9.1 External time

1. Press the **MENU/ESC** key to open the Main menu.
2. Select [System] using **▲** or **▼**, then press the **ENT** key.
3. Select [Ship's Time] using **▲** or **▼**, then press the **ENT** key.
4. Select [External] using **▲** or **▼**, then press the **ENT** key.

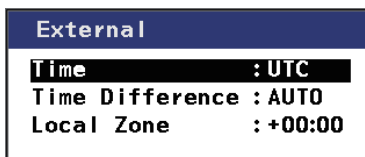

5. Select [Time], [Time Difference] or [Local Zone] as appropriate, using **▲** or **▼**, then press the **ENT** key. A pop-up window appears.

Menu item	Setting range	Default
Time	UTC (UTC Time difference) Local (Ship's local time)	<b>UTC</b>
Time Difference	Auto or Manual	<b>AUTO</b>
Local Zone	-13:45 to +13:45 (at 15 minute intervals)	<b>0:00</b>

6. Adjust the parameter using **▲** or **▼**, then press the **ENT** key to apply the settings and close the pop-up window. To keep the default setting, press the **DISP** key or the **MENU/ESC** key.
7. Press the **MENU/ESC** key four times to close the menu.

## 2. SYSTEM MENU

### 2.9.2 Internal time

The internal clock can be set to show the day, month, year, hour, minute and second. By default, this is set to "00:00:00 1/Jan/2014". You can adjust the time as follows.

1. Press the **MENU/ESC** key to open the Main menu.
2. Select [System] using ▲ or ▼, then press the **ENT** key.
3. Select [Ships's Time] using ▲ or ▼, then press the **ENT** key.
4. Select [Internal] using ▲ or ▼, then press the **ENT** key. This will open a pop-up window.



5. Select [Date] or [Time] as appropriate, using ▲ or ▼, then press the **ENT** key.

Setting	Format
Date	Day/Month/Year
Time	Hours:minutes:seconds

6. Adjust the parameter using ▲ or ▼, then press the **ENT** key to apply the settings and close the pop-up window. To keep the default setting, press the **DISP** key or the **MENU/ESC** key.
7. Press the **MENU/ESC** key four times to close the menu.

### 2.10 Key Beeps

Each key press on the FE-800 can produce a beep sound. You can turn the key beep off by doing the following.

1. Press the **MENU/ESC** key to open the Main menu.
2. Select [System] using ▲ or ▼, then press the **ENT** key.
3. Select [Key Sound] using ▲ or ▼, then press the **ENT** key.

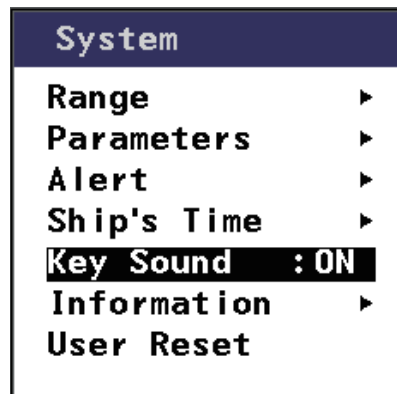

4. Select [ON] to output a sound, select [OFF] to stop sound output.
5. Press the **DISP** key to close the menu.

## 2.11 How to Set Up the FE-800 for Data Recording

The following setup procedure is required before using the optional data recording software.

1. Press the **MENU/ESC** key to open the Main menu.
2. Select [System] using ▲ or ▼, then press the **ENT** key.
3. Select [Data Recorder] using ▲ or ▼, then press the **ENT** key.

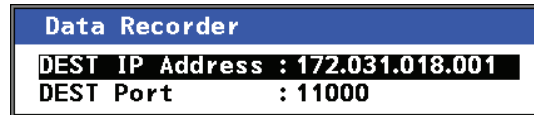

4. Select [DEST IP Address] using ▲ or ▼, then press the **ENT** key. This will open a pop-up window to set the IP address of the connected PC.

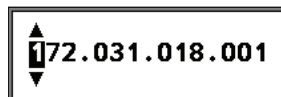

The available setting range is [000.000.000.000] to [255.255.255.255].

**Note:** Do not use the following IP range: [239.192.000.001] to [239.192.000.064].

5. Press ▲ to increase or ▼ to reduce the value of the highlighted digit. Press ◀ or ▶ to select a digit to set. To complete the setting process for the IP address, press ▶ until the cursor passes the final digit.
6. Select [DEST Port] using ▲ or ▼, then press the **ENT** key. A pop-up window to set the destination port on the connected PC appears.



The available setting range is [00000] to [65535].

7. Press ▲ to increase or ▼ to reduce the value of the highlighted digit. Press ◀ or ▶ to select a digit to set. To complete the setting process for the Port, press ▶ until the cursor passes the final digit.
8. Press the **DISP** key to close the menu.

## 2.12 How to Set Draught from External Equipment

To use the draught value from external equipment, do the following:

1. Press the **MENU/ESC** key to open the Main menu.
2. Select [System] using ▲ or ▼, then press the **ENT** key.
3. Select [EXT Setting] using ▲ or ▼, then press the **ENT** key.

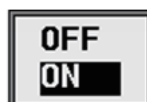

4. Select [ON] ▲ or ▼, then press the **ENT** key.
5. Press the [DISP] to close the menu.

## 2.13 How to Adjust the Dimmer from External Equipment

To change the dimmer settings from external equipment, do the following:

1. Press the **MENU/ESC** key to open the Main menu.
2. Select [System] using ▲ or ▼, then press the **ENT** key.
3. Select [Remote Dimmer] using ▲ or ▼, then press the **ENT** key.
4. Select [ON] ▲ or ▼, then press the **ENT** key.
5. Press [DISP] key to close the menu.



**Note:** When [Dimmer Mode] in the [System] menu is set to [FE-800], the menu is not available. To use this function, contact your local dealer.

## 2.14 System Information

The system information display shows information about your FE-800 unit and the transceiver(s) connected to it. The figure below is an example of the information screen.

1. Press the **MENU/ESC** key to open the Main menu.
2. Select [System] using ▲ or ▼, then press the **ENT** key.
3. Select [Information] using ▲ or ▼, then press the **ENT** key. A confirmation pop-up window will appear.
4. Select [FE-8010], [FE-8020 No.1] or [FE-8020 No.2] as appropriate using ▲ or ▼, then press the **ENT** key.

FE-8020 No.1	
Unit Name	: FE-8020
Serial No	: XXXXX
Program No	: 1251003-XX.XX
ROM	: OK
RAM	: OK

Equipment's unique serial number

Software program and version number

5. Press the **DISP** key to close the open menus.



## 2.15 User Reset

You can restore the factory default settings using this menu.

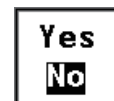
1. Press the **MENU/ESC** key to open the Main menu.
2. Select [System] using ▲ or ▼, then press the **ENT** key.
3. Select [User Reset] using ▲ or ▼, then press the **ENT** key. A confirmation pop-up window will appear.
4. Select [YES] or [NO] as appropriate using ▲ or ▼, then press the **ENT** key.
5. Press the **MENU/ESC** key twice to close the menu.



# 3. MAINTENANCE AND TROUBLESHOOTING

 <b>WARNING</b>	<b>NOTICE</b>
 <b>Do not open the cover.</b> There are no user-serviceable parts inside.  Refer any repair work to a qualified technician.	<b>Do not apply paint, anti-corrosive sealant or contact spray to coating or plastic parts of the equipment.</b>  Those items contain organic solvents that can damage coating and plastic parts, especially plastic connectors.

## 3.1 Checklist

Regular maintenance is essential for good performance. Checking the items listed below on a regular basis will keep the equipment in good shape for years to come.

Item	Action
Cable run	If conductors are exposed, replace cable.
Display unit ground/transceiver ground	If corroded, clean.
Ship's main voltage	If out of rating, correct the problem.

## 3.2 Cleaning the Display Unit

Dust or dirt on the cabinet can be removed with a soft cloth. If desired, a water-moistened cloth may be used. Do not use chemical cleaners, they may remove paint and markings.

To clean the LCD, wipe the LCD carefully to prevent scratching, using tissue paper and an LCD cleaner. To remove dirt or salt deposits, use an LCD cleaner, wiping slowly with tissue paper so as to dissolve the dirt or salt. Change paper frequently so the salt or dirt will not scratch the LCD. Do not use solvents such as thinner, acetone or benzene for cleaning. Also, do not use a degreaser or an antifog solution, as they can strip the coating from the LCD.

## 3.3 Transducer Maintenance

Marine life on the transducer face will result in a gradual decrease in sensitivity.

Check the transducer face for cleanliness each time the ship is dry-docked. Carefully remove any marine life with a piece of wood or fine-grade sandpaper.

## 3.4 Fan and LCD Backlight Life Expectancy

Item	Life Expectancy
Fan	60,000 hours at 60°C
LCD backlight	60,000 hours at 35°C

## 3.5 Replacing the Fuse/Battery

If a fuse blows, find the cause before replacing it. Use only designated fuses. Using the wrong fuse will damage the unit and void the warranty. Consult your dealer for replacement of the fuse.

A battery installed on a circuit board inside the transceiver unit preserves data when the power is turned off. The life of the battery is about five years. When the battery voltage is low, a warning message "Displayed time may be incorrect. Please re-set the clock." appears after the self-test. When this happens, contact your dealer to request a replacement of the battery. Press any key to proceed to the main display screen.

**Note:** The message "Displayed time may be incorrect. Please re-set the clock." appears when the FE-800 is turned on for the first time or after changing the battery. In this case, the battery does not need replacement, however the clock must be set.

Item	Type	Code Number
Lithium Battery	BR-1225-A/BK	000-178-989-10
Glass Tube Fuse (for AC input, 2 pcs)	FGMB 250V 2A PBF	000-157-497-10

## 3.6 Troubleshooting

The table below provides simple troubleshooting procedures which you may follow to restore normal operation. If you cannot restore normal operation, contact your dealer.

SYMPTOM	PROBABLE CAUSE	REMEDY
No picture, no reading measure	Low voltage	Check the supply voltage.
	Fuse blown	Refer to section 3.5.
	Power cable damaged	Repair the cable.
No echo sounding picture	Transducer cable damaged	Repair the cable.
	Transducer cable connection loosened	Tighten the connections.
Irregular display	Low sensitivity	Increase the gain (refer to section 1.7).
	Low reflectivity from seabed.	Suspect muddy seabed.
	Marine life on transducer	Remove marine life from the transducer when dry-docked.
Loss of seabed display	Out of range	Check the range scale setting.
	Air bubbles caused by going astern or running over other ships' wake	This is normal. It is not a sign of equipment trouble.
Heavy noise	Wrong installation at the transducer	Find cause of noise. Relocate the transducer if noise persists.
	Other echo sounders nearby	If more than one echo sounder is working on the ship, there is no ideal measure to cure the problem.
Surface noise	Aeration in near surface water	Not an equipment problem.
	Rough weather	Not an equipment problem.
"Not Connected" appears on the screen	Communication between the Display Unit and Transceiver unit is interrupted or lost	Connection(s) may be loose or disconnected. Check the connections between the Display Unit and Transceiver unit. Tighten loose connectors and re-connected disconnected connectors.

# APPENDIX 1 MENU TREE

---

## MAIN MENU

- | 1 Day/Night
- | 2 Depth Alarm
- | 3 Output Depth
- | 4 FE-8020 Select
- | 5 Sounder
- | 6 Display
- L 7 System

*All default settings are in bold italic*

- 1 Dimmer Mode: In case of FE-800, Day/Night (**Day**/Night)  
Dimmer Mode: In case of ECDIS, Day/Dusk/Night (**Day**/Dusk/Night)

- 2 Depth Alarm (0 to 2400m) **Default=20m**

- 3 Output Depth (AFT/FORE)

- 4 FE-8020 Select (**No. 1**, No. 2)

- 5 Sounder

- | DEPTH (BELOW) (Transducer, **Keel**, Surface)
- | FE-8020 No. 1
  - | Draught (**0.0m** to 30.0m)
  - | Manual GAIN (0 to 9) **Default=5**
  - | AUTO GAIN (OFF, **ON**)
  - | AUTO GAIN ADJ (-10 to +10) **Default=0**
  - | Clutter (0 to 7) **Default=7**
  - L IR (**OFF**, IR1, IR2, IR3)
- | FE-8020 No. 2
  - | Draught (**0.0m** to 30.0m)
  - | Manual GAIN (0 to 9) **Default=5**
  - | AUTO GAIN (OFF, **ON**)
  - | AUTO GAIN ADJ (-10 to +10) **Default=0**
  - | Clutter (0 to 7) **Default=7**
  - L IR (**OFF**, IR1, IR2, IR3)
- | PICT Advance (**SLOW**, FAST)
- L Auto Range (**OFF**, ON)

- 6 Display

- | LOGBOOK
- | Echo (FORE, AFT, **DUAL**)
- | Depth (SINGLE, **DUAL**)
- | Interval (5s, **1 min**, 2 min)
- | Unit
  - | Depth (**m**, ft)
  - L Speed (**kn**, MPH, km/h)
- | Course (**True**, Magnetic)
- L Colour (**Amber**, Black, Blue, White)

APPENDIX 1 MENU TREE

6 Display

- Dimmer Preset
  - Display (Day) (1 to 9) **Default=9**
  - Display (Dusk) (1 to 9) **Default=5**
  - Display (Night) (1 to 9) **Default=2**
  - Panel (Day) (1 to 9) **Default=2**
  - Panel (Dusk) (1 to 9) **Default=2**
  - Panel (Day) (1 to 9) **Default=2**
  - Colour (Day) (**Amber**, Black, Blue, White)
  - Colour (Dusk) (**Amber**, Black, Blue, White)
  - Colour (Night) (**Amber**, Black, Blue, White)

7 System

- Range
  - Basic Range1 (2 to 18) **Default=5m**
  - Basic Range2 ((BR1+1) to (BR3-1)) **Default=10m**
  - Basic Range3 (20) **Default=20m**
  - Basic Range4 (21 to (BR5-1)) **Default=40m**
  - Basic Range5 ((BR4+1) to 199) **Default=100m**
  - Basic Range6 (200) **Default=200m**
  - Basic Range7 (201 to (BR8-1)) **Default=400m**
  - Basic Range8 ((BR7+1) to 2400) **Default=800m**
- System Parameters
  - No. 1 Parameters
    - TVG (0 to 9) **Default=5**
    - TVG Distance (**1m** to 100m)
    - Echo Offset (-20 to +20) **Default=0**
    - Bottom Level (-10 to +10) **Default=0**
  - No. 2 Parameters
    - TVG (0 to 9) **Default=5**
    - TVG Distance (**1m** to 100m)
    - Echo Offset (-20 to +20) **Default=0**
    - Bottom Level (-10 to +10) **Default=0**
  - TX Rate (1 to 10) **Default=10**
  - Bottom Tail Display (**OFF**, ON)
  - Bottom Link RNG (**OFF**, ON)
  - Speed of Sound (1480 to 1520) **Default=1500m/s**
- Alert
  - Active Alert List
  - Alert Log
  - Bottom Lost (OFF, **ON**)
- Ship's Time
  - External
    - Time (**UTC**, Local)
    - Time Difference (**AUTO**, Manual)
    - Local Zone (-13:45 to +13:45) **Default=0:00**
  - Internal
    - Date (**01/01/2014** to 31/12/2099)
    - Time (**00:00:00** to 23:59:59)



- 7 System
  - Key Sound (OFF, **ON**)
  - Data Recorder
    - DEST IP Address (000.000.000.000 to 255.255.255.255)  
**Default=172.031.018.001**
    - DEST Port (00000 to 65535)  
**Default=11000**
  - EXT Setting (**OFF**, ON)
  - Remote Dimmer (**OFF**, ON)
  - Information
    - FE-8010
    - FE-8020 No. 1
    - FE-8020 No. 2
  - User Reset (YES, NO)

# APPX. 2 PARTS LOCATIONS

## Transceiver unit FE8020

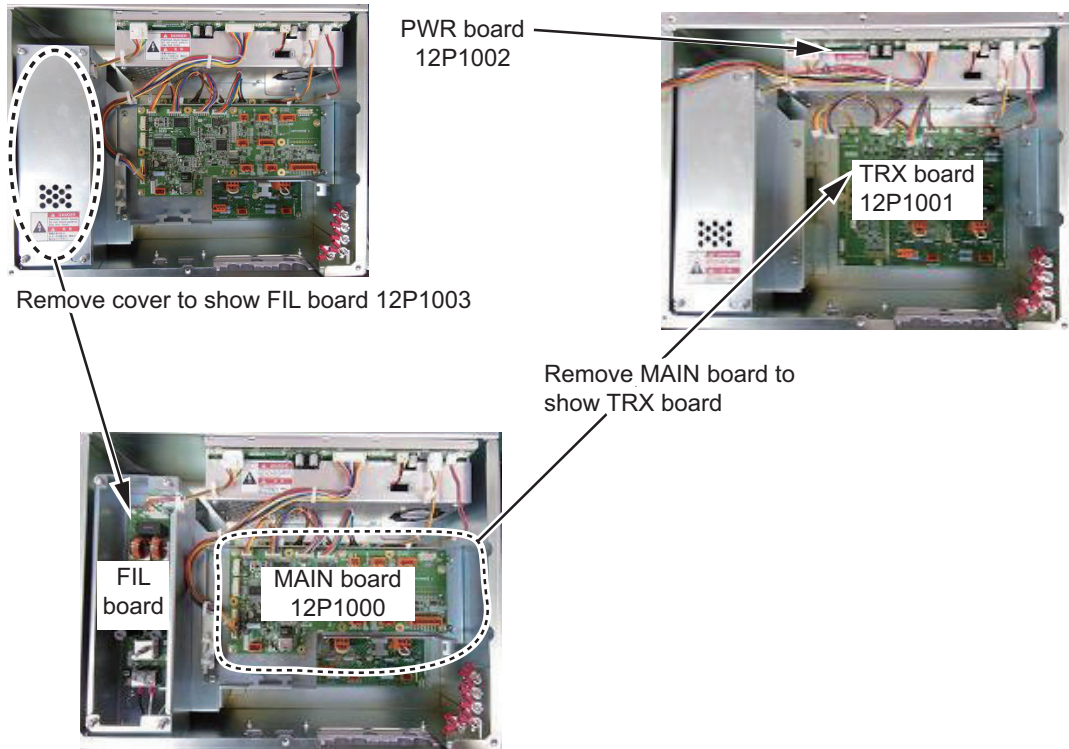

## Display unit FE-8010

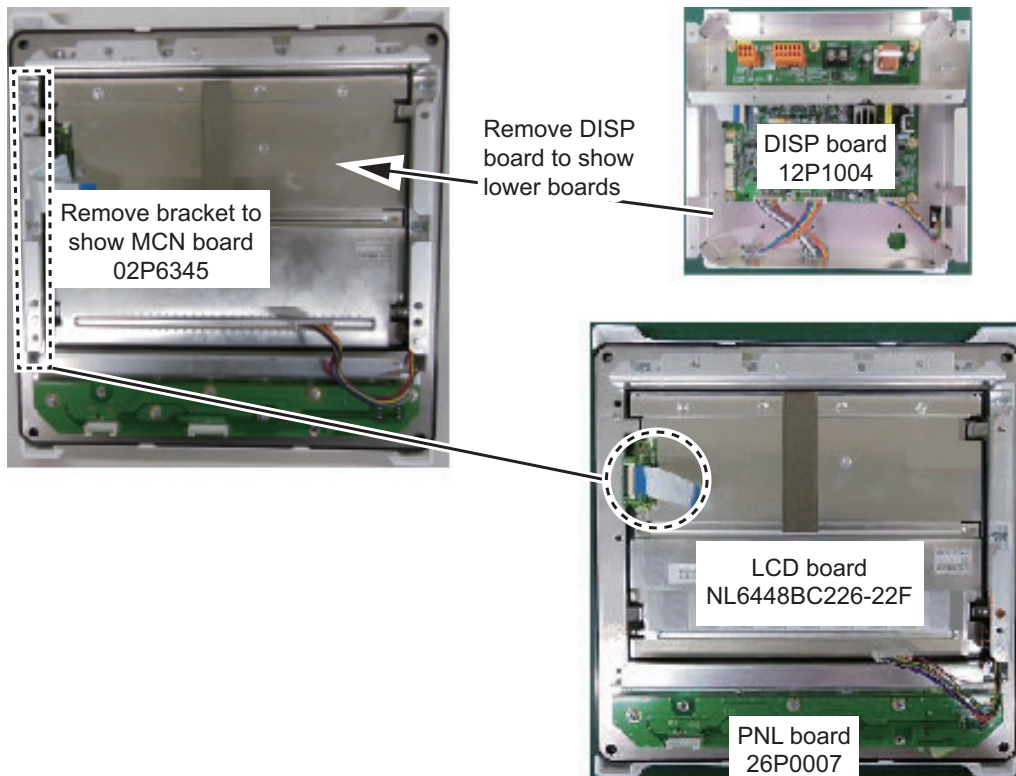

# APPX. 3 LIST OF TERMS AND ABBREVIATIONS

Term	Meaning	Term	Meaning
ADD	Address	I/O	Input/Output
ACK	Acknowledge	IP	Internet Protocol
ADJ	Adjust	Jan	January
AFT	Aft	Jul	July
ALARM	Alarm	Jun	June
ALERT	Alert	KEEL	Keel
Apr	April	kn	Knots
Aug	August	km/h	Kilometers per hour
AUTO	Automatic	KP	Keying Pulse
BRILL	Brilliance	LA	Loran A
CAM	Central Alert Management	LC	Loran C
COG	Course Over the Ground	LCD	Liquid Crystal Display
COM	Communication	LOG	Log
CONFIG	Configuration	LOGBOOK	Logbook
DATA	Data	m	Meters
DBS	Depth Below Surface	Mar	March
DE	Decca Navigator	May	May
Dec	December	MEAS	Measurement
DEMO	Demonstration	MENU	Menu
DEST	Destination	MPH	Miles Per Hour
DISP	Display	NAV	Navigation
DRAUGHT	Draught	NMEA	National Marine Electronics Association
ENT	Enter	Nov	November
EPFS	Electronic Position Fixing System	Oct	October
ESC	Escape	OFF	Off
EQUIP	Equipment	ON	On
ERR	Error	OS	Own Ship
EXT	External	PICT	Picture
ft	Feet	POSN	Position
FAN	Fan	RAM	Random Access Memory
Feb	February	RNG, RANGE	Range
FORE	Fore	ROM	Read Only Memory
FUNC	Function	RX	Receive
GA	Galileo positioning system	SEL	Select
GAIN	Gain	Sep	September
GL	GLONASS positioning system	SFI	System Function ID
GN	Global navigation satellite system	SOG	Speed Over the Ground
GP, GPS	Global Positioning System	SURFACE	Surface
HISTORY	History	T	True
HMI	Human Machine Interface	TEST	Test
IEC	International Electrotechnical Commission	TCVR	Transceiver

APPX. 3 LIST OF TERMS AND ABBREVIATIONS

<b>Term</b>	<b>Meaning</b>	<b>Term</b>	<b>Meaning</b>
II	Integrated Instrumentation	TRANSDUCER, XDR	Transducer
IN	Integrated Navigation	TVG	Time Varied Gain
IR	Interference Rejector	TX	Transmit
I/F	Interface	UTC	Universal Time, Coordinated

# APPX. 4 ALERT MESSAGES

The alert modes Alert I/F1, Alert I/F2 and Legacy settings are set during the initial installation. Consult a FURUNO technician to change these settings.

## Alert I/F2

Alert Title	Alert Description Text	Priority/Category	Alert ID, Instance	Meaning	Measures
SHALLOW DEPTH	TCVR1 FORE depth below keel alarm.	Alarm/A	3031, 1	Depth at fore transducer is shallower than that set for the alarm.	Check the depth visually.
	TCVR1 AFT depth below keel alarm.	Alarm/A	3031, 2	Depth at aft transducer is shallower than that set for the alarm.	
	TCVR2 FORE depth below keel alarm.	Alarm/A	3031, 3	Depth at fore2 transducer is shallower than that set for the alarm.	
	TCVR2 AFT depth below keel alarm.	Alarm/A	3031, 4	Depth at aft2 transducer is shallower than that set for the alarm.	
LOST MEAS	TCVR1 TX voltage ERR stopped MEAS.	Warning/B	3008, 1	Transceiver 1 PWR board or TRX board may be damaged. Voltage is not within safe guidelines	Consult a FURUNO technician.
	TCVR2 TX voltage ERR stopped MEAS.	Warning/B	3008, 4	Transceiver 2 PWR board or TRX board may be damaged. Voltage is not within safe guidelines.	
	TCVR1 RX voltage ERR stopped MEAS.	Warning/B	3008, 2	Transceiver 1 PWR board or TRX board may be damaged. Voltage is not within safe guidelines.	
	TCVR2 RX voltage ERR stopped MEAS.	Warning/B	3008, 5	Transceiver 2 PWR board or TRX board may be damaged. Voltage is not within safe guidelines.	
	TCVR1 temperature ERR stopped MEAS.	Warning/B	3008, 3	Transceiver 1 Temperature is above safe guidelines.	
	TCVR2 temperature ERR stopped MEAS	Warning/B	3008, 6	Transceiver 2 Temperature is above safe guidelines.	

APPX. 4 ALERT MESSAGES

Alert Title	Alert Description Text	Priority/Category	Alert ID, Instance	Meaning	Measures
BOTTOM LOST *	TCVR1 FORE bottom losts.	Warning/B (Caution/B)	3055, 1(3056, 1)	Seabed at fore transducer cannot be detected	Check that the seabed is within range. If the problem recurs, consult a FURUNO technician.
	TCVR1 AFT bottom losts.	Warning/B (Caution/B)	3055, 2(3056, 2)	Seabed at aft transducer cannot be detected.	
	TCVR2 FORE bottom losts.	Warning/B (Caution/B)	3055, 3(3056, 3)	Seabed at fore2 transducer cannot be detected.	
	TCVR2 AFT bottom losts.	Warning/B (Caution/B)	3055, 4(3056, 4)	Seabed at aft2 transducer cannot be detected.	
LOST DISP	DISP COM ERR stops display update.	Caution/B	3003, 1	Communication error between display unit and transceiver 1.	Consult a FURUNO technician.
LOST TCVR	TCVR2 COM ERR stops MEAS.	Caution/B	3003, 2	Communication error between display unit and transceiver 2.	
FAN SPEED LOW	TCVR1 fan ERR may stop MEAS.	Caution/B	3079, 1	Fan No.1 speed lower than minimum speed on transceiver 1.	
	TCVR2 fan ERR may stop MEAS.	Caution/B	3079, 2	Fan No.2 speed lower than minimum speed on transceiver 2.	
BOTTOM LOST	TCVR1 FORE bottom outs of range.	Caution/B	3056, 5	Seabed at fore transducer is out of range and cannot be detected	
	TCVR1 AFT bottom outs of range.	Caution/B	3056, 6	Seabed at aft transducer is out of range and cannot be detected.	
	TCVR2 FORE bottom outs of range.	Caution/B	3056, 7	Seabed at fore2 transducer is out of range and cannot be detected.	
	TCVR2 AFT bottom outs of range.	Caution/B	3056, 8	Seabed at aft2 transducer is out of range and cannot be detected.	

\*: Depending on setting for [Bottom Lost Priority] selected at installation, BOTTOM LOST may be output as a Category B Caution, with the ID 3056.

Alert I/F1, Legacy

Alert Title	Alert Text	Priority/Category	Alert ID	Meaning	Measures
SHAL-LOW DEPTH	Depth below keel alarm.	Alarm/A	230	Depth below the Keel is too shallow.	Check the depth visually.
LOST MEAS	TCVR1 TX voltage ERR stopped MEAS.	Warning/B	101	Transceiver 1 PWR board or TRX board may be damaged. Voltage is not within safe guidelines.	Consult a FURUNO technician.
	TCVR1 RX voltage ERR stopped MEAS.	Warning/B	102	Transceiver 1 PWR board or TRX board may be damaged. Voltage is not within safe guidelines.	
	TCVR1 temperature ERR stopped MEAS.	Warning/B	103	Transceiver 1 Temperature is above safe guidelines.	
	TCVR2 TX voltage ERR stopped MEAS.	Warning/B	111	Transceiver 2 PWR board or TRX board may be damaged. Voltage is not within safe guidelines.	
	TCVR2 RX voltage ERR stopped MEAS.	Warning/B	112	Transceiver 2 PWR board or TRX board may be damaged. Voltage is not within safe guidelines.	
	TCVR2 temperature ERR stopped MEAS.	Warning/B	113	Transceiver 2 Temperature is above safe guidelines.	
BOTTOM LOST *	Bottom losts.	Warning/B (Caution/B)	001 (003)	Seabed at fore transducer cannot be detected	Check that the seabed is within range. If the problem recurs, consult a FURUNO technician.
LOST DISP	DISP COM ERR stops display update.	Caution/B	301	Communication error between display unit and transceiver 1.	Consult a FURUNO technician.
LOST TCVR	TCVR2 COM ERR stops MEAS.	Caution/B	302	Communication error between display unit and transceiver 2.	
FAN SPEED LOW	CVR1 fan ERR may stop MEAS.	Caution/B	104	Fan No.1 speed lower than minimum speed on transceiver 1.	
	TCVR2 fan ERR may stop MEAS.	Caution/B	114	Fan No.2 speed lower than minimum speed on transceiver 2.	
BOTTOM LOST	Bottom outs of range.	Caution/B	002	Seabed is out of range and cannot be detected.	

\*: Depending on setting for [Bottom Lost Priority] selected at installation, BOTTOM LOST may be output as a Category B Caution, with the ID 003.

**SPECIFICATIONS OF NAVIGATIONAL ECHO SOUNDER  
FE-800**

**1 TRANSCIEVER UNIT**

- 1.1 Transmit frequency 50 kHz, 200 kHz or alternating transmit among these frequencies
- 1.2 Output power 1 kWrms
- 1.3 Minimum range 2 m (50 kHz), 1 m (200 kHz)
- 1.4 Accuracy  $\pm 0.5$  m on the shallow range scale, respectively  $\pm 5$  m on the deep range scale, or  $\pm 2.5\%$  of the indicated depth, whichever is the greater

1.5 Basic display range

Unit	Range							
	1	2	3	4	5	6	7	8
Meter	5	10	20	40	100	200	400	800
Feet	15	30	60	120	300	600	1500	2500

- 1.6 Roll/pitch tolerance Rolling:  $\pm 10^\circ$ , Pitching:  $\pm 5^\circ$
- 1.7 Data recording period 24 hours at 5 second intervals, 1 hour at 1 second intervals
- 1.8 Recording data display 24 hours at 2 minute intervals,  
12 hours at 1 minute intervals,  
1 hour at 5 second intervals
- 1.9 Display mode “NAV”: Basic echo presentation with the depth below transducer, keel or sea surface  
“HISTORY”: Historical presentation with the depth  
“OS data”: Echo presentation with the pop-up table of present navigational data; L/L, course, speed, time, depth  
Dual-frequency display
- 1.10 Auto-mode Range, Gain
- 1.11 Picture advance speed 15 minutes (200 m range) or more
- 1.12 Alarm Shallow depth

**2 DISPLAY UNIT**

- 2.1 Display 8.4-inch color LCD, 640x480 (VGA) , 0.267 mm/dot
- 2.2 Picture color Echo: 8 colors, Character and ground: 3 colors
- 2.3 Interface RS-232C: 1 port (for printer)
- 2.4 Visible distance  
Depth 3.8 m  
Others 0.9 m nominal

**3 INTERFACE**

- 3.1 Number of ports  
Serial Input: 2, Output: 4 (IEC61162-1)  
LAN I/O: 1 (Ethernet 100base-TX, RJ45 connector), IEC61162-450, IEEE802.3 data link, IGMPv2 acceptable  
Contact closure 1 (Power-fail)  
KP output 1



## 3.2 Data sentences (IEC61162-1/450)

Input	ACK, ACN, DDC*3, GGA, GLL, HBT, RMA, RMC, SRP*4, VTG, ZDA
Output	ALC, ALF, ALR, ARC, DBK*1, DBS*1, DBT*2, DDC*3, DPT, HBT, SRP*4

\*1: Not SOLAS compliant. \*2: Available when the transducer face is same level as keel.

\*3: Available when [Dimmer Control] is set to 'ON'. \*4: for IEC61162-450 only

## 3.3 Output proprietary sentence

PFEC	msi (mandatory, for multiple transducer installation)
------	---

## 3.4 IEC61162-450 Transmission group (Datagram type: UdPbC only)

IN	MISC, NAVD, NETA, CAM1, CAM2
OUT	Arbitrary (default: NAVD)

## 3.5 Other network functions except IEC61162-450

SSDP, HTTP, Syslog, Furuno management Protocol (FMP),  
Optional data recording software communication protocol

## 3.6 Alarm output

Contact closure, Normal open/close (24 VDC/ 2 A)

## 4 POWER SUPPLY

4.1 Transceiver unit	100-230 VAC: 0.7-0.4 A, 1 phase, 50-60 Hz
4.2 Display unit	24 VDC, 0.4 A (supplied from transceiver unit)
4.3 Printer (option)	12-24 VDC: 1.3 A max. (for printing)

## 5 ENVIRONMENTAL CONDITIONS

5.1 Ambient temperature	-15°C to +55°C
5.2 Relative humidity	93% or less at +40°C
5.3 Degree of protection	
Transceiver unit	IP22: Bulkhead mount, IP20: Tabletop mount
Display unit	IP22
Matching box	IP45
5.4 Vibration	IEC 60945 Ed.4

## 6 UNIT COLOR

6.1 Transceiver unit	N2.5
6.2 Display unit	N2.5

# INDEX

---

<b>A</b>	
Alert menu.....	25
active alert list .....	25
alert log .....	26
bottom lost.....	27
Automatic operation .....	11
<b>B</b>	
Brilliance	
key.....	3
panel .....	3
<b>C</b>	
Clock .....	32
Clutter .....	12
Color scheme.....	19
Course display .....	18
<b>D</b>	
DBS.....	15
Depth below surface .....	15
Display modes .....	5
NAV.....	6
NAV + HISTORY.....	7
NAV + OS DATA.....	8
Display unit .....	18
Draught .....	16
<b>E</b>	
Echo quality	
bottom level.....	22
echo offset.....	23
TVG level .....	23
<b>F</b>	
Function key.....	14
how to store a function .....	14
<b>G</b>	
Gain .....	10
adjust.....	10
offset .....	11
<b>H</b>	
HISTORY mode .....	7
<b>I</b>	
Indications .....	5
Interference.....	12
<b>K</b>	
Key beeps .....	33
Key sound .....	33
<b>L</b>	
Logbook .....	17
logging interval.....	17
<b>M</b>	
Maintenance and troubleshooting .....	36
alarm list.....	28
battery replacement .....	37
cleaning the display.....	36
fuse replacement.....	37
transducer maintenance.....	36
Menu operations	
choosing the transceiver .....	15
Menu overview .....	9
<b>N</b>	
NAV Mode.....	6
<b>O</b>	
Operation .....	1
controls.....	1
power on/off .....	2
OS DATA mode .....	8
Other menu items	
user reset .....	34, 35
version.....	35
Output Depth.....	14
<b>P</b>	
PICT Advance .....	13
Power on/off .....	2
<b>R</b>	
Range selection .....	10
auto range .....	10
<b>S</b>	
Shallow depth alarm.....	13
System menu .....	21
range scale.....	21
System parameters	
bottom link RNG.....	24
bottom tail display .....	24
speed of sound.....	24
transducer .....	22
TRX rate.....	23
<b>T</b>	
Time .....	32
external .....	32
internal .....	33
Troubleshooting .....	37
<b>U</b>	
Unit of measurement.....	18

## Declaration of Conformity



# 0560

We **FURUNO ELECTRIC CO., LTD.**

(Manufacturer)

9-52 Ashihara-Cho, Nishinomiya City, 662-8580, Hyogo, Japan

(Address)

declare under our sole responsibility that the product

**NAVIGATIONAL ECHO SOUNDER FE-800**

(Serial No. 1000-14xx-xxxx)

(Model name, type number)

to which this declaration relates conforms to the following standard(s) or normative document(s)

IMO Resolution A.224(VII)	IEC 60945 Ed.4.0: 2002
IMO Resolution A.694(17)	IEC 61162-1 Ed.5.0: 2016
IMO Resolution MSC.36(63)	IEC 61162-450 Ed.2.0: 2018
IMO Resolution MSC.74(69)	IEC 62288 Ed.2.0: 2014
IMO Resolution MSC.97(73)	IEC 62923-1/2 Ed.1.0: 2018
IMO Resolution MSC.191(79)	ISO 9875 Ed.3.0: 2000
IMO Resolution MSC.302(87)	

(title and/or number and date of issue of the standard(s) or other normative document(s))

For assessment, see

- EC Type Examination (Module B) certificate No. MEDB000039F Rev.1 issued by DNV AS (0575), Norway.
- Product Quality System (Module D) certificate No. P 112 (Issue 62) issued by Telefication, The Netherlands.

This declaration is issued according to the Directive 2014/90/EU of the European Parliament and of the Council on marine equipment, and the Implementing Regulation (EU) 2021/1158.

On behalf of Furuno Electric Co., Ltd.

Nishinomiya City, Japan  
23 December 2021

(Place and date of issue)

Akihiko Kanechika  
Department General Manager  
Quality Assurance Department

(name and signature or equivalent marking of authorized person)

**ECF**

(Elemental Chlorine Free)

The paper used in this manual  
is elemental chlorine free.

**FURUNO ELECTRIC CO., LTD.**

9-52 Ashihara-cho,  
Nishinomiya, 662-8580, JAPAN

• FURUNO Authorized Distributor/Dealer

All rights reserved. Printed in Japan

Pub. No. OME-23840-H

(YOTA ) FE-800

A : MAY 2014

H : JUL. 01, 2022



0 0 0 1 7 9 8 2 6 1 7