

FURUNO

OPERATOR'S MANUAL

ELECTRONIC CHART DISPLAY AND INFORMATION SYSTEM (ECDIS)

Model **FMD-3100**

ECF

(Elemental Chlorine Free)

The paper used in this manual
is elemental chlorine free.

FURUNO ELECTRIC CO., LTD.

9-52 Ashihara-cho,
Nishinomiya, 662-8580, JAPAN

• FURUNO Authorized Distributor/Dealer

All rights reserved. Printed in Japan

Pub. No. OME-44840-G1

(YOSH) FMD-3100

A : FEB. 2014

G1 : DEC. 10, 2021



0 0 0 1 7 8 7 5 5 1 6

IMPORTANT NOTICES

General

- This manual has been authored with simplified grammar, to meet the needs of international users.
- The operator of this equipment must read and follow the instructions in this manual. Wrong operation or maintenance can void the warranty or cause injury.
- Do not copy any part of this manual without written permission from FURUNO.
- If this manual is lost or worn, contact your dealer about replacement.
- The contents of this manual and the equipment specifications can change without notice.
- The example screens (or illustrations) shown in this manual can be different from the screens you see on your display. The screens you see depend on your system configuration and equipment settings.
- Save this manual for future reference.
- Any modification of the equipment (including software) by persons not authorized by FURUNO will void the warranty.
- The following concern acts as our importer in Europe, as defined in DECISION No 768/2008/EC.
 - Name: FURUNO EUROPE B.V.
 - Address: Ridderhaven 19B, 2984 BT Ridderkerk, The Netherlands
- InstantAccess bar is a trademark of FURUNO Electric Co., Ltd.
- All brand, product names, trademarks, registered trademarks, and service marks belong to their respective holders.
- Windows is a registered trademark of the Microsoft Corporation of the USA and other countries.

How to discard this product

Discard this product according to local regulations for the disposal of industrial waste. For disposal in the USA, see the homepage of the Electronics Industries Alliance (<http://www.eiae.org/>) for the correct method of disposal.

How to discard a used battery

Some FURUNO products have a battery(ies). To see if your product has a battery, see the chapter on Maintenance. If a battery is used, tape the + and - terminals of the battery before disposal to prevent fire, heat generation caused by short circuit.

In the European Union

The crossed-out trash can symbol indicates that all types of batteries must not be discarded in standard trash, or at a trash site. Take the used batteries to a battery collection site according to your national legislation and the Batteries Directive 2006/66/EU.

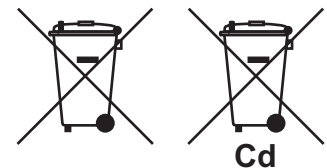

In the USA

The Mobius loop symbol (three chasing arrows) indicates that Ni-Cd and lead-acid rechargeable batteries must be recycled. Take the used batteries to a battery collection site according to local laws.

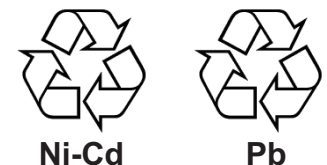



In the other countries

There are no international standards for the battery recycle symbol. The number of symbols can increase when the other countries make their own recycle symbols in the future.











SAFETY INSTRUCTIONS

The operator must read the safety instructions before attempting to operate the equipment.

 WARNING	Indicates a potentially hazardous situation which, if not avoided, could result in death or serious injury.
 CAUTION	Indicates a potentially hazardous situation which, if not avoided, could result in minor or moderate injury.

 Warning, Caution	 Prohibitive Action	 Mandatory Action
--	--	--

 WARNING	
	Do not open the equipment. This equipment uses high voltage that can cause electrical shock. Only qualified persons can work inside the equipment.
	Turn off power at switchboard if the something is dropped inside the equipment. Fire or electrical shock can result if the power remains on.
	Turn off power at switchboard if the equipment is emitting smoke or fire. Fire or electrical shock can result if the power remains on.

 WARNING	
	Do not disassemble or modify the equipment. Fire, electrical shock or bodily injury can result.
	Do not operate the equipment with wet hands. Fire or electrical shock can result.
	Keep the equipment away from areas where contact with water is likely. Fire or electrical shock can result if water gets into the equipment.
	Keep liquid-filled containers away from the equipment. Fire or electrical shock can result if a liquid spills into the equipment.

Warning Label

A warning label is attached to the Panel Computer Unit. Do not remove the label.

Panel Computer Unit rear

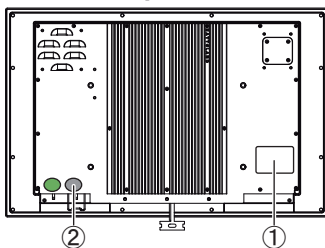



①		Name: Warning Label (1) Type: 86-003-1011-3 Code No.: 100-236-233-10	If the label is missing or damaged, contact your local dealer about replacement.
②		Name: Warning Label	Warranty is void if this label is removed.

TABLE OF CONTENTS

FOREWORD	xi
SYSTEM CONFIGURATION	xiv
1. INTRODUCTION	1-1
1.1 System Configuration	1-1
1.2 Panel Computer Unit	1-1
1.3 Trackball Control Unit	1-3
1.4 DVD Drive.....	1-3
1.5 How to Turn the Power On or Off.....	1-3
1.6 How to Select a Color Palette.....	1-4
1.7 How to Adjust the Display Brilliance	1-5
1.8 Silent Mode.....	1-6
1.9 How to Select Sensor Settings	1-7
1.10 How to Enter Ship Speed	1-8
1.11 How to Enter Heading	1-10
1.12 How to Mark MOB Position	1-11
1.13 How to Select Time Format, Set Local Time	1-12
1.14 How to Take a Screenshot of the Display	1-12
1.15 The Settings Menu	1-13
1.16 How to Manage User Profiles.....	1-13
1.16.1 How to create a profile	1-13
1.16.2 How to disable a profile	1-13
1.16.3 How to activate a profile	1-13
1.16.4 How to erase the settings for a profile.....	1-14
1.16.5 How to restore default settings to a profile	1-14
1.17 How to View ECDIS Software Version No., ECDIS System Information, and Operator's Manual	1-16
1.18 Split Screen	1-17
1.18.1 How to activate, deactivate the split screen	1-17
1.18.2 Function availability in split screen operation	1-18
1.18.3 Split screen usage characteristics	1-18
1.19 Tips.....	1-19
1.20 Printer Information	1-19
1.21 Keyboard	1-19
2. OPERATIONAL OVERVIEW	2-1
2.1 ECDIS Display.....	2-1
2.1.1 Electronic chart area	2-2
2.1.2 Status bar	2-5
2.1.3 InstantAccess bar™	2-7
2.1.4 Sensor information box	2-10
2.1.5 Own ship functions box	2-11
2.1.6 Route information box	2-12
2.1.7 Overlay/NAV Tools box	2-13
2.1.8 Alert box	2-13
2.1.9 Permanent warning box	2-13
2.1.10 EBL, VRM boxes	2-13
2.1.11 North mark.....	2-13
2.1.12 Context-sensitive menus	2-14
2.1.13 How to enter alphanumeric data	2-15
2.2 How to Select the ECDIS Operating Mode.....	2-17
2.3 How to Select the Chart Scale.....	2-18

TABLE OF CONTENTS

2.4	How to Select the Presentation Mode	2-19
2.5	Cursor Position Box	2-20
2.6	True Motion Reset.....	2-21
2.7	How to Control Route and User Charts in Voyage Navigation and Voyage Planning Modes	2-22
2.8	How to Use the VRM and EBL.....	2-23
2.8.1	How to hide/show an EBL, VRM	2-23
2.8.2	How to measure the range and bearing.....	2-23
2.8.3	How to select bearing reference	2-23
2.8.4	EBL, VRM functions available with the context-sensitive menu.....	2-24
2.8.5	How to select range calculation method	2-25
2.9	Datum.....	2-26
2.9.1	General	2-26
2.9.2	Paper charts.....	2-26
2.9.3	Electronic sea charts.....	2-26
2.9.4	Positioning devices and datum	2-26
2.9.5	ECDIS and datum	2-26
2.10	Set up Before Departure	2-27
2.10.1	Updates before departure	2-27
2.10.2	Create or update a route	2-27
2.10.3	How to check and prepare route, user chart to monitor.....	2-29
2.10.4	Check configuration of navigation sensors	2-32
2.10.5	How to reset odometer and trip meter.....	2-33
3.	HOW TO MANAGE CHARTS	3-1
3.1	How to Disable the C-MAP Chart Function.....	3-1
3.2	How to Install Public Keys for ENC Charts	3-2
3.3	How to Install ENC Licenses, Charts	3-3
3.3.1	How to install an ENC license	3-3
3.3.2	How to install ENC charts	3-4
3.4	How to Install ARCS Licenses, Charts.....	3-6
3.4.1	How to install an ARCS license.....	3-6
3.4.2	How to install ARCS charts	3-7
3.5	How to Delete ENC, ARCS Licenses.....	3-9
3.6	How to Update ENC Chart Manufacturer Info.....	3-9
3.7	How to Install C-MAP Charts	3-10
3.7.1	How to register the eToken.....	3-10
3.7.2	How to install the C-MAP database, licenses	3-11
3.7.3	How to generate, order and apply an update file	3-13
3.7.4	How to confirm license status	3-14
3.8	How to Delete a C-MAP Database.....	3-14
3.9	How to Export a List of Charts	3-14
3.10	How to Export a List of Specific Licenses	3-15
3.11	How to Show the ENC Permit, ARCS License.....	3-15
3.12	How to Backup, Restore Licenses	3-15
3.13	How to View Permit Expiration Date	3-16
3.14	How to Display Install/Update History	3-17
3.15	Catalog of Chart Cells	3-18
3.15.1	How to group chart cells.....	3-20
3.15.2	How to view status of chart cells	3-21
3.16	How to Open Charts.....	3-22
3.17	How to Print Chart List, Cell Status List	3-23
3.17.1	How to print the chart list.....	3-23
3.17.2	How to print the cell status list.....	3-24
3.18	How to Delete Charts	3-25
3.19	How to Show Publishers Notes for ENC Charts	3-25

3.20	How to Find the Chart Type.....	3-26
3.21	How to Update ENC, C-MAP Charts Manually.....	3-26
3.21.1	How to insert update symbols	3-27
3.21.2	How to copy objects from an official chart and insert them	3-28
3.21.3	How to ignore chart objects	3-28
3.21.4	How to delete (hide) a chart object.....	3-29
3.21.5	How to modify existing update symbols	3-29
3.21.6	How to review a chart object	3-29
3.21.7	How to remove all manual update data	3-30
3.22	How to Synchronize Chart Data	3-30
3.22.1	How to select the units to synchronize	3-31
3.22.2	How to check synchronization status	3-31
3.22.3	Manual updates and synchronization	3-32
3.23	How to Reconvert All SENC Charts	3-33
3.24	How to Manage Gate-1 Charts.....	3-33
3.24.1	How to select the chart type(s) to install.....	3-33
3.24.2	How to install charts and licenses	3-34
3.24.3	How to order licenses.....	3-34
3.25	How to Delete Chart Data.....	3-35
4.	HOW TO CONTROL CHART OBJECTS	4-1
4.1	How to Browse Your Charts	4-1
4.2	How to Control Visibility of Chart Objects.....	4-1
4.2.1	How to set value for shallow contour, safety depth, safety contour and deep contour	4-1
4.2.2	Basic Setting menu	4-3
4.2.3	Chart Display menu.....	4-4
4.2.4	Display base.....	4-5
4.3	How to Control Visibility of Symbols, Features.....	4-6
4.3.1	General page.....	4-6
4.3.2	Tracking page.....	4-7
4.3.3	Route page.....	4-9
4.3.4	Mariner page	4-10
4.3.5	Targets page	4-11
4.4	How to Control Predefined IMO Chart Display Settings	4-12
5.	VECTOR (S57) CHARTS.....	5-1
5.1	Introduction to S57 Charts.....	5-1
5.1.1	Definitions of terms.....	5-2
5.1.2	Chart legend for S57 charts	5-2
5.1.3	Permanent warnings for S57 charts	5-3
5.2	Chart Viewing Dates and Seasonal Features of the S57 Chart	5-4
5.2.1	Introduction.....	5-4
5.2.2	How to set Display Date and Update Review dates	5-4
5.2.3	About chart viewing date dependency of S57 standard	5-5
5.2.4	How to highlight updated data	5-6
5.3	Symbology Used in S57 Charts.....	5-7
5.3.1	Presentation library used for S57 chart features	5-7
5.4	How to Find Information for S57 Chart Objects.....	5-8
5.5	Admiralty Information Overlay (AIO).....	5-9
5.5.1	Installation	5-9
5.5.2	How to display the AIO.....	5-9
5.5.3	Catalog of AIO cells.....	5-10
5.5.4	How to find AIO chart object information	5-10
5.5.5	How to select the information to display	5-11

6.	RASTER (ARCS) CHARTS	6-1
6.1	ARCS Charts.....	6-1
6.1.1	Chart legend of ARCS chart.....	6-1
6.2	Datum and ARCS Charts	6-5
6.3	Permanent Warnings of ARCS	6-5
6.4	ARCS Subscriptions.....	6-6
6.4.1	ARCS Navigator.....	6-6
6.4.2	ARCS license information	6-6
7.	C-MAP BY JEPESEN CHARTS	7-1
7.1	How to Register the System at C-MAP	7-1
7.2	How to Order Charts	7-1
7.3	How to Apply for Licenses.....	7-1
7.4	Troubleshooting	7-2
7.5	Chart Display.....	7-2
7.5.1	Introduction	7-2
7.6	Permanent Warnings	7-3
7.7	Notice to Mariners (NM).....	7-4
8.	CHART ALERTS.....	8-1
8.1	Chart Alerts	8-2
8.1.1	How to set safety contour.....	8-2
8.1.2	How to select objects used in chart alerts.....	8-3
8.2	How to Activate Own Ship Check	8-4
8.3	Route Planning.....	8-5
8.3.1	Chart alerts for route planning.....	8-5
9.	ROUTES.....	9-1
9.1	Route Planning Overview.....	9-1
9.2	Main Menu for Route Planning.....	9-2
9.3	How Route Data is Synced	9-2
9.4	How to Create a New Route	9-3
9.4.1	How to use the Waypoints page	9-6
9.4.2	How to use the User Chart page.....	9-7
9.4.3	How to use the Optimize page.....	9-8
9.4.4	How to use the Alert Parameters page	9-9
9.4.5	How to use the Check Results page	9-10
9.5	How to Modify an Existing Route	9-11
9.5.1	How to change waypoint position.....	9-11
9.5.2	How to change other waypoint data	9-11
9.5.3	How to add a new waypoint at the end of a route	9-11
9.5.4	How insert a waypoint	9-12
9.5.5	How to delete a waypoint.....	9-12
9.5.6	Geometry check of route.....	9-12
9.6	SAR Operations	9-14
9.7	Route Bank	9-16
9.8	Route Optimization.....	9-18
9.8.1	Available route optimization strategies.....	9-18
9.8.2	How to optimize a route	9-18
9.8.3	How to plan a speed profile.....	9-20
9.9	How to Import Routes	9-20
9.9.1	How to import route data from another unit.....	9-20
9.9.2	How to import FEA-2x07 route data	9-21
9.9.3	How to import RTZ, CSV, ASCII format route data.....	9-21
9.10	How to Export Route Data	9-22
9.10.1	How to export FMD-3xx0 route data	9-22

9.10.2	How to export route data in FEA-2x07, RTZ, CSV, ASCII format	9-23
9.11	How to Delete Routes.....	9-23
9.12	Route Transfer Feature	9-24
9.12.1	How to turn route transfer on/off.....	9-24
9.12.2	How to send and receive monitored routes	9-25
9.12.3	How to send and receive planned routes	9-26
9.13	Reports.....	9-27
10.	USER CHARTS	10-1
10.1	Introduction.....	10-1
10.1.1	Objects of user charts	10-1
10.2	How User Charts are Synced.....	10-2
10.3	How to Create a User Chart.....	10-3
10.4	How to Edit Objects on a User Chart.....	10-7
10.5	How to Delete Objects from a User Chart	10-8
10.6	How to Copy a User Chart Object	10-8
10.7	How to Select the User Chart Objects to Display	10-9
10.8	How to Import a User Chart.....	10-9
10.8.1	User chart created on another unit.....	10-9
10.8.2	User chart created with ECDIS FEA-2x07	10-10
10.8.3	RTZ format user chart	10-10
10.9	How to Export a User Chart.....	10-11
10.9.1	User chart created on FMD-3x00	10-11
10.9.2	RTZ format user chart	10-11
10.10	How to Delete User Charts	10-12
10.11	User Chart Reports.....	10-12
10.12	How to Select the User Chart(s) to Use in Route Monitoring.....	10-16
11.	HOW TO MONITOR ROUTES.....	11-1
11.1	How to Start Route Monitoring	11-1
11.2	How to Stop Monitoring a Route (Manual, Auto).....	11-4
11.3	How to Select What Parts of a Route to Display	11-4
11.4	How to View Waypoint Information.....	11-5
11.5	How to View Linked User Chart Information.....	11-6
11.6	How to View User Chart Object Information in Route Monitoring.....	11-7
11.7	How to Change Monitored Route to Planned Route	11-7
11.8	How to Use Instant Track to Return to or Deviate from Monitored Route	11-7
11.8.1	Safe off track mode	11-8
11.8.2	Back to track mode.....	11-9
11.8.3	Instant track messages	11-11
11.8.4	Instant track details	11-12
11.8.5	How to monitor, stop monitoring an instant track	11-12
11.8.6	How to return to a monitored route when following an instant track route (safe off track mode only).....	11-14
11.8.7	Button label and equipment state.....	11-15
11.9	How to Share Route During Route Monitoring	11-16
12.	NAVIGATION TOOLS	12-1
12.1	How to Access the Tools in the Overlay/Nav Tools Box	12-1
12.2	Parallel Index (PI) Lines	12-2
12.2.1	How to activate, deactivate PI lines.....	12-2
12.2.2	PI line bearing reference	12-2
12.2.3	Number of PI lines to display.....	12-2
12.2.4	PI line mode	12-2
12.2.5	How to adjust PI line orientation, PI line interval	12-3
12.2.6	How to reset the PI lines	12-3

TABLE OF CONTENTS

12.2.7	How to adjust PI line length.....	12-4
12.3	Look-ahead	12-5
12.4	Ring.....	12-5
12.5	Predictor.....	12-7
12.6	Anchor Watch.....	12-8
12.7	UKC (Under Keel Clearance).....	12-9
12.7.1	UKC overview	12-9
12.7.2	How to set UKC.....	12-10
12.7.3	UKC window.....	12-10
12.8	Curved EBL.....	12-11
12.9	Mini Conning Display	12-11
12.10	Divider	12-12
12.10.1	How to use the divider.....	12-12
12.10.2	Usage characteristics, limitations.....	12-13
12.10.3	How to deactivate and erase the divider	12-13
12.10.4	How to select range calculation method	12-14
13.	TRACKED TARGET (TT) FUNCTIONS.....	13-1
13.1	How to Show, Hide TT	13-1
13.2	TT Symbols and TT Attributes	13-2
13.2.1	TT symbols.....	13-2
13.2.2	TT symbol color and size	13-2
13.3	How to Filter TT Targets	13-3
13.4	How to Set Vector Length and Vector Motion	13-4
13.5	How to Display TT Data	13-6
13.5.1	How to display target data for individual TT	13-6
13.6	Displaying Past Positions of TT	13-7
13.6.1	How to enable/disable the past position display, select past position reference.....	13-7
13.6.2	Past position point attributes	13-7
13.7	How to set the TT Source	13-8
13.7.1	TT source for configurations compliant with the latest regulations	13-8
13.7.2	TT source for non-compliant configurations.....	13-9
14.	AIS TARGET FUNCTIONS.....	14-1
14.1	Introduction	14-1
14.2	AIS Symbols.....	14-2
14.3	Voyage Data	14-5
14.4	How to Show, Hide AIS Targets.....	14-6
14.5	How to Filter AIS Targets	14-7
14.6	Activated Targets	14-8
14.7	Sleeping Targets	14-8
14.7.1	How to sleep an activated target.....	14-8
14.7.2	How to sleep all activated targets	14-8
14.8	How to Display AIS Target Data	14-9
14.9	Vector Length, Vector Stabilization in True Motion Mode	14-11
14.10	How to Display AIS Target Past Positions.....	14-12
14.10.1	How to enable/disable the past position display, set past position reference.....	14-12
14.11	TT, AIS Target Association.....	14-13
14.12	How to Display Own Ship Data	14-13
15.	AIS SAFETY, NAVTEX MESSAGES.....	15-1
15.1	AIS Safety Messages.....	15-1
15.1.1	How to send an AIS safety message	15-1
15.1.2	How to display received and sent AIS safety messages.....	15-2

15.1.3	How to delete a received or sent message	15-3
15.2	Navtex Messages	15-3
15.2.1	How to receive Navtex messages	15-4
15.2.2	How to delete received Navtex messages	15-5
16.	RADAR OVERLAY	16-1
16.1	Introduction	16-1
16.2	How to Activate, Setup the Radar Overlay	16-2
16.3	How to Adjust the Radar Signal Fed From the Radar Connection Box	16-3
16.4	Error Between Radar Echo Image and Chart	16-7
16.5	Error Sources for Radar Echo Image and TT Mismatch	16-8
17.	WEATHER OVERLAY	17-1
17.1	What is the Weather Overlay?	17-1
17.2	How to Activate, Deactivate the Weather Overlay	17-1
17.3	How to Select, Playback a Weather Data File	17-2
17.4	How to Set up the Weather Overlay	17-3
17.5	Weather Overlay Examples	17-5
17.5.1	Wind display	17-5
17.5.2	Temperature display	17-6
17.5.3	Cloud coverage display	17-6
17.5.4	Precipitation rate display	17-6
17.5.5	Waves display	17-7
17.5.6	Ocean current display	17-7
17.6	Weather Spot Information	17-8
17.7	Summary of Weather Overlay Viewability, Operability and Operating Mode	17-8
18.	NAVIGATION SENSORS	18-1
18.1	CCRS	18-1
18.2	How to Select Navigation Sensors	18-2
18.2.1	Sensors menu description	18-2
18.3	Source of Position	18-5
18.4	CCRP, Primary and Secondary Positions of Own Ship	18-6
18.5	Source of Navigation Data	18-7
18.6	Switching of Sensor and Indication	18-9
18.7	Filter Status	18-9
18.8	Position Alignment	18-11
18.8.1	How to align position	18-11
18.8.2	How to cancel position alignment	18-12
18.9	Wind Sensor	18-12
18.10	Depth Sensor	18-14
19.	RECORDING FUNCTIONS, PLAYBACK FUNCTIONS	19-1
19.1	How to Record User, Position Events	19-1
19.1.1	User events	19-1
19.1.2	Position events	19-2
19.2	Details Log	19-5
19.3	Voyage Log	19-6
19.3.1	How to set conditions for voyage logging	19-7
19.4	Chart Usage Log	19-8
19.5	Danger Targets Log	19-9
19.5.1	How to filter the dangerous targets log	19-10
19.6	Route Transfer Log	19-10
19.7	How to Playback the Log	19-12

TABLE OF CONTENTS

20. ALERTS	20-1
20.1 What is an Alert?	20-1
20.2 Alert Box.....	20-2
20.3 Aggregated Alerts	20-5
20.4 How to Temporarily Silence the Buzzer for an Alarm or Warning.....	20-6
20.5 How to Acknowledge an Alarm or Warning.....	20-6
20.6 Alert List	20-7
20.7 Alert Log.....	20-9
20.8 Alert Reception from Connected Sensors.....	20-10
21. PARAMETERS.....	21-1
21.1 Ship and Route Parameters.....	21-1
21.2 Forwarding Distances	21-2
21.3 Cost Parameters	21-3
21.4 Instant Track Parameters.....	21-4
22. SETTINGS MENU	22-1
22.1 How to Access the Settings Menu	22-1
22.2 File Export.....	22-2
22.3 File Import	22-3
22.4 File Maintenance.....	22-4
22.5 Alert Setting.....	22-5
22.6 Self Test.....	22-7
22.7 Data Sharing	22-8
22.8 Customize	22-9
22.9 Display Test	22-10
22.10 Keyboard Test.....	22-11
22.11 Screenshots.....	22-12
22.11.1 How to export screenshots.....	22-13
22.11.2 How to delete screenshots from the PCU	22-13
22.11.3 How to print screenshots.....	22-13
22.12 User Default.....	22-14
22.13 CCRP	22-15
23. MAINTENANCE AND TROUBLESHOOTING.....	23-1
23.1 Maintenance.....	23-1
23.2 Trackball Maintenance	23-2
23.3 Troubleshooting	23-3
23.4 Consumable Parts.....	23-4
23.5 Color Differentiation Test for S57 Charts	23-5
APPX. 1 MENU TREE	AP-1
APPX. 2 ABBREVIATIONS, SYMBOLS.....	AP-5
APPX. 3 DATA COLOR AND MEANING.....	AP-16
APPX. 4 ALERT LIST.....	AP-17
SPECIFICATIONS	SP-1
INDEX.....	IN-1

FOREWORD

Congratulations on your choice of the FURUNO ECDIS (Electronic Chart Display and Information System) FMD-3100. We are confident you will see why the FURUNO name has become synonymous with quality and reliability.

Since 1948, FURUNO Electric Company has enjoyed an enviable reputation for innovative and dependable marine electronics equipment. This dedication to excellence is furthered by our extensive global network of agents and dealers.

This equipment is designed and constructed to meet the rigorous demands of the marine environment. However, no machine can perform its intended function unless installed, operated and maintained properly. Please carefully read and follow the recommended procedures for operation and maintenance.

Features

The FMD-3100 is the product of FURUNO's extensive experience in computer technology and marine electronics. The ECDIS displays electronic charts, nav lines, TT targets, AIS targets and other navigation data on a high-resolution 24-inch display.

The main features of this ECDIS are

- Complies with IMO MSC.232(82), IMO A.694(17), IEC 61162-450 Ed. 1 AMD1, IEC 61174 Ed. 4, IEC 61162-1 Ed. 5, IEC 61162-2 Ed. 1, IEC 62288 Ed. 2, IEC 60945 Ed. 4.
- Continuous monitoring of ship's position through multi-sensor Kalman filter processing using GPS, DGPS, SDME.
- Route planning and route monitoring facilities.
- Radar image can be overlaid on electronic charts. (Requires FURUNO FAR-2xx7, FAR-2xx8, FAR-3xx0, FCR-2xx9 series radar.)
- Grounding warnings, safe depth contours.
- Chart database loaded and updated using DVD ROMs and other media.
- Target data from TT (Tracked Target) and AIS transponder to aid in collision avoidance.

Standards Used in this Manual

- The buttons on the InstantAccess bar and Status bar and menu items are shown in brackets; for example, the [PLAN] button.
- Context-sensitive menus are available with many buttons, boxes, and objects within the display area. Right-click those items to display the related context-sensitive menu.
- Unless noted otherwise, "click" means to push the left button on the Trackball Control Unit (in order to do a function).
- Unless noted otherwise, "keyboard" refers to the software keyboard. (A PC keyboard is optionally available.)

Program No.

ECDIS: 2450074-03.xx (xx=minor change)

Data protection scheme

Product	FMD-3100	
Software version	01.xx	03.xx
Testing Standard	IEC 61174 Ed. 3	IEC 61174 Ed. 4
Elec. Nav. Chart (ENC)	S-57 Ed. 3.1, S-57 Ed. 3.1.1, S-57 Maintenance Document (Cumulative) No.8	
Raster Nav. Chart (RNC)	S-61 Ed. 1.0	
ECDIS Presentation Library	S-52 PresLib Ed. 3.4	S-52 PresLib Ed. 4.0
ECDIS Color Scheme/Symbols	S-52 Ed. 6.0	S-52 Ed. 6.1
ENC Data Protection	S-63 Ed. 1.1.1	S-63 ed. 1.2.0
IHO CDS	S-64 Ed. 2.0.0	S-64 Ed. 3.0.1

You can find the latest ECDIS software maintenance on the internet, at the following address:
<http://www.furuno.com/en/merchant/ecdis/FMD-3100/#SoftwareVersion>

The latest IHO standard can be found at the following address: <http://www.iho.int>

Virus Prevention

The ECDIS is not equipped with a virus checker. The ECDIS operates in real time; therefore, having a virus checker that periodically checks the equipment for viruses would increase the processing load, which can affect operation. However, you can avoid viruses by following the instructions in this section.

When you update a chart

The PC and medium (USB flash memory, etc.) used to download and hold an update for an existing chart or a new chart may be infected with a virus. Check the PC and the medium for viruses with a commercial virus checker - BEFORE you connect them to the ECDIS. Be sure the virus checker contains the latest virus definition files. **Network connection**

The ECDIS receives and displays information from various navigation equipment and radar via a LAN. A PC and other equipment connected to a network can carry viruses. To prevent the introduction of a virus to the LAN, DO NOT connect the ECDIS or HUB to an external network, including other shipboard LAN.

Do not install 3rd part programs on the ECDIS

Do not install any 3rd party software.

Open source software

This product includes software to be licensed under the GNU General Public License (GPL), GNU Lesser General Public License (LGPL), BSD, Apache, MIT and others. The program(s) is/are free software(s), and you can copy it and/or redistribute it and/or modify it under the terms of the GPL or LGPL as published by the Free Software Foundation. Please access to the following URL if you need source codes: https://www.furuno.co.jp/en/contact/cnt_oss_e01.html

This product uses the software module that was developed by the Independent JPEG Group.

Reverse engineering

Reverse engineering (reverse assemble, reverse compiler) of the software of this equipment is strictly prohibited. However, reverse engineering is permitted under the following conditions:

- The library used for the reverse engineering (GNU Library General Public License Version 2, GNU Lesser General Public License Version 2.1, or later editions) is clearly noted.
- The reverse engineered software is used only within the scope outlined under the appropriate license.

CE/UKCA declaration

With regards to CE/UKCA declarations, please refer to our website (www.furuno.com), for further information about RoHS conformity declarations.

SYSTEM CONFIGURATION

Single workstation

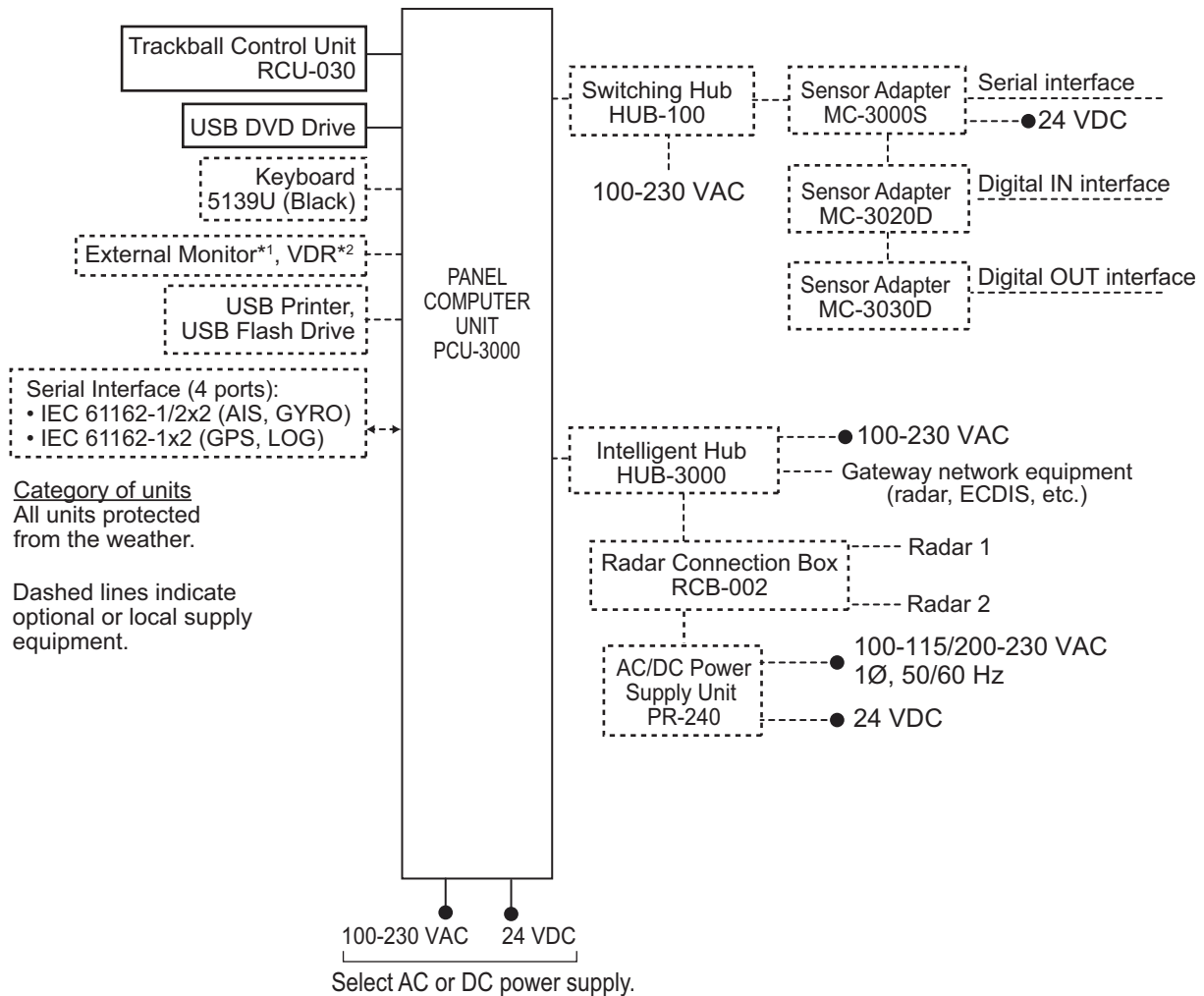

*1 Use full HD monitor or better.

*2 ECDIS picture data can be sent periodically to a VDR via LAN.

Connect the VDR to the LAN2 port on the Panel PC to send the data.

Multiple workstations (max. 3)

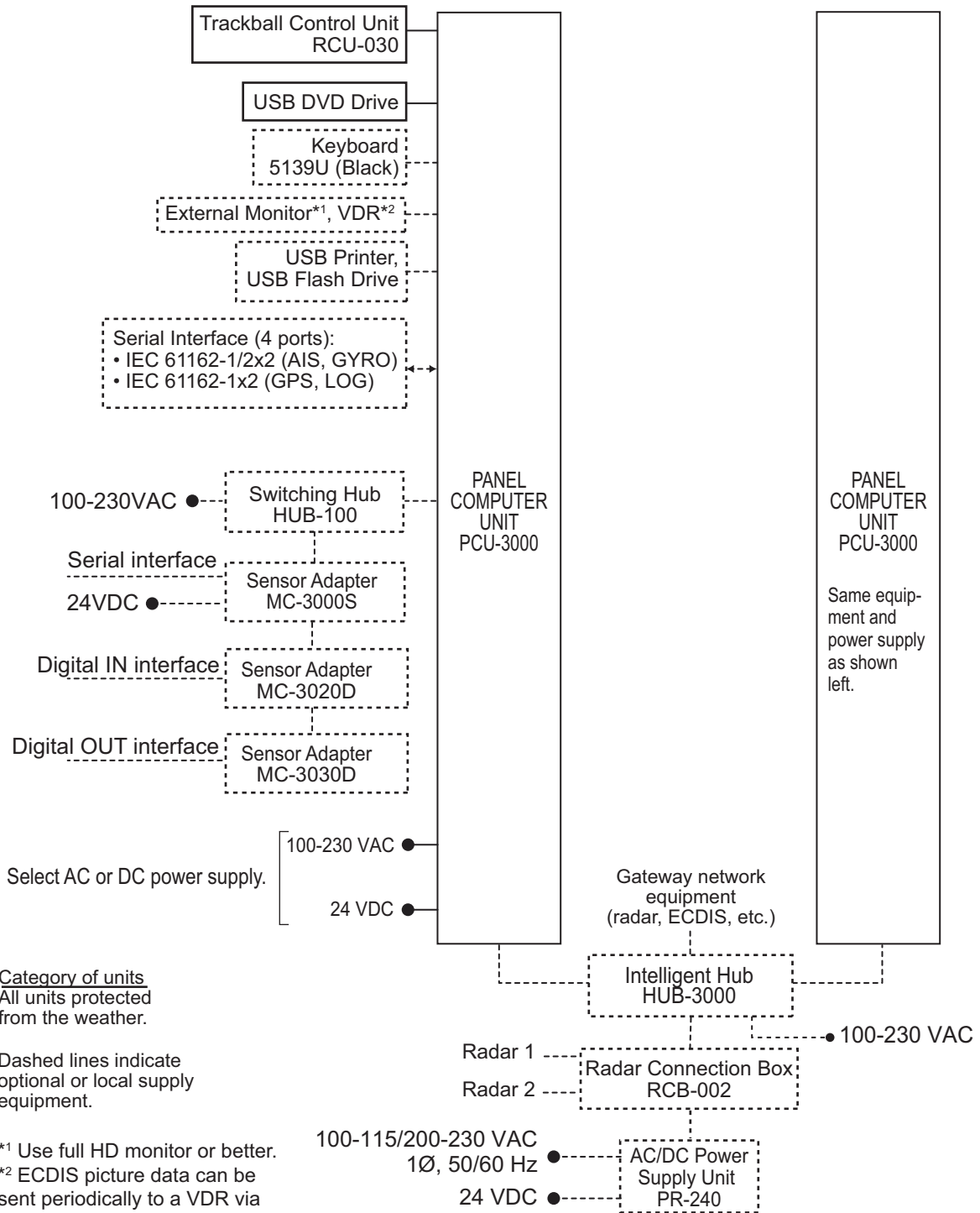

Category of units
 All units protected from the weather.

Dashed lines indicate optional or local supply equipment.

*1 Use full HD monitor or better.
 *2 ECDIS picture data can be sent periodically to a VDR via LAN. Connect the VDR to the LAN2 port on the Panel PC to send the data.

This page is intentionally left blank.

1. INTRODUCTION

1.1 System Configuration

The FMD-3100 mainly consists of the Panel Computer Unit (hereafter referred to as PCU) and Trackball Control Unit. The PCU is connected to various navigation sensors, and performs electronic chart operations, navigation calculations, route planning and route monitoring. The Trackball Control Unit selects items stored in the PCU and, subsequently, performs actions on those items. The optional Sensor Adapters interface between the PCU and external equipment to input and output information between the PCU and external equipment.

1.2 Panel Computer Unit

The 24" PCU is the heart of the ECDIS system, and is mainly responsible for chart management, route planning and route navigation.

Front panel

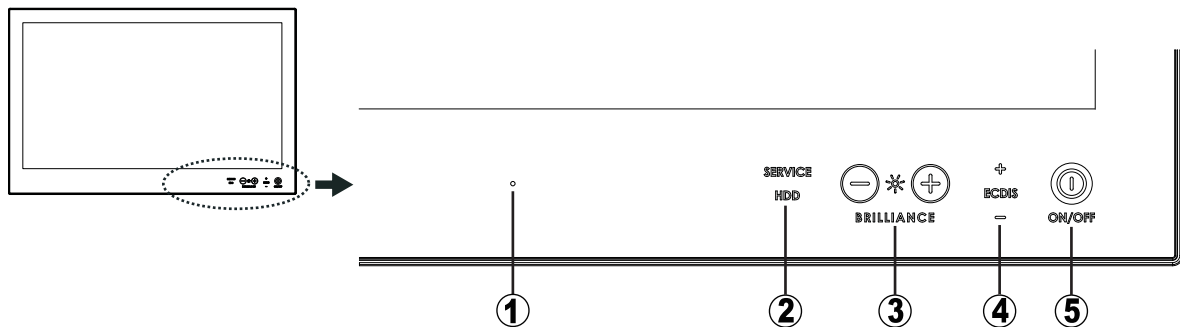

No.	Item	Description
1	Speaker	Outputs the audio alarm.
2	Equipment Status Indicator	"HDD" flashes in red when reading from or writing to the storage device. "SERVICE" illuminates in red when the unit requires service. (Have a FURUNO service engineer check the set.)
3	Brilliance Control	Adjusts the display brilliance. See section 1.7.
4	Brilliance Status	Indicates if the brilliance is within or outside of the ECDIS standard. See section 1.7.
5	Power Switch	Turns the power on or off. See section 1.5.

Note 1: To keep the system stable, restart the PCU at least once every two weeks.

Note 2: If the ambient temperature is less than 0°C(32°F) at start-up, the message "Low temperature detected, system preheat" appears, indicating the PCU is being warmed. The warming time varies with the ambient temperature, however the time is approx. 30 minutes. At the completion of the warming, the ECDIS display appears. No operation is possible until the warming is completed.

Note 3: Connect the USB DVD drive to the PCU only to do a chart, software update. After completion of an update, remove the medium from the drive, disconnect the drive from the PCU and store the medium in its case.

Note 4: The DVD ROM provided with this equipment contains the ECDIS program. Store the DVD in a place where the temperature and humidity are moderate. The recommended storage temperature is -10°C(14°F) to 40°C(104°F).

1. INTRODUCTION

Bottom panel

The bottom panel has connectors and ports for connection of external equipment. The USB ports, which carry USB 2.0 connectivity, are for connection of the Trackball Control Unit, USB DVD drive, designated keyboard and printer, mouse and USB flash memory. Do not connect other equipment to the USB ports.

A USB flash memory must be formatted to FAT32 to use it in the system.

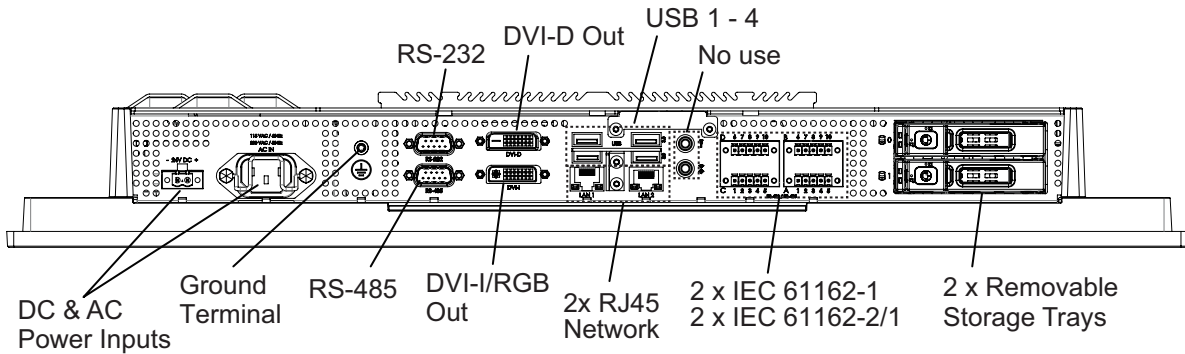

How to adjust the viewing angle

The viewing angle can be adjusted as shown in the illustration below

- 1** Pull and turn the locking pin clockwise to unlock it.

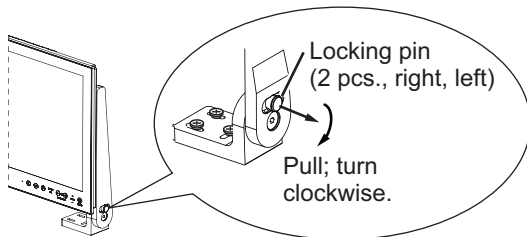

- 2** Tilt the display to desired angle.

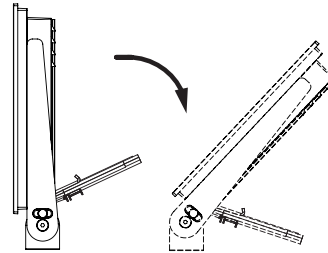

Note: When unlocking the bracket, hold the panel PC with both hands so the panel does not fall down.

- 3** Turn the locking pin counterclockwise and push it to insert it into the bracket. If the pin does not insert, tilt the display forward or backward slightly until you find the locked position.

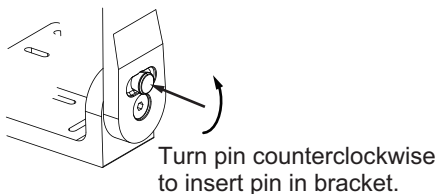

⚠ CAUTION



Make sure the locking pins are correctly inserted into the bracket.

The panel PC may fall if the pins are not correctly inserted, which may cause bodily injury or damage to the panel PC.

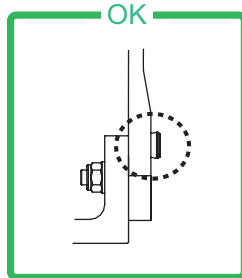

Locking pin correctly inserted.

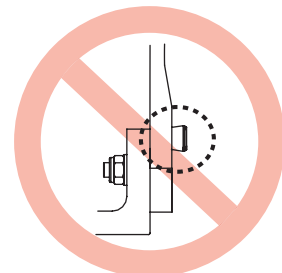

Locking pin not correctly inserted.

1.3 Trackball Control Unit

The Trackball Control Unit consists of a trackball, scrollwheel and left and right mouse buttons. You operate the unit just like a PC mouse; roll the trackball and operate the left and right buttons and the scrollwheel to do various functions.

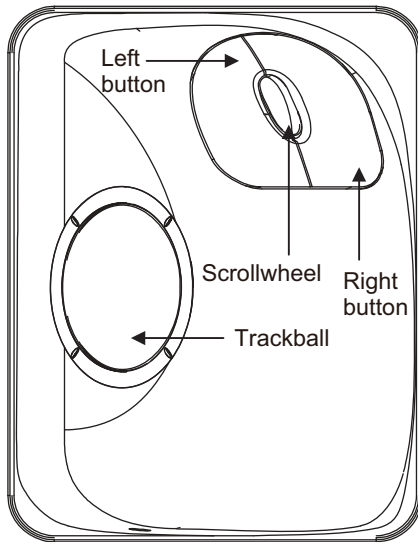

Left button

- Does the operation related to the object selected.
- Confirms the operation done for the object selected.

Scrollwheel

- Selects menu options.
- Selects chart scale.
- Sets numeric data.
- The scrollwheel does not have a “push” function.

Right button

- Displays context-sensitive menu when cursor is put in the display area.
- Cancels operation done on the object selected.

Trackball

- Moves the cursor.
- Selects an object.

Operator fitness

The operator fitness signal is output whenever the trackball, scrollwheel, right button or the left button is operated.

1.4 DVD Drive

A USB DVD drive is provided to upload chart data to the system.

The operating temperature range is 5°C(41°F) to 35°C(95°F).

Connect the end of the cable with the USB symbol to a USB port on the PCU. If the power from the USB port is insufficient, the power lamp on the drive flashes red. If this occurs, also connect the USB power connector cable (shown to the right) to the PCU to draw additional power.



USB power connector

1.5 How to Turn the Power On or Off

The power switch on the PCU illuminates in red when the power is connected and the PCU is turned off. To turn the power on, push the power switch until the lamp in the switch illuminates in green.

To turn the power off, press and hold down the power switch until the power goes off (approx. four seconds).

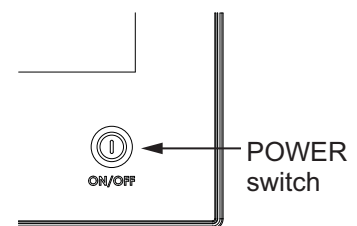

1.6 How to Select a Color Palette

The system provides six sets of preset color and brilliance combinations to match any ambient lighting condition. The specifications of each set are as shown in the table below.

Palette	Brilliance (%)*	Text color	Background color
Day-gray	97	White	Gray
Day-blue	97	White	Blue
Dusk-gray	68	Light gray	Dark gray
Dusk-blue	68	Light gray	Dark blue
Night-gray	49	Orange	Dark gray
Night-blue	49	Light gray	Dark blue

* Nominal brilliance values. Actual value may vary.

To select a palette, do the following:

1. Click the [Palette] button on the InstantAccess bar™.

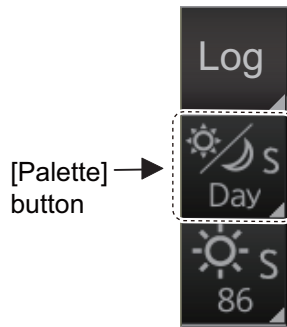

2. Select [Day], [Dusk] or [Night] as appropriate. For example, select [Day] to show its options.



3. Click the palette desired.

Note 1: If the display cannot be seen when switching from a Night to Day palette, push and hold the right button (approx. 2 seconds) to switch to the dusk-gray mode.

Note 2: The color palette setting may not get synchronized among ECDIS units selected for synchronization if a unit is being booted during the selection of the color palette. If this occurs, wait until all ECDIS units selected for synchronization have booted then reselect required color palette.

Note 3: The “S” or “L” at the right edge of the [Palette] button indicates color palette adjustment method, S for System, L for Local. See section 22.7 for details.

1.7 How to Adjust the Display Brilliance

Normally, the brilliance is automatically adjusted with the palette setting. However, the brilliance can also be adjusted manually. Operate the **BRILLIANCE** control at the bottom right corner on the PCU to adjust the brilliance. Push “+” to raise the brilliance; “-” to lower it.

The text "ECDIS" illuminates in green when the brilliance is within the ECDIS standard. "ECDIS" and the “+” or “-” symbol illuminate in red when the brilliance is higher or lower than the ECDIS standard. Adjust the brilliance to show "ECDIS" in green.

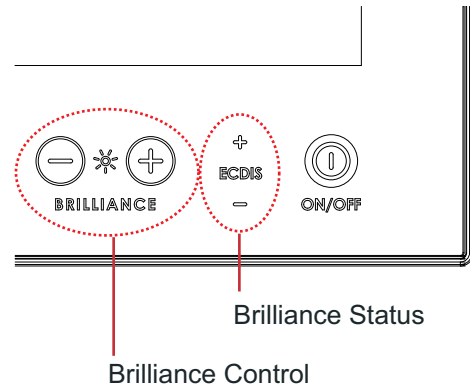

How to adjust the brilliance with the trackball control

Check that the brilliance status shows "ECDIS" in green before adjusting the brilliance.

1. Click the [BRILL] button () on the InstantAccess bar™ to show the brilliance adjustment window.

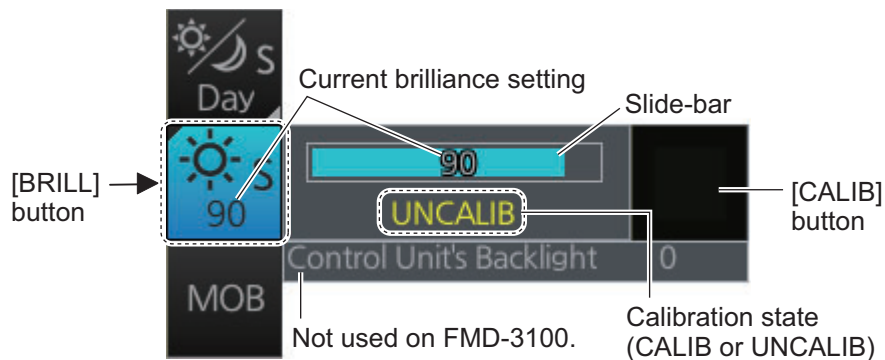

2. For coarse adjustment, place the cursor at the approximate location on the slide-bar where you want to set the brilliance, then click to change the brilliance. For fine adjustment, place the cursor on the slide bar, then spin the scrollwheel, or drag and drop the slide bar. When the brilliance settings is changed, the calibration state indication changes to "UNCALIB" (as shown in the figure above).
3. Click the [BRILL] button on the InstantAccess bar™ to close the brilliance adjustment window.

Note 1: To return the brilliance setting to factory default, at step 2 of the above procedure, click the [CALIB] button. The calibration state indication changes to "CALIB".

Note 2: The “S” or “L” at the right edge of the [BRILL] button indicates brilliance adjustment method, S for System, L for Local. See section 22.7 for details.

1.8 Silent Mode

The silent mode, which requires a password to activate, deactivates the audio alarms from the ECDIS. Use this mode when the ECDIS is not required, like in a harbor.

To go to the silent mode, first click the [OTHERS] button on the Status bar then click [SILENT]. Have the holder of the password enter the password then click the [OK] button.

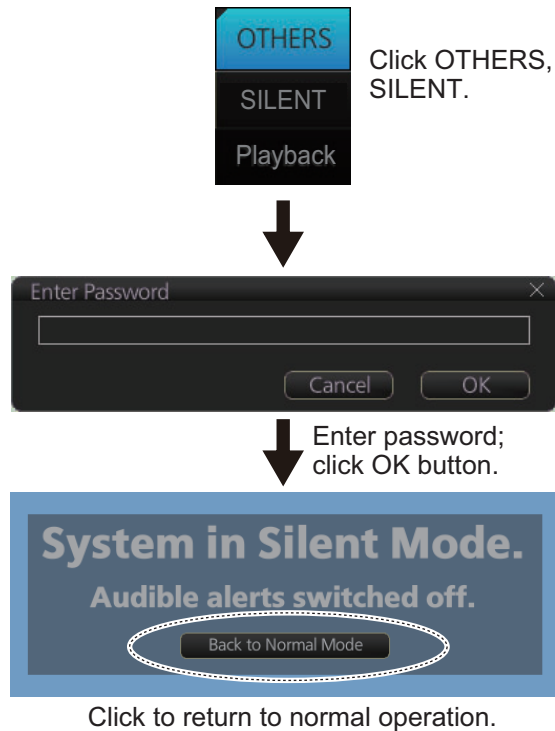

To return to normal operation, click [Back to Normal Mode].

1.9 How to Select Sensor Settings

This ECDIS system accepts navigation data input two ways: System or Local. System shares sensor data among multiple ECDIS in the network. Sensor priority is also commonly shared among the ECDIS. Local selects a sensor outside the network.

1. Right-click anywhere in the [Sensor information] box to show the context-sensitive menu.
2. Click [Local] or [System] as applicable.

Note: Sensor system can also be selected from the menu. Open the menu and click [System/Local Select] on the [Sensor] menu. Click the circle next to [System Sensor] or [Local Sensor] as appropriate then click the [Save] button.

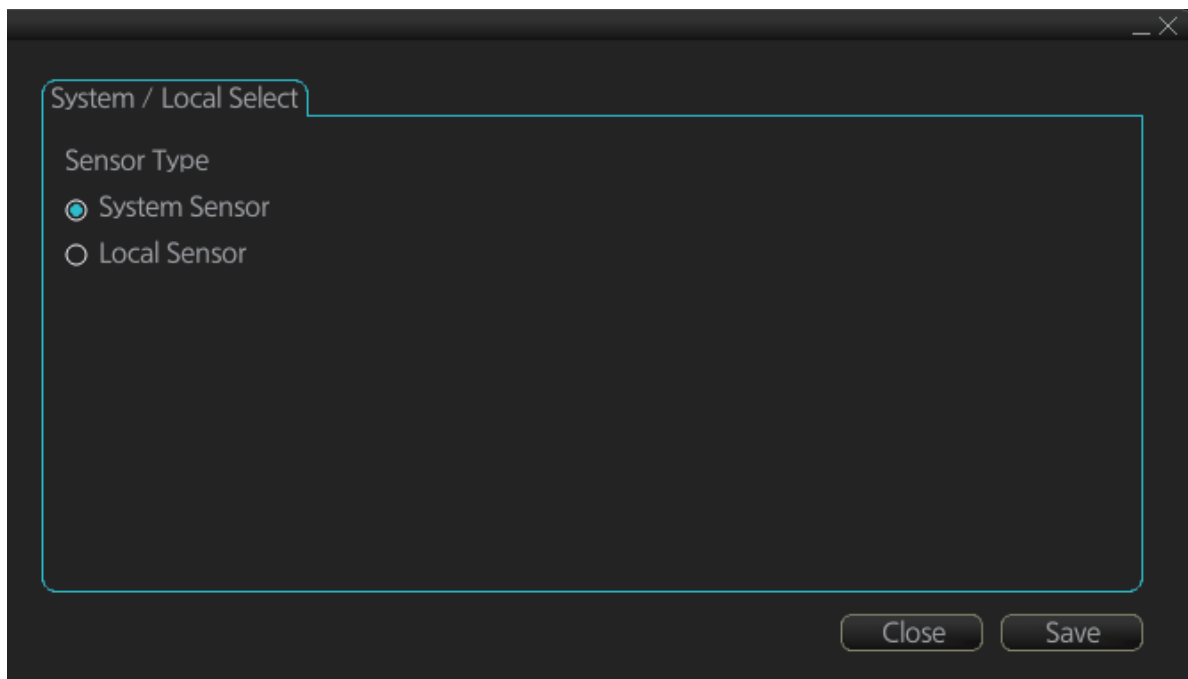
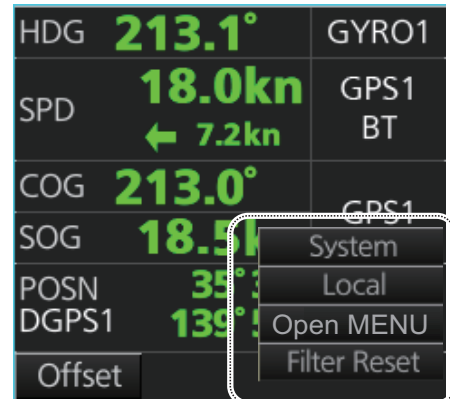

1.10 How to Enter Ship Speed

The speed can be entered from a log (STW) or GPS (SOG), or manually on the menu. Note that FURUNO GPS Navigator GP-150 provides both COG and SOG.

1. Right-click anywhere in the [Own ship information] box to show the context-sensitive menu.

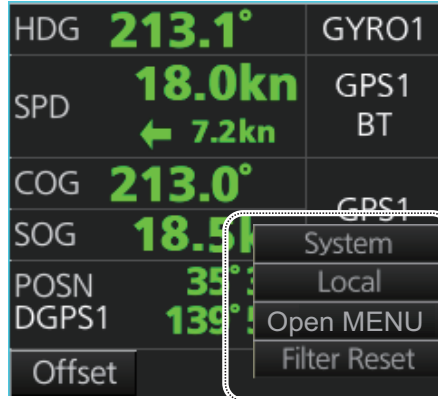

2. Click [Open MENU].
3. Click [System Sensor Settings] or [Local System Settings] as applicable.
4. Click the [SPD] tab.

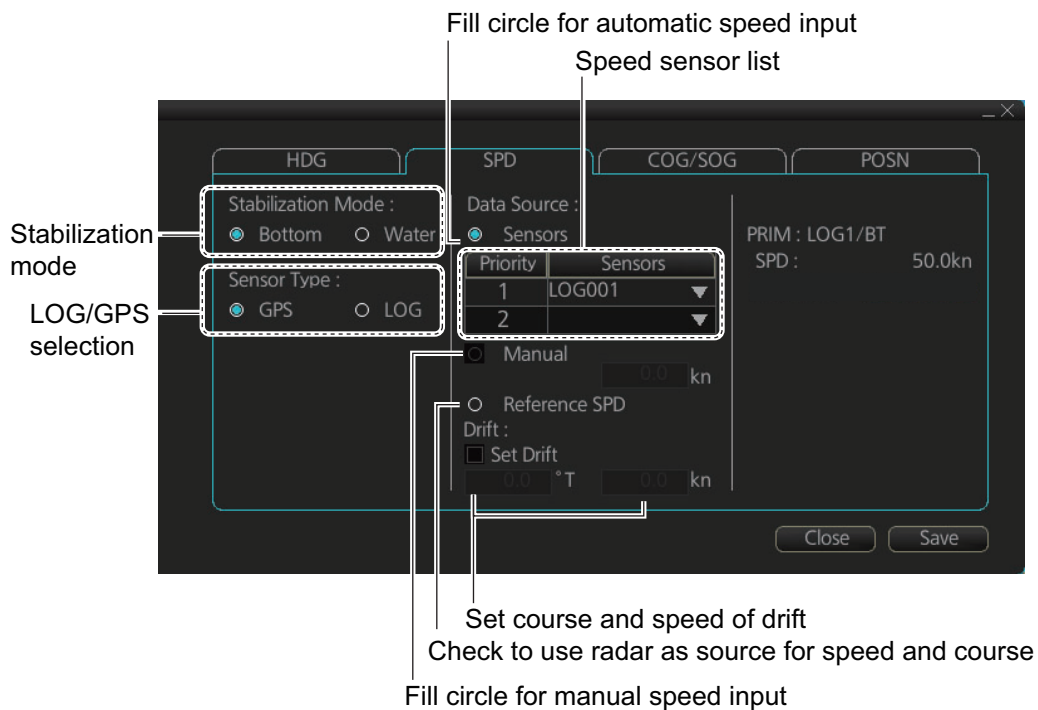

SPD page, local sensor

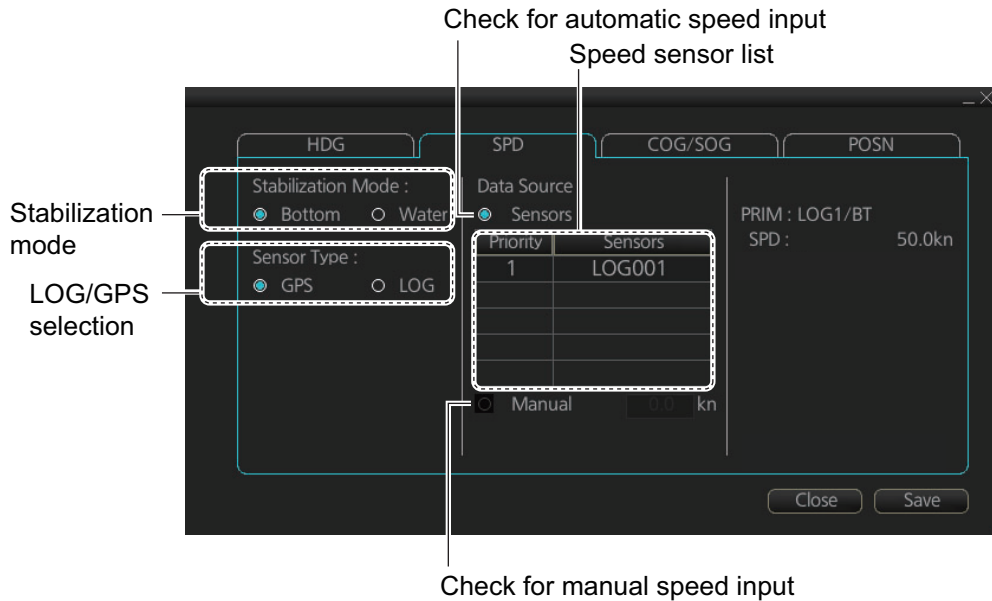

SPD page, system sensor

5. **For automatic input**, follow the procedure below. **For manual input**, go to step 6.
 - 1) Check [Sensors].
 - 2) Set the priority for the speed sensors in case of Local sensor. Click the triangle on the Priority1 line to select the sensor to be the Priority1 sensor. Do the same for the Priority2. Only one sensor can be Priority1; all others are priority 2. If a speed sensor is changed from Priority2 to Priority1, then that sensor previously selected to Priority1 is then automatically selected to Priority2 state.
 - 3) Check [LOG] or [GPS] at [Sensor Type] as appropriate.
 - 4) Select [Bottom] or [Water] at [Stabilization Mode]. Select [Bottom] if GPS is the source of speed data, or [Water] if a speed log is the source of speed data.
 - 5) Go to step 7.
6. For manual input, set the stabilization mode for [Water] and check [Manual]. Enter the speed, using the scrollwheel or software keyboard.

Note: For set and drift, see page 18-4.
7. Click the [Save] button to save settings then click the [Close] button to close the menu.

Notes on speed input

- Be sure not to select a LOG option when a speed log is not connected. If the log signal is lost, the GPS sensor is used. In the event of GPS loss, the SPD is shown as "***.* kn".
- The SPD is shown as "***.* kn", and the label "LOG" is erased if no log signal is present for a certain amount of time. The timeout varies according to ship.
- If SOG is changed to STW, the label "LOG" (in orange) appears. If log signal is lost "LOG" is colored yellow.
- A single-axis water log cannot measure speed when the wind is coming from the leeway direction.

1.11 How to Enter Heading

Heading can be entered manually or automatically.

Note: When the vessel is in high latitudes (over 85°), data from the gyrocompass is not used. The internal filter data is used for heading calculation. In this case, the heading source in the sensor information box appears as "FILT".

1. Right-click anywhere in the [Sensor information] box to show the context-sensitive menu.
2. Click [Open MENU].
3. Click [System Sensor Settings] or [Local System Settings] as applicable.
4. Click the [HDG] tab.

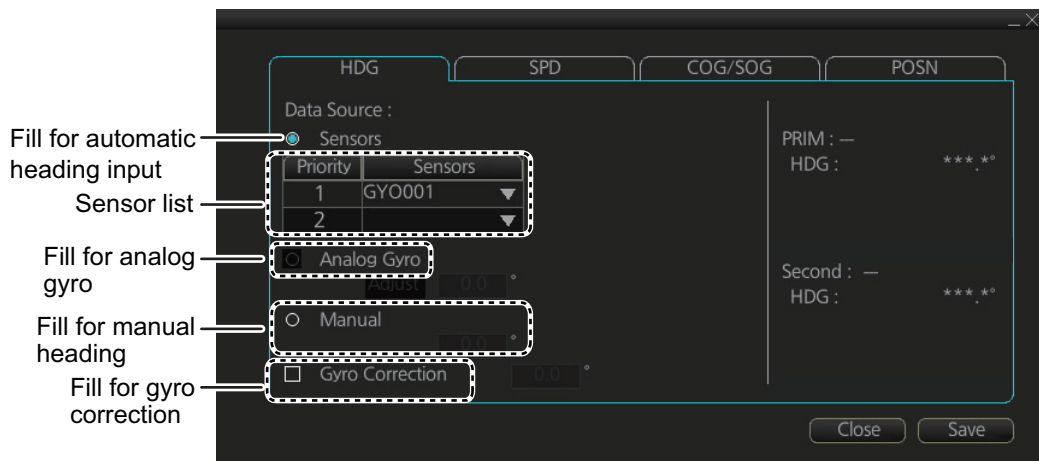
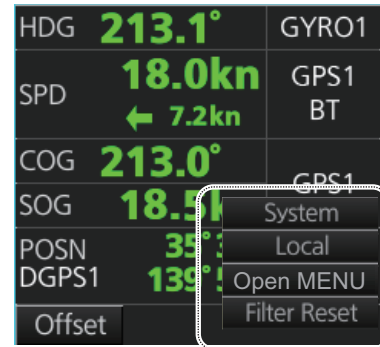

Local sensor settings

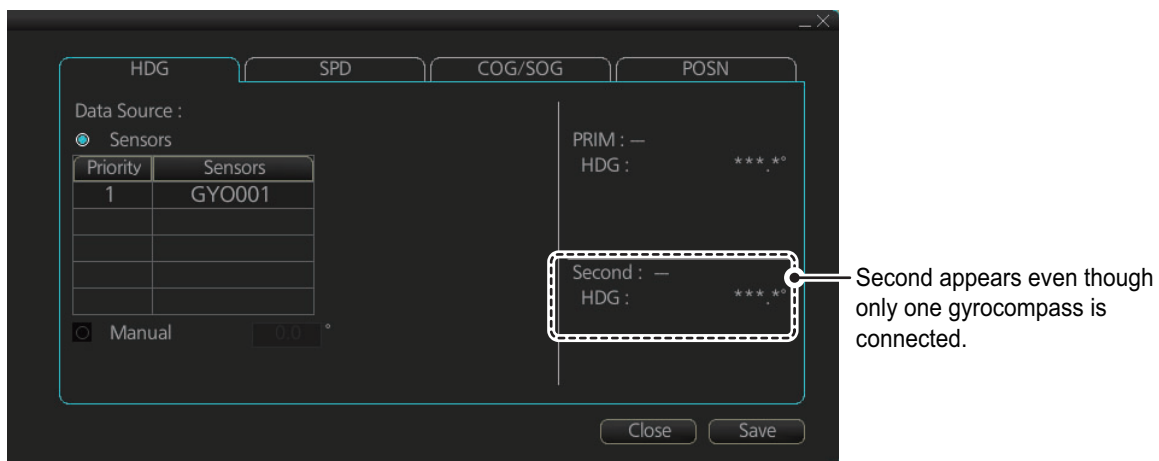

System sensor settings

5. For automatic input follow the procedure below. For manual input, go to step 6.
 - 1) Check [Sensors].
 - 2) For local system settings, set the priority for each sensor connected, referring to section 1.10.
 - 3) Go to step 7.

Note: For the local sensor, an offset can be applied to the gyro reading if it is wrong. Check [Gyro Correction], then spin the scrollwheel to set the offset.
6. For manual input, check [Manual]. Enter heading by spinning the scrollwheel or entering numeric data with the keyboard on the Control Unit.
7. Click the [Save] button to save settings then click the [Close] button to close the menu.

1.12 How to Mark MOB Position

Use the MOB (man overboard) feature to mark the position of man overboard on the display screen. Access the [MOB] button (in any mode) on the InstantAccess bar™.

The MOB mark instantly appears at the system position of your ship when the button is operated.



MOB

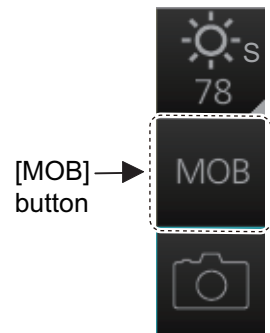

Up to 100 MOB marks can be saved. When the capacity for MOB marks is reached, the oldest mark is automatically erased to make room for the latest.

To hide an MOB mark, get into the Navigation voyage mode (NAVI) or Voyage planning mode (PLAN) right-click the mark to show the context-sensitive menu then select [Hide MOB].

Exercise caution when using this feature in strong tide or current. The person will not be at the MOB position for a very long time.

How to find MOB information

In an ECDIS mode other than Chart maintenance, put the cursor on a MOB mark and click. Text can be entered in the [MOB Description] window. Click the [OK] button to save the text and close the window.

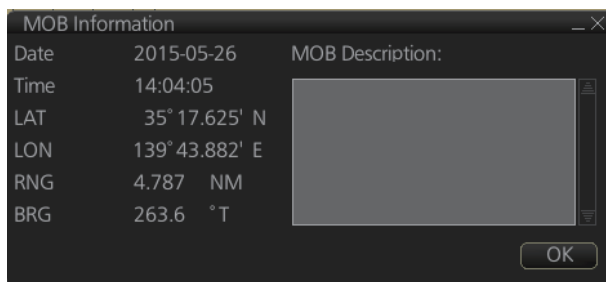

1.13 How to Select Time Format, Set Local Time

A GPS navigator feeds time and date data to the ECDIS and they appear on the Status bar. Neither the time nor the date can be adjusted, however you can select between UTC time (default) and local time. You can switch between the local time and the UTC time by left-clicking the Current time format indication.

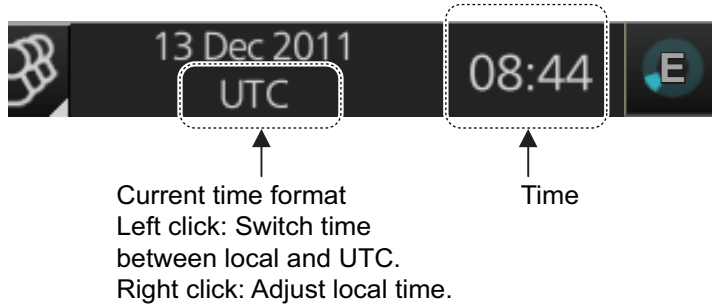

To set the local time, enter the time difference between the local time and the UTC time as shown below.

1. Right-click the Current time format indication to show the context-sensitive menu then click [Adjust Local Time] to display the [Local Time Adjust] dialog box.

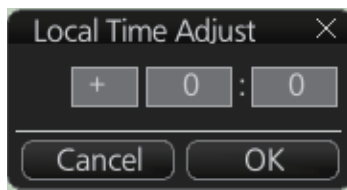

2. Enter the time difference between the local time and the UTC time, in hours and minutes. Use the button on the left to select the time offset direction. Select "+" if the local time is ahead of the UTC time, or "-" if it is behind the UTC time.

1.14 How to Take a Screenshot of the Display

Click the [Capture] button on the InstantAccess bar™ to take a screenshot and save it to the SSD (Solid State Drive). You can save a maximum of 100 screenshots. When the memory for screenshots becomes full, you cannot take any more screenshots. In this case, delete unnecessary screenshots. You cannot take a screenshot when a menu or a dialog box is open. Screenshots can be copied to a USB flash memory. For how to process screenshots, see section 22.11.

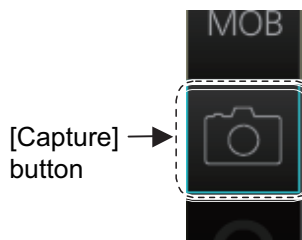

1.15 The Settings Menu

The [Settings] button gives you access to the user profiles and the [Settings] menu. The [Settings] menu has facilities for screenshot management, file management, diagnostic tests and customizing. See chapter 22.



1.16 How to Manage User Profiles

Ten sets of [Chart Display], [Symbol Display] and [Chart Alert] menu settings can be stored in user profiles for later retrieval.

1.16.1 How to create a profile

1. Set the [Chart Display], [Symbol Display] and [Chart Alert] menus as desired.
2. Click [⚙] on the Status bar then click [Manage Profile].
3. Select a profile number from the "Profile" drop-down list.

Note: Profiles 06-10 are disabled in the default setting. To enable a disabled profile, select the profile to enable from the "Profile" drop-down list then uncheck [Disable this profile].

4. Click [Save Current Settings].

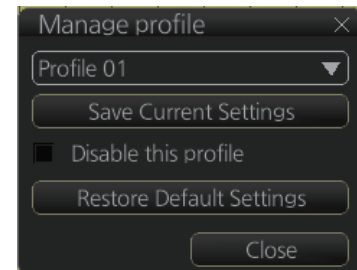

1.16.2 How to disable a profile

1. Click [⚙] on the Status bar then click [Manage Profile].
2. Select a profile number from the "Profile" drop-down list.
3. Check [Disable this profile].

The profile enabled at section 1.16.3 cannot be disabled.

1.16.3 How to activate a profile

1. Click [⚙] on the Status bar then click the profile number to activate.
2. Click the profile number you wish to activate. The confirmation message "Settings will be changed to Profile xx. Do you wish to continue?" appears.
3. Click [Yes] to activate the selected profile. Click [No] to cancel.

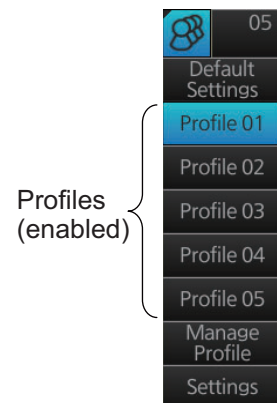

1.16.4 How to erase the settings for a profile

1. Click  on the Status bar then click [Manage Profile].
2. Select a profile number from the “Profile” drop-down list.
3. Click [Clear Profile].
The confirmation message "This profile will be cleared. Do you wish to continue?" appears.
4. Click [Yes] to clear all settings for the selected profile. Click [No] to cancel.

1.16.5 How to restore default settings to a profile

1. Click  on the Status bar.
2. Click [Default Settings].
The confirmation message "Settings will be changed to the default. Do you wish to continue?" appears.
3. Click [Yes] to clear all settings for the selected profile. The settings on the following table are changed to the recommended settings.

Note: After restoring default settings, some alerts will change to "not generated" state. To restore the previous state, restart the system.

Item		Settings
[Route Information] menu		
Route information page	unit of “XTD”	m
[System Sensor Settings]/[Local Sensor Settings] menu		
SPD page	Stabilization Mode	Bottom
[Other Sensor Settings] menu		
Other Sensor page	Wind	m/s
[Basic Setting] menu		
Basic Setting page	TM Reset	90%
[Chart Display] menu		
General page	Symbols	Paper Chart
	Boundaries	Plain
	Four Shades	Unchecked
	Full Light Lines	Unchecked
	Scale MIN	Unchecked
	Shallow Pattern	Unchecked
	Shallow Water Dangers	Checked
	Unknown	Checked
	Accuracy	Unchecked
	Highlight Date Dependent	Unchecked
	Highlight INFO	Unchecked
	Highlight Document	Unchecked
	Contour Labels	Unchecked
LAT/LON Grid	Unchecked	
Text page	Important Text	Checked
NtoM page	Temporary Notices	Unchecked
	Preliminary Notices	Unchecked
	No Information	Unchecked

Item		Settings
[Symbol Display] menu		
General page	Ship Outlines	OFF
	AIS Outlines	OFF (grayed out)
Tracking page	CCRP	Checked
	Primary	Checked
	Secondary	Checked
	Pivot	Checked
	Length	720 min
	Labels	30 min
Mariner page	Labels	Checked
	Lines	Checked
	Clearing Lines	Checked
	Tidals	Checked
	Areas	Checked
	Circles	Checked
[Chart Alert] menu		
Chart Alert page	Safety Contour	Keeps previous setting
	Safety Depth	Keeps previous setting
	Safety Contour check box	Checked
	Dangerous or special areas *	Checked
	Navigational Hazard check box	Checked
	Navigation Hazard Alert level	C (Caution)
[TT/AIS]-[Setting] menu		
Setting page (AIS DISP Filter)	Physical AtoN	ON
	Virtual AtoN	ON
	MAX Range	ON, 6 NM
Setting page (TT DISP Filter)	MAX Range	ON, 6 NM
Chart scale/presentation mode box		
Chart scale		3 NM
Presentation mode		North Up TM
[Overlay/NAV Tools] box		
Look-ahead page	Ahead	Time, 6 min
Echo page	Display	OFF
TT/AIS page	TT display	OFF
	AIS display	OFF
	Vector	6 min, T.GND
	Past POSN	OFF
Other functions		
Brilliance		CALIB
Viewing Date - Display Date		Auto: Today
Split Screen		Full Screen (no split)
Chart database mode		CUSTOM
TM Reset function		Enabled
Own track		Disabled
Log - NAV Log - Detail dialog		Show Track

*: Chart alert objects other than Safety Contour, No Vector Chart, Sounding UKC Limit, Not up-to-date, Navigational Hazard, UKC Limit, Non-official ENC, Permit Expired.

1.17 How to View ECDIS Software Version No., ECDIS System Information, and Operator's Manual

You can show ECDIS program no., ECDIS system information, and the operator's manual. Click the [?] button on the Status bar then select [Manual] to show the operator's manual, or [About] to show ECDIS and system related information.

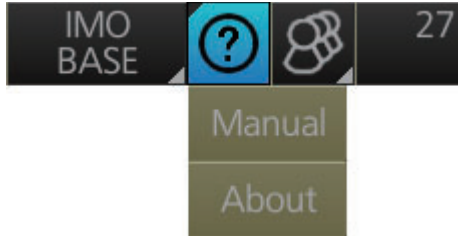

[Manual] shows the Operator's Manual.

[About] shows the system information, prepared in four tabs.

- [Version]: Shows the ECDIS software version no., S52 presentation library version, ENC user permit no., and C-MAP SDK software version no.
- [System 1]: Shows ECDIS system information: CPU type, RAM capacity, SSD free/ SSD capacity, Equipment ID and dongle information. [Function] shows this unit's capabilities.
- [System 2]: Shows the startup time of the current session
- [Applied Standards]: Shows the IEC standards that the system conforms to.

The information shown may be different than what appears on your display.

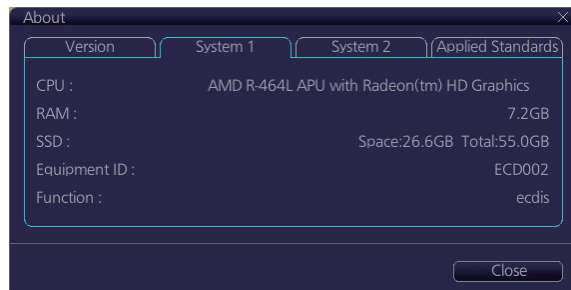
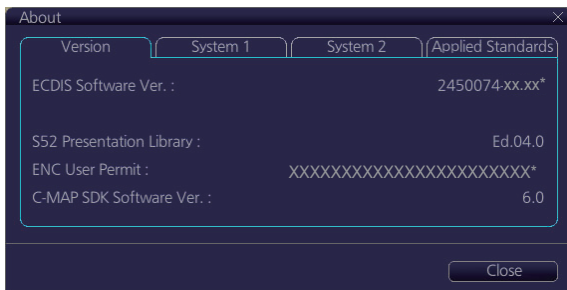

*: Actual permit/version number appears here.

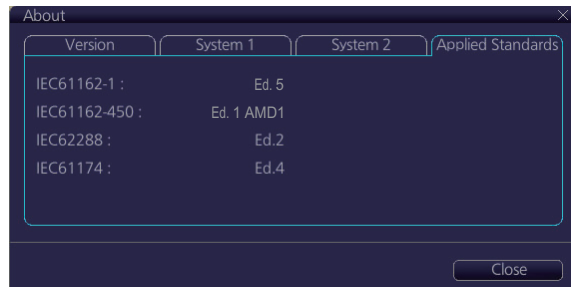
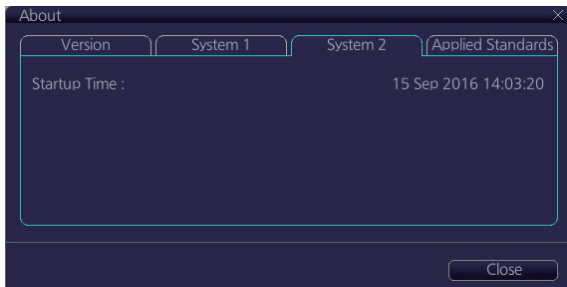

1.18 Split Screen

You can split the screen in two, horizontally or vertically, in the Voyage navigation mode.

1.18.1 How to activate, deactivate the split screen

To activate the split screen or return to the full screen, click the [DISP] and [TWO DISP] buttons on the InstantAccess bar™ to show the choices for screen division. Click the screen division desired.

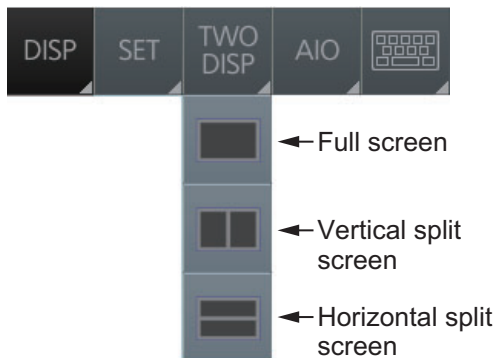

The example below shows the vertical split screen. The active display can be switched by clicking an [ACTIVE] button at the top of the display. The dividing line between the main and sub views cannot be moved.

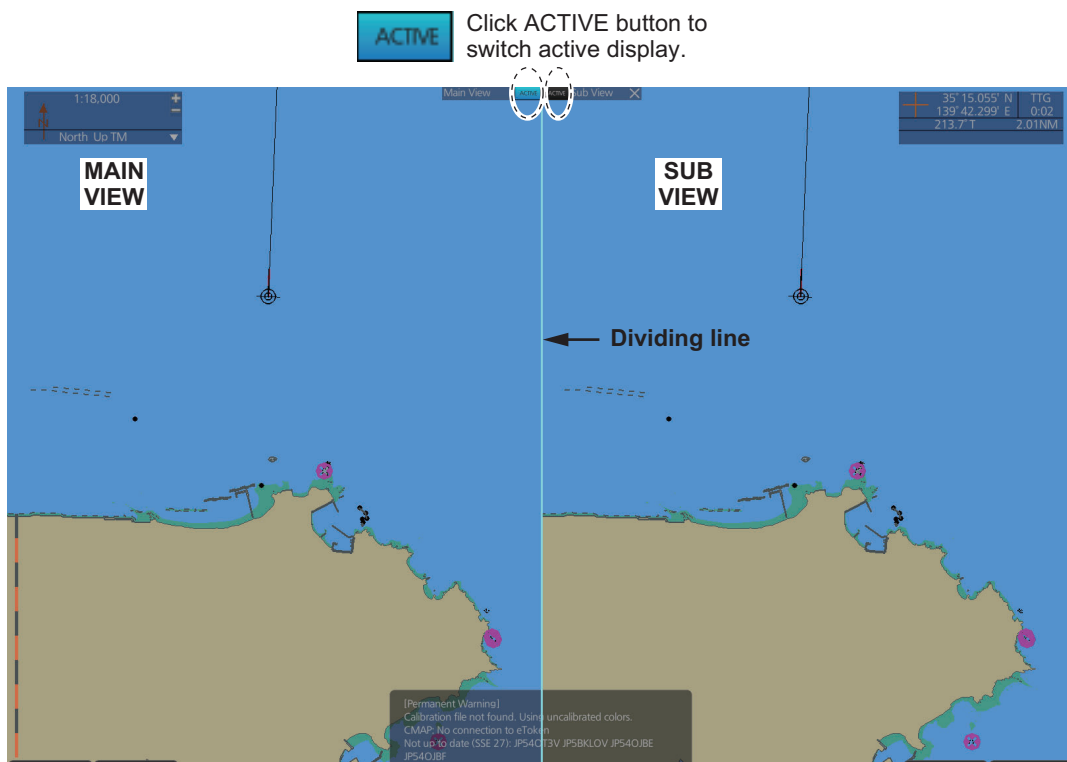

1.18.2 Function availability in split screen operation

Item	Viewable		Operable	
	Main view	Sub view	Main view	Sub view
AIS target	Yes	Yes	Yes	Yes
Anchor watch	Yes	Yes	Yes	No
Chart display	Yes	Yes	Yes	No
Danger highlight	Yes	Yes	Yes	No
Divider	Yes	Yes	Yes	No
EBL, VRM	Yes	Yes	Yes	Yes
Parallel index lines	Yes	Yes	Yes	Yes
Radar overlay	Yes	No	Yes	-
Range rings	Yes	Yes	Yes	No
TT	Yes	Yes	Yes	Yes
Weather display	Yes	No	Yes	-

1.18.3 Split screen usage characteristics

- If the sub view is not displayed correctly, restore the full screen display then try to activate the split screen again.
- The display may not be updated when switching to the Voyage planning mode. If this occurs, switch to the Voyage navigation mode, restore the split screen display then return to the Voyage planning mode.
- The own ship mark may not appear when releasing the split screen display. If this occurs, click the indication "TM/CU Reset" at the top right position on the screen to show the own ship mark (at the screen center).
- The TM reset feature only works on the active display. To return the own ship mark to the screen center, click the indication [TM/CU Reset] at the top right position on the screen.
- The sub view can use a location and chart scale different from the main view.
- The chart scale related messages (overscale, larger ENC available, etc.), which appear beneath the chart scale indication, show only on the main view.

1.19 Tips

This ECDIS provides operational tips for the display area and the InstantAccess bar™. To get a tip, simply put the cursor on an object. The tip appears to the right of the object. For example, put the cursor on the [BRILL] button on the InstantAccess bar™. The tip "Adjust brilliance" appears.



1.20 Printer Information

A Hewlett Packard (HP) printer may be connected to the system to print ENC Publisher's Notes, reports, logs, etc. The available HP printers are Officejet Pro 8000, Officejet Pro 8100, HP Officejet Pro 8210, HP Officejet 100 Mobile and HP Officejet 200 Mobile. No other makes or models are permitted.

1.21 Keyboard

An optional keyboard is available for entry of data. The following keys are inoperative:

- Prt Scr/SysRq key
- Pause/Break key
- Insert (NumLk key operative)
- ScrLk (Delete key operative)
- PageUp key
- PageDown key
- Alt key
- Windows key
- Application key

1. INTRODUCTION

This page is intentionally left blank.

2. OPERATIONAL OVERVIEW

2.1 ECDIS Display

The ECDIS (Electronic Chart Display and Information Systems) screen is divided into several areas, as illustrated below. The ECDIS operational area has no limitations. That is, high latitudes (85° and higher) are correctly displayed always. The ECDIS uses “orthographic” projection for areas of high latitude and small chart scales. All other conditions use the “cylindrical equidistant” presentation.

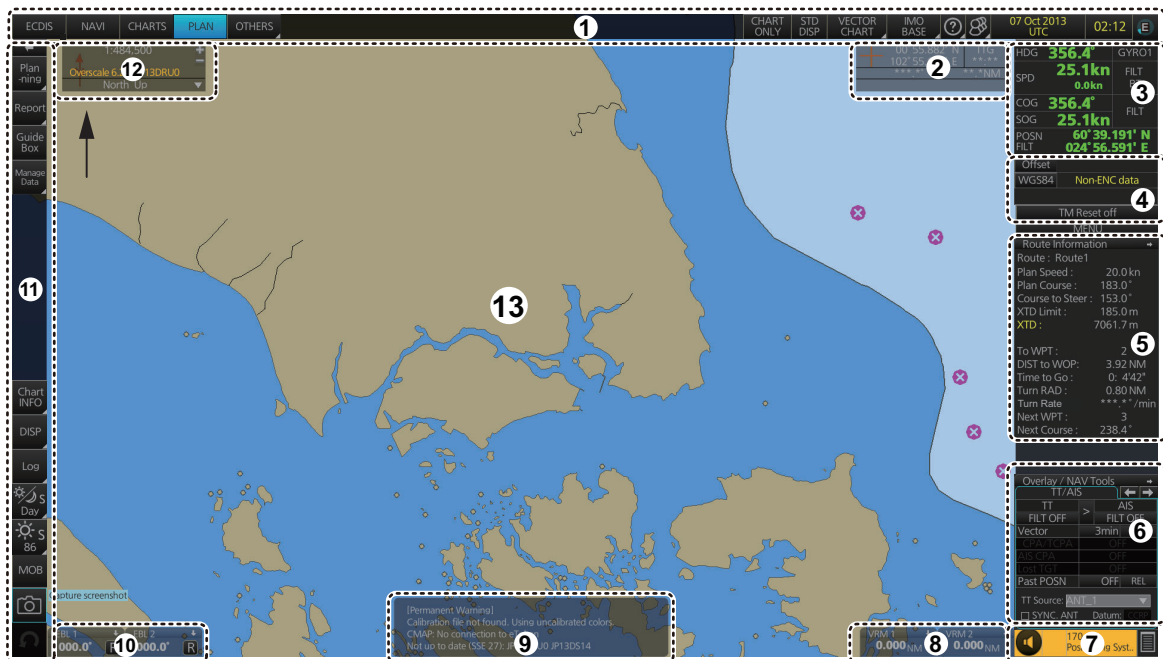

No.	Name	Description
1	Status bar	Provides for selection of operating mode, chart format, etc.
2	Cursor position box	Shows the latitude/longitude position of the cursor and TTG to the cursor.
3	Sensor information box	Displays ship's speed, course and position and selects sensors.
4	Own ship functions box	Applies offset to the chart; changes geodetic data system, and provides true motion reset.
5	Route information box	Shows route and waypoint data, when a route is selected for navigation.
6	Overlay/NAV Tools box	Provides for setup of the radar overlay and navigation-related functions.
7	Alert box	Shows operational and system alert messages.
8	VRM boxes	Measure the range to an object.
9	Permanent warning box	Displays chart-related warning messages.
10	EBL boxes	Measure the bearing to an object.
11	InstantAccess bar™	Provides quick access to functions such as brilliance adjustment, display palette and the menu. The contents of the upper part of the bar change according to the ECDIS mode selected.

2. OPERATIONAL OVERVIEW

No.	Name	Description
12	Chart scale/presentation mode box	Selects the chart scale and presentation mode.
13	Electronic chart area	Shows the ECDIS chart.

Note: If the display indications freeze (because of ECDIS error, etc.), the buzzer sounds continuously. Restart the system to restore normal operation.

2.1.1 Electronic chart area

The ECDIS can use the following types of charts:

- S-57 (IHO)
- S-63 (IHO) (S-63 encrypted)
- ARCS (UKHO)
- C-MAP

The following information can also be displayed:

- Cursor (moved by trackball)
- Planned route
- EBL (Electronic Bearing Line) and VRM (Variable Range Marker)
- Radar image
- Own ship symbol with speed vector
- TT (Tracked Target, acquired from radar)
- AIS target

Electronic charts in ECDIS

The electronic navigational charts are displayed in the electronic chart area. There are two kinds of electronic navigational charts available for use in the ECDIS:

- Vector format (ENC or C-MAP)
- Raster format (ARCS)

The ECDIS combines chart and navigational information. It should be noted that modern navigation systems (e.g., differential GPS) may offer more accurate positioning than what was used to position some of the surveys from which the electronic navigational chart was derived.

ENC vector format

ECDIS is compatible with S57 Ed.3 ENC format charts. ENC charts are converted to SENC for use with ECDIS.

The details for the chart are displayed in the electronic chart area and these can be modified. You can change the chart scale with the ZOOM IN and ZOOM OUT functions, and the scale range is 1:1,000 - 1:70,000,000.

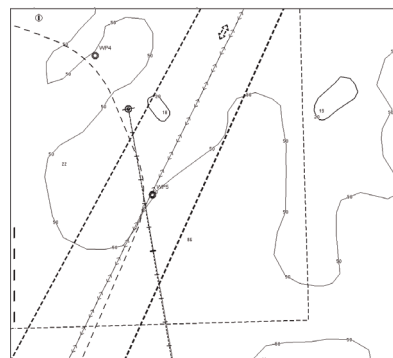

C-MAP vector format

The C-MAP charts require a contract with applicable provider. There are two types of C-MAP charts; C-MAP ENC SERVICE, which are officially recognized charts, and C-MAP PROFESSIONAL+, which are charts from a private source and cannot be used as a substitute for paper charts under any condition. To emphasize this point these charts are called "Non-ENC" charts in this manual.

Note: Some eToken dongles from the FEA-2xx7 can be used with this system. These are labeled "JeT FURUNO XXXXX". Contact your dealer for details.

This ECDIS accepts the following C-MAP chart types: ENC SERVICE, PROFESSIONAL+, ENC+ SERVICE and ADMIRALTY ENC SERVICE.

C-MAP ENC SERVICE charts comply with the IHO's (International Hydrographic Organization's) S-57 Edition 3 product specification. When used in the chart radar, the ENC data improves the safety of navigation at sea. When used in an ECDIS, the ENC data improves the safety of navigation at sea.

What is ENC delivery?

ENCs can be distributed as ENC delivery or SENC delivery. Both deliveries can be used in this system.

In ENC delivery, charts are distributed directly from source like PRIMAR, IC-ENC, JHA, etc. They are delivered onboard in ENC format (using S-57 and S-63) then the charts are installed into the system.

In SENC delivery, charts are already converted SENC before delivery and then installed into the system. A C-MAP ENC delivery is SENC delivery.

Important notices on ENC delivery

- If you are using both services (ENC and SENC deliveries) having the same chart name installed into the system through both deliveries, priority of displaying the chart is in ENC delivery.
- Chart updates for ENC delivery are only for charts of ENC delivery and chart updates for SENC delivery is only for charts of SENC delivery. You have to keep charts up-to-date separately.
- If you change from ENC delivery to SENC delivery, remove old charts from the system before installing charts from new delivery.

2. OPERATIONAL OVERVIEW

ARCS raster format

ARCS data is converted to SRNC format for use with the ECDIS. ARCS charts are digital reproductions of British Admiralty (BA) paper charts. They retain the same standards of accuracy, reliability and clarity as paper charts.

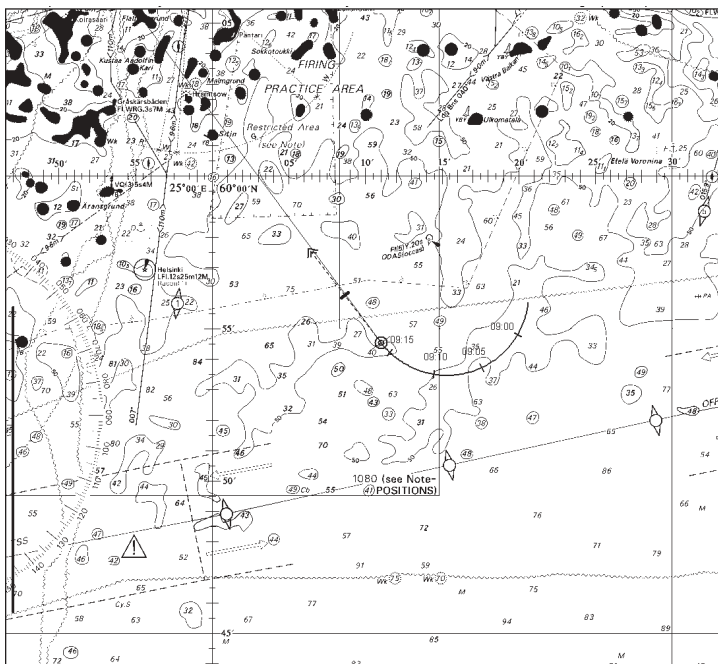

Zooming into the ARCS chart can be useful for magnifying a complex detail, however this decreases the density of the data displayed, and can give a false impression of the distance from danger.



2.1.2 Status bar

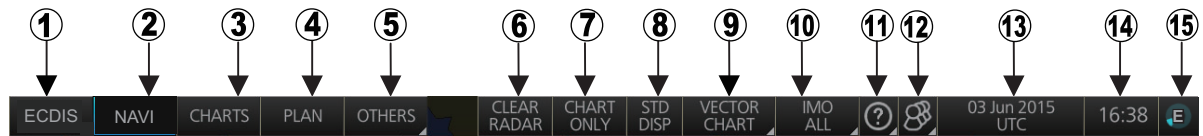

The Status bar mainly provides for selection of operating mode, chart type and IMO chart display setting.



No.	Button	Description
1	Display mode	No use
2	NAVI	Selects the Voyage navigation mode.
3	CHARTS	Goes to the Chart maintenance mode.
4	PLAN	Selects the Voyage planning mode.
5	OTHERS	<ul style="list-style-type: none"> • Sets system in SILENT mode (standby). • Plays back log data.
6	CLEAR RADAR	Hide the TT, AIS and radar displays. Shown only when one of the following conditions is met: <ul style="list-style-type: none"> • TT targets are shown on the display. • AIS targets are shown on the display. • Radar overlay is active.
7	CHART ONLY	Shows only the chart, when the left button is pressed and held down.
8	STD DISP	Restores the IMO standard display instantly.
9	Chart priority	Selects chart priority when both vector or raster are available.
10	Chart database	Selects the pre-defined presentations of ENC content: [IMO BASE], [IMO STD] or [IMO ALL]. [CUSTOM] appears when the symbols selected or deselected on the [Chart Display] menu do not match the preset conditions for [IMO BASE], [IMO STD] or [IMO ALL].
11		Displays the operator's manual, ECDIS program no. and system info.
12		Manages user profiles; opens the [Settings] menu.
13	Date	<ul style="list-style-type: none"> • Displays the date. • Selects the time to use, local or UTC. • Sets the time difference between local and UTC (to use local time).
14	Time	Shows the time, UTC or local.
15	 Working indicator	Rotates clockwise if the system is working properly. If it is not rotating the system is not working. Shortly after it stops spinning the buzzer sounds. Reset the power to restore normal operation.

How to operate the buttons on the Status bar

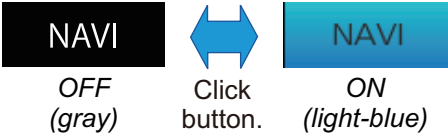
There are two types of buttons on the Status bar: Toggle button and Drop-down list button. Click the button to operate it.

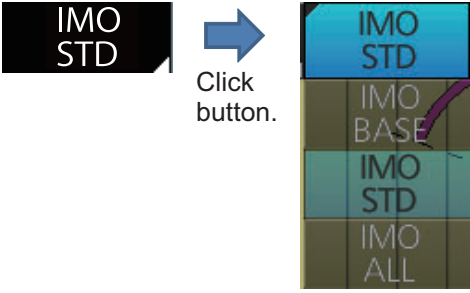



Button type	Operating procedure
<p>Toggle button</p> <p>A toggle button alternately selects one of two functions assigned to a button. The background color of a toggle button is light-blue when the button's function is enabled; gray (default color) when disabled. The [NAVI] button is an example of a toggle button.</p>	
<p>Drop-down list button</p> <p>A drop-down list button provides a drop-down list from which to select an option related to the label on the button. The [Chart Database] button is an example of a drop-down list button. See the right figure. A drop-down list button has a list status indicator whose position changes according to list status.</p> 	



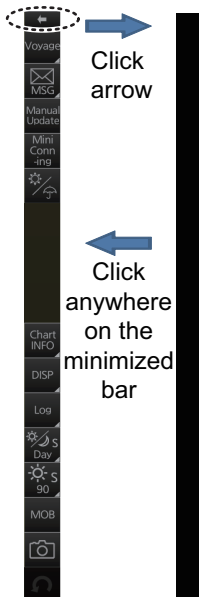

2.1.3 InstantAccess bar™

The InstantAccess bar™ runs vertically along the left edge of the screen. The bar contains all the operating functions related to the selected ECDIS operating mode (Voyage planning, Voyage navigation and Chart maintenance). The bar is divided into two sections, upper and lower. The buttons in the upper section change according to the ECDIS operating mode. The buttons in the lower section are common to all modes. A button with a triangle mark at its bottom right corner indicates a button with multiple functions.



2. OPERATIONAL OVERVIEW

Button	Description
Voyage navigation mode bar	
←	Minimizes the InstantAccess bar™. To restore the maximized bar, click anywhere on the minimized bar. 
Voyage	Route selects/deselects routes, and moves route to Voyage planning mode (for editing). Instant Track creates a temporary track to return to or make a temporary detour from the monitored course. User Chart selects/deselects user chart for monitoring. Monitor INFO shows the [Monitor Information] dialog box. Stop Monitoring stops monitoring of route, user chart.
	Processes AIS Safety and Navtex messages. If you have unread Navtex or Safety messages, the icon changes as shown right; “S” for unread Safety, “N” for unread Navtex, “S/N” for unread Safety and Navtex. 
Manual Update	Shows the menu for manual update of chart objects.
Mini Conning	Show or hides the mini conning display.
	Activates or deactivates the weather overlay.
Chart maintenance mode bar	
←	Minimizes the InstantAccess bar™.
Gate-1	Automatically installs selected charts and their licenses. Requires presetting at installation. Does not appear unless the presetting is done.
AUTO Import	Automatically loads and installs ENC charts.
Manage Charts	Deletes charts; installs charts manually.
Cell Status	Finds cell status.
License	Enters license information.
Public Key	Shows the current public key. The public key changes each time a new one is installed.
System	Functions for chart synchronization and chart data management. Sync Config selects the ECDIS units to synchronize. Sync Status checks synchronization status. Gate-1 Config. manages Gate-1 charts. Does not appear unless the presetting mentioned at [Gate-1] above is done. Reconvert reconverts SENC charts. Clear Charts removes chart data.
Voyage planning mode bar	
←	Minimizes the InstantAccess bar™.

Button	Description
Planning	Creates routes and user charts.
Report	Displays route and user chart reports.
Guide Box	Shows or hides the guide box, which provides range and bearing measurement between waypoints when creating a route.
Manage Data	Manages routes and user charts. Route imports, exports, deletes routes. User Chart deletes user charts. Data Import imports routes and user charts.
Common bar	
Chart INFO	Provides chart information. Chart Legend shows chart legend, in the Voyage planning and Voyage navigation modes. Viewing Dates sets Display date and Approved until dates. Chart 1 displays an overview of the ECDIS chart symbols.
DISP	SET shows the [Basic Setting] dialog box, [Chart Display] menu, [Symbol Display] menu, [Chart Alert] dialog box. TWO DISP splits the screen in two, vertically or horizontally, in the Voyage navigation mode. NtoM shows, hides the NtoM overlay. Keyboard shows, hides the software keyboard.
Log	Displays Chart log (ENC, ARCS, C-MAP), Event log (user event, POSN event)*, NAV log (Voyage, Details, Chart Usage), Target log (Danger Target). *Voyage navigation and Voyage planning modes
	Selects a color palette, day, dusk or night. The S or L at the right side of the label indicates how the color palette selection is shared, among the units of the system (S) or locally (L). The default setting is "S". See section 22.7 for details.
	Adjusts the brilliance of the monitor. The sub-setting [Control Unit's Backlight] is not used on the FMD-3100. The S or L at the right side of the label indicates how the brilliance selection is shared, among the units of the system (S) or locally (L). The default setting is "S". See section 22.7 for details.
MOB	Inscribes the MOB (ManOverBoard) mark.
	Takes a screenshot.
	Restores the previous condition in route and user chart creation.

How to operate the buttons on the InstantAccess bar™

The InstantAccess bar™ has four types of buttons: toggle button, drop-down list button, slider bar button, and specialty button. (The [MOB], Capture and Undo buttons are specialty buttons that provide a single-action function.)

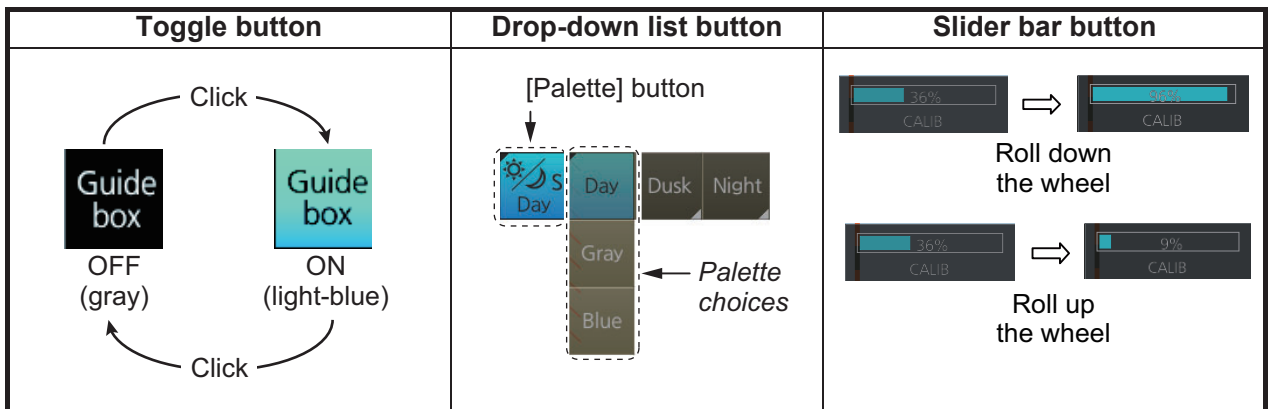

2.1.4 Sensor information box

The sensor information box displays ship's heading, speed, course over the ground, speed over the ground and position. When the user-selected sensor fails, the system automatically selects another sensor. For details, see "Color of nav data indications and sensor name" below.

The digital indications and sensor names are colored according to sensor state. See the table below.

- **HDG:** Heading and its source.
- **SPD:** Longitudinal speed and its source. The direction of transverse speed is indicated with arrows, ►, Starboard, ◄, Port.
- **COG:** Course over ground and its source.
- **SOG:** Speed over ground and its source.
- **POSN:** Latitude and longitude position of own ship and its source.

Note: The position source shall meet the requirements of IMO MSC.112(73).

HDG	213.1°	GYRO1
SPD	18.0 kn ◄ 7.2kn	GPS1 BT
COG	213.0°	GPS1
SOG	18.5kn	
POSN DGPS1	35° 44.507' N 139° 43.779' E	

Color of nav data indications and sensor name

The color of the nav data indications and sensor name change according to the state of the sensor data. The table shown below provides basic information. For detailed information, see Appendix 4. When no sensor data is received, the sensor source indication is blank. These indication methods comply with IEC62288 Ed.2.

Nav data indication	Color of nav data indication	Color of sensor name	State
	Green	White	Sensor is normal.
	Yellow	White	Validity of data is low or offset is applied.
	Yellow-orange	Yellow-orange	Data is invalid.
	Green, data shown with asterisks (**.*)	No display	Data is not being received.
	Yellow	White	Data is input manually (dead reckoning).

Note: Depending on the installation settings for integrity checks, the color of the navigational data may change. [Passed]/[Low accuracy]: Green, [Doubtful]: Yellow, [Failed]/[Excluded]/[Not Available]: Yellow-orange.

2.1.5 Own ship functions box

The own ship functions box shows information about own ship, enables offset, and does TM reset.

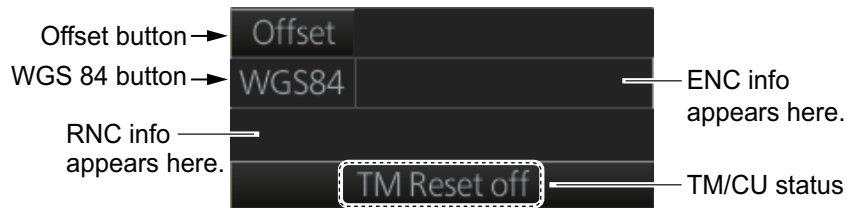

- **[Offset]** button: See section 18.8.1. This button is only operative in the Voyage navigation mode.
- **[WGS84]** button: Convert position data between datum; go to selected position on the current chart. Click the button to display the dialog box shown below. To convert a position from one datum to another, select the datum source at the [Source] pull-down list and enter position. Select the datum to convert to at the [Converted] pull-down list then click the  button. The position on the chart selected is shown below the [Converted] pull-down list. To go to a position, click a [Go To] button.

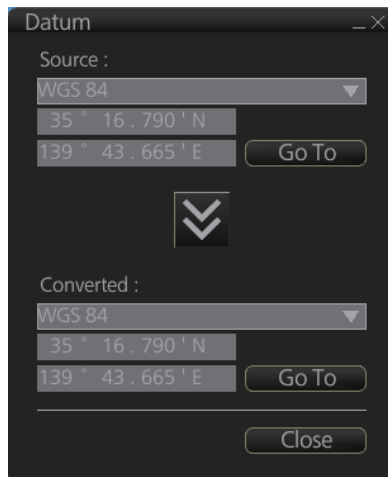

- **ENC info:** ENC chart info appears here.
No indication: ENC chart is currently displayed.
"ENC data available": Currently, RNC chart is shown, but ENC chart is available.
"Non-ENC data": Non-official ENC material, in yellow characters. See section 3.20.
- **RNC info:** "RNC data" appears (in yellow) when raster chart is in use.
- **TM/CU status:**
"TM/CU Reset": True motion reset is active. (Chart is stationary and own ship moves on the chart.)
"TM Reset off": When dragging the chart; true motion is OFF.
"Ship off screen": Ship is out of the display area. To restart true motion, click the indication.

2.1.6 Route information box

Asterisks appear in data locations when no route is selected for navigation.

- **Route:** Name of monitored route
- **Plan Speed:** Planned speed to approach "To WPT".
- **Plan Course:** Planned course between previous WPT and "To WPT".
- **Course to Steer:** Calculated set course to follow the monitored route, including XTD, drift and gyro error compensations.
- **XTD Limit:** Cross track distance, set when planning a route. Shown in white when the vessel is within the designated "off-track" limit. Shown in red when the vessel exceeds this threshold.
- **XTD:** Perpendicular distance the ship is from the intended track. The XTD figure can be shown in meters or nautical miles. To change the unit, right-click the Route Information box to show the context menu. Click XTD then select the desired unit. You can also change the unit from the [unit of "XTD"] item in the [Route Information] menu.
- **To WPT:** The waypoint that the ship is approaching.
- **DIST to WOP (Wheel Over Point):** Distance to the point where rudder order for course change at "To WPT" is given.
- **Time to Go:** Time to go to WOP (hh:mm:ss).
- **Turn RAD:** Planned turning radius at "To WPT".
- **Turn Rate:** Calculated rate of turn that is based on current speed and planned turning radius.
- **Next WPT:** The WPT following the "To WPT".
- **Next Course:** Next course (in degrees).

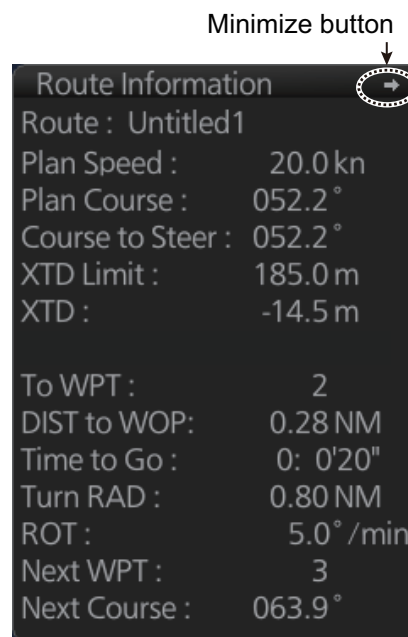

Course to steer

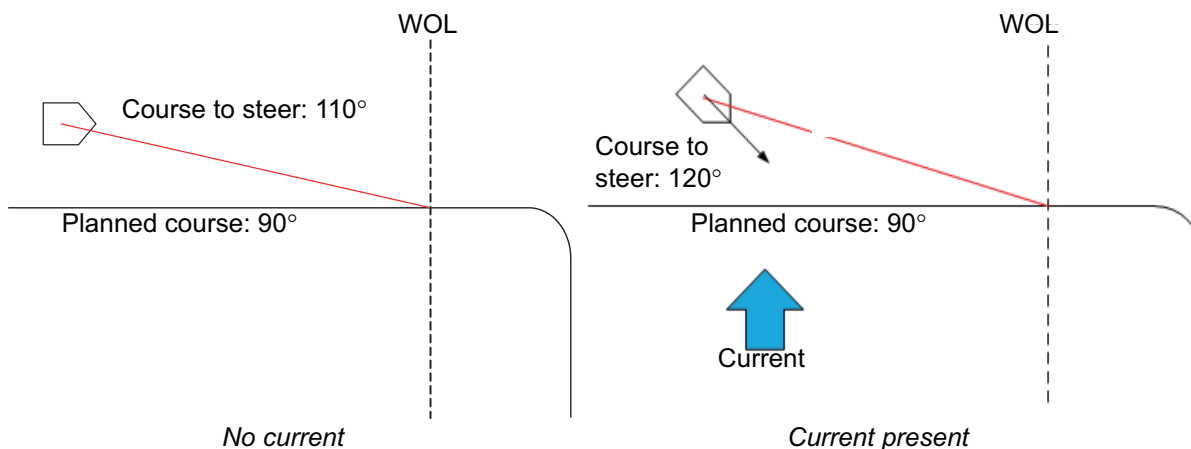

2.1.7 Overlay/NAV Tools box

The Overlay/NAV Tools box sets up the following:

- TT/AIS
 - Echo (radar overlay)
 - Parallel index lines
 - Range rings
 - Predictor (predicts ship's future movements)
 - Under the keel clearance graphic
 - Anchor watch
 - Look-ahead
 - Curved EBL*
- *: Available only when a EC-3000 with TCS functionality is connected to the same network.

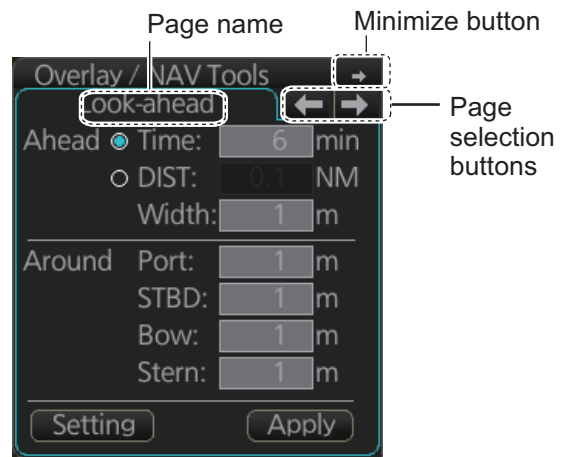

See chapter 13 and 14 for TT/AIS descriptions. Refer to section 16.2 for the radar overlay.

2.1.8 Alert box

The [Alert] box shows operational and system alert messages, with alert ID no. and alert message. See chapter 20.



2.1.9 Permanent warning box

The permanent warning box displays chart-related warning messages. The box cannot be closed or minimized.

Click the arrow to show details. Click the arrow again to minimize the box.

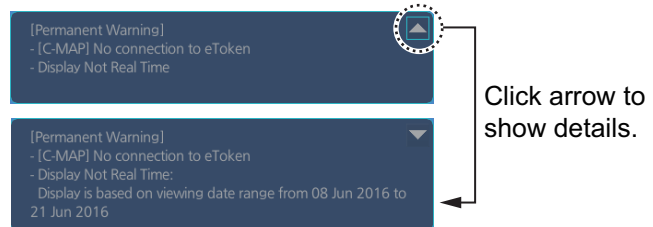

2.1.10 EBL, VRM boxes

The EBL measures the bearing to an object, and the VRM measures the range to an object. See section 2.8.

2.1.11 North mark

The north mark appears at the top left of the Chart for Radar display, is always visible, and points in the northerly direction. At high latitudes where north is not in a set direction, the north mark appears with the text "at own ship" or "at center" below the mark to show the reference point.



North mark

- "at own ship": Shown when your vessel is displayed on-screen. North is shown with your vessel as the reference point.
- "at center": Shown when your vessel is not displayed on-screen. North is shown with the center of the screen as the reference point.

2. OPERATIONAL OVERVIEW

2.1.12 Context-sensitive menus

Context-sensitive menus are available at the locations shown below. Right-click the applicable area then select the appropriate item from the menu. The availability of the context-sensitive menu depends on the mode in use, as shown in the table below.

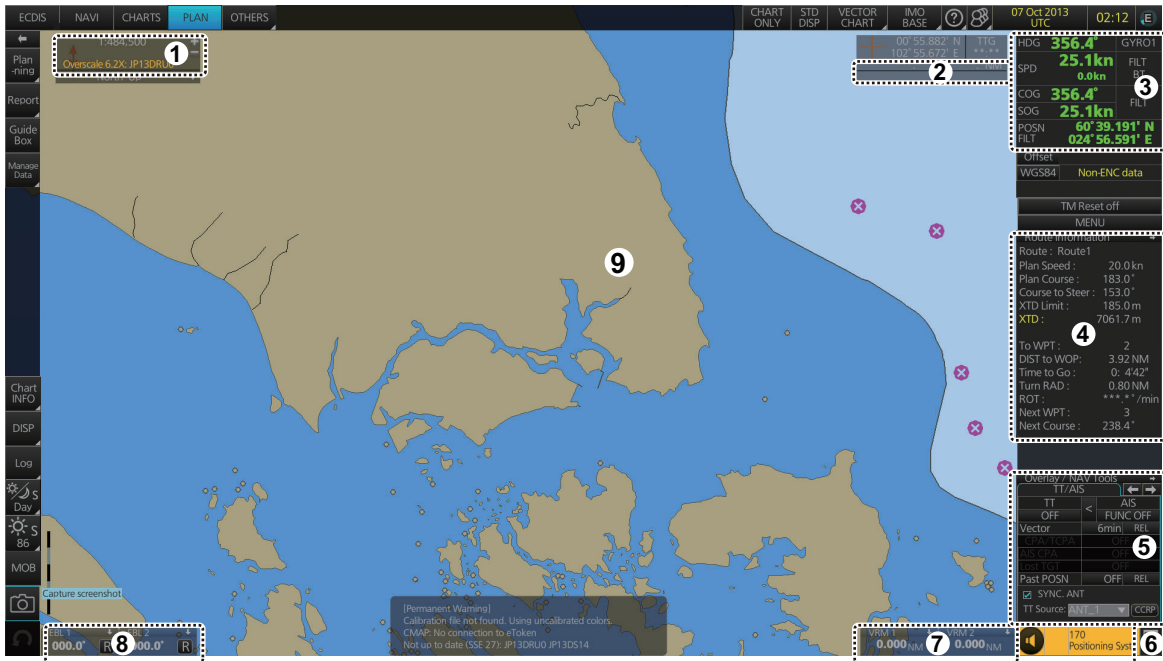

No.	Item	Functions	Mode and availability		
			NAVI	CHART	PLAN
1	Chart scale	Drop-down list of chart scales.	Yes	Yes	Yes
2	Cursor info display	Switch cursor displays.	Yes	Yes	Yes
3	Sensor selection	Select sensors.	Yes	Yes	Yes
4	Route selection, route information	Select /unselect route for monitoring*; Move to plan*; Select user chart for monitoring*; Monitor INFO box*; Stop route monitoring; XTD.	Yes	Yes (XTD on-ly)	Yes (XTD on-ly)
5	TT, AIS page	Access TT, AIS functions.	Yes	Yes	Yes
6	Alert list, Alert log	Open alert list, alert log.	Yes	Yes	Yes
7	VRM reference	Select VRM reference; offset (heading or north).	Yes	Yes	Yes
8	EBL reference	Select EBL reference; offset (heading or north).	Yes	Yes	Yes
9	Electronic chart area	Own ship mark (or cursor position) to screen center; object info; chart legend; manual update*; divider, hide MOB, weather info**.	Yes	No	Yes

*NAVI mode only. **Available when weather overlay is active.

2.1.13 How to enter alphanumeric data

On some screens it is necessary to enter alphanumeric data. The data can be input two ways: software keyboard, trackball, or optional keyboard.

Alphanumeric data entry from the optional keyboard

- 1. Click the input box.

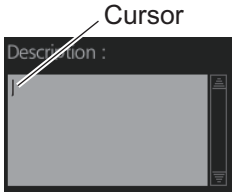

Input box example

- 2. Press appropriate keys on the keyboard and press the **ENTER** key.

Key	Function
Tab	Move the selection cursor.
Caps Lock	Switch between upper case and lower case alphabet.
Shift	Turn caps lock on and off with the Caps Lock key.
BS	Erase the character left of the cursor.
Enter	Terminate keyboard input; insert line feed.
↑, ↓, ←, →	Move cursor in direction of arrow.
Spacebar	Insert a space
Ctrl	No use.

Alphanumeric data entry from the software keyboard

A software keyboard is also available for entry of alphanumeric data. Do as follows to use the software keyboard. Display the keyboard before opening menus.

- 1. On the InstantAccess bar™, press the [DISP], [] and [ON] buttons to show the software keyboard. The [BS], [Enter], [↑], [↓],[←], [→] and [Spacebar] on the keyboard function the same as those keys on any ordinary keyboard.



Space bar

- 2. To switch between the alphabet keyboard and symbols keyboard, click the [!\$&] key.

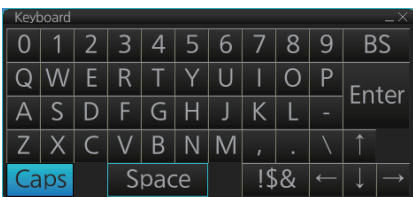

Alphabet keyboard

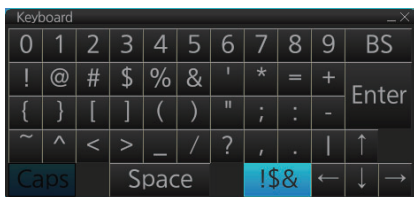

Symbols keyboard

2. OPERATIONAL OVERVIEW

3. Click the input box.
4. Click appropriate keys and finally click the [Enter] key.

To erase the software keyboard, click the X button at the top right corner of the keyboard.



Alphanumeric data entry with the trackball module

The trackball module can also be used to enter alphanumeric data.

1. Put the cursor in the input box. Up and down arrows appear at the right side of the box.
- 
2. Enter data by one of the methods shown below.
 - Spin the scrollwheel to set data. Upward to decrease the value; downward to increase the value.
Note: The incrementing direction can be changed with [Wheel rotation] in the [Customize] menu of the [Settings] menu.
 - Click ▲ to increase the value; ▼ to decrease the value.

How to enter latitude and longitude data with the trackball module

The trackball module can also be used to enter latitude and longitude data.

1. Put the cursor in the input box. A selection cursor (light-blue) appears.
- 
2. Enter data by spinning the scrollwheel.
 3. To switch coordinate between N and S and vice versa, put the cursor at the right edge of the input box. Dual arrows appear
- 
4. Click to switch the coordinates. The method to switch E to W and vice versa is the same.

2.2 How to Select the ECDIS Operating Mode

The ECDIS has three operating modes: Voyage navigation, Chart maintenance, and Voyage planning. Select the mode from the Status bar with the [PLAN], [CHARTS] and [NAVI] buttons. The background of the button of the active mode is blue.

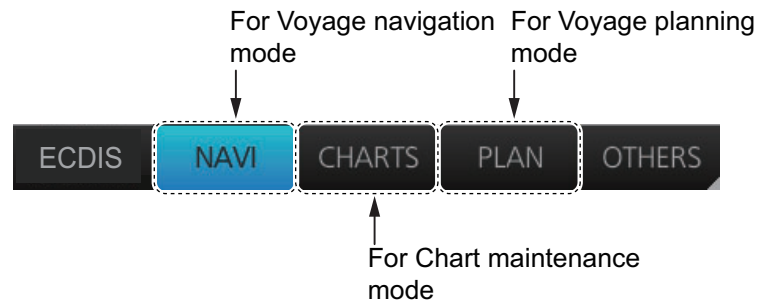

Note 1: When switching between the Voyage navigation and Chart maintenance modes it may take several minutes to read the chart database when using C-MAP charts or there are many charts installed.

Note 2: If the equipment accepts no key operation after switching to the Chart maintenance mode, reset the power.

2.3 How to Select the Chart Scale

When you open a chart it is displayed with the default scale, called the compilation scale. To change the chart scale, do one of the procedures shown below. The scale range is 1:1,000 to 1:70,000,000.

- Click the chart scale selection buttons in the Chart scale/presentation mode box.
- Right-click anywhere inside the Chart scale/presentation mode to show a drop-down list of chart scales.
- Put the cursor anywhere on the chart and spin the scrollwheel.

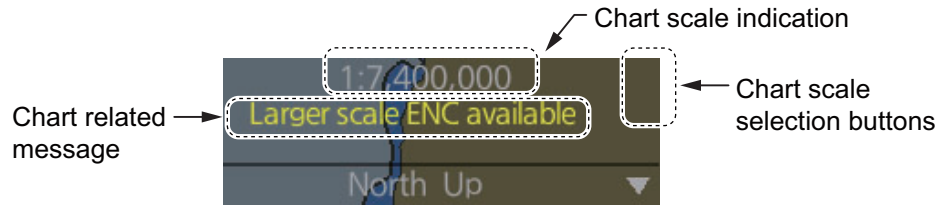

Note: When the radar overlay is active the chart scale is shown in nautical miles (NM).

The table below lists the chart related messages and their meanings.

Message	Meaning	Remarks
Display Not Real Time*	Displayed date is not the current date.	
Non-ENC data	ENC non-compatible chart in use.	
Larger scale ENC available	Larger scale available at current position (TM reset ON) or cursor location (TM reset OFF).	
Overscale	Scale too large.	
RNC data	RNC chart in use.	ARCS only
Larger RNC available	Larger RNC is available.	ARCS only
Underscale	Scale too small.	ARCS only
ENC data available	ENC data available for current area.	ARCS only
WGS shift undefined	WGS shift is not defined.	ARCS only
RM(OFF)	Relative motion off.	

*: Shown as "Display Not Real Time: display is based on viewing date range from (start of date range) to (end of date range)" when the permanent warning dialog is maximized.

2.4 How to Select the Presentation Mode

There are seven presentation modes available. However, depending on whether voyage navigation mode or voyage planning mode is active, some presentations modes are not available.

Presentation Mode	Voyage navigation mode	Voyage planning mode
North-up TM	Available	Available*2
North-up RM	Available	Not available
Course-up TM	Available	Available*2
Course-up RM	Available	Not available
Route-up TM*1	Not available	Available*2
Route-up RM*1	Available	Not available
Head-up RM	Available	Not available

*1: Available only when a route is being monitored.

*2: "TM" not shown in the presentation mode indication.

There are two methods to select a presentation mode:

- Click the presentation mode indication to cycle through the presentation modes.
- Click the ▼ indication to show a drop-down list of presentation modes, then click the mode you want to use.

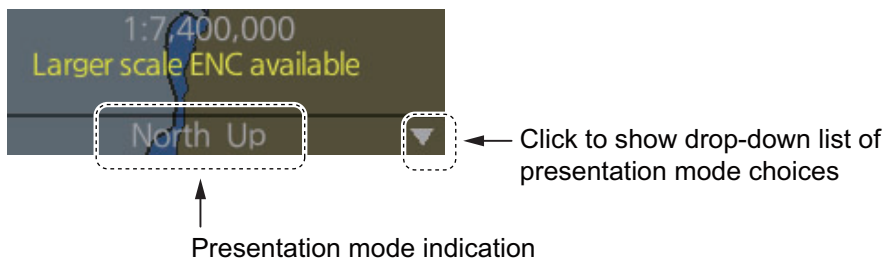

Description of presentation modes

- North-up : North (0°) is the top-center of the screen.
- Course-up : Course is the top-center of the screen (at the time of selection).
- Route-up : The planned course for a route being monitored is the top-center of the screen. If route monitoring is disabled, Route-up mode automatically changes to Course-up mode.
- Head-up : Current heading is the top-center of the screen.
- TM : True Motion. Own ship mark moves in relation to actual vessel movement, chart is displayed in a fixed orientation.
- RM : Relative Motion. Own ship mark is fixed at center of screen, chart moves in relation to vessel movement.

2.5 Cursor Position Box

The Cursor position box shows

- Cursor position in latitude and longitude
- Time to go to the cursor position
- The bearing (True or Relative) and range to the cursor position, or x-y coordinates of cursor position. Click the bearing and range or x-y coordinates indication to switch the display, in the sequence shown below.

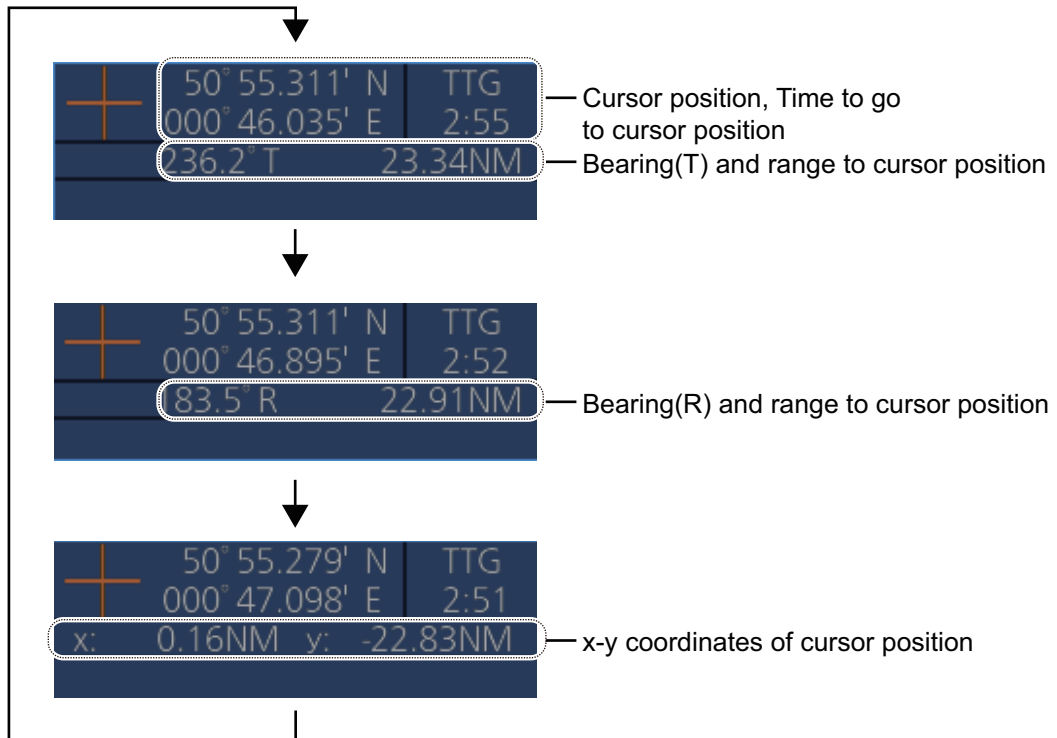

2.6 True Motion Reset

In the true motion mode, the chart is stationary and own ship moves on the screen. With TM reset active, own ship moves until it reaches the true motion reset border-line(s), then the chart is redrawn and own ship jumps back to an opposite position on screen based on its course. (This resetting can also be done manually by clicking the [TM/CU Reset] button.) When the TM reset function is active, "TM/CU Reset" appears at the right side of the display.

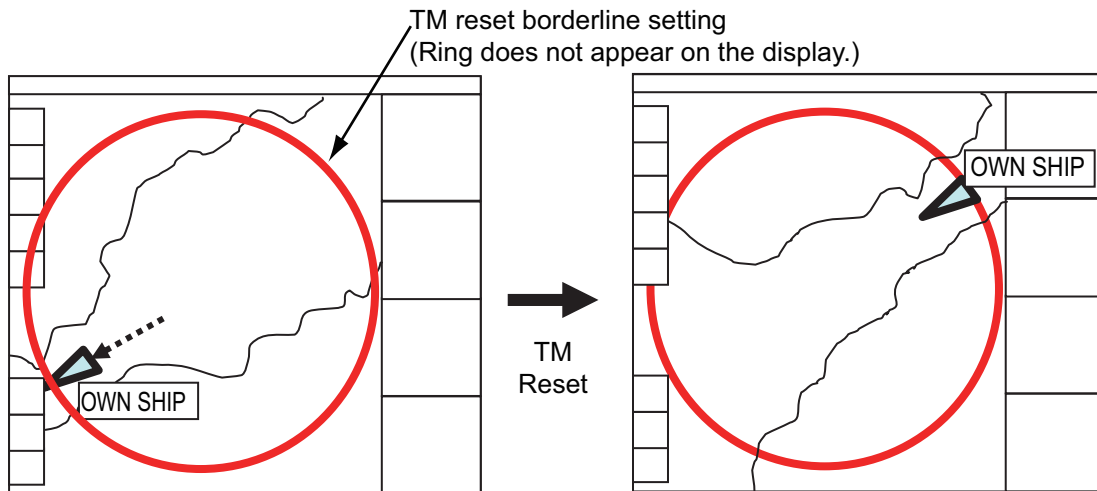

How to enable, disable automatic TM reset

To enable automatic TM reset, click the [TM Reset off] indication at the right side of the display to show [TM/CU Reset].



When the TM reset is disabled, change the chart scale with the scrollwheel and scroll the chart by drag and drop. The own ship information box shows [TM Reset off]. When own ship moves off the screen the box shows [Ship off screen].

How to set the true motion reset borderline

You can set the limit for TM reset (in percentage) on the [Basic Setting] page. See section 4.2.2.

2.7 How to Control Route and User Charts in Voyage Navigation and Voyage Planning Modes

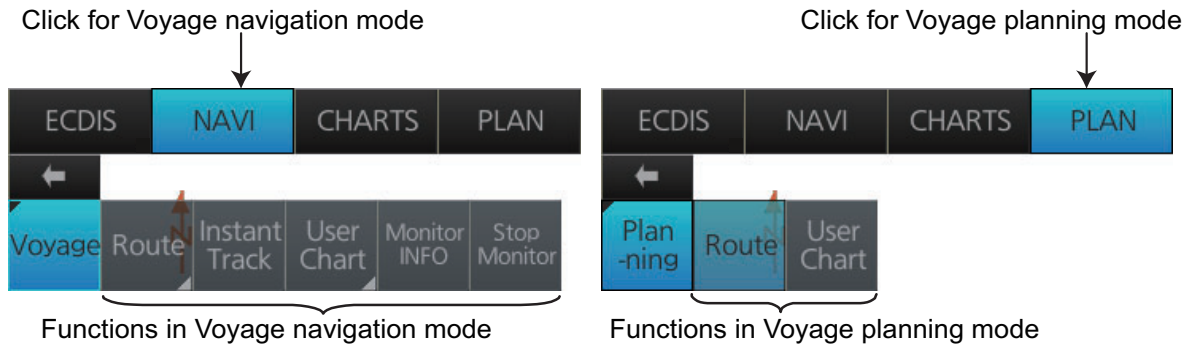

Click the appropriate chart mode button [PLAN] or [NAVI] at the top of the display to go to respective mode. For the Voyage navigation mode, click the [Voyage] button then click the button corresponding to the action to take. For the Voyage planning mode, click the [Planning] button followed by the [Route] button to select a route, or [User Chart] button to select a user chart.

Voyage navigation mode functions
<p>[Route]: This button has three functions:</p> <ul style="list-style-type: none"> • [Select]: Selects the route to monitor. • [Unselect]: Deselects monitored route. • [Move to Plan]: Moves monitored route to Voyage planning mode (for editing).
<p>[Instant Track]: Opens the [Instant Track] dialog box to create a temporary track to return to or make a temporary detour from the monitored course (see section 11.8).</p>
<p>[User Chart]: This button has one function.</p> <ul style="list-style-type: none"> • [Select/Unselect]: Selects and unselects user charts from monitoring regardless of route being monitored
<p>[Monitor INFO]: Opens the Monitor Information dialog box, to view monitored route, linked user chart and monitoring user chart information.</p>
<p>[Stop Monitor]: Stops monitoring a route and user charts.</p>
Voyage planning mode functions
<p>[Route]: Shows the [Route Plan] dialog box to create or edit a route.</p>
<p>[User Chart]: Shows the [User Chart] dialog box to create or edit a user chart.</p>

2.8 How to Use the VRM and EBL

The VRM measures the range to an object and the EBL measures the bearing to an object. There are two each of VRMs and EBLs. The lengths of the dashes on the EBL2 and VRM2 are longer than those of the EBL1 and VRM1 to distinguish them. The color of the VRMs and EBLs is orange.

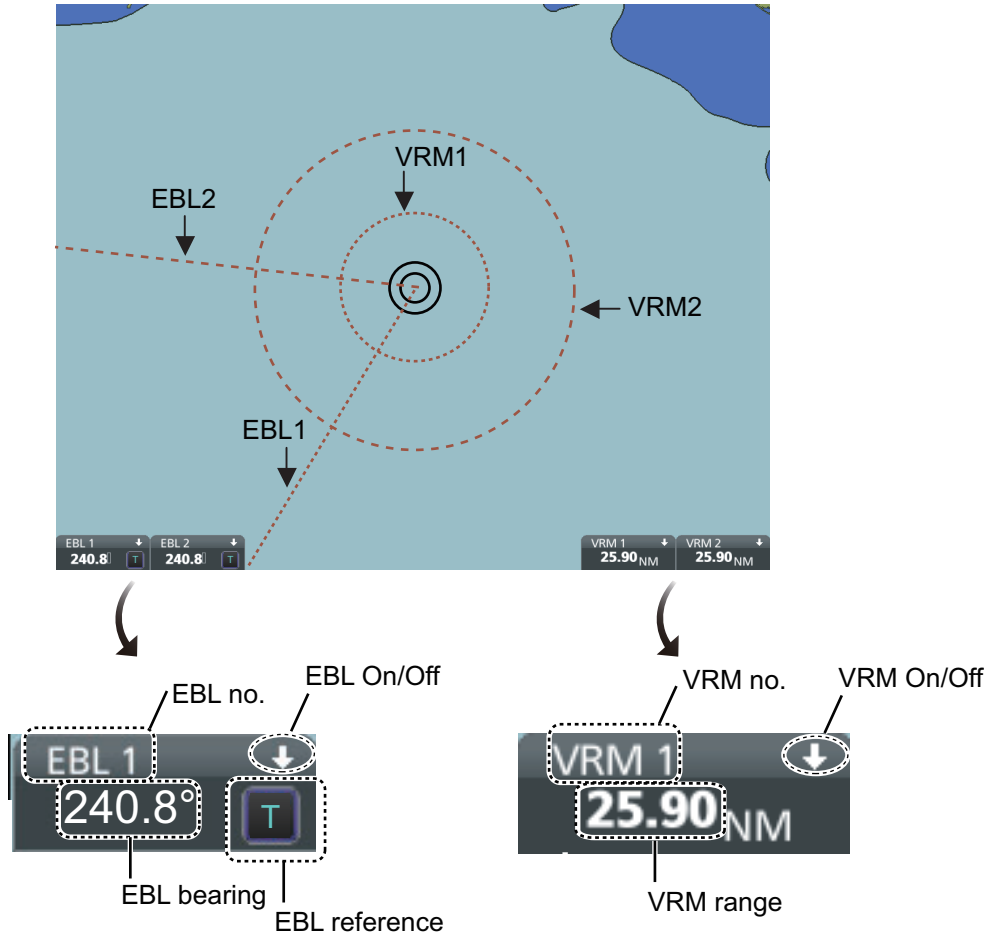

2.8.1 How to hide/show an EBL, VRM

Click the arrow on an EBL or VRM box to hide the respective marker. To redisplay the marker, click the minimized box.

2.8.2 How to measure the range and bearing

Range: Put the cursor on the VRM then drag the cursor until the VRM is on the inner edge of the object.

Bearing: Put the cursor on the EBL then drag the cursor until the EBL bisects the object.

2.8.3 How to select bearing reference

The EBL bearing reference can be true or relative. Click the EBL reference indication to display T (True) or R (Relative).

2.8.4 EBL, VRM functions available with the context-sensitive menu

The EBLs and VRMs have additional functions that are accessed from the context-sensitive menu. Right-click any VRM or EBL box to show the context-sensitive menu.

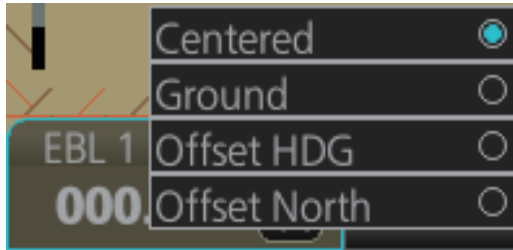

Function	Description
Centered	Centers the origin of the EBL and VRM on the current position.
Ground	Anchors the EBL and VRM to ground; neither the EBL or VRM move with ship's movement.
Offset HDG	<p data-bbox="555 1182 842 1240">Drag and drop EBL, VRM on desired location.</p> <p data-bbox="874 1070 954 1151">Select [Offset HDG].</p> <p data-bbox="906 1182 1326 1294">When vessel changes course, the EBL, VRM move so that the range (L) and angle (D) to their centers stays fixed.</p>
Offset North	<p data-bbox="555 1704 858 1762">Drag and drop EBL, VRM on desired location.</p> <p data-bbox="890 1570 970 1673">Select [Offset North].</p> <p data-bbox="895 1704 1331 1861">The EBL, VRM move to keep the angle from North to the center of the EBL, VRM, even if the vessel changes course. The distance to the center of the EBL, VRM is fixed.</p>

2.8.5 How to select range calculation method

The range calculation method for the EBL and VRM can be selected to Rhumbline or Great Circle. Do as follows to select a calculation method.

1. Open the menu, then select [NAV Tools] and [Geometry] to show the [Geometry] page.

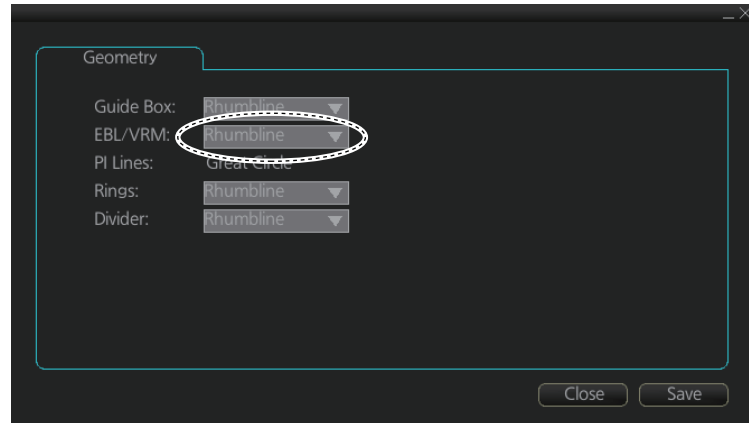

2. Select [Rhumbline] or [Great Circle] with the drop down list box for [EBL/VRM].
3. Click the [Save] button to save the setting, then click the close button to finish.

2.9 Datum

2.9.1 General

Datum is a mathematical model of the earth based on which a sea chart is produced. If the datum of a position sensor and that of a sea chart are different, a transformation has to be made somewhere in the system. Not doing so can result in errors of several sea miles. The difference between two datum is never constant, but depends on position. This means that the difference between WGS-84 and local datum, generally used in paper charts, is not generally valid with electronic sea charts.

2.9.2 Paper charts

Datum used in paper charts have been traditionally national datum for historical reasons. Many paper charts do not have a marked datum, therefore compatibility with electronic charts may be complicated. In some paper charts, the correction terms are printed in lieu of datum, for correction of the WGS-84 system satellite locations. The correction terms are usable but only with the paper chart in question.

2.9.3 Electronic sea charts

- The ENC vector material has to be produced by a National Hydrographic Office in the WGS-84 datum.
- The ARCS (raster) material includes polynomials for each chart, making it possible for the ECS system to solve the difference between the WGS-84 datum and the local datum with an accuracy sufficient for authority responsibility. In some charts, the mentioned difference is not known with sufficient accuracy, resulting in displaying a message in the Cursor position box when displayed in ARCS compatible systems.

2.9.4 Positioning devices and datum

In early days of electronic positioning devices, datum received little attention because the commonly used systems utilized special charts (like Decca charts). Later on, data output was added to these systems, but still no attention was paid to datum and the position errors were considered as an inaccuracy of the system. With the spread of the GPS, however, datum has become better known. An accurate position is of no value if co-ordinates are in a wrong datum. GPS satellites utilize the WGS-84 datum.

2.9.5 ECDIS and datum

The ECDIS uses ENC material, produced to standards using WGS-84 datum. Positioning devices connected to the ECDIS must work in the WGS-84 datum. IMO requires that the ECDIS must give an alert if the datum of a positioning device is not the WGS-84.

2.10 Set up Before Departure

2.10.1 Updates before departure

Update chart material

Update your chart material before embarking on a new voyage. See section 3.21.

Display and approve dates for charts and manual updates

Note: It is very important that you set the [Display Date] and [Update Review] dates for charts as the current date.

There may be features that require chart viewing dates or seasonal dates in charts. Accordingly, if you have not set Display and Update Review dates as the current date there is a possibility that you can get a wrong presentation or some feature may be absent. See section 5.2.

Create or update user chart. Notes

If necessary, create a new user chart and Notes or modify existing ones. See chapter 10.

Chart alert calculation

Set chart alert areas suitable for your coming voyage, on the [Look-ahead] page in the [Overlay/NAV Tools] box. See section 8.2.

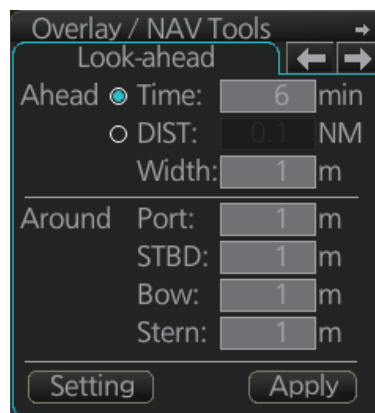

2.10.2 Create or update a route

Create a new route or modify an existing one. See chapter 9.

Check your route against chart alerts

Before you sail your route, you should always check your route against chart alerts. This is important because your S57 charts and manual updates may contain chart viewing dates information. You can check chart alerts from the [Check Results] page on the [Route Plan] dialog box.

The following information is stored with the monitoring route plan:

2. OPERATIONAL OVERVIEW

- Conditions for chart alerts during route monitoring, which includes safety contour and other chart alerts, on the [Alert Parameters] page of the [Route Plan] dialog box.



- Name of the user chart to be used during route monitoring together with this planned route, on the [User Chart] page of the [Route Plan] dialog box.

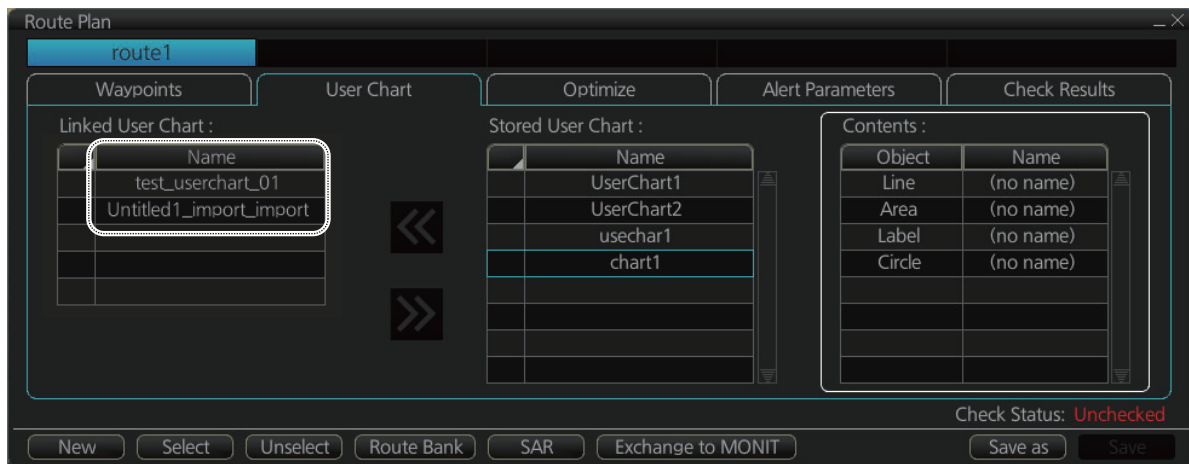

- Name of the Notes to be used during route monitoring together with this planned route, on the [User Chart] dialog box.

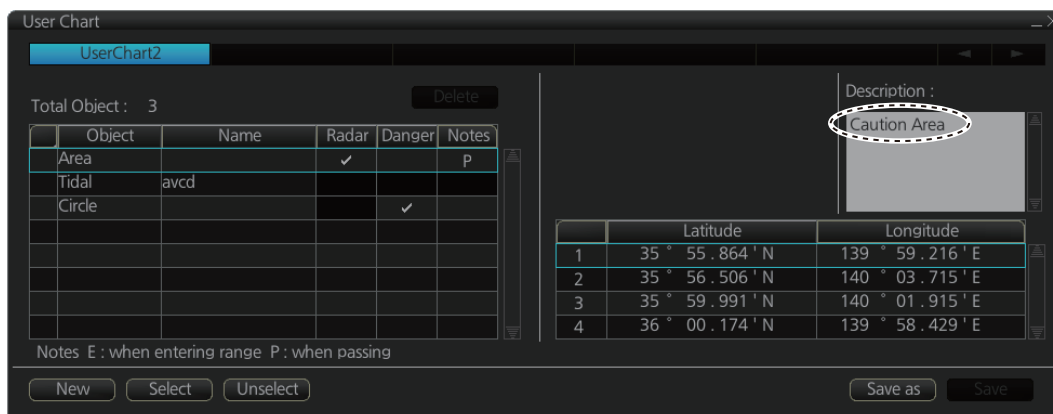

Recalculate timetable and ETA values

Timetable and ETA values can be recalculated from the [Optimize] page in the [Route Plan] dialog box. Minimally set ETD to equal departure time, and set optimization values.

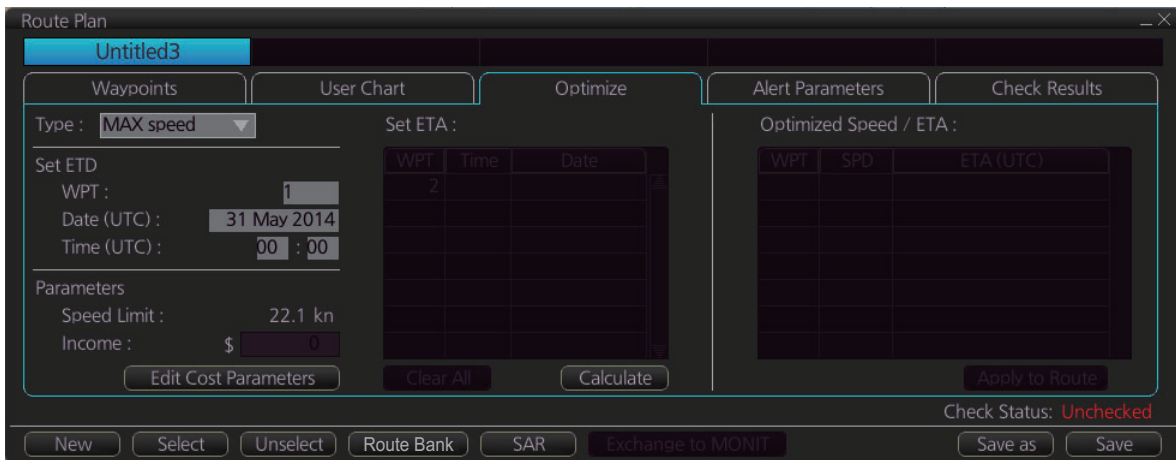

2.10.3 How to check and prepare route, user chart to monitor

Select the route to monitor, view linked user charts

Select a route for the voyage: In the Voyage navigation mode, click the [Voyage], [Route] and [Select] buttons, or right-click the route indication in the [Route Information] box (right edge of screen) then select [Select Route]. See chapter 11. The [Monitor Information] dialog box appears, showing the [Waypoints] tab.

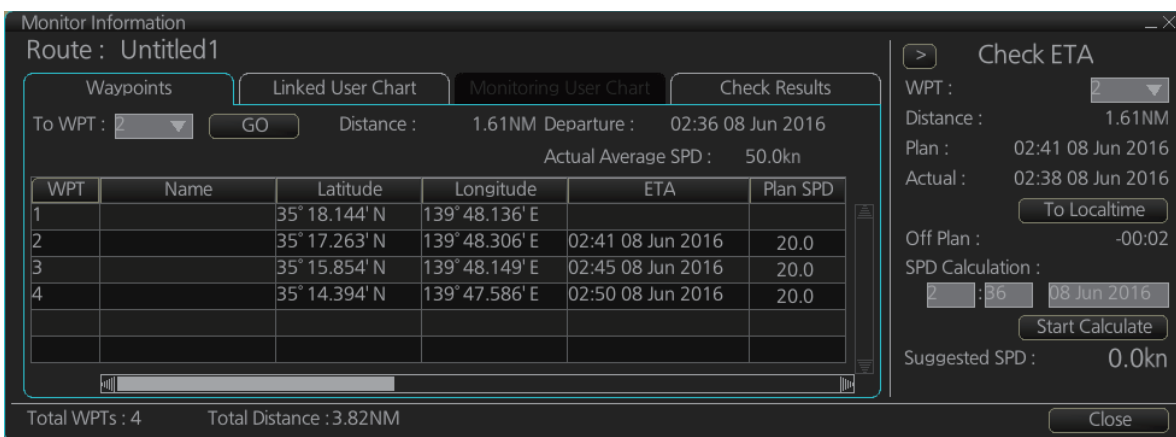

Note: A route cannot be opened if its planned settings are different from its navigation settings. The reason is given on the [Select Route] dialog box. In this case, open the route in the Voyage planning mode and click the [Check Route] button, on the [Alert Parameters] page. Adjust the route as necessary.

The To WPT can be selected, however WPT 01 cannot be selected.

2. OPERATIONAL OVERVIEW

To see all the user charts linked to the route, click the [Linked User Chart] tab to show the names of all the user charts linked to the route. Click a user chart to view its contents.

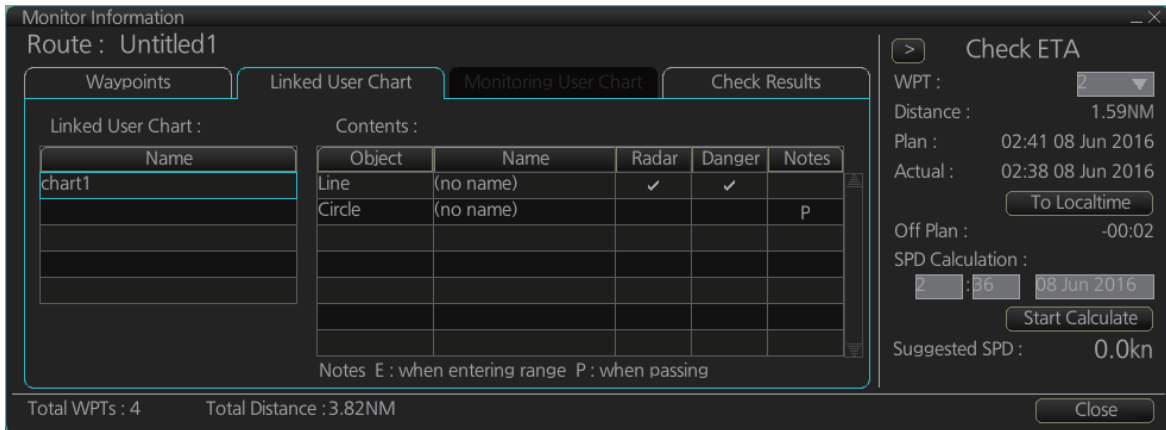

Select confirm conditions of the route plan

Check the setting on the [Chart Alert] dialog box; click the [DISP], [SET] and [Chart Alert] buttons to show that dialog box.



Select the user chart(s) to monitor

A user chart can be monitored without linking it to a route. You can select a user chart two ways.

- Click the [Voyage], [User Chart] and [Select/Unselect] buttons on the InstantAccess bar™ to open the [Select Monitor User Chart] dialog box.
- In the Voyage navigation mode, right click anywhere in the Route information box (right side of screen) to show the [Select Monitor User Chart] dialog box.

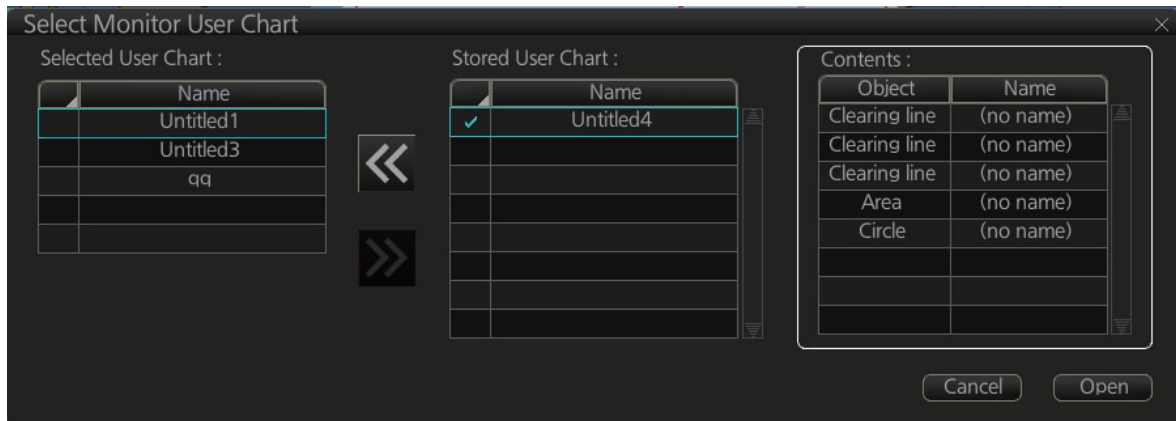

Check the chart(s) to use in the [Stored User Chart] window, then click the [<<] and [Open] buttons. The [Monitor Information] dialog box automatically appears and the user chart(s) selected are displayed in the [Monitoring User Chart] tab. Click a user chart to view its contents.

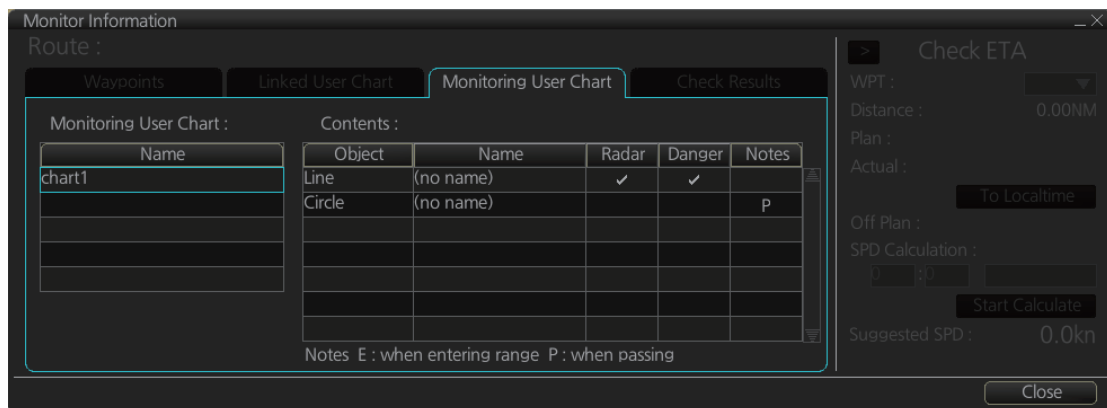

2.10.4 Check configuration of navigation sensors

You can check the configuration of your navigation sensors in the [System Sensor Settings] page and [Local System Settings] page in the [Sensor] menu.

Check speed settings ([SPD] page)

Open the menu and click the [SPD] tab in the [System Sensor Settings] page or [Local System Settings] page. The user can select navigation sensors for use in navigation and view their current values.

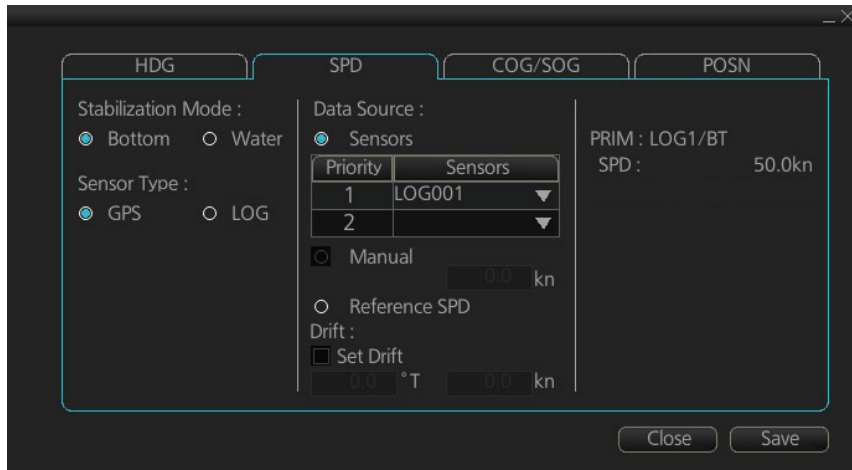

SPD page, local sensor

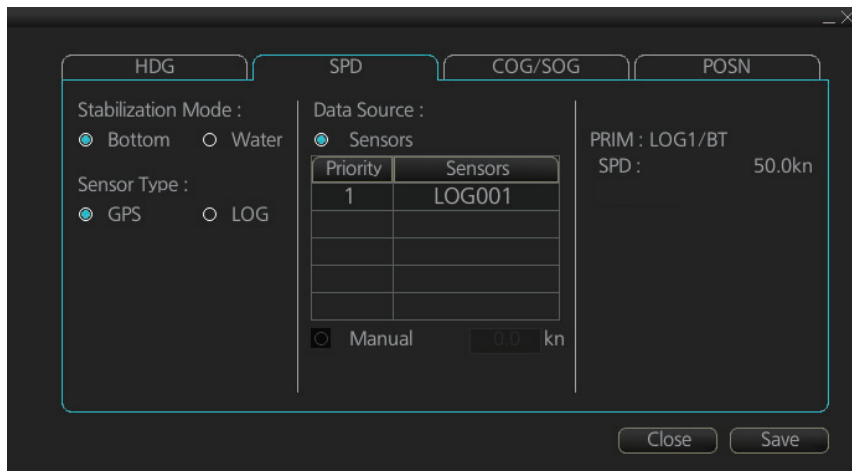

SPD page, system sensor

If there is no value shown for a sensor, this means that the sensor is not valid. Note that the content of these pages depends on the sensors that are in use on the ship.

The content of the display changes with sensor.

Note that manual speed should only be used in an emergency, when no other speed reference is available. Remember that position sensors are also available as speed sources.

Check position sensors (POSN page)

Open the menu and click the [POSN] tab in the [System Sensor Settings] page or [Local System Settings] page. The [PRIM] and [Second] labels indicate the type of the position sensor. (In the figure below the [PRIM] label shows FILT). [PRIM] and [Second] indicate sensor status and priority.

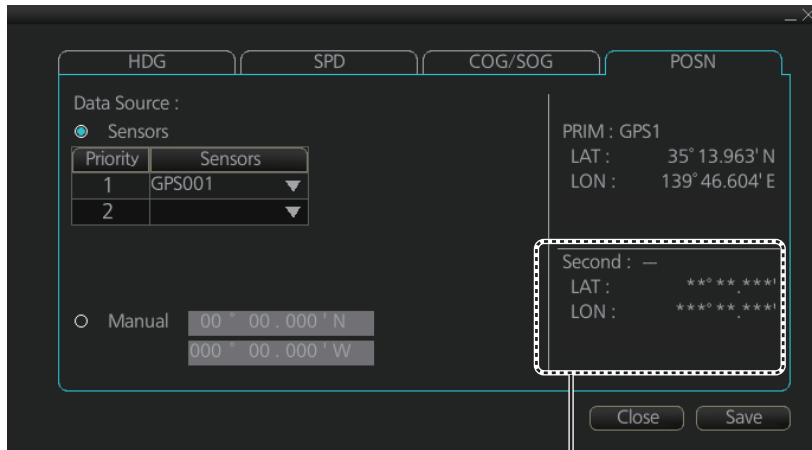

The indication for the second sensor appears even when only one position-fixing equipment is connected.

Only one sensor can be [PRIM] while the others are [Second] or off position. After a sensor is turned off, its status is changed to [Second] state. When a position sensor state is changed to [PRIM], the sensor formerly [PRIM] becomes [Second].

Select the [PRIM] navigation sensor as the sensor that is considered to be most accurate and reliable. Set all other navigation sensors as [Second].

2.10.5 How to reset odometer and trip meter

To reset the odometer and/or trip meter do as follows:

1. Open the menu and select the [Voyage] menu from the [NAVI Log] menu.

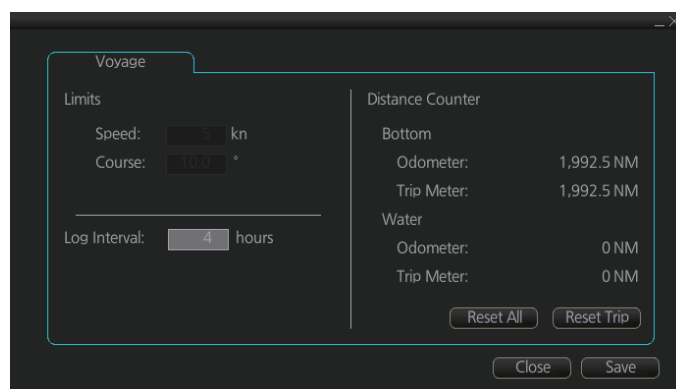

2. Click one of the following buttons as appropriate.
 - Reset Trip:** Reset the trip distance (ground and water).
 - Reset All:** Reset both the odometer and the trip meter (ground and water).
3. Click the [Close] button to finish.

2. OPERATIONAL OVERVIEW

This page is intentionally left blank.

3. HOW TO MANAGE CHARTS

This chapter mainly shows you how to install the public keys, licenses and charts, manually update chart objects, and synchronize charts. All chart-related operations begin from the Chart maintenance mode, which you access by clicking the [CHARTS] button on the Status bar.

Note 1: Charts, routes and user charts are shared with other FMD-3xx0, FCR-2xx9 and FAR-3x00 units, via LAN. Data is shared automatically; no operation is required.

Note 2: Chart processing (installation, deletion, etc.) may take several minutes depending on the number of charts to be processed.

Note 3: If, when attempting to install charts, nothing appears on the display at the start of the procedure, reset the power and try again.

Note 4: If installation of AVCS charts stops, the message "Chart installation has stopped. Run the installation again. Installation will continue from the chart not yet installed." appears. This does not indicate completion of the installation. Restart the installation. The installation resumes from the chart not yet installed.

This message may also appear when installing C-MAP ENC SERVICE, C-MAP PROFESSIONAL+, C-MAP ENC+ SERVICE or C-MAP ADMIRALTY ENC SERVICE charts if the user does not confirm completion of the installation within approx. one hour. (Installation window remains on the screen.) However, this is not an indication of failed installation.

Note 5: When installing the AVCS LargeMedia, the message "No connection to dongle" may appear in the [Result] window at the completion of the installation. If this occurs, reinstall the media.

3.1 How to Disable the C-MAP Chart Function

The C-Map chart function is active by default. If you do not carry C-Map charts, disable this function as shown below.

Note: When the C-MAP function is disabled, the following functions are not available.

- C-MAP selection on the Filter window (see section 3.15).
 - C-MAP Install/Update History (see section 3.14).
1. Get into the Chart maintenance mode, then click the [License] button on the InstantAccess bar™ to show the [Licenses] dialog box.
 2. Click the [C-MAP] tab to show the [Licenses] dialog box for C-MAP.

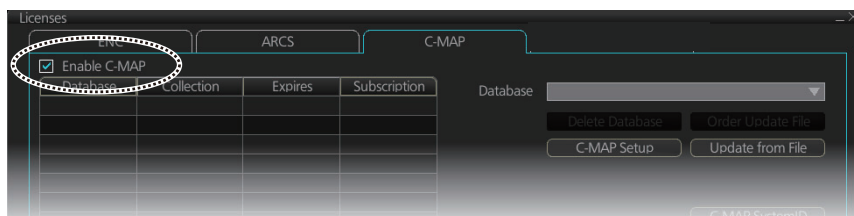

3. Remove the check mark at [Enable C-MAP].
4. The message "You need to reboot for changes to take effect." appears. Click the [OK] button to reboot the system.
If C-MAP charts are installed at a later date, be sure to check the [Enable C-MAP] box to enable the C-MAP function.

3.2 How to Install Public Keys for ENC Charts

Public keys authenticate the source and integrity of the ENC chart materials used in this chart system. Before you install a new ENC chart, confirm that the corresponding public key is installed.

1. Set the medium (DVD, USB flash memory, etc.) that contains the public key. (The IHO public key is pre-installed.)
2. Get into the Chart maintenance mode then click the [Public Key] button on the InstantAccess bar™.

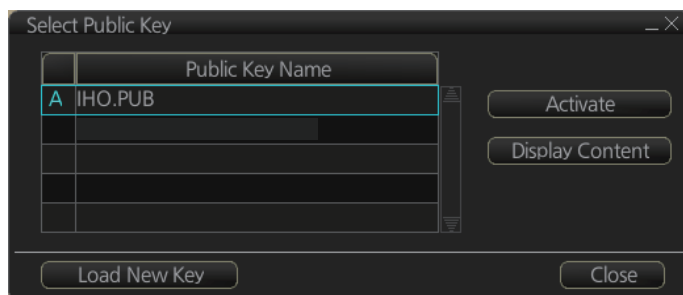

3. Click the [Load New Key] button to show the [Open File] dialog box.
4. Find the .pub file then click the [Open] button. The [Public Key] dialog box reappears.
5. Click the [Display Content] button on the [Public Key] dialog box to show the display contents.

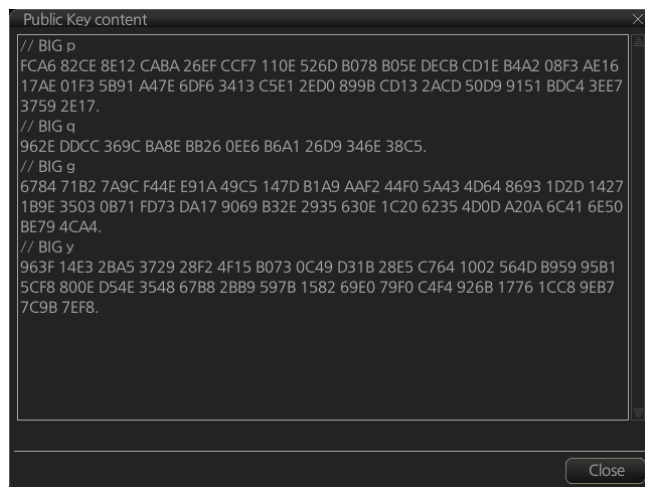

6. To accept the contents, click the [Activate] button on the [Public Key] dialog box.

3.3 How to Install ENC Licenses, Charts

Install your ENC licenses and charts, in that order.

3.3.1 How to install an ENC license

Automatic installation

1. Set the medium (DVD, USB flash memory, etc.) that contains the ENC license.
2. Get into the Chart maintenance mode then click the [License] button on the InstantAccess bar™ to show the [Licenses] dialog box.
3. Click the [Import Licenses] button.

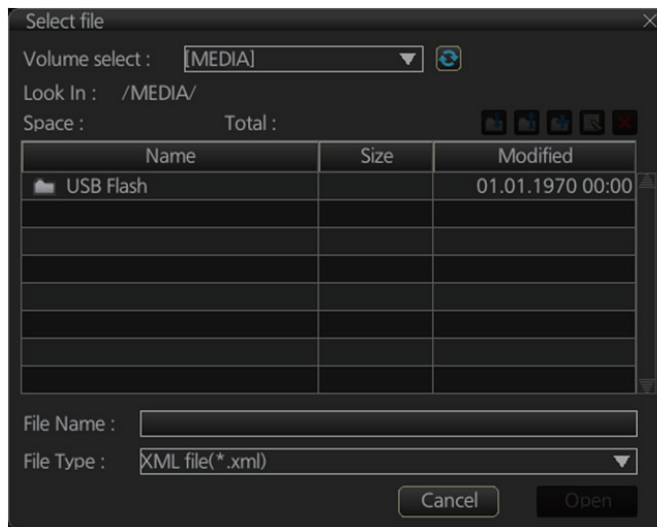

4. Select the medium that contains the license then click the [Open] button.
5. Find the license (permit.txt) then click the [OK] button to install the license. The [Licenses] dialog box then shows cell name, date of expiration, data server name and subscription type of the license.

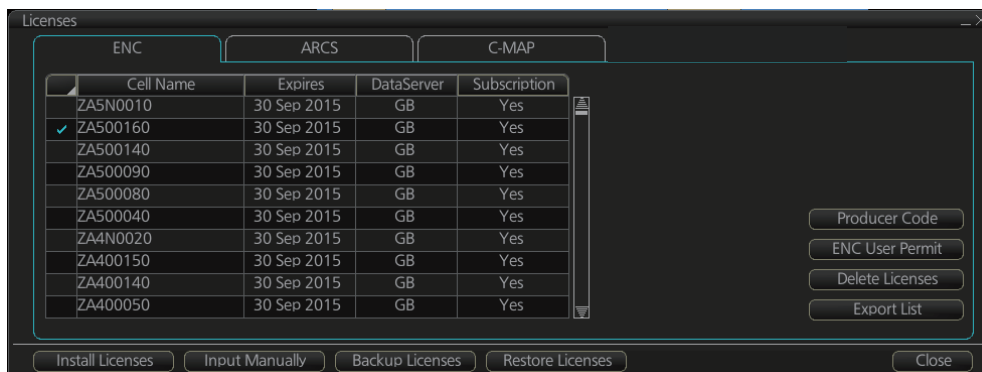

6. Click the [Close] button to finish.

Manual installation

If you do not have the medium which has your ENC license, you can enter the license number manually.

1. Click the [CHARTS] button on the Status bar to go the Chart maintenance mode, then click the [License] button on the InstantAccess bar™.

3. HOW TO MANAGE CHARTS

2. Click the [Input Manually] button to show the [Input License Manually] box.

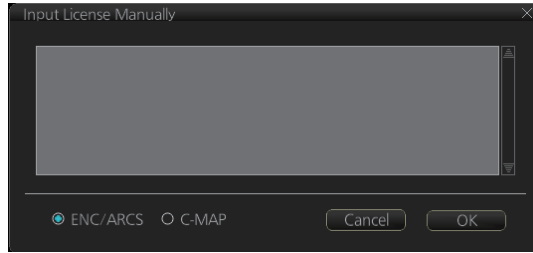

3. Select the type [ENC/ARCS] at the bottom of the screen.
4. Enter the license number(s) then click the [OK] button.

3.3.2 How to install ENC charts

When you install charts from a medium, the system first loads a catalog, which stores certain information into your SSD such as cell IDs, their position, and edition number, from the install medium. Then, the system asks which charts you want to install from the chosen medium. After building the catalog, you can view the contents of it by clicking the [Cell Status] button.

Note 1: Do not cancel the installation (with the [Cancel] button) while it is in progress. Cancellation automatically resets the power, stopping the installation. If the power is reset, try to install the charts again. If the installation fails, reset the power and try again.

Note 2: After a chart installation is done, all routes are reverted to “unchecked”. Redo the route check (with [Check Route] button) on a route before using it for navigation, to confirm that the route is safe against updated charts.

1. Set the medium that contains the ENC charts.
2. Get into the Chart maintenance mode then click the [AUTO Load] button on the InstantAccess bar™. A prompt informs you that it may take a while to do the installation and are you sure to continue. Click the [OK] button to continue. A message informs you that the system is searching the medium (in the figure below the medium is a DVD) for chart data.

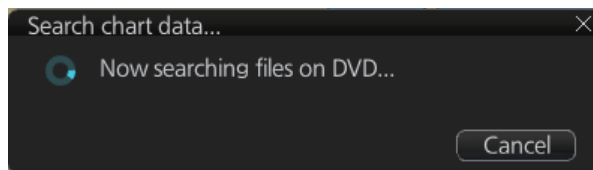

The results of the search are displayed, an example of which is shown below. To cancel the installation, click the [Cancel] button.

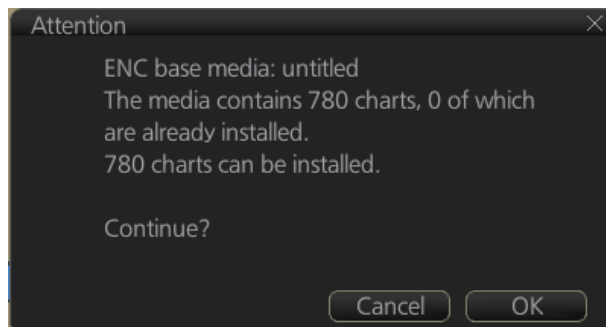

- Click the [OK] button to install the charts. The [Install chart data] window appears and shows the percentage of completion, with digital and analog indications.

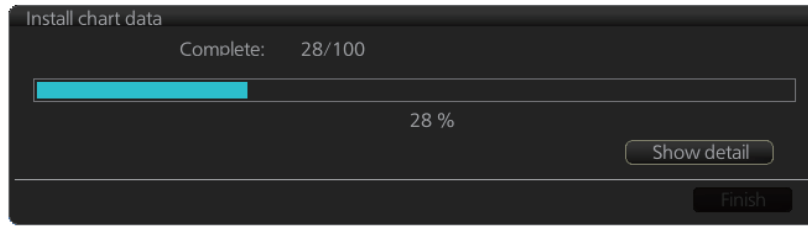

To show details during the installation, click the [Show detail] button.

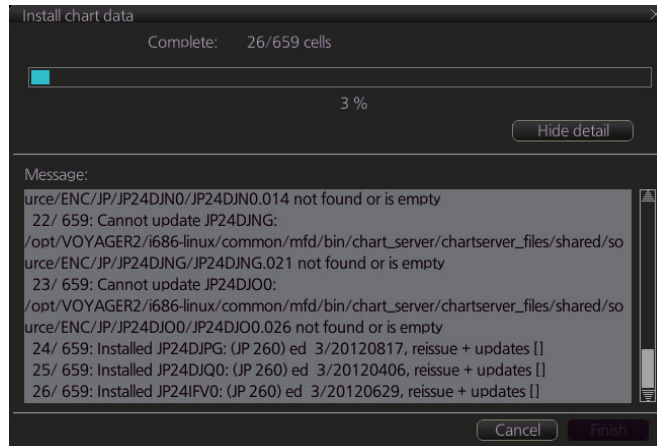

To close the [Message] window, click the [Hide detail] button.

- When the installation is completed, information about the installation appears in the [Error/Warning/Guidance] window. Click the [Confirm] button to finish.
- If applicable, set the next sequential medium and repeat steps 2-4 to install the next charts.
- After all necessary charts are installed, reset the power.

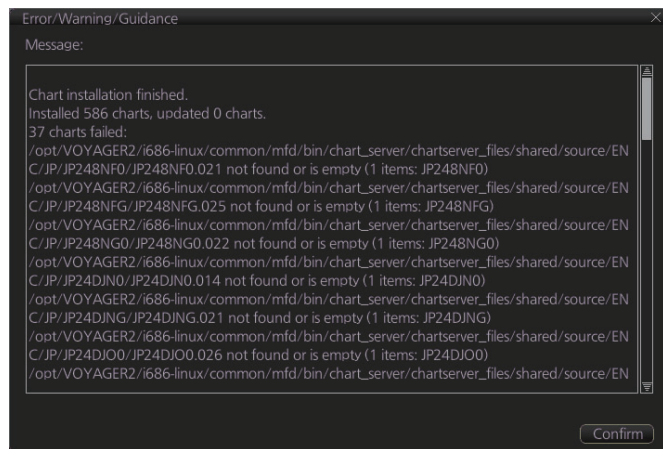

Note 1: When many charts are installed, the ECDIS checks for error in the installed chart data at the next power up. This is not an indication of malfunction.

Note 2: Previous versions of charts cannot be displayed if installed after installing the latest versions.

3.4 How to Install ARCS Licenses, Charts

3.4.1 How to install an ARCS license

An ARCS license can be installed automatically or manually. The procedure which follows is for automatic installation. For manual installation, see "Manual installation" on page 3-3.

Note: Do not cancel the installation (with the [Cancel] button) while it is in progress. Cancellation automatically resets the power, stopping the installation. If the power is reset, try to install the charts again. If the installation fails, reset the power and try again.

1. Insert the medium (DVD, USB flash memory, etc.) that contains the ARCS license.
2. Get into the Chart maintenance mode then click the [License] button on the InstantAccess bar™ to show the [Licenses] dialog box.
3. Click the [Import Licenses] button.

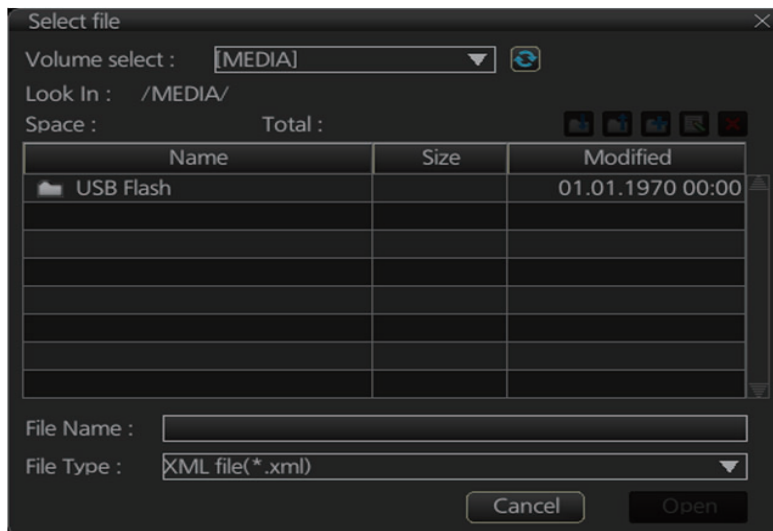

4. Find the medium that contains the license then click the [Open] button.
5. Click the [OK] button to install the license.

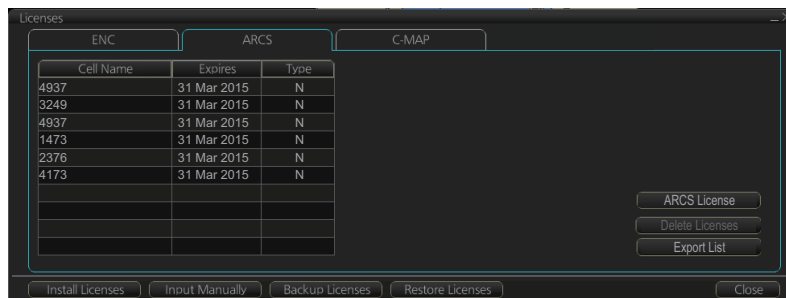

6. Click the [Close] button to finish.

3.4.2 How to install ARCS charts

When you install charts from a medium, the system first loads a catalog, which stores certain information into your SSD such as cell IDs, their position, and edition number, from the install medium. Then, the system asks which charts you want to install from the chosen medium. After building the catalog, you can view the contents of it by clicking the [Cell Status] button.

Note: Do not cancel the installation (with the [Cancel] button) while it is in progress. Cancellation automatically resets the power, stopping the installation. If the power is reset, try to install the charts again. If the installation fails, reset the power and try again.

1. Set the medium that contains the ARCS charts.
2. Get into the Chart maintenance mode then click the [AUTO Import] button on the InstantAccess bar™. A prompt informs you that it may take a while to do the installation and are you sure to continue. Click the [OK] button. A message informs you that the system is searching the medium (in the figure below the medium is a DVD) for chart data.

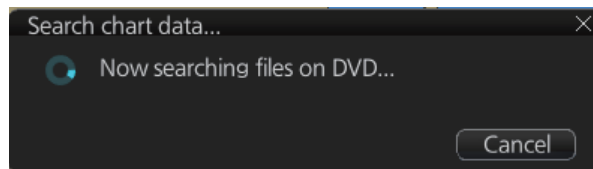

The results of the search are displayed, an example of which is shown below. To cancel the search, click the [Cancel] button.

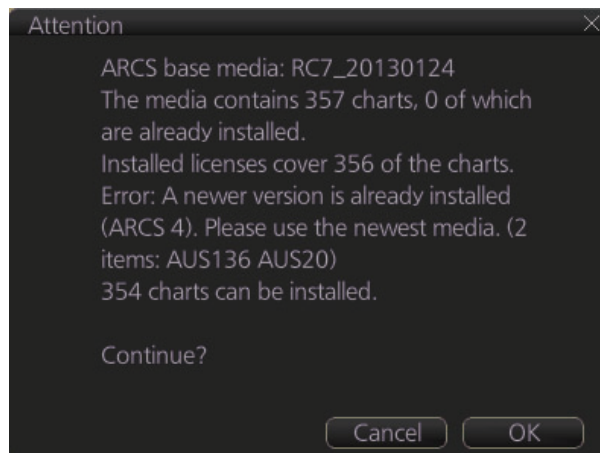

3. Click the [OK] button to install the charts. The [Install chart data] window appears and shows the percentage of completion, with digital and analog indications.

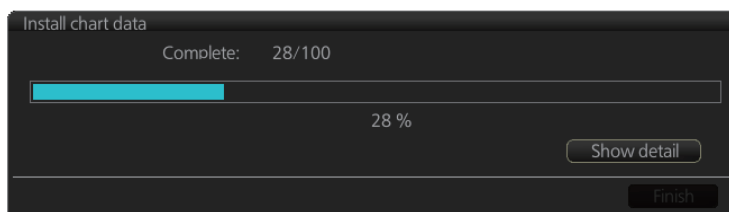

3. HOW TO MANAGE CHARTS

To show details during the installation, click the [Show detail] button.

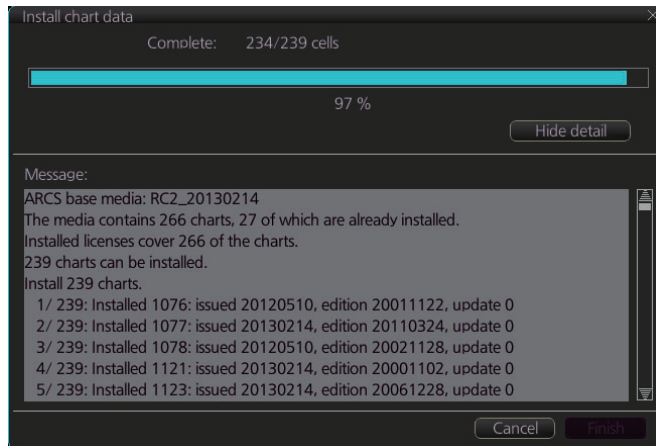

To close the [Message] window, click the [Hide detail] button.

4. When the installation is completed, information about the installation appears in the [Error/Warning/Guidance] window. Click the [Confirm] button to finish.

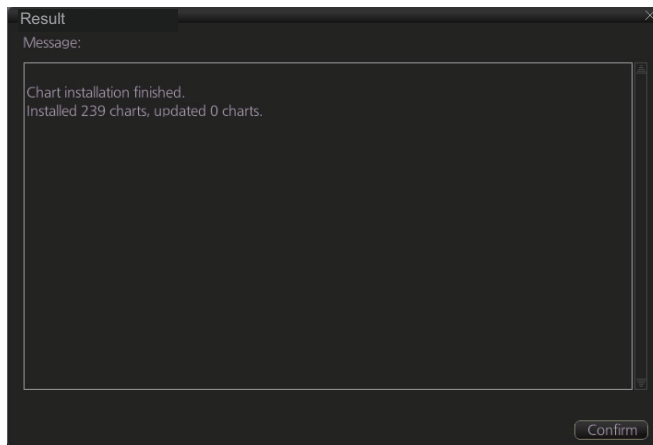

5. If applicable, set the next sequential medium then repeat steps 2-4 to install the next charts.
6. After all necessary charts are installed, reset the power.

Note 1: When many charts are installed, the ECDIS checks for error in the installed data at the next power up. This is not an indication of malfunction.

Note 2: If, after installation, no ARCS chart appears, delete all ARCS charts and then reinstall them.

3.5 How to Delete ENC, ARCS Licenses

1. Get into the Chart maintenance mode.
2. Click the [License] button on the InstantAccess bar™.
3. Click the [ENC] or [ARCS] tab as appropriate to show a list of licenses.

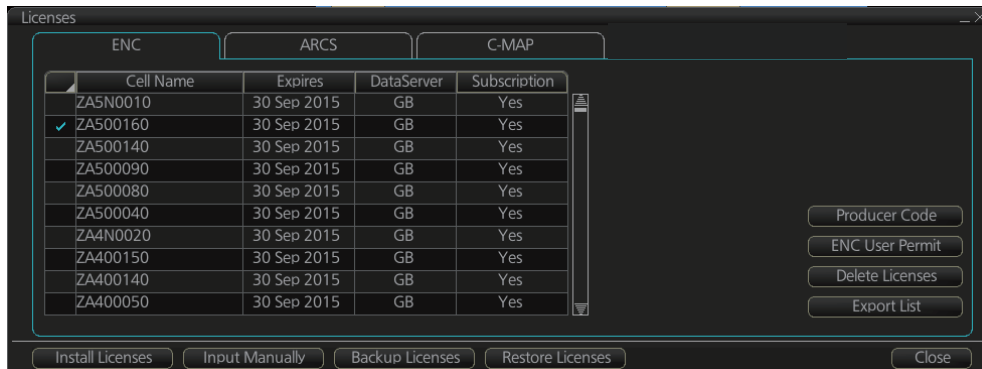

4. Put a checkmark next to the license(s) to delete.
5. Click the [Delete Licenses] button to delete the license(s) selected.

3.6 How to Update ENC Chart Manufacturer Info

An ENC chart has official or unofficial attributes. You can determine if an ENC chart is official or unofficial by viewing the chart manufacturer's information. Manufacturer's information has the following functions.

- [Filter] window (see section 3.15) can show or hide official or unofficial charts.
- Chart judgment with chart alert (see section 8.1.2). (Unofficial charts are subject to chart alert.)
- Unofficial charts are denoted on the [Check Results] of the [Route Plan] dialog box (see section 9.4.5) if the corresponding alert check is active.



The ENC manufacturer information can be updated as follows.

Note 1: ENC chart manufacturer information is built in the FMD beforehand, and it is not normally necessary to update the information.

Note 2: The ENC chart manufacturer information file has its own format. For details, contact a FURUNO dealer.

1. In the Chart maintenance mode, click the [License] button to show the [Licenses] dialog box.
2. Click the [ENC] tab.

3. HOW TO MANAGE CHARTS

3. Click the [Producer Code] button.

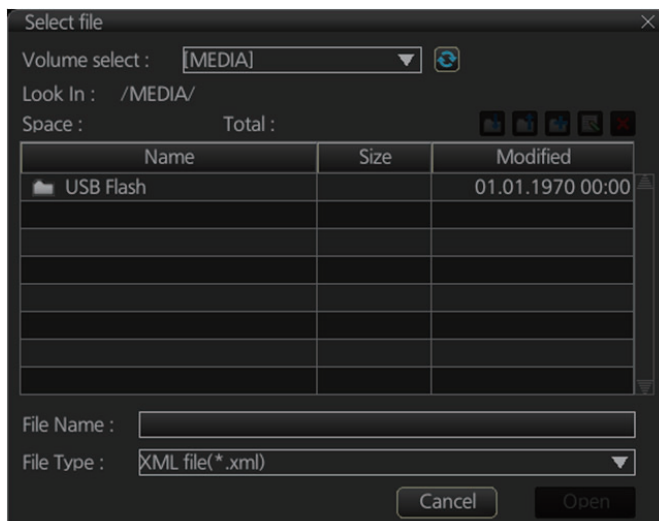

4. Select the ENC chart manufacturer information file then click the [Open] button.
5. Reset the power.

3.7 How to Install C-MAP Charts

Synchronize chart data before you install C-MAP charts, grouping the ECDIS units to synchronize, otherwise the chart data cannot be shared. See the procedure in section 3.22.1 for how to synchronize chart data. If C-MAP charts are not synchronized after installation, delete all C-MAP charts, and do the above procedure again.

3.7.1 How to register the eToken

The eToken is a hardware mechanism (installed inside the PCU) used for password authentication. Registration of the eToken is required only once, before you install the C-MAP database.

1. Get into the Chart maintenance mode then click the [License] button on the InstantAccess bar™ to show the [Licenses] dialog box.
2. Click the [C-MAP] tab to show the [Licenses] dialog box for C-MAP.

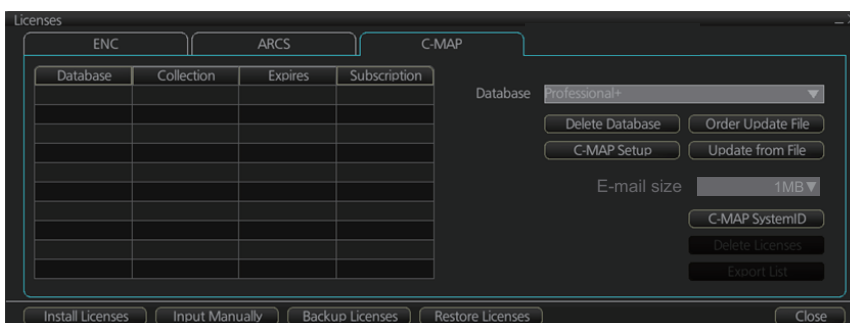

3. Click the [C-MAP Setup] button.
4. You are asked if you are sure to continue; click the [OK] button to continue and register the eToken.

Note 1: "CMAP: No connection to eToken" disappears from the Permanent warning box after completion of the registration.

Note 2: You can show your C-MAP system ID by clicking the [C-MAP System ID] button on the [Licenses] dialog box for C-MAP.

C-MAP system ID appears here.



3.7.2 How to install the C-MAP database, licenses

When you install the C-MAP database from a medium, all data is saved to the SSD.

Note 1: To share C-MAP charts between several ECDIS units, group the units before you install the C-MAP charts. If the grouping is not done before chart installation, the charts are not shared. In this case, remove the C-MAP charts, group the ECDIS units, then re-install the C-MAP charts.

Note 2: The installation of a chart cannot be cancelled while it is in progress. If you get an error message, try to install the charts again.

Note 3: The C-MAP database in the units selected for synchronization are synchronized at the successful completion of the database installation.

How to install the C-MAP database

1. Insert the medium that contains the C-MAP database.
2. Get into the Chart maintenance mode then click the [AUTO Import] button on the InstantAccess bar™.

The [Install chart data] window appears and shows the percentage of completion, with digital and analog indication.

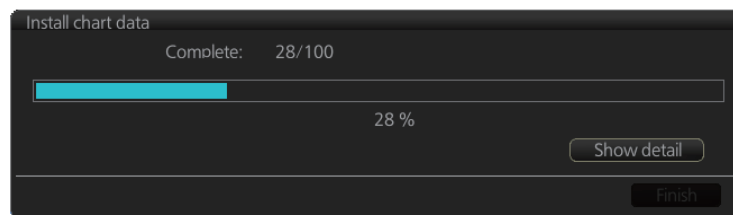

To show details during the installation, click the [Show detail] button.

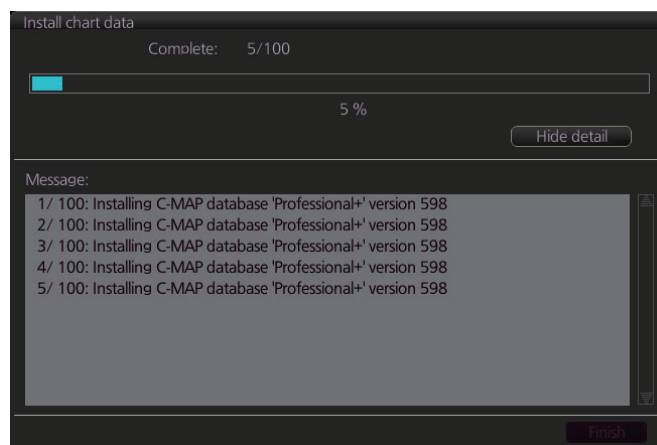

To close the [Message] window, click the [Hide detail] button.

3. HOW TO MANAGE CHARTS

3. When the installation is completed, information about the chart database installed appears in the [Error/Warning/Guidance] window. Click the [Confirm] button to finish.

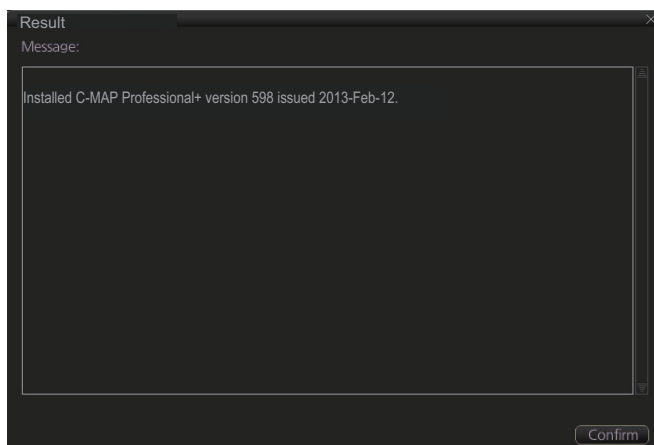

4. If applicable, set the next sequential medium and repeat steps 2-4 to install the next databases.
5. After all necessary databases are installed, reset the power.

Note 1: If, after installation, C-MAP PROFESSIONAL+ charts do not appear, delete all corresponding charts and then reinstall them.

Note 2: Synchronization is not done for charts which could not be installed successfully. Reinstall failed charts.

How to install C-MAP licenses

A C-MAP license file is normally installed automatically. Manual installation is also available.

Automatic installation:

1. Set the medium (DVD, USB flash memory, etc.) that contains the C-MAP license.
2. Get into the Chart maintenance mode then click the [License] button on the InstantAccess bar™.
3. Click the [Import Licenses] button.
4. Select the medium that contains the license then click the [Open] button.
5. Click the [OK] button to install the license.
6. Click the [Close] button to finish.
7. Reset the power.

Manual installation:

1. Click the [CHARTS] button on the Status bar to go the Chart maintenance mode, then click the [License] button on the InstantAccess bar™.
2. Click the [Input Manually] button to show the [Input License Manually] box.
3. Select the type [C-MAP] at the bottom of the window.

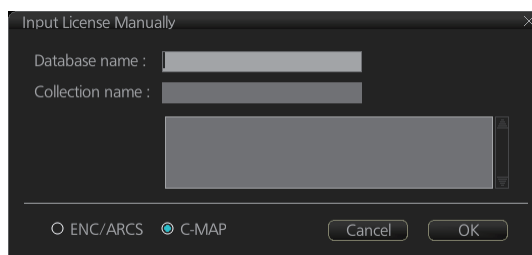

- Enter the [Database name] and [Collection name] information as shown in the table below. Enter the names exactly as shown to ensure correct installation.

Chart Type	Information to enter	
	Database name	Collection name
PROFESSIONAL+	Professional+	Enter "Zone *" (without quotations; "*" indicate the Zone number). Ex. Zone 1
ENC SERVICE	ENC	Enter "Zone * ENC" (without quotations; "*" indicate the Zone number). Ex. Zone 1 ENC
ENC+ SERVICE	ENC+	
ADMIRALTY ENC SERVICE	CAES	Enter the licensed collection name.

- Enter the license (max. 16 characters) in the bottommost window.
- Click the [OK] button to finish.
- Reset the power.

3.7.3 How to generate, order and apply an update file

How to generate and order an update file

To update the C-MAP chart database, you have to generate an update file, and e-mail the file directly to C-MAP. The update file defines coverage of charts you can display on your chart radar.

- Connect a USB flash memory to the USB port on the Control Unit.
- Get into the Chart maintenance mode then click the [License] button on the InstantAccess bar™.
- Click the [C-MAP] tab to show the [Licenses] dialog box for C-MAP.
- From the [E-mail Size] drop-down list, select the size of the update file. The choices are [100KB], [200KB], [300KB], [400KB], [500KB], [750KB], [1MB], [2MB], [3MB], [4MB], [10MB], [Unlimited]. This is the size of the data file in an e-mail. The file may be sent in pieces depending of the size selected.
- Click the [Order Update File] button. A file name (C-MAP system ID and chart type) is automatically created, with the extension .ord.

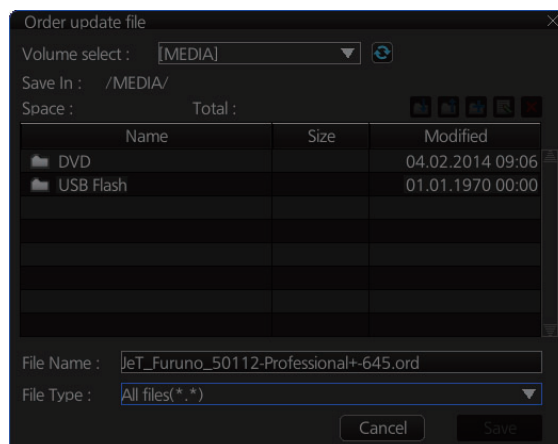

- Select the USB flash memory.
- Click the [Save] button to save the order file to the USB flash memory.

3. HOW TO MANAGE CHARTS

8. Send the order file to updates@c-map.no.

Within a few minutes you will receive a file that includes the terms for using the chart service and the chart updates. Save the file to a USB flash memory and apply it as shown in the next section.

How to apply the update file

1. Insert the USB flash memory that contains the update file (.ans extension) into the USB port on the Control Unit.
2. Get into the Chart maintenance mode then click the [License] button on the InstantAccess bar™.
3. Click the [C-MAP] tab to show the [Licenses] dialog box for C-MAP.
4. Click the [Update from File] button.
5. Find the update file on the USB flash memory then click the [Open] button.

3.7.4 How to confirm license status

If you cannot display a C-MAP chart, follow the procedure below to check license status. Database and license should be installed beforehand.

1. Get into the Chart maintenance mode, then click the [License] button on the InstantAccess bar™.
2. Click the [C-MAP] tab to show the [Licenses] dialog box for C-MAP.
3. Click the [Check Signature] button. The results of the check appear in the [Result of Check Signature] window, as [ok] or [Not ok]. For [Not ok], contact your C-MAP dealer or C-MAP chart sales outlet for advice.
4. Click the [OK] button to close the window.

3.8 How to Delete a C-MAP Database

If you are going to delete all C-MAP databases, turn off chart synchronization and delete the databases from each processor unit.

1. Get into the Chart maintenance mode then click the [License] button on the InstantAccess bar™.
2. Click the [C-MAP] tab to show the [Licenses] dialog box for C-MAP.
3. Select the database to delete with the [Database] pull-down list.
4. Click the [Delete Database] button, then reset the power.

3.9 How to Export a List of Charts

Get into the Chart maintenance mode, click the [Manage Charts] button on the InstantAccess bar™ to show the [Manage Charts] dialog box. Check the charts to add to the list. Click the [Export List] button to export the checked charts to a USB flash memory, in .txt format.

3.10 How to Export a List of Specific Licenses

You can export a list of your ENC, ARCS or C-MAP licenses to a USB flash memory, in .txt format.

1. Set a USB flash memory in a USB port on the PCU.
2. Get into the Chart maintenance mode then click the [License] button.
3. Click the [ENC], [ARCS] or [C-MAP] tab.
4. Click the [Export List] button.
5. Change the file name at [File Name] if desired.
6. Select the USB flash memory then click the [Save] button.
7. Click the [OK] button to finish.

3.11 How to Show the ENC Permit, ARCS License

1. Get into the Chart maintenance mode then click the [License] button.
2. Click the [ENC] or [ARCS] tab as applicable.
3. Click the [ENC User Permit] or [ARCS Licenses] button as applicable to show permit or license. Click the [OK] button to finish.

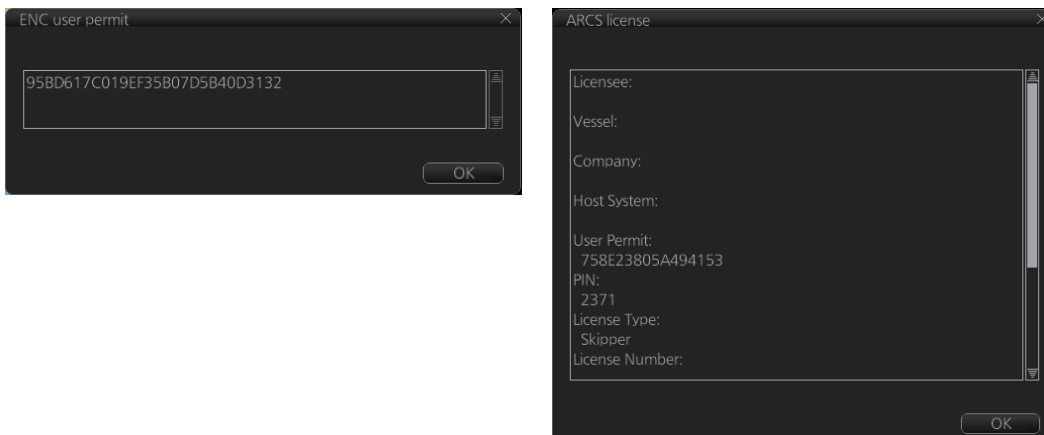

3.12 How to Backup, Restore Licenses

You can make backup copies of your ENC, ARCS and AVCS (AIO) licenses and save them to a USB flash memory. If re-installation of the licenses becomes necessary, you can reinstall them from the USB flash memory. The backup and restore functions are not available with C-MAP charts.

To backup licenses:

1. Insert a USB flash memory into the USB port on the PCU.
2. Get into the Chart maintenance mode then click the [License] button on the InstantAccess bar™ to show the [Licenses] dialog box.
3. Click the [Backup Licenses] button.
4. Select the USB flash memory then click the [OK] button to save the licenses.

To restore licenses:

1. Insert the USB flash memory that has the licenses into the USB port on the PCU.
2. Get into the Chart maintenance mode then click the [License] button on the InstantAccess bar™ to show the [Licenses] dialog box.
3. Click the [Restore Licenses] button.
4. Select the licenses from the USB flash memory then click the [OK] button.

3.13 How to View Permit Expiration Date

Permits are used to control the right to use chart data in the ECDIS. A permit is connected to the edition of a chart. Permits are issued in two different types:

- **Subscription permit:** This type of permit includes updates for subsequent 3, 6, 9 or 12 months.
- **One-Off permit:** This type of permit includes only updates up to the issue date of the permit.

The expiry date of a permit controls the loading of Base charts and their updates to the chart. The system will warn you when you are installing charts or updates that are issued less than 30 days before the expiration date of a permit. If a permit has expired, it is impossible to install a chart or its update that was issued after the expiration date of the permit. The user has a right to view a chart forever, except C-MAP charts that have viewing periods which end two months after the expiry date of the license. If the charts are not updated regularly it will not complete the requirements for having up-to-date charts. To view the permit status of a chart, click the [License] button on the InstantAccess bar™ and then click the applicable "chart" tab ([ENC], [ARCS], or [C-MAP]).

The example below shows the status of ENC charts. The expiration date of each cell appears in the [Expires] window.

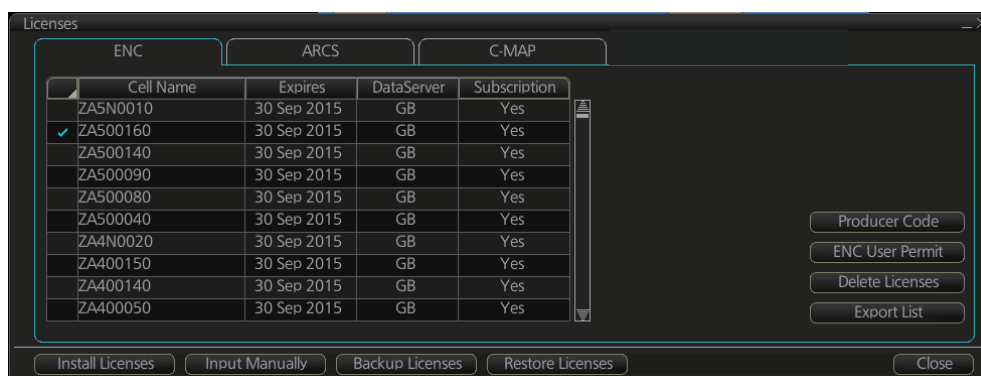

Subscription warnings for RENC

If you have at least one subscription-type permit, the system will automatically warn you about the expiration date of your subscription license, in the Permanent warning box.

Note: If you change service provider for some reason, it is recommended that you remove all the charts from the ECDIS before installing new charts of new service provider.

3.14 How to Display Install/Update History

You can see a history of chart installations and updates. On the InstantAccess bar™, click the [Log] and [Update Log] buttons followed by the [ENC], [ARCS] or [C-MAP] button. The example below shows the install/update history for ENC charts.

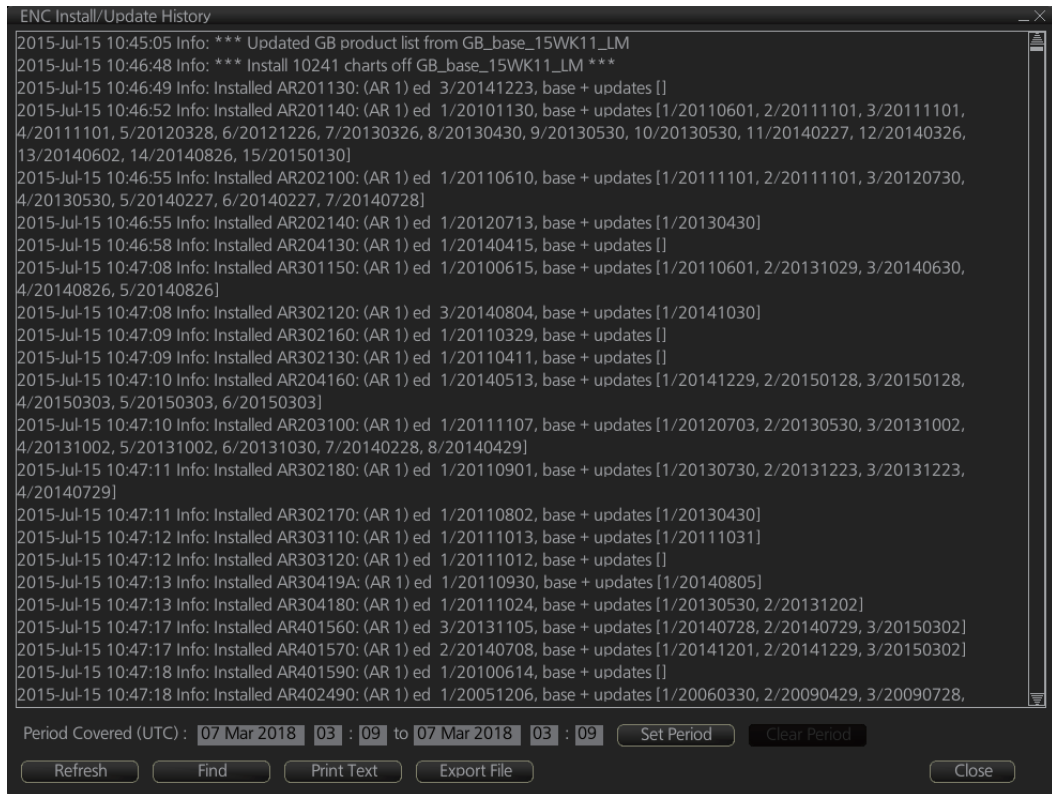

You can filter the log with [Period Covered (UTC)]. Enter the period to display then click the [Set Period] button. Click the [Clear Period] button to display all entries. The [Refresh] button updates the list. [Print Text] prints hard copy of the history. [Export File] exports the log file. The file name "UpdateLog_***YYYYMMDDhhmmss.txt" is automatically assigned. (***=ENC, ARCS, or CMAP)

The [Find] button searches required text string as follows:

- 1) Click the [Find] button to show the [Find text] box.

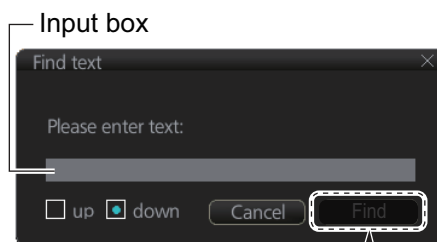

Enter text in box and [Find] button appears.

- 2) Click the input box then enter the text to search.
- 3) Select the search direction with the up or down radio button.
- 4) Click the [Find] button. The first matching text is highlighted in yellow at the top of the screen.
- 5) To continue the search click the [Find] button. To cancel the search, click the [Cancel] button.

3.15 Catalog of Chart Cells

A catalog is used to view graphical coverage of the charts stored in your SSD. Available charts are displayed using their limits of charts. Note that sometimes the real coverage of the charts may be considerably less than the declared limits of it.

To display the catalog, get into the Chart maintenance mode then click the [Manage Charts] button on the InstantAccess bar™. The [Filter] window lets you choose what to display. Check or uncheck items as appropriate.

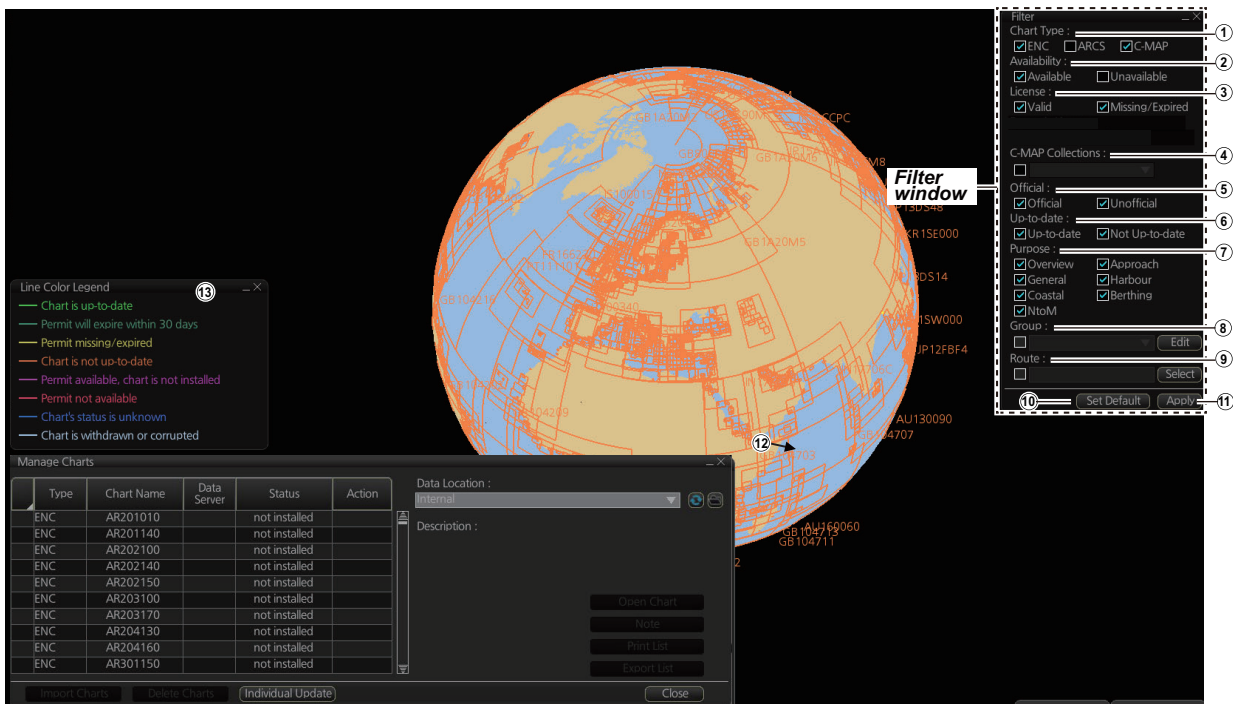

- 1) Chart Type
 [ENC]: Display ENC charts.
 [ARCS]: Display ARCS charts.
 [C-MAP]: Display C-MAP charts.
- 2) Availability
 Display available or unavailable charts.
- 3) License
 [Valid]: Cell with valid license.
 [Missing/Expired]: Cell with missing or expired license.
 [Valid + Missing/Expired]: Display cell regardless of license.
 [Uncheck both]: Hide all cells.
- 4) C-MAP Collections
 A collection is a pre-defined dataset, the contents of which can be defined by zone, individual chart or any of those combinations. Applicable to C-MAP charts also.
Note: This item is greyed out when C-MAP charts are not used.
- 5) Official
 Display official or unofficial charts.
- 6) Up-to-date
 Display charts which are or are not up to date.

- 7) Purpose
Display chart according to its purpose - Overview, General, Coastal, NtoM, Approach, Harbour, Berthing.
- 8) Group
See the next section for how to group charts.
- 9) Route
The cells within a route and route waypoints (start and end points settable) are shown. When checked, the [Action] column of the [Manage Charts] dialog box shows the necessary action to be taken for each chart within the specified route in order to navigate the route.

Action	Description
[install]	License is installed, however the chart has not been installed. Install the chart.
[no action]	The latest chart is installed, and the license expiration date is 30 or more days away.
[order]	License not purchased. Order the license.
[reinstall]	The chart is corrupted. Reinstall the chart.
[remove]	Chart status is "withdrawn". It is not necessary to purchase the license.
[renew]	The latest chart is installed, however the license expires within 30 days. Purchase the license.
[update]	Chart is not up-to-date. Install the latest chart.

Further, the range of the cell (square region) and the range in which the cell has actual data do not necessarily match. If the cell has not been purchased, the cell range is filtered, and if it has been purchased, the actual data range is filtered.

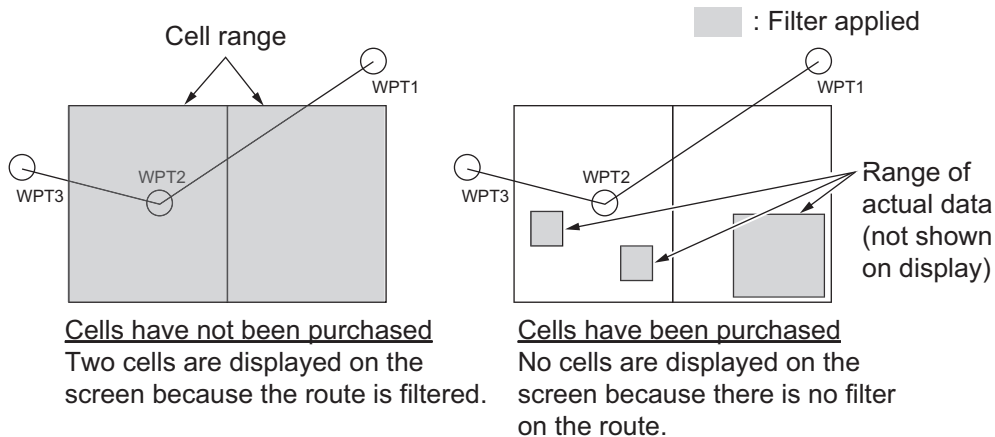

- 10) [Set Default] button
Restores all factory defaults for items in the window.
- 11) [Apply] button
Changes made to the filter window are applied to the chart. This button is only visible if changes are made to the filter window settings.
- 12) Chart boundary boxes
Defines the area covered by a chart and are color-coded according to license and permit status.

3. HOW TO MANAGE CHARTS

13) Line color legend

The line color legend provides information about license validity.

Color	Message	Color	Message
Internal charts		External charts	
Green	Chart is up-to-date	Green	Already installed and up-to-date
Dark Green	Permit will expire within 30 days	Yellow	Can be installed/updated but a warning
Yellow	Permit missing/expired	Orange	Already installed but not up-to-date
Orange	Chart is not up-to-date	Magenta	Can be installed/updated
Magenta	Permit available, chart not installed	Red	No valid permit
Red	Permit not available	Gray	Cannot be installed/updated
Blue	Chart's status is unknown		
Gray	Chart is withdrawn or corrupted		

3.15.1 How to group chart cells

You can define groups of like-format chart cells. This means you can collect related charts, for example, all cells that cover a route from Liverpool to New York or all cells available from a National Hydrographic Office.

You can make a group and define charts from the [Edit Group] dialog box.

How to make a new group of chart cells

1. In the Chart maintenance mode, click the [Manage Charts] button on the InstantAccess bar™.
2. Click the [Edit] button in the [Filter] window to show the [Edit Group] dialog box.



3. Click the [New] button.
4. In the [Outside Group] window, click the box to the left of the chart cell you want to add to the group to show a checkmark. (A context-sensitive menu with "Select all" and "Deselect all" functions is available by right-clicking the box to the left of [Name], in either window.)
5. After you have selected the cells to add to the group, click the << button to move the names of the selected cells to the [Inside Group] window. If you want to remove a chart from the group, select it then click the >> button.
6. Click the [Save] button.
7. Enter a name for the group, using the software keyboard, then click the [OK] button.
8. Click the [Close] button to finish.

How to edit a group of chart cells

You can edit a group of chart cells from a group as follows:

1. In the Chart maintenance mode, click the [Manage Charts] button on the InstantAccess bar™ to show the [Filter] window.
2. Click the [Edit] button.
3. At the item [Group Name], select the name of the group with the pull-down list.
4. In the [Inside Group] window, click the box to the left of the chart cell you want to remove from the group to show a checkmark. (A context-sensitive menu with "Select all" and "Deselect all" functions is available by right-clicking the box to the left of [Name].)
5. After you have selected the charts to remove to the group, click the >> button to remove the selected charts cells from the group.
6. Click the [Save] button to finish.

How to delete a group of chart cells

You can delete group of chart cells as follows:

1. In the Chart maintenance mode, click the [Manage Charts] button on the InstantAccess bar™ to show the [Filter] window.
2. Click the [Edit] button.
3. Select the name of the group with the pull-down list at the item [Group Name].
4. Click the [Remove] button.
5. Click the [OK] button.
6. Click the [Close] button.

How to select the group to view

In the Chart maintenance mode, click the [Manage Charts] button on the InstantAccess bar™ to show the [Filter] window. Check [Group] then select the group to view from the pull-down list at [Group].

3.15.2 How to view status of chart cells

The [Cell Status] dialog box shows the status of the chart cells stored in the system. To show this dialog box, get into the Chart maintenance mode then click the [Cell Status] button on the InstantAccess bar™.

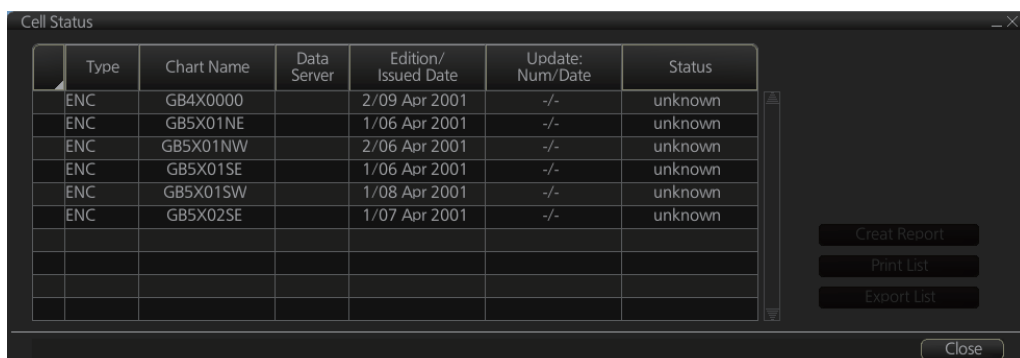

Type	Chart Name	Data Server	Edition/Issued Date	Update: Num/Date	Status
ENC	GB4X0000		2/09 Apr 2001	-/-	unknown
ENC	GB5X01NE		1/06 Apr 2001	-/-	unknown
ENC	GB5X01NW		2/06 Apr 2001	-/-	unknown
ENC	GB5X01SE		1/06 Apr 2001	-/-	unknown
ENC	GB5X01SW		1/08 Apr 2001	-/-	unknown
ENC	GB5X02SE		1/07 Apr 2001	-/-	unknown

3. HOW TO MANAGE CHARTS

- **Type:** Type of chart cell, ENC, C-MAP or ARCS.
- **Chart Name:** Chart name
- **Data Server:** The name of the data server where the chart was downloaded from.
- **Edition/Issue Date:** Edition no. and issued date of the chart cell.
- **Update: Num/Date:** No. and date of the update of the chart cell.
- **Status:**
 - [up to date]: Cell is up-to-date.
 - [not up to date]: Cell is not up-to-date.
 - [not installed]: Cell is not installed.
 - [withdrawn]: Cell has been withdrawn (cell will not be updated).
 - [unknown]: Cell is not delivered as part of a data server service (ex. unencrypted ENC).
 - [broken]: Cell is corrupted.

3.16 How to Open Charts

In the Chart maintenance mode, click the [Manage Charts] button on the InstantAccess bar™ to display the dialog box shown below. Select the chart to open then click the [Open Chart] button.

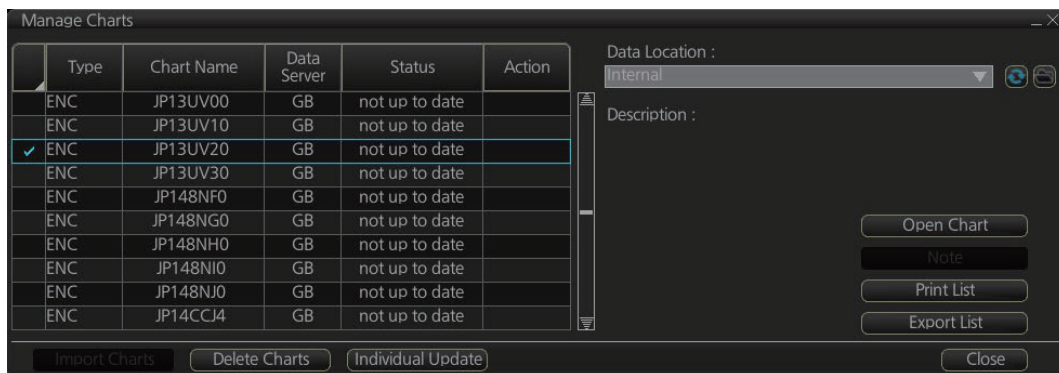

3.17 How to Print Chart List, Cell Status List

3.17.1 How to print the chart list

1. In the Chart maintenance mode, click the [Manage Charts] button on the InstantAccess bar™ to show the [Manage Charts] dialog box.
2. On the [Filter] window, check the information to print.
3. Check the charts to print on the [Cell Status] dialog box.
4. Click the [Print List] button to print. (If you have selected more than 30 charts, the message "The number of pages is 1. Do you want to continue?." appears. Click the [OK] button to continue, or the [Cancel] button to escape.)

Chart Management Report			
Ship Name:		Call Sign:	
IMO Number:		MMSI Number:	
Printing Date:	2013-06-18 21:14:00		
Data Location:	Internal		
Filter			
Chart Type:	ENC/ARCS/C-MAP	Availability:	Available
License:	Valid/Missing/Expired	Dynamic License:	DL/Non-DL
Official:	Official/Unofficial	Up-to-date:	Up-to-date/Not Up-to-date
Purpose:	Overview/General/Coastal/Approach/Harbour/Berthing		
Group:	test_all		
Status Summary			
yes		1251/1884	
no		633/1884	
Type	Chart Name	Data Server	Status

ENC	AU130060	GB	yes
ENC	AU130090	GB	yes
ENC	AU130120	GB	yes
ENC	AU130150	GB	yes

Description of chart list printout

Item	Description
Ship Name	Name of ship
IMO Number	Ship's IMO number
Call Sign	Ship's call sign
MMSI	Ship's MMSI number
Printing Date	Date list printed
Data Location	Location of charts; normally "Internal".
Filter	Settings of the items in the [Filter] window.
Status Summary	[yes]: charts with yes status/total number of charts [no]: charts with no status/total number of charts

3.17.2 How to print the cell status list

1. In the Chart maintenance mode, click the [Cell Status] button on the InstantAccess bar™ to show the [Cell Status] dialog box.
2. On the [Filter] window, check the information to print, then click the [Apply] button. The items selected here appear in the [Cell Status] dialog box.
3. Click the [Create Report] button to generate the report. A report for all cells shown in the [Cell Status] dialog appears.

Note: If there are no cells shown in the [Cell Status] dialog box, the [Create Report] button is not available.

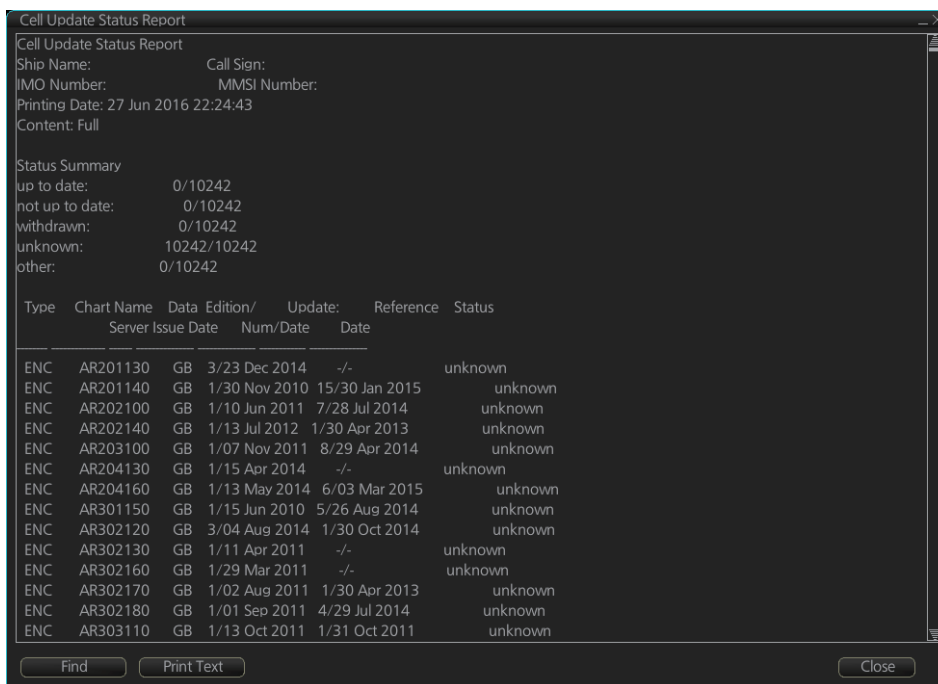

4. Click the [Print Text] button to print.

Description of cell status printout

Item	Description
Ship Name	Name of ship
IMO Number	Ship's IMO number
Call Sign	Ship's call sign
MMSI	Ship's MMSI number
Printing Date	Date list printed
Content	[Full]: A full list of charts, based on the filter settings. [Filtered for Route Plan]: Where a route is selected at the filter settings, this indication appears with the route name.
Status Summary	[up to date]: number of up to date charts [not up to date]: number of charts that are not up to date [withdrawn]: number of withdrawn charts [unknown]: number of charts with unknown status [other]: number charts that are broken, etc.

3.18 How to Delete Charts

If you are going to delete all charts, turn off chart synchronization and delete charts from each processor unit.

1. Click the [Manage Charts] button to show the [Manage Charts] dialog box.
2. Click the block to the left of a chart to show a checkmark. (A context-sensitive menu with "Select all" and "Deselect all" functions is available by right-clicking the block to the left of "Type".)
3. After selecting the chart(s) to delete, click the [Delete Charts] button.
4. Reset the power.

3.19 How to Show Publishers Notes for ENC Charts

You should read the text file associated with each catalog, which you can view when installing a chart from a medium. Click the [Note] button in the [Manage Charts] dialog box. You can print a hard copy with the [Print Text] button.

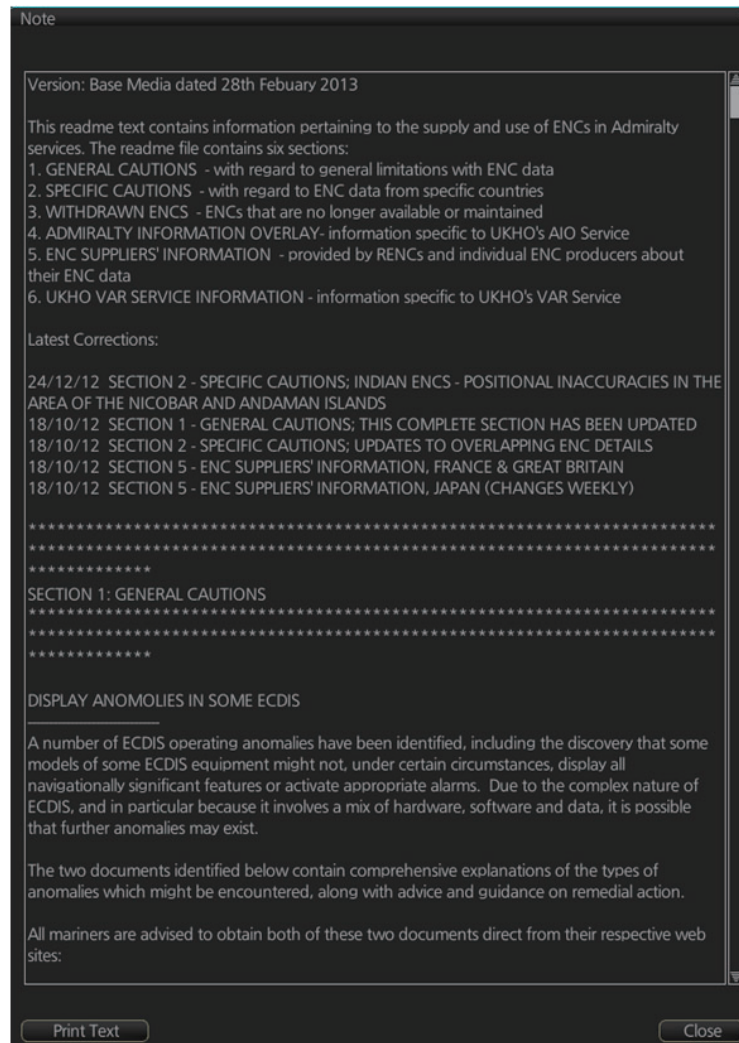

3.20 How to Find the Chart Type

The electronic chart system can display more than one ENC chart cell at a time. This feature is called multi-cell display. If one ENC chart cell does not cover the whole display, the system opens more ENC chart cells for display, if appropriate cells for the displayed area are available. The Own ship functions box shows information about ENC chart cells displayed on the electronic chart display area. When automatic TM reset is active, the information is displayed with reference to your ship's position. If TM reset is OFF, the information is displayed with reference to current cursor position.

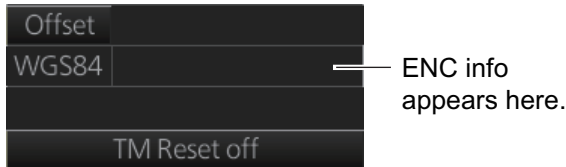

Chart type indication

No indication (Official ENC chart)

“Non-ENC data” (Unofficial ENC chart, indication in yellow)

“ENC data available” (Currently, RNC chart is in use, but ENC material is available. Indication shown in yellow.)

3.21 How to Update ENC, C-MAP Charts Manually

Manual update may include deleting an already existing object, modifying a position or other characteristics of an already existing object or inserting of a new object. In this system, manual updates are stored in a common database.

Mariners cannot permanently remove any of the official objects from the chart display. If a mariner needs to make obsolete any of the official objects he “deletes” them. Then, in practice, the deleted objects are still visible, but a diagonal line on the object indicates it is a deleted object.

However, a mariner can remove objects that he has inserted himself.

Note that the manual updates have no automatic connection to any automatic update received later for charts. If a manual update itself became obsolete, because the official chart has been updated to include the update defined as a manual update, the mariner must himself delete the obsolete manual update in question.

The system records complete usage of manual updates. All deletions, modifications and insertions are recorded and time stamped. If the mariner wishes to see what kind of manual updates he had in the past, for example, two weeks ago, he uses Update History to specify the relevant date range. For information on how to set Display date and Update Review dates, see section 5.2.3.

Note 1: Do not manually update charts while charts are being synchronized. Wait until synchronization is completed.

Note 2: When any chart is updated, all checked routes are reverted to unchecked status. Use the [Check Route] button on the [Alert Parameters] page to re-check routes before starting any voyage.

Note 3: Updated areas in ARC charts are shown with a diagonal line.

3.21.1 How to insert update symbols

An update symbol can be added as shown in the procedure below.

Note 1: If the system freezes when updating the drawing type [area], reset the power.

Note 2: An update symbol that straddles the international date line cannot be edited. In this case, insert the same symbol on each side of the line.

Note 3: Do not do manual updating during chart synchronizing. Do the updating after the completion of synchronizing or do the updating where the chart is installed.

1. Go to the Voyage navigation mode.
2. Click the [Manual Update] button on the InstantAccess bar™ to open the [Manual Update] dialog box.
3. Click the [Planning] tab.

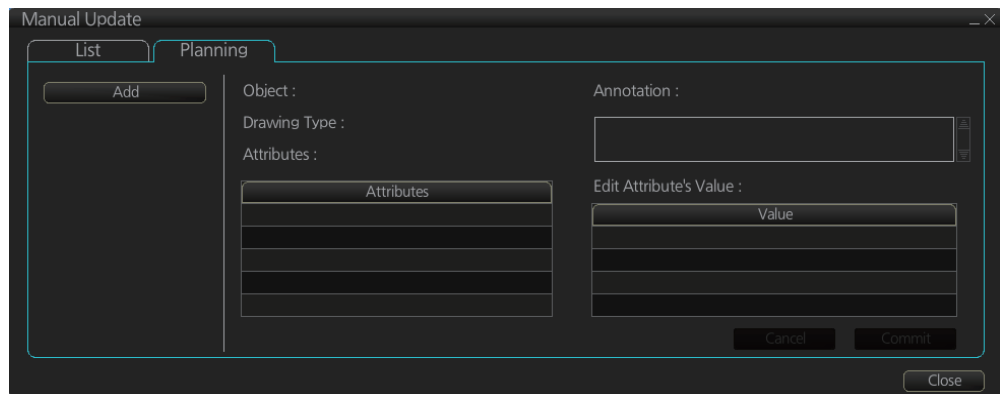

4. Click the [Add] button.

Note: This window can also be shown from the context-sensitive menu. Right-click the display area then select [Manual Update] and [Add New].

5. Use the [Drawing Type] pull-down list to select drawing type: point, line or area.
6. Click desired object.
7. Put the cursor on the location where to insert the symbol then left click. The [Manual Update] dialog box shows:

- Object
- Drawing type

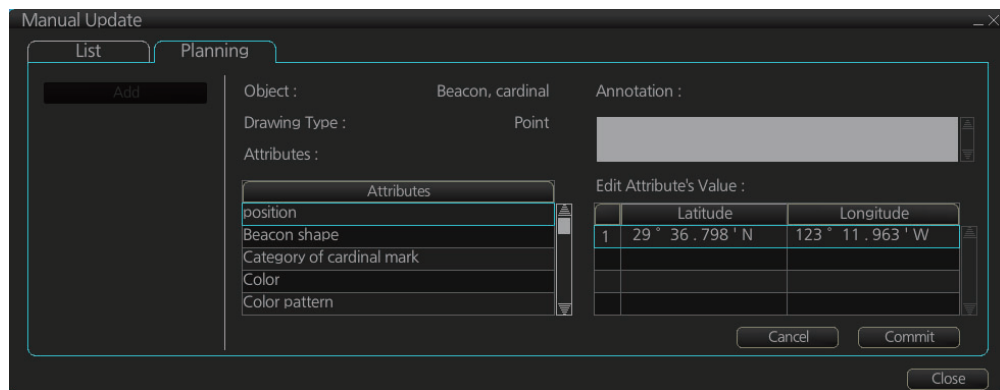
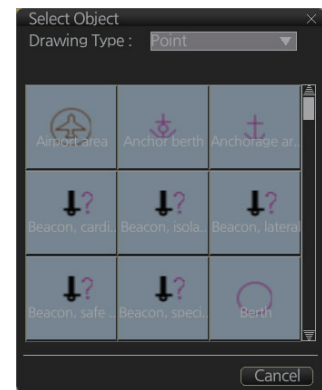

8. You can add a comment related to a manual update object in the [Description] box.

3. HOW TO MANAGE CHARTS

- To add textual information to an attribute, select the attribute from the [Attributes] window then add text in the [Edit Attribute's Value] window.
The [Date end] factory default is set to three months from the date of insertion and applies to all chart items. You can adjust the dates here.
- Click the [Commit] button to add all selected objects to the chart.

Note 1: If there is no textual information entered in the [Annotations] window, a confirmation message appears when you click the [Confirm] button. Check that the information is correct and click [Yes] or [No] as appropriate.

Note 2: A manual update object is displayed until the display until date entered for it has passed. If the object remains on the screen after the display until date, do some operation on the screen to refresh the screen to erase the object.

3.21.2 How to copy objects from an official chart and insert them

You can copy objects from an official chart and insert them as a manual update with the following procedure:

- Right-click the object you wish to copy to show the context-sensitive menu, then click [Manual Update] and [Copy From Chart]. The Copy Chart dialog box appears.

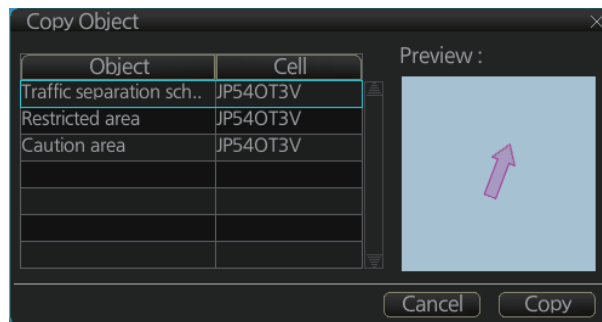

- Click the object to copy, then click [Copy]. The object is copied to the [Manual Update] dialog box.
- Referring to step 8 and step 9 in section 3.21.1, edit the object as required.
- Click the [Commit] button to add the object to the chart.

Note: If there is no textual information entered in the [Annotations] window, a confirmation message appears when you click the [Confirm] button. Check that the information is correct and click [Yes] or [No] as appropriate.

3.21.3 How to ignore chart objects

Manually entered update symbols cannot be deleted until the display until date arrives or is changed. However, you can mark the symbol to indicate that it can be ignored.

- Put the cursor on the symbol then right-click to show the context-sensitive menu.
- Select [Manual Update] and [Delete].

The symbol is marked with a diagonal line.

Deleted symbol is marked with a diagonal line



3.21.4 How to delete (hide) a chart object

You can hide a manually inserted chart object by doing the following:

1. Referring to step 1 and step 2 of section 3.21.1, show the [Manual Update] dialog box.
2. Click the [List] tab.
3. Click the object to hide, then click the [Remove] button. The selected item is hidden from the chart display.

3.21.5 How to modify existing update symbols

The position, Display until date and description of an update symbol can be modified. A symbol that is marked as “deleted” cannot be modified.

1. Follow steps 1-2 in section 3.21.1 to display the [Manual Update] dialog box.
2. Click the [List] tab.

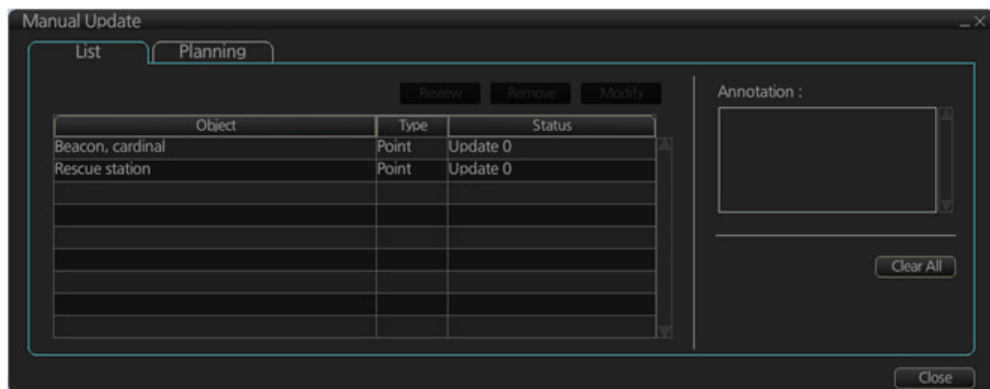

3. Select the object to modify then click the [Modify] button. The [Planning] dialog box appears.
4. Modify the object referring to steps 8 and 9 in section 3.21.1.
5. Click the [Commit] button.

Note: If there is no textual information entered in the [Annotations] window, a confirmation message appears when you click the [Confirm] button. Check that the information is correct and click [Yes] or [No] as appropriate.

3.21.6 How to review a chart object

You can review a chart object in order to see the object before any changes were made. To review an object, do the following:

1. Referring to step 1 and step 2 of section 3.21.1, show the [Manual Update] dialog box.
2. Click the [List] tab.
3. Select the object to review then click the [Review] button.

Manually updated objects appear with a thick line, as shown in the figure to the right.

Objects under review appear in the [Manual Update] dialog box with the status "Review x" (x indicates the state at which you are viewing the reviewed object). The object appears in a pre-modified state, and with each press of the [Review] button, one modification is “reverted”.

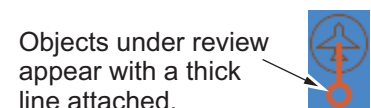

3.21.7 How to remove all manual update data

You can remove all manual update data by doing the following:

1. Do steps 1-2 in section 3.21.1 to display the [Manual Update] dialog box.
2. Click the [List] tab.
3. Click the [Clear All] button.

3.22 How to Synchronize Chart Data

This section shows you how to synchronize chart data between FMD-3xx0, FAR-2xx9 and FCR-2xx9 units, so that all units share the same chart data. Synchronization can be done automatically or manually (see section 3.22.2), however all units selected for synchronization must be powered to complete the synchronization. Synchronization includes the following actions:

- Synchronize public keys
- Synchronize chart permits and licenses
- Synchronize chart data
- Synchronize manual updates

Note 1: Before synchronizing chart data, confirm that all units selected for synchronization are powered. (Do not turn off a unit during synchronizing.) If a unit is turned off during the synchronizing, do the following on the unit which contains the medium:

- Open the [Sync Status] dialog box then click the [Disable Sync] button to disable synchronization. Power all units registered for synchronization, then click the [Urge Sync] button on the [Sync Status] dialog box on the unit containing the media to forcibly synchronize.
- Make a group of all the units currently powered, referring to section 3.22.1, and register the group with [Grouped with This Unit]. Reset the power on all units selected for synchronization.

Note 2: C-MAP charts are not automatically synchronized. C-MAP charts are only synchronized immediately after installing or updating the C-MAP database. If the system has several FMDs, make a group of associated units before you install C-MAP charts.

3.22.1 How to select the units to synchronize

Do as follows to select the units to synchronize.

1. Get into the Chart maintenance mode. On the InstantAccess bar™, click [System] followed by [Sync Config] to show the [Sync Config] dialog box.



[Grouped with This Unit]: This window shows the units currently selected for synchronization.

[Not Synchronize with This Unit]: This window shows the units not selected for synchronization.

2. **To select a unit for synchronization:** Put a checkmark next to the unit's name in the [Not Synchronize with This Unit] window then click the << button. That unit's name is moved to the [Grouped with This Unit] window.
To deselect a unit from synchronization: Put a checkmark next to the unit's name in the [Grouped with This Unit] window then click the >> button. That unit's name is moved to the [Not Synchronize with This Unit] window.
 To deselect all units, click the [Reset All] button.
3. Click the [Save] button to finish.
4. Restart the power on applicable units to apply synchronization configuration changes.

3.22.2 How to check synchronization status

You can check chart synchronization status on the [Sync Status] dialog box. Chart synchronization operations also are available from this dialog box. Normally, chart synchronization is done automatically, according to the sync settings on the [Sync Config] dialog box. Use the [Sync Status] dialog box to manually synchronize chart data when there is network failure, for example.

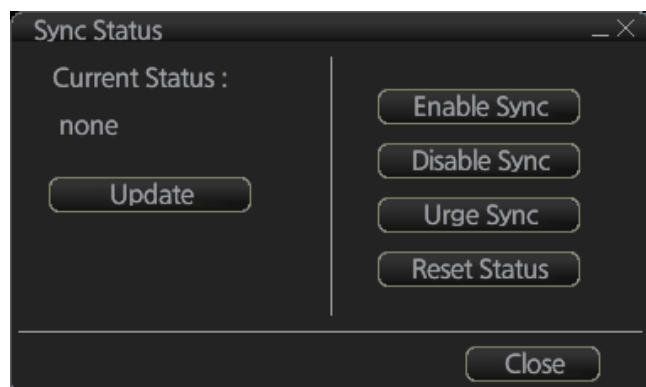

Get into the Chart maintenance mode. On the InstantAccess bar™, click [System] followed by [Sync Status] to show the [Sync Status] dialog box.

[Current Status]: Displays current synchronization status. The table below shows all the synchronization status messages.

Sync status	Meaning
disabled	Synchronization is disabled.
must receive	This ECDIS will receive chart data from another FMD-3xx0, FAR-3xx0, or FCR-2xx9.
must send	This ECDIS will send chart data to another FMD-3xx0, FAR-3xx0, or FCR-2xx9.
none	No synchronization task ready.

Note: Do not update charts manually when the sync status is “must receive”. Data may be corrupted. Wait until syncing is completed before updating charts manually.

[Update] button: Click this button to update [Current Status].

[Enable Sync] button: Enables synchronization. You are asked, "Do you want to enable sync?" Click the [OK] button to enable synchronization. Synchronization is always enabled when ECDIS starts. A progress bar indicates progress in synchronization. The bar is erased within five minutes after completion of synchronization.

[Disable Sync] button: Disables synchronization function temporarily. Use this feature to enable chart administration in case of network failure, for example. You are asked, "Do you want to disable sync?" Click the [OK] button to temporarily disable synchronization.

Note 1: In normal operation do not disable synchronization. If you accidentally disable synchronization, try to synchronize by clicking the [Enable Sync] button. If that does not work, reset the power of all units selected for synchronization then click the [Urge Sync] button to synchronize.

Note 2: With synchronization disabled, the message "Synchronization disabled" may appear twice when installing a license. This does not affect installation of a license.

[Urge Sync] button: Does immediate synchronization. You are asked, "Chart data in other units will be overwritten by this unit. Do you wish to continue?" Click the [OK] button to synchronize. If synchronization is not successful, restart applicable units and try again.

[Reset Status] button: Reset synchronization status to recover from synchronization status conflict. You are asked, "Do you want to reset sync status? This unit may be synchronized from the other unit." Click the [OK] button to reset.

3.22.3 Manual updates and synchronization

If you are synchronizing multiple FMD-3xx0 units (or FAR-3xx0, FCR-2xx9) while manual updating is being done on one of the units, the message “File not found” may appear, meaning the manual update data was deleted. If this occurs, follow the procedure below to synchronize the units mentioned above. The procedure uses ECD001 and ECD002 as an example.

1. At the ECD001, get into the Chart maintenance mode, then click [System] and [Sync Config] on the InstantAccess bar™.
2. Add ECD002 to [Grouped with This Unit] then click the [Save] button.
3. Reset the power on the ECD001 and ECD002.

4. At the ECD001, get into the Chart maintenance mode, then click the [System] and [Sync Status] buttons on InstantAccess bar™ to show the [Sync Status] dialog box.
5. Click the [Urge Sync] button to synchronize charts between ECD001 and ECD002.
6. To confirm synchronization, do as follows:
 - 1) At the ECD001, get into the Voyage navigation mode then click the Manual Update button on the Instant Access bar.
 - 2) Click the [Planning] tab followed by the [Add] button.
 - 3) Insert an object at the ECD001.
 - 4) At the ECD002, move the cursor or change the chart scale. Confirm that the chart is updated.

3.23 How to Reconvert All SENC Charts

If you unintentionally installed outdated SENC charts, you can reconvert those charts to the latest SENC charts. Get into the Chart maintenance mode, click the [System] and [Reconvert] buttons on the InstantAccess bar™ to reconvert all your SENC charts.

Note: All manual updates are removed in the reversion.

3.24 How to Manage Gate-1 Charts

Gate-1 provides the ECDIS with the up-to-date UKHO chart data and permit file. To use Gate-1, the [Chart Service] setting must be set to [FURUNO], in the installation.

3.24.1 How to select the chart type(s) to install

1. Click the [CHARTS] button on the Status bar.
2. Click the [System] button on the InstantAccess bar™, then click [Gate-1 Config.] to show the [Gate-1 Config] window.

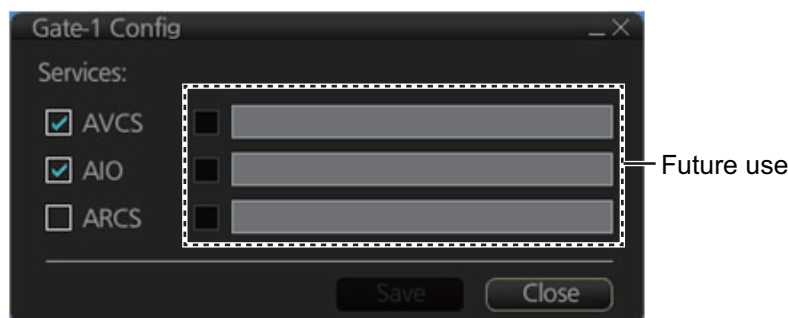

3. Check the chart type(s) that you want to install, then click the [Save] button.
4. You are asked if you are sure to save Gate-1 settings. Click the [OK] button to save settings. The message "Gate-1 services are saved. New services are applied after reboots." appears.
5. Click the [OK] button several times, then restart the unit.

3. HOW TO MANAGE CHARTS

3.24.2 How to install charts and licenses

To install the chart selected at section 3.24.1 and its license, click the [CHARTS] button on the Status bar, then click the [Gate-1] button on the on the InstantAccess bar™. The message "This process takes time to complete, and the operation speed of this system will decline. Do you wish to continue?" appears. Click the [OK] button to continue and install your charts.

3.24.3 How to order licenses

Follow the procedure below to order licenses from Gate-1.

1. Click the [Manage Charts] button to show the [Manage Charts] dialog box.

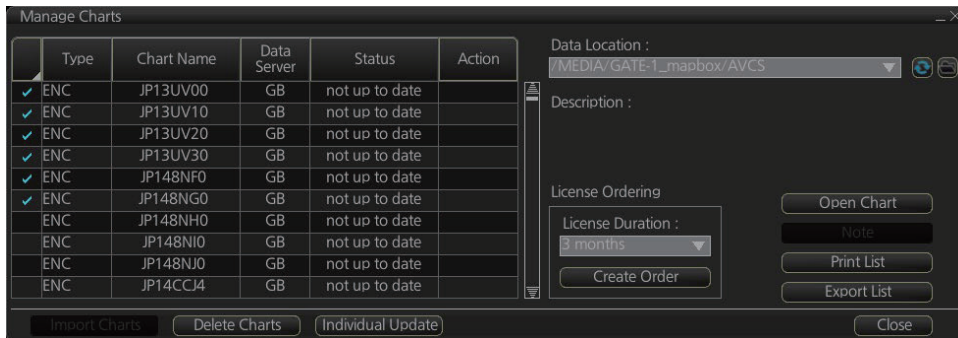

2. At the [License Ordering] window, select the license duration from the pull-down list.
3. Click an appropriate block in the far-left hand column to select the chart to order. Repeat to select other charts.
4. After selecting the chart(s) to order, click the [Create Order] button. A window shows the charts ordered together with total cost.

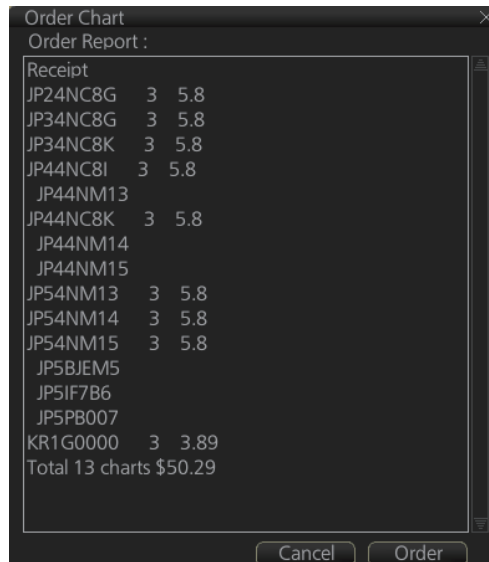

5. Confirm the licenses and cost, then click the [Order] button.

After completing the purchase operation, the chart license purchase procedure is done via Gate-1. It takes several hours for a new license to arrive at Gate-1.

Note 1: Once a purchase is made you cannot cancel the purchase. Take care when making your order.

Note 2: Only UKHO AVCS and AIO licenses can be purchased.

Note 3: A network communication usage fee is assessed when purchasing a license.

Note 4: Unselected cells may appear in the order window because of the AVCS sales format.

Note 5: When navigating a route with the chart filter on, the filter is applied to the region of the cell where a cell has not been purchased. A region does not always have actual data in all ranges.

3.25 How to Delete Chart Data

Converted data (ENC: SENC, ARCS: SRNC), license, and product list data can be deleted collectively as follows:

How to clear all ENC data: Click the [CHARTS] button on the Status bar. On the InstantAccess bar™, click the [System], [Clear Charts] and [ENC] buttons.

How to clear ARCS data: Click the [CHARTS] button on the Status bar. On the InstantAccess bar™, click the [System], [Clear Charts] and [ARCS] buttons.

Note: For how to delete C-MAP data, see section 3.8.

3. HOW TO MANAGE CHARTS

This page is intentionally left blank.

4. HOW TO CONTROL CHART OBJECTS

This chapter provides the information necessary for controlling chart features.

4.1 How to Browse Your Charts

You can view your charts using different positions and different scales. The basic tools for browsing charts are the scrollwheel, chart offcenter, and scroll.

The scrollwheel changes the chart scale. If true motion reset is active, ZOOM IN and ZOOM OUT keep the relative position of your ship with respect to the display. If true motion reset is off, ZOOM IN and ZOOM OUT keep the relative position pointed by the cursor with respect to the display. The system automatically chooses next larger or smaller scale. If a chart with larger compilation scale is available at your current viewing position, the message "Larger Scale ENC Available" appears.

The own ship position can be easily relocated to the screen center in the Navigation voyage and Navigation planning modes. Further, in the Navigation voyage mode, the own ship position can be put at the cursor position.

To move the own ship mark to the screen center, put the cursor in the chart area and right click [Ship on center]. **To move the own ship mark to a location**, right-click the position on the chart where to put the own ship mark then right click. ([Ship off center] is not available in the Voyage planning mode.)

To scroll your chart, simply drag and drop.

4.2 How to Control Visibility of Chart Objects

The [Chart Display] menu has several pages of chart features that you may show or hide as appropriate. To display this menu, click the [DISP], [SET] and [Chart DISP] menu on the InstantAccess bar™.

4.2.1 How to set value for shallow contour, safety depth, safety contour and deep contour

You can set values for Shallow Contour, Safety Depth, Safety Contour and Deep Contour, on the [Chart Alert] dialog box (sequence: [DISP], [SET], [Chart Alert]). Colors used for depth presentation on the electronic chart are controlled by setting values for Shallow Contour, Safety Depth, Safety Contour and Deep Contour. Soundings on the electronic chart, which are equal to or less than the value of Safety Depth, are highlighted. See the illustrations on the next page for multi-color presentation and two-color presentation. Selection of multi- or two-color presentation can be done with [Four Shades] on the [General] page of [Chart Display] menu. Check the check box for multi-color; uncheck the box for two-color.

Note: The shallow contour cannot be set higher than the safety contour.

MULTI-COLOR presentation

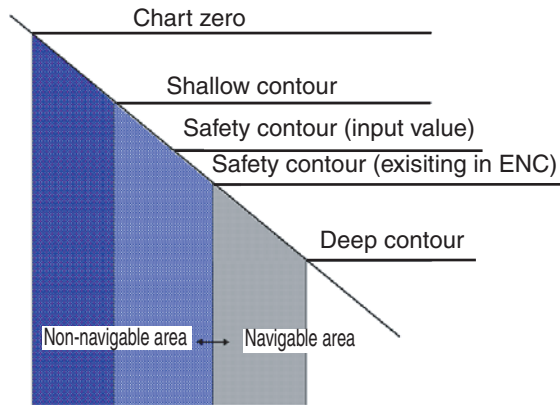

In the multi-color presentation four colors are used for depths. If the value entered as the safety contour does not exist in the electronic chart, the system automatically selects the next available deeper depth contour as the safety contour. For example, the input value is 8 m, but there is no 8 m depth contour in the electronic chart. Then, the system automatically selects the next available deeper depth contour (10 m) as the safety contour. The depth contour value of 10 m is used as the safety contour in the electronic chart.

The shallow contour shows visual color change inside an unsafe water area. An unsafe water area is all areas shallower than the "safety contour". Set the value for the shallow contour less than the value of the safety contour.

TWO-COLOR presentation

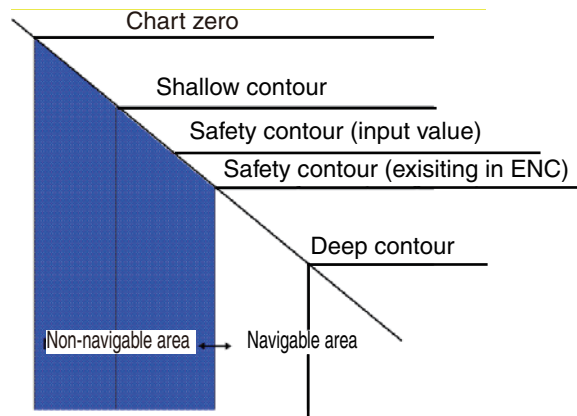

In the two-color presentation, unsafe water is shown in blue and safe water is shown in white. The safety contour is used to qualify unsafe water (depth shallower than safety contour) and safe water (depths deeper than safety contour).

If the value entered as the safety contour does not exist in the electronic chart, the system automatically selects the next deeper available depth contour as the safety contour, the same as with the multi-color presentation.

4.2.2 Basic Setting menu

To display this menu, click [DISP], [SET] and [Basic Setting] on the InstantAccess bar™.

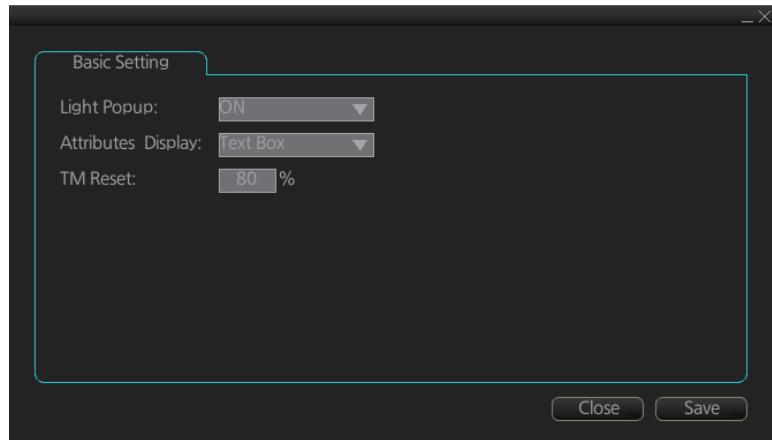

Light Popup: Show or hide light sectors information. [ON] provides light sector information (including length of arc of visibility) when the cursor is put on a light or light sector.

Attributes Display: Select how to show chart object information in the [Pick Report] dialog box, [Text Box] or [List].

List: Show the information in a list, like the one shown below.

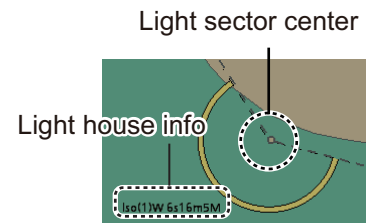

Text Box: Show the information in a text box, like the one shown below.

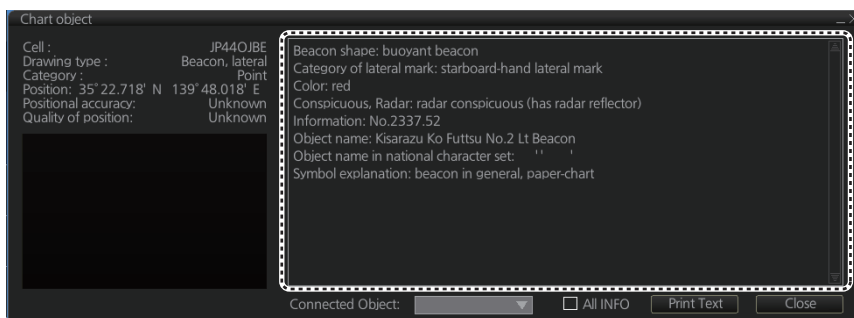

TM Reset: In the true motion mode, own ship moves until it reaches the true motion reset borderline (set here), and then it jumps back to an opposite position on screen based on its course. Set the limit for TM reset (in percentage). For example, “80” resets the position when the own ship marker is at a location which is 80% of the range.

4. HOW TO CONTROL CHART OBJECTS

4.2.3 Chart Display menu

To access the [Chart Display] menu and its pages, click [DISP], [SET] and [Chart?DISP] on the InstantAccess bar™. then select [General], [Standard], [Other], [Text], or [NtoM] page as appropriate.

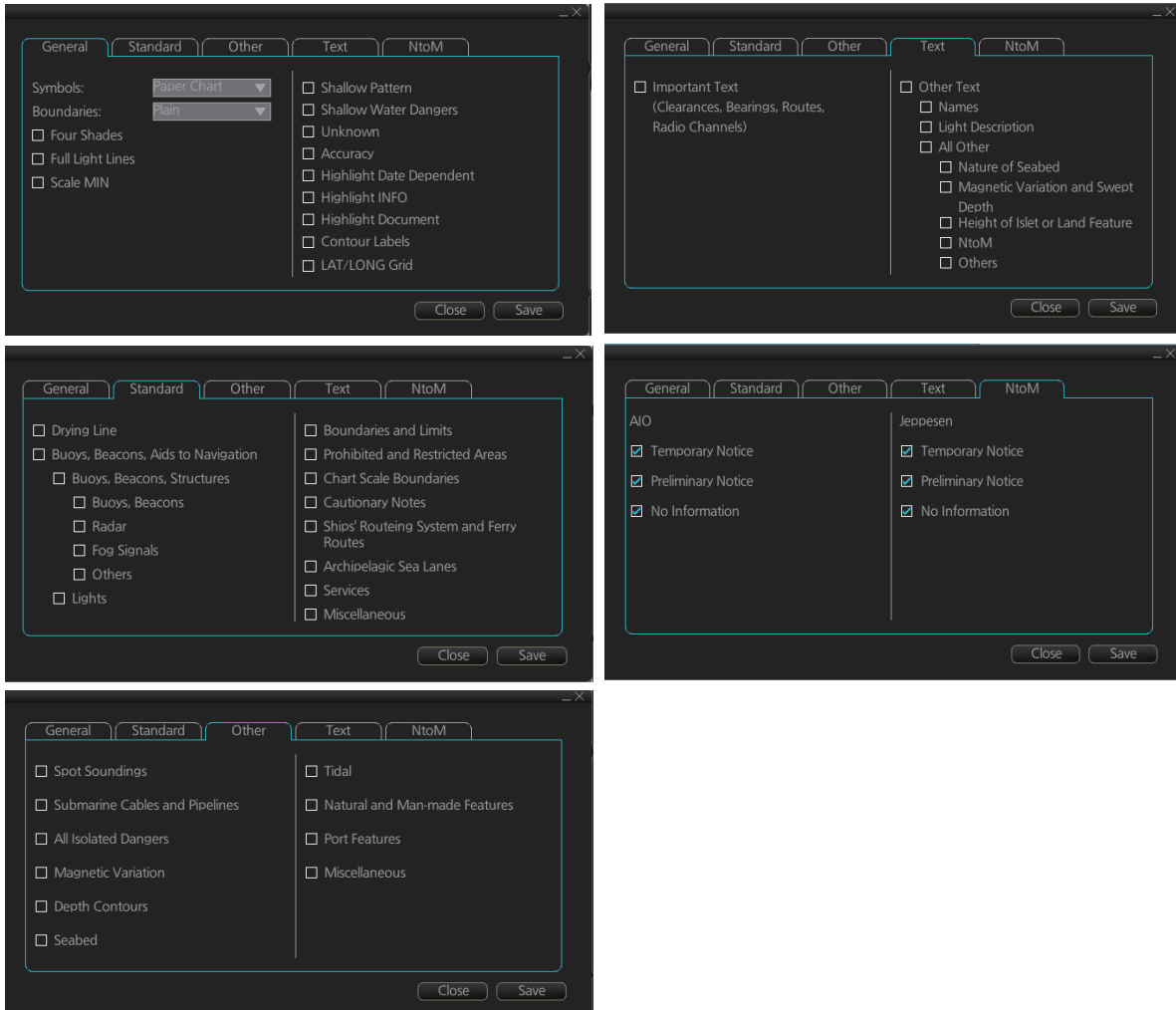

General page

This page turns chart features on (checkbox checked) or off.

Symbol: Determines how to display chart symbols.

- Paper Chart: Symbols displayed the same as the conventional paper chart symbols
- Simplified: Symbols displayed in simplified style, and the sea is displayed in color.

Boundaries: Determines how to show boundary lines of chart objects.

- Plain: Boundary line shown with solid and dashed lines.
- Symbolized: Symbol is attached to the line according to the purpose of the line.

Scale MIN: Set the minimum chart scale to display chart objects. When the chart scale is lower than set here, the chart objects will not be displayed.

Highlight Date Dependent: Put a highlight mark on the chart object which carries a date dependent attribute.

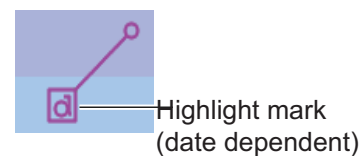

Highlight INFO, Highlight Document: Put a highlight mark on a chart object that has information or document attribute.

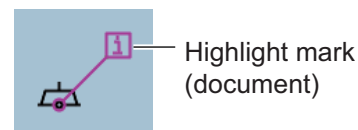

Standard page

The [Standard] page contains chart features defined by IMO that comprise a standard display.

Other page

The [Standard] page contains chart features not contained in IMO standard display.

Text page

Show or hide text information on the chart.

NtoM page

Show or hide the Notice to Mariners data.

Note: To use the “pick report” feature, which provides information for a cursor-chosen chart feature, the associated chart feature must be turned on from the [General], [Standard], [Other], [Text], or [NtoM] page.

4.2.4 Display base

A subset of chart features is called the “display base”. As required by IMO, these features cannot be made invisible. To get the display base, click [STD DISP] on the Status bar.

The display base consists of the following chart features:

- Coastline (high water)
- Own ship's safety contour, which is chosen by the user
- Indication of isolated underwater dangers of depths less than the safety contour that lie within the safe waters defined by the safety contour
- Indication of isolated dangers that lie within the safe water defined by the safety contour such as bridges, overhead wires, etc., and including buoys and beacons whether or not these are being used as aids to navigation.
- Traffic routine systems
- Scale, range, orientation and display mode
- Units of depth and height

4.3 How to Control Visibility of Symbols, Features

Control of symbols and features is divided into five pages in the [Symbol Display] menu, which you can access by clicking the [DISP], [SET] and [Symbol DISP] buttons on the InstantAccess bar™.

[General] page: Controls own ship and target related items.

[Tracking] page: Controls past tracks and some other features.

[Route] page: Controls planned and monitored route.

[Mariner] page: Controls user charts.

[Targets] page: Controls TT and AIS targets.

The user can define settings for chart details that are displayed over the chart area.

4.3.1 General page

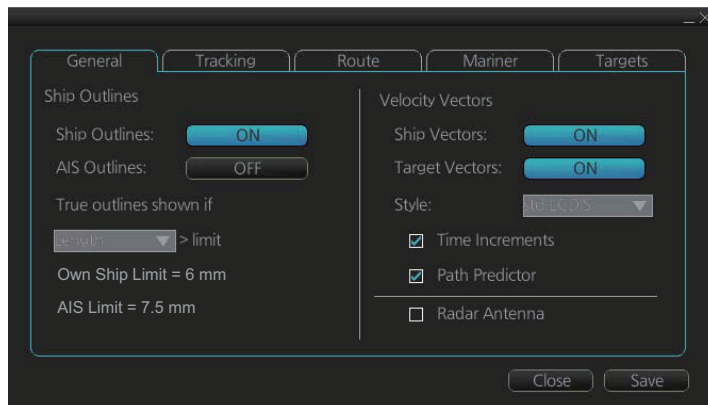

Ship, AIS Outlines

Ship Outlines: Select OFF or ON to show minimized or scaled symbol, respectively.

AIS Outlines: Select OFF or ON to show AIS targets in same size or scaled symbol, respectively.

True outlines shown if: If the length or width of the own ship mark is greater than 3 mm, the own ship mark is shown with the true scale symbol. Select [Length] or [Beam width].

The right illustration in the figure below shows own ship mark and AIS targets with scaled symbols. The left illustrations shows own ship mark and AIS targets with point symbols. AIS targets are displayed as true scale symbol if the displayed chart scale is larger than set with "Outlines" limit (length>3.0 mm) on the [General] page in the [Symbol Display] menu and your own ship are displayed as true symbol scale if the size of the true scale symbol is larger than 3 mm on the chart display.

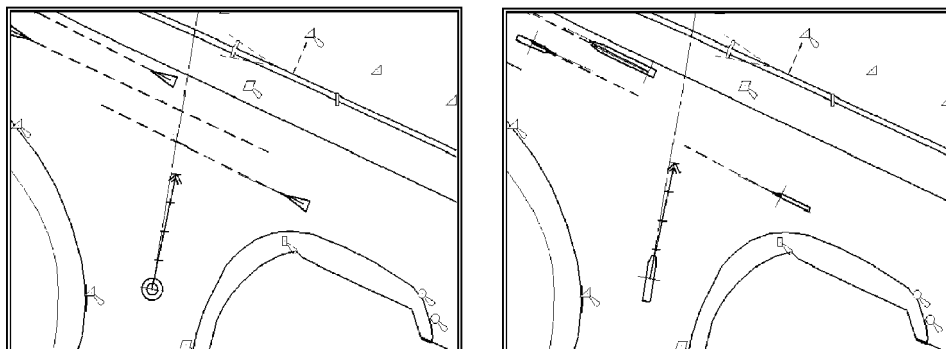

Velocity Vectors

Ship Vectors: Show or hide own ship vector.

Target Vectors: Show or hide target vectors.

Style: Select the vector style. The [std ECDIS] vector is a speed-referenced vector symbol. [Conventional] is a simplified symbol.

Time Increments: Check to show ticks of velocity vector. This controls both own ship and targets ticks. If ticks are too tightly spaced, they will be automatically removed from the display, until spacing between ticks is sufficient to distinguish them separately. This depends on display scale and speed of vessel and target.

Path Predictor: Check to show the path predictor. The path predictor is a single dashed line originating at the CCRP and drawn at a length to represent the distance and path own ship will travel over the ground in the user-selected time interval for own ship speed vector.

Radar Antenna: Check to mark position of radar antenna (with "x").

4.3.2 Tracking page

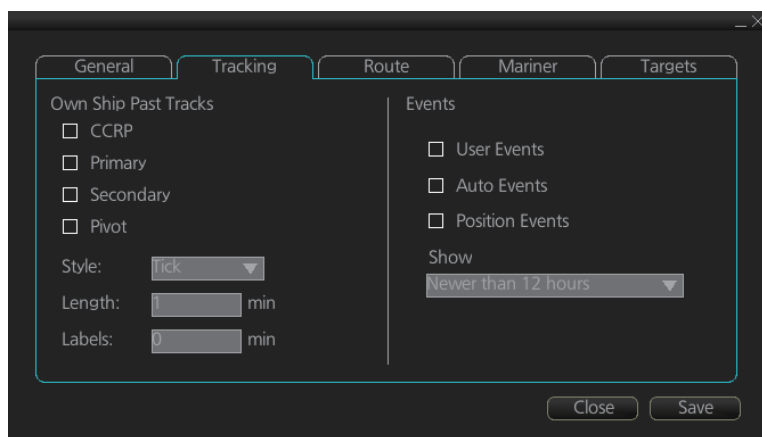

Own ship past tracks

CCRP: Check to plot own ship's track with CCRP position as reference.

Primary: Check to plot own ship's track with position fed from sensor with highest priority.

Secondary: Check to plot own ship's track with position fed from sensor with 2nd highest priority.

Pivot: Check to plot own ship's track with own ship's pivot position as reference.

Style: Select time stamp position for past track (indicated by Tick or Point).

Length: Select length of past track.

Labels: Select label interval.

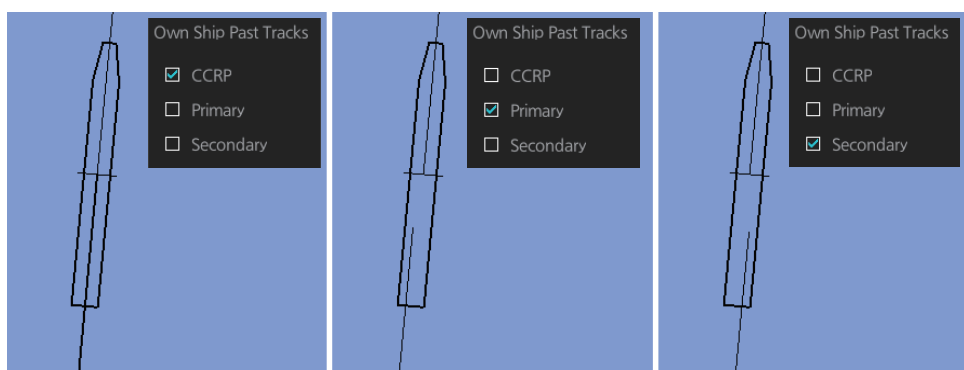

4. HOW TO CONTROL CHART OBJECTS

Events

Events marks are based on the [Voyage] log records.

User Events: Display event symbols on the chart. User events are recorded by clicking [Record], [Event Log] and [User Event] on the InstantAccess bar™.

Auto Events: Display automatically entered event symbols, where the system has recorded an event based on conditions you have set.

Position Events: Display the latitude and longitude of an event, recorded by clicking [Record], [Event Log] and [POSN Event] on the InstantAccess bar™.

Note 1: A MOB event is visible always.

Note 2: You can choose the period of time to display events, from the [Show] list box. [Newer than 12 hours], [Newer than 24 hours], [Newer than 1 week], [Newer than 2 weeks], [Newer than 1 month], [Newer than 3 months], or [All].

4.3.3 Route page

The [Route] page selects the route parts of the monitored and planned routes to show on the ECDIS.

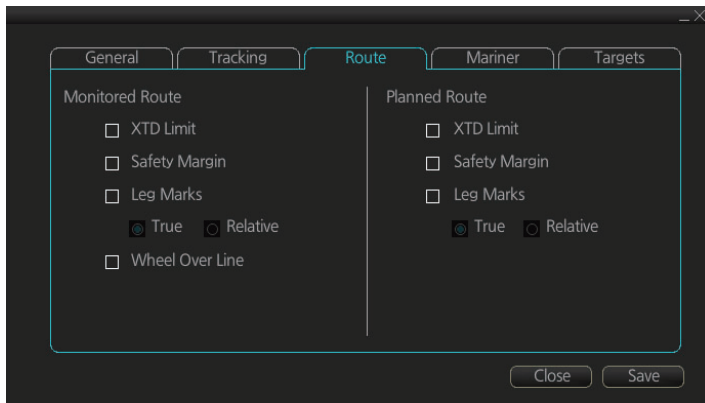

XTD Limit: The distance from the centerline to one side of the nav lane.

Safety Margin: The distance from one side of the channel limit to the safety margin distance.

Leg Marks: Indications of waypoint no. and range and bearing to next waypoint. (**True:** Reference to North; **Relative:** Reference to heading)

Wheel Over Line: The location where the ship turns toward new course. A parallel line appears at the next location.

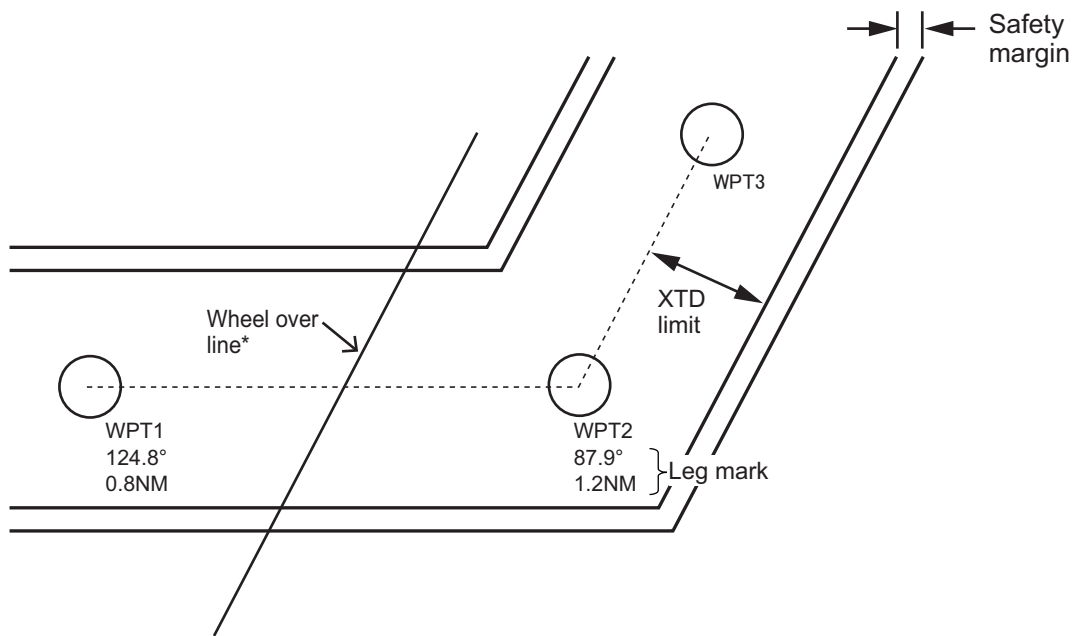

* Wheel over line (WOL)

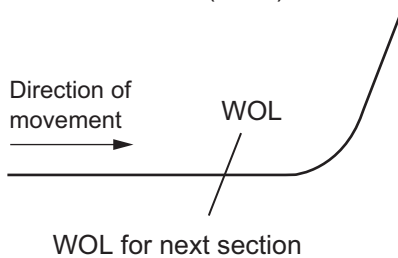

Case 1: Normal

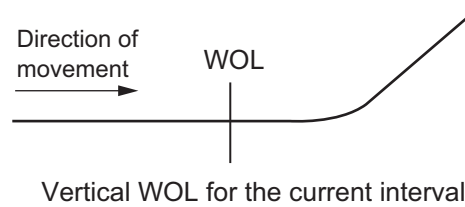

Case 2: Angle for next section is narrow (Not 20 deg)

4.3.4 Mariner page

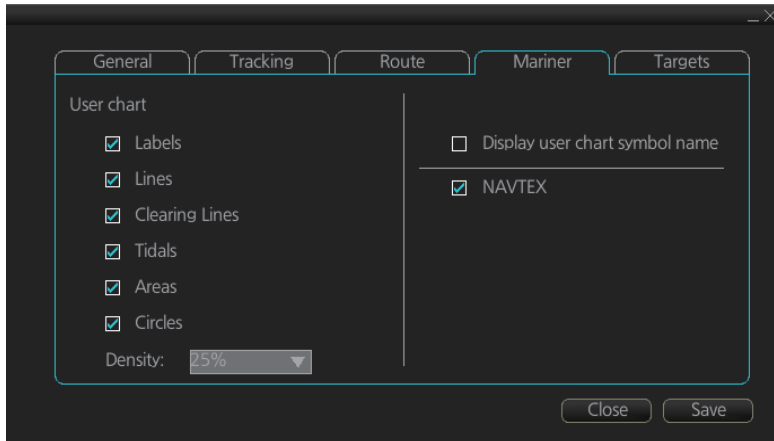

Description

Labels: Check to show labels on user charts.

Lines: Check to show lines on user charts.

Clearing Lines: Check to show clearing lines (for marking dangerous areas) on user charts.

Tidal: Check to show tidal symbols and tidal data on user charts.

Areas: Check to show areas on the user charts.

Circles: Check to show circles on user charts.

Density: Set the degree of transparency for the user chart objects. Color fill for the areas can be chosen as transparent from 0%, 25%, 50% or 75%. Select [0%] to show only boundary lines.

Display user chart symbol name: Check to display on the chart the name entered for a user chart symbol in the [Name] column of the [User Chart] dialog box. Effective for the circle and area symbols only. Names are shown in both the Voyage planning and Voyage navigation modes. See the figure below for examples.

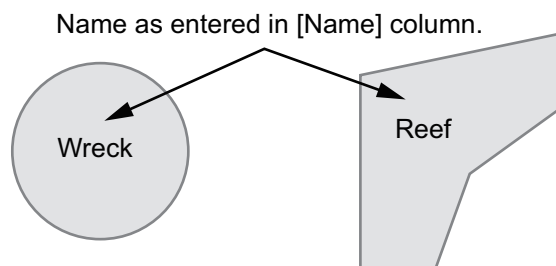

NAVTEX: This item is valid when [Navtex Receiver] is made available in the installation. Check this item to show the MSI mark at the location of the position information contained in a Navtex message. See the illustration at the top of the next page for the information in a Navtex message.

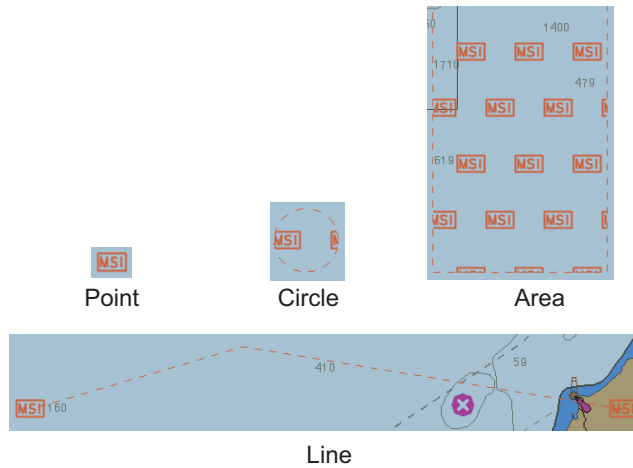

The Navtex page can be opened from the context-sensitive menu. Right-click MSI mark, then select [NAVTEX MSG]. See section 15.2.

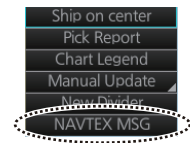

4.3.5 Targets page

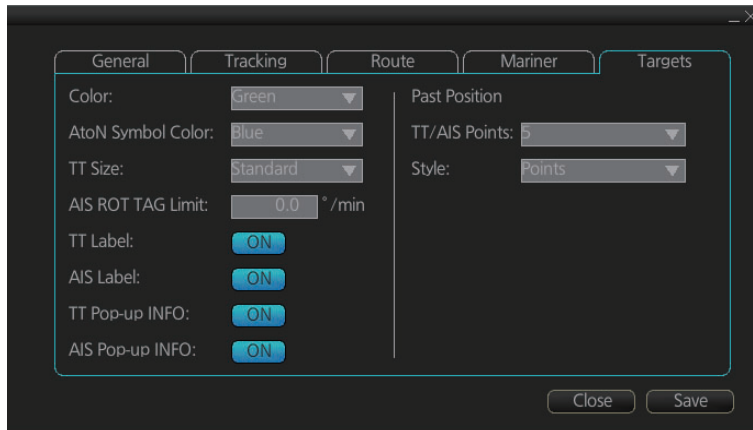

- Color:** Select color of target (TT and AIS, common) from the list box.
- AtoN Symbol Color:** Select color of target (TT and AIS, common) from the list box.
- TT Size:** Select symbol size for tracked targets, Standard or Small.
- AIS ROT TAG Limit:** Show target turning direction.
- TT Label:** Show or hide the TT label (target no.).
- AIS Label:** Show or hide the AIS label (ship's name).
- TT Pop-up INFO:** Show or hide the TT pop-up, which is shown by placing the cursor on a TT.
- AIS Pop-up INFO:** Show or hide the AIS pop-up, which is shown by placing the cursor on an AIS target.



TT pop-up info AIS pop-up info

Note: CPA/TCPA information appears in the AIS pop-up info when the following two requirements are met. If the requirements are not met, CPA/TCPA appears as “**”.

- AIS target is activated at the connected radar
- The TTD sentence for the selected target is received from the connected radar

Past position

TT/AIS Points: Select the number of TT past position points to display.

Style: Select style of presentation of target's past position.

4.4 How to Control Predefined IMO Chart Display Settings

There are three sets of predefined chart display settings that can be used to display charts with certain chart features. The predefined chart display settings are

- IMO BASE
- IMO STD(STANDARD)
- IMO ALL

When the chart settings are changed, the following settings changes are also applied to each page of the [Chart Display] menu.

	[Chart Display] menu		
	IMO Base	IMO Standard	IMO All
[General] page	All items are un-checked.	All items are un-checked.	All items are un-checked.
[Standard] page	All items are un-checked.	All items are checked.	All items are checked.
[Other] page	All items are un-checked.	All items are un-checked.	All items are checked.
[Text] page	All items are un-checked.	All items are un-checked.	All items are un-checked.
[NtoM] page	All items are checked.	All items are checked.	All items are checked.

You can change the chart display setting in use with the [Chart database] button on the Status bar.

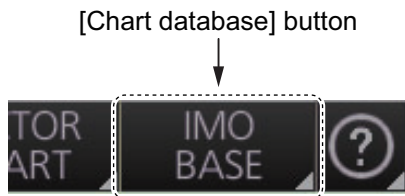

5. VECTOR (S57) CHARTS

Theoretically a chart can be coded for use on a computer as a vector chart. Vector-coded charts are coded using a variety of techniques. One technique is called S57ed3 and it has been chosen by IMO as the only alternative for SOLAS compliant electronic charts. If an S57ed3-coded chart is published by a government-authorized Hydrographic Office, then it is called "ENC". You can read more about ENC and related legal issues in this chapter. Hereafter, all references to vector chart material are referred to as "S57 charts" regardless of their source.

Sometimes you may wish to manually add Notices to Mariners or Navtex warnings into your S57 charts. This is called "manual updates". Also, manual updates are valid for all scales so that you don't need to repeat them for charts published in different scales from the same area.

5.1 Introduction to S57 Charts

An ENC chart is encrypted to prevent unauthorized use so the user needs a permit to view the ENC. This permit can be entered manually with the software, or loaded from a USB flash memory.

Any new ENC must be loaded into the system. Some parts of the charts may be date dependent, i.e., they are visible after a set date or they are visible only for a limited period, etc. For all date-dependent objects set the Display Date and Update Review dates, referring to section 5.2.2. In the paper chart world, the Preliminary and Temporary Notices to Mariners represent the date dependency described above for S57 charts.

An important part of ENCs are the updates. Hydrographic Offices can issue two kinds of updates:

1. Incremental updates, which are small additions to original base cells.
2. Reissues and new editions, which are complete replacements of previous base cells and their updates.

All updates are date stamped and they may also contain date-dependent parts. You can set a date period and create an update report for that period (see section 5.4).

Chart material is stored in media such as DVD ROM, CD ROMs and USB flash memory or electronically through from LAN (Local Area Network) in which it could have arrived in DVD ROMs, CD ROMs or USB memories. Such material can contain only basic cells, cells and updates or only updates. The electronic chart system contains as standard the software required to access a medium.

Each S57 chart may contain additional links to textual descriptions or pictures, besides the chart itself. Typically additional textual descriptions and pictures contain important sailing directions, tidal tables and other traditional paper chart features that do not have any other method to be included into the S57 chart. This system copies these textual descriptions and pictures into its SSD so the user may cursor-pick them for viewing purposes.

5.1.1 Definitions of terms

Cell	A cell is a geographical area containing ENC data and it is the smallest division of ENC data. Each cell has a separate unique name. Hydrographic Offices divide their responsibility area by the cells that they publish.
S57 chart	A database, standardized as to content, structure and format, is issued for use with this system without any authority of government-authorized Hydrographic Office.
ENC	A database, standardized as to content, structure and format, is issued for use with this system on the authority of government-authorized Hydrographic Offices. The ENC contains all the chart information necessary for safe navigation and may contain supplementary information in addition to that contained in the paper chart (e.g., sailing directions) that may be considered necessary for safe navigation. The name of the coding standard for ENC is S57ed3.
SENC	A database resulting from the transformation of the ENC by the system for appropriate use, updates to the ENC by appropriate means, and other data added by the mariner. It is this database that is actually accessed by the system for display and other navigational functions. The SENC may also contain information from other sources.

5.1.2 Chart legend for S57 charts

The [Chart Legend] dialog box provides various information about the ENC chart currently displayed. The information can be displayed two ways:

- **Chart data for own ship position:** Right click the chart area, select [Ship on center] from the context menu, then click [Chart INFO] and [Chart Legend] on the Instant-Access bar™.
- **Chart data for cursor position:** Right click the chart area, select [Ship off center] from the context menu, then click [Chart INFO] and [Chart Legend] on the Instant-Access bar™.

To close the dialog box, click the [Close] button.

This system is capable of showing more than one S57 chart at a time. This feature is called the multi-chart display. If one S57 chart does not cover the whole display, the system will open more S57 chart cells for display, if appropriate cells for the displayed area are available. The chart legend shows information about S57 charts displayed on the electronic chart display area.

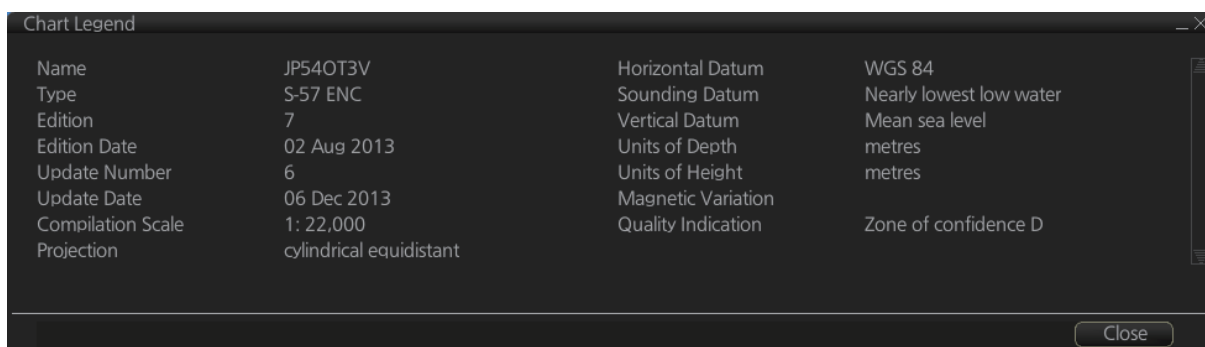

Name: Name of chart.

Type: Type of chart.

Edition: Edition number of the chart.

Edition Date: Date the edition was published.

Update Number: Update number

Update Date: Date of update

Compilation Scale: The scale of the original paper chart is shown here.

Projection: Projection of current chart.

Horizontal Datum: Horizontal datum used with current chart.

Sounding Datum: Datum used to create sounding data.

Vertical Datum: Vertical datum used with current chart.

Units of Depth: Unit of depth used with current chart.

Units of Height: Unit of measurement used to measure height of objects above sea level.

Magnetic Variation: Amount of magnetic variation. A positive value indicates a change in an easterly direction and a negative value indicates a change in a westerly direction.

Quality Indication: Quantitative estimate of the accuracy of chart features, given by the chart producer.

5.1.3 Permanent warnings for S57 charts

Permanent warnings help you keep the S57 charts up-to-date and these are shown at the bottom of the screen. Permanent warnings appear if the system detects a condition that may cause a chart to be not up-to-date.

Message	Meaning, Remedy
Display date is not current	Display date is not the current date. Set Display date and Approved until date to the current date.
No connection to dongle	The dongle is not inserted or not recognized. Insert the dongle to erase the message.
Not up to date (SSE 27): XXXXXXXX (Chart name appears at location of Xs.)	At least one chart is not up to date. Load updated material.
Permit expired (SSE 25): XXXXXXXX (Chart name appears at location of Xs.)	You have an expired permit for a chart. Remove the chart or renew subscription for the permit.

Note: The system can assist in keeping RENC-received charts up-to-date. For charts that have been loaded from sources other than an RENC, the system is unable to know the exact up-to-date situation.

5.2 Chart Viewing Dates and Seasonal Features of the S57 Chart

5.2.1 Introduction

S57 charts contain date-dependent features. Updating in general, including reissues, new editions and updates, creates date dependency. In addition to the obvious date dependency, some features of the S57 charts create additional date dependency. These features include "Date Start", "Date End", "Seasonal date start" and "Seasonal date end". Hydrographic Offices use these features to publish Temporary and Preliminary Notices to Mariners, as their paper chart equivalent updates are called. "Seasonal date start" and "Seasonal date end" are used for seasonal chart features such as summer-only sea marks, seasonal yacht race areas, etc.

You can efficiently use chart viewing date dependency in order to use the valid data for any given date applicable for your navigation or planning purposes. For example, you can check for existence of changes and restrictions weeks before they became valid. Date dependency is a part of the new electronic method to keep your chart up-to-date and valid for your intended use. For voyages longer than one week, you should set Display Date and Update Review at least once during the voyage, to keep your chart up-to-date.

5.2.2 How to set Display Date and Update Review dates

1. On the InstantAccess bar™, click the [Chart INFO] and [Viewing Dates] button. The [Viewing Date] dialog box appears.

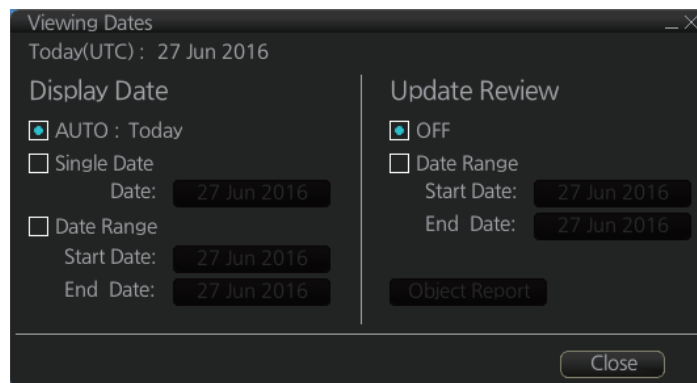

2. Select either [Single Date] or [Date Range] from the [Display Date] column, as appropriate. The date button becomes active and selectable, as shown in the example figure below.

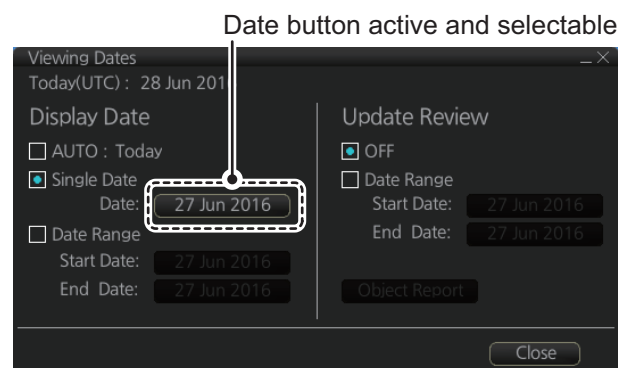

- [Single Date]: Display only charts which have this date.
- [Date Range]: Display all charts within the set range.

3. Click the date button to show the [Set date] dialog box.
4. Select the appropriate date from the calendar, then click [OK] to close the [Set date] dialog box and return to the [Viewing Dates] dialog box.
5. Click [Close].
6. Check the appropriate charts, then access the Viewing Dates dialog again (see step 1).
7. Select [AUTO - Today] to show the current date's chart.
8. Click [Close].

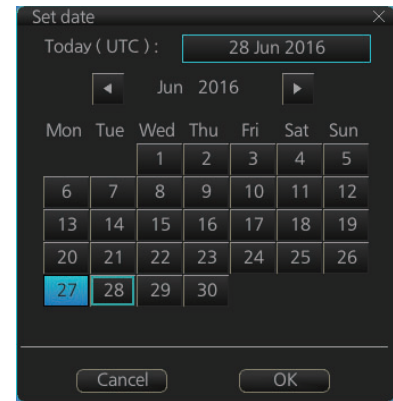

5.2.3 About chart viewing date dependency of S57 standard

How the issue date of updates changes the visibility of the changes

Study the example below to understand the behavior of updates relative to date.

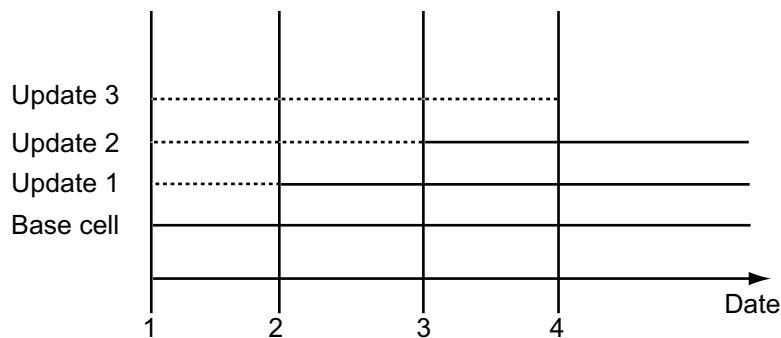

The figure above shows how updates are dependent Chart viewing dates set in Display/Approved date settings by user. Actions 1 to 4 areas as follows:

1. Base cell including three updates is converted into SENC. Display date is set as current date of the system. Approve date has to be set to current date.
2. The date in which update 1 was issued. Display and Approved dates have to be set to correct date in order to see the chart with update 1.
3. The date in which update 2 was issued. Display and Approved dates have to be set to correct date in order to see the chart with update 1 and update 2.
4. The date in which update 3 was issued. Display and Approve dates have to be set to correct date in order to see the chart with update 1, update 2 and update 3.

Note 1: In order to display charts with correct updated situation, always use current date during your voyage. If your voyage lasts more than one week, set current date at least once per week during your voyage.

Note 2: In order to display charts with correct updated situation during route planning, always use planned date of each waypoint to check your plan.

5.2.4 How to highlight updated data

You can highlight updated data by setting a date (or date period) and creating a report.

1. On the InstantAccess bar™, click the [Chart INFO] and [Viewing Dates] button. The [Viewing Date] dialog box appears.
2. In the [Update Review] column, check the [Date Range] box. The [Start Date] and [End Date] buttons become active and selectable.

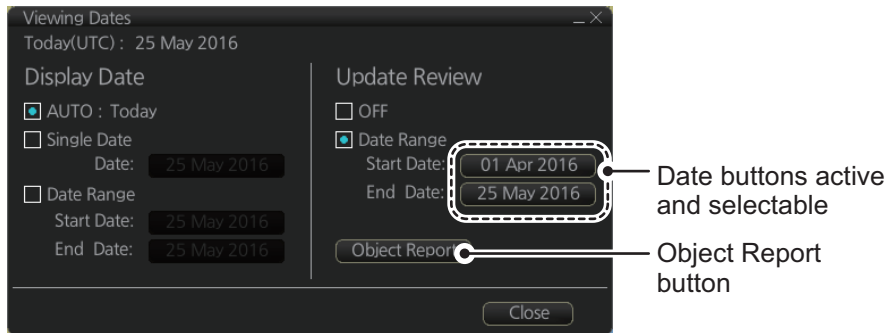

3. Click the [Start Date] button to show the [Set date] dialog box.
4. Select the start date, then click [OK].
5. Click the [End Date] button to show the [Set date] dialog box.
6. Select the end date, then click [OK].
7. Click [Object Report]. The [Object Update Review] dialog appears.

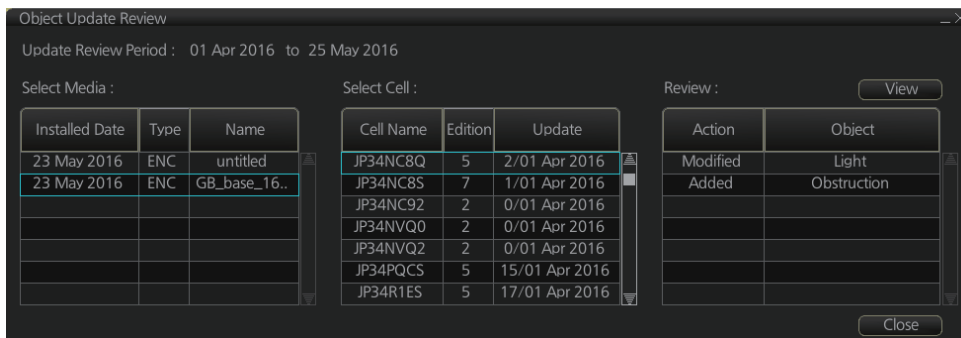

8. Select the items to highlight, then click the [View] button. Items selected here appear with an orange highlight mark.
9. To remove highlights, set the [Update Review] column of the [Viewing Dates] dialog box to [OFF].
10. Click the [Close] button on the [Viewing Dates] dialog box to close the dialog boxes.

5.3 Symbology Used in S57 Charts

You can familiarize yourself with the symbology used by browsing IHO Chart 1, which is included in this system. Note that it behaves as any S57 chart and it follows your selections. See section 4.2.

1. Click the [Chart INFO] and [Chart 1] buttons on the InstantAccess bar™ to show to the [ECDIS Chart 1] menu, shown below.
2. Click a chart feature to show detailed information about the feature. Click [Overview] to show a compilation of all features, shown below.

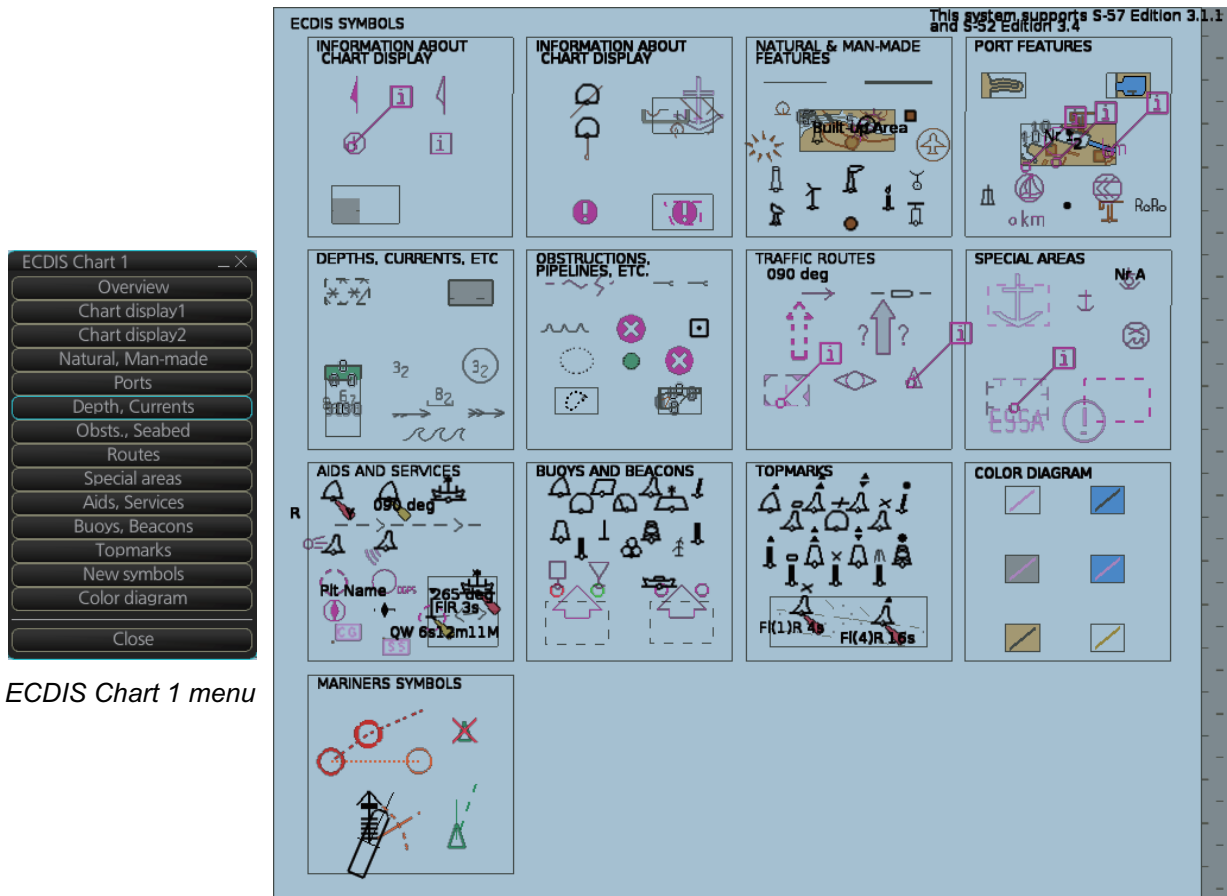

ECDIS Chart 1 menu

5.3.1 Presentation library used for S57 chart features

The system uses the official IHO presentation library to draw S57 charts.

When this manual was published the official presentation library was "pslb04_0.dai", known as "Official IHO presentation library for system Ed 4.0, Edition: 3.4".

5.4 How to Find Information for S57 Chart Objects

The ability to cursor-pick an object to find additional information about the object is an important function of the system. However, an unprocessed cursor pick, which does not discriminate or interpret and merely dumps on the interface panel all the information available at that point on the display, will normally result in pages of unsorted and barely intelligible attribute information.

1. Get into the Voyage navigation mode or Voyage planning mode then right click an object to show the context-sensitive menu. (The menu shown below appears in the Voyage navigation mode.)

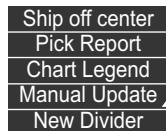

2. Click [Pick Report] to show the [Select Object] dialog box.

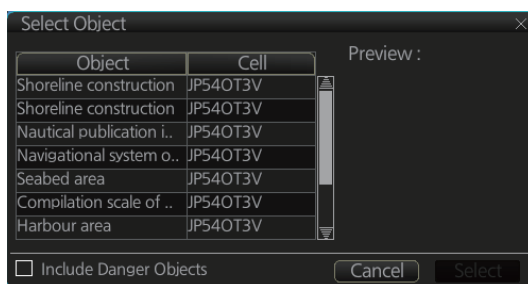

Note: The [Include Danger Objects] check box appears when there is at least one dangerous object. To show dangerous objects in the [Select Object] dialog box, check this box (after the box is checked it becomes unselectable).

3. Click the object for which you want to know its details then click the [Select] button.

Note: Objects selected from the Select Object dialog box are highlighted in orange color and are shown with a broken box (☒).

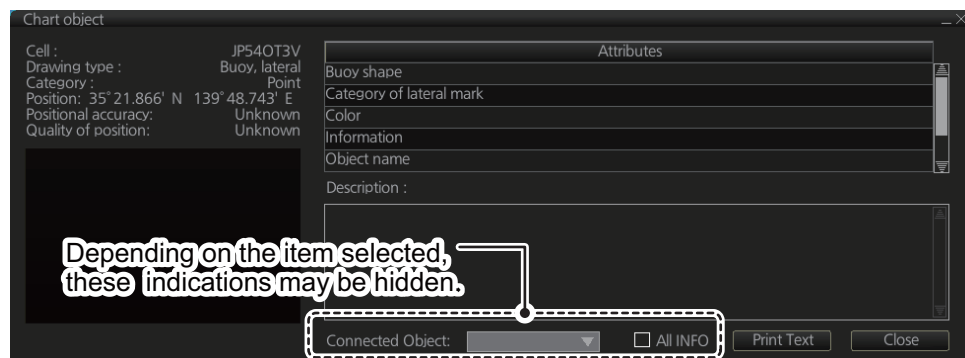

- [Description] window: Click an attribute to view its description in this box.
- [All INFO]: Check the [All INFO] box to show all information in the [Attributes] window. (The [All INFO] box becomes unselectable when checked.)
- [Connected Object]: Objects which are connected to the selected object are shown in the drop-down list. Select an object from the list to show its details.

Note 1: If another window is active, the preview window may be partially obscured by that window. Move the window to display the entire preview.

Note 2: The [Attributes] window of the [Chart Object] dialog box changes according to the settings for [Attribute Display] in the [Basic Settings] menu.

5.5 Admiralty Information Overlay (AIO)

The Admiralty Information Overlay includes all Admiralty Temporary and Preliminary Notices to Mariners (T&P NMs) and provides additional navigationally significant information from UKHO's ENC validation programme. The AIO is displayed as a single layer on top of the basic ENC and is available free of charge as part of the Admiralty S57 Chart Service and within Admiralty Value Added Resellers' services.

The AIO has been developed to ensure mariners can simply view the information they need - in addition to the standard chart - to navigate safely and compliantly. By clearly showing where important Temporary or Preliminary changes may impact a voyage, the Admiralty Information Overlay will give seafarers the same consistent picture of the maritime environment on their charts as they have always had.

The AIO license is free of charge for AVCS license holders.

5.5.1 Installation

Installation is the same as that for the ENC chart. See section 3.3.

5.5.2 How to display the AIO

On the InstantAccess bar™, click the [DISP], [NtoM] and [ALL] buttons to show the AIO. To hide the AIO, click the [DISP], [NtoM] and [OFF] buttons.

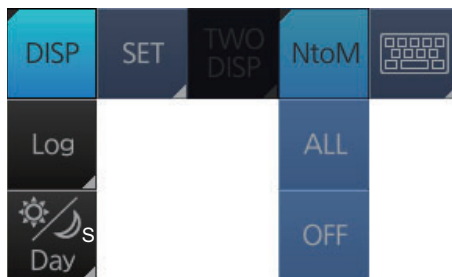

The area(s) that contain temporary or preliminary changes are marked with a hatched red rectangle.

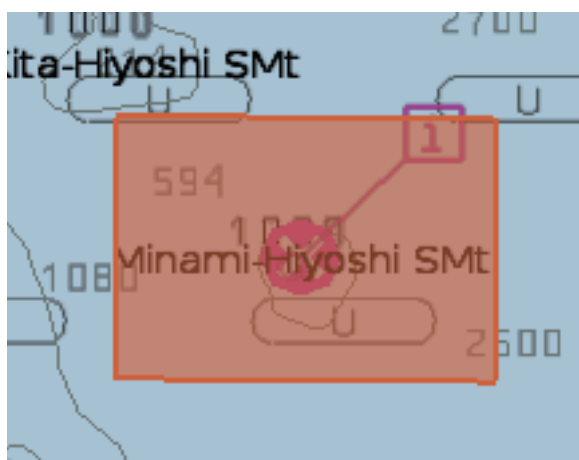

5. VECTOR (S57) CHARTS

5.5.3 Catalog of AIO cells

A catalog of AIO cells is maintained in the [Manage Charts] dialog box. To show this box, get into the Chart maintenance mode then click the [Manage Charts] button on the InstantAccess bar™. The AIO cell is GB800001.

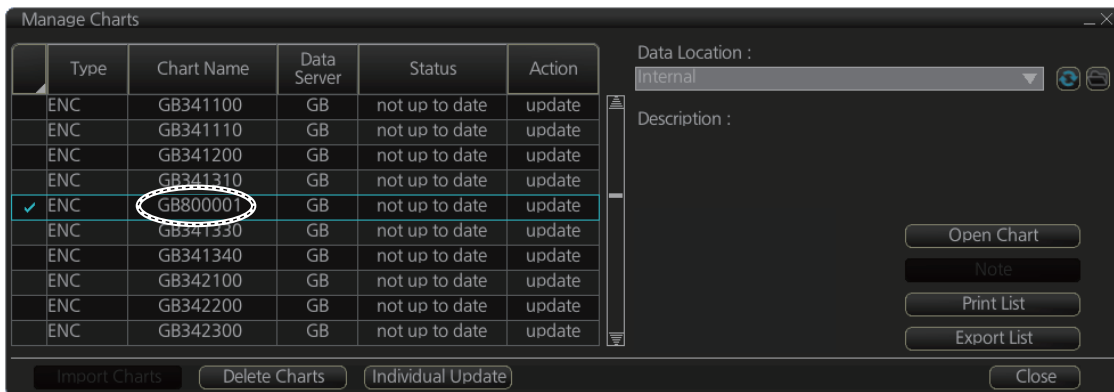

5.5.4 How to find AIO chart object information

Do the following to find chart object information contained in the AIO.

1. Right click a red hatched area in the chart area, then select [Pick Report] to show the [Select Object] dialog box.

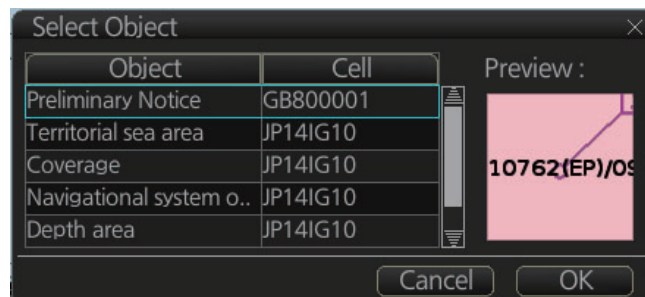

2. Click [Preliminary Notice] in the dialog box to show the [Chart object] dialog box.

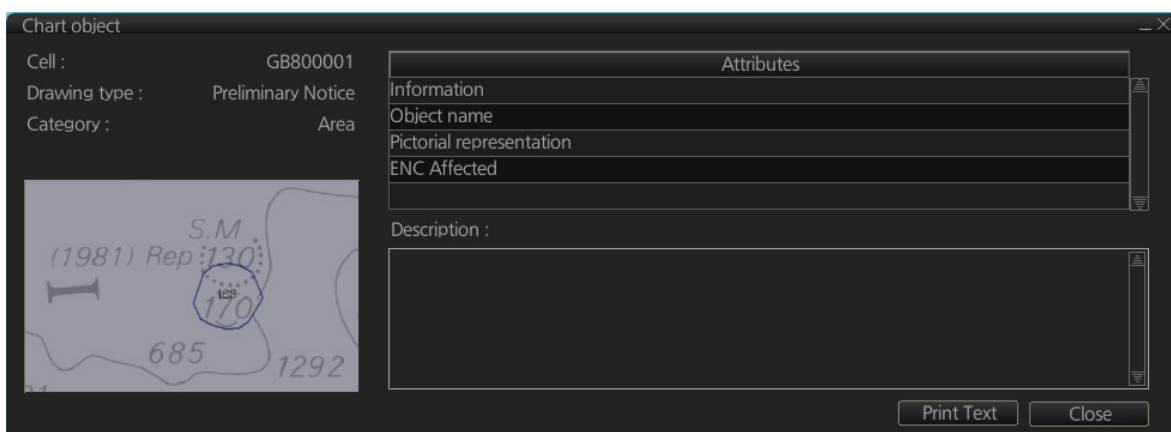

The [Chart object] dialog box shows the following information:

- Cell (name)
- Drawing type (Preliminary Notice, Temporary Notice)
- Category (AIO)
- Positional accuracy

- Quality of position
- The preview box provides a scaled-down image of the area selected. Click the image to enlarge it.
- The [Attribute] window shows the attributes for the AIO area selected. To find information about an attribute, click it to show its information in the [Description] box.
 - Information:** Description of area (for example, danger area).
 - Object name:** Object name (number)
 - Textual description:** Full text of the Notice to Mariners (NtoM)
 - ENC affected:** ENC affected by the NtoM
 - Included in updates:** Date this item was updated ([Preliminary Notice] items only)
- [All INFO] checkbox: Check the box to show [Source indication] at the bottom of the [Attribute] window. (The [All INFO] box becomes unselectable when checked.)

Note: The [Attributes] window of the [Chart Object] dialog box changes according to the settings for [Attributes Display] in the [Basic Settings] menu.

5.5.5 How to select the information to display

Select what type of notices to display as follows:

1. Click the [DISP], [SET] and [Chart DISP] buttons on the InstantAccess bar™.
2. Click the [NtoM] tab.

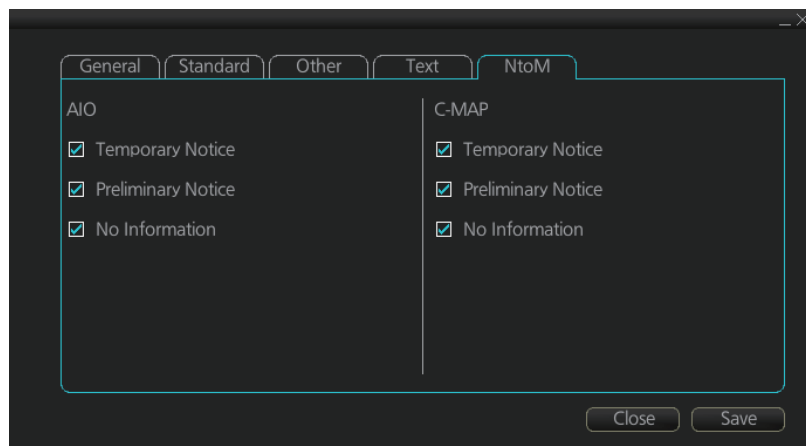

3. In the [AIO] window, check the items to display.
4. Click the [Save] button to save settings then click the [Close] button to close the menu.

5. VECTOR (S57) CHARTS

This page is intentionally left blank.

6. RASTER (ARCS) CHARTS

6.1 ARCS Charts

Approximately 2,700 ARCS charts are available on 11 chart CD-ROMs, covering the world's major trading routes and ports. Regionally based chart CD-ROMs RC1 to RC10 contain standard BA navigation charts, while RC11 contains ocean charts at scales of 1:3,500,000 and smaller. ARCS charts are facsimile copies of BA paper charts, and as such share a common numbering system. New editions and new charts for ARCS and BA paper charts are issued simultaneously. They are supplied on each Weekly Update CD-ROM until incorporated into the chart CD-ROMs at the next issue.

Occasionally, it is necessary to issue new charts in advance of their intended date of validity, for example a change in regulations commencing on a future date. In such cases the current chart will co-exist with the new chart until the date of implementation, the earlier chart having the suffix "X" after the chart number. The system will allow access to both charts for the period of overlap by issue of new chart permits.

Sometimes you may wish to manually add Notices to Mariners or Navtex warnings into your ARCS charts. In this system this is called Manual Updates. Manual updates are valid for both ARCS and S57 charts so that you need to define them only once. Further, manual updates are valid for all scales so that you don't need to repeat them for charts published in different scales from the same area.

6.1.1 Chart legend of ARCS chart

The [Chart Legend] dialog box provides various information about the ARCS chart currently displayed. The information can be displayed two ways:

- **Chart data for own ship position:** Right click the chart area, select [Ship on center] from the context menu, then click [Chart INFO] and [Chart Legend] on the Instant-Access bar™.
- **Chart data for cursor position:** Right click the chart area, select [Ship off center] from the context menu, then click [Chart INFO] and [Chart Legend] on the Instant-Access bar™.

To close the dialog box, click the [Close] button.

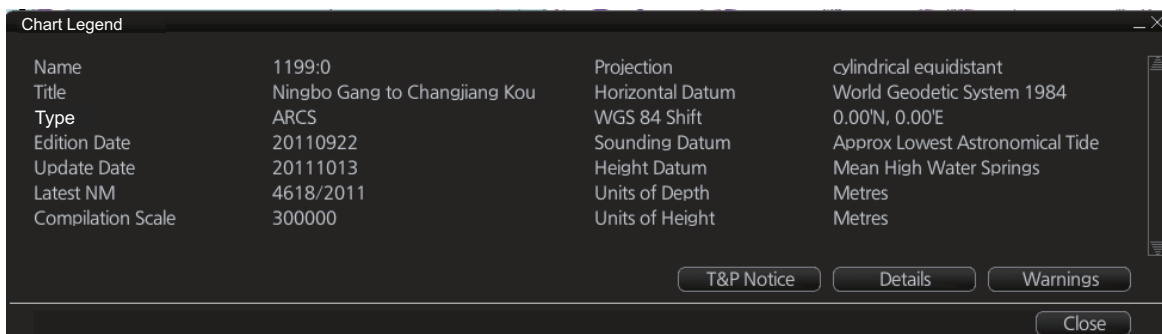

Name: Name of the chart.

Title: Title of the chart.

Type: Type of chart.

6. RASTER (ARCS) CHARTS

Edition Date: Date when the chart was issued.

Update Date: Issue date of Update CD-ROM used to update the system

Latest NM: Date of the latest Notice to Mariners included in the chart.

Compilation Scale: The scale of the original paper chart is shown here.

Projection: Projection of current chart.

Horizontal Datum: Horizontal datum used with current chart.

WGS 84 Shift: Datum shift between local datum and WGS-84 datum is known (=Defined), unknown, operator defined (=Undefined) or shift is known only some parts of chart (=Partially defined).

Sounding Datum: Datum used to create sounding data.

Height Datum: Vertical datum for objects located above sea.

Units of Depth: Unit of depth used with current chart.

Units of Height: Unit of measurement used to measure height of objects above sea level.

[T&P Notice], [Details] and [Warnings] buttons: See the descriptions below.

T&P notice

T&P Notices are also known as Temporary and Preliminary Notices to Mariners and they provide chart information that does not warrant permanent chart correction. To show the T&P Notices, click the [T&P Notice] button on the [Chart Legend] dialog box.

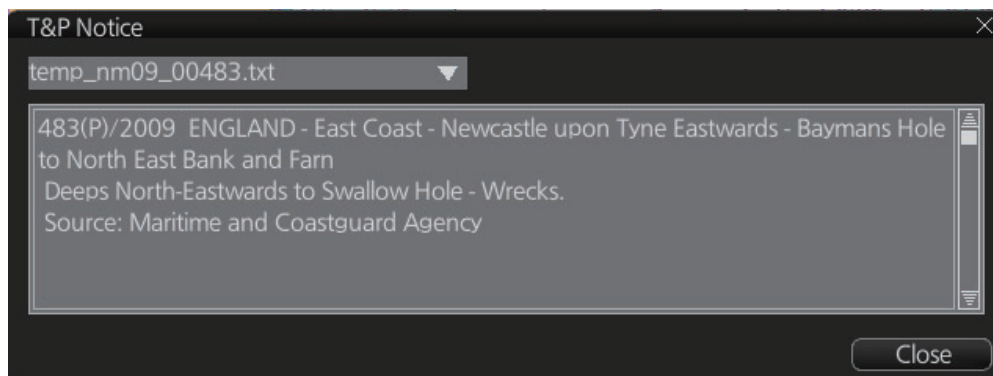

Details

Click the [Details] button on the [Chart Legend] dialog box to show detailed information about current chart.

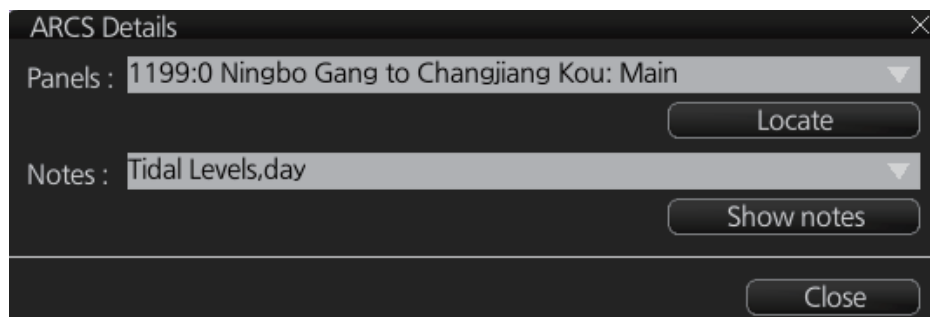

Panels: Selects desired inset (Panel) from the combo box. This works in conjunction with [Notes].

Notes: Select desired Notes from drop-down list then click the [Show Notes] button to display the Notes.

Warnings

There could be warnings not included in Notices to Mariners. British Admiralty may release textual warnings for any chart and they are available here. Click the [Warnings] button to display the [Warnings] window.

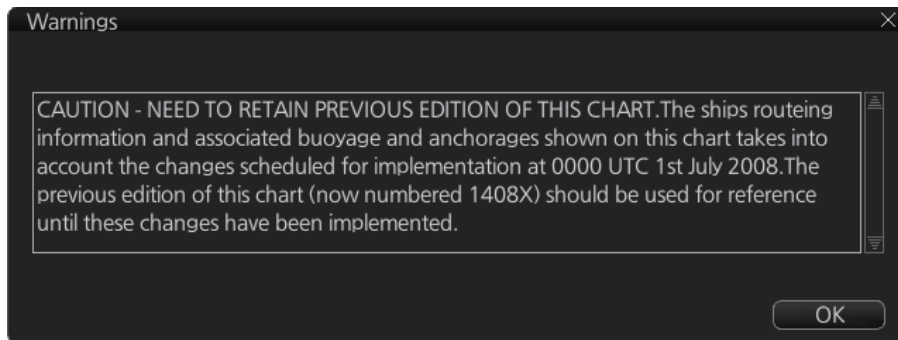

How to set preference for inset (panel)

If there are the different insets with the same position, the operator can select preferred inset, which displays your ship's position.

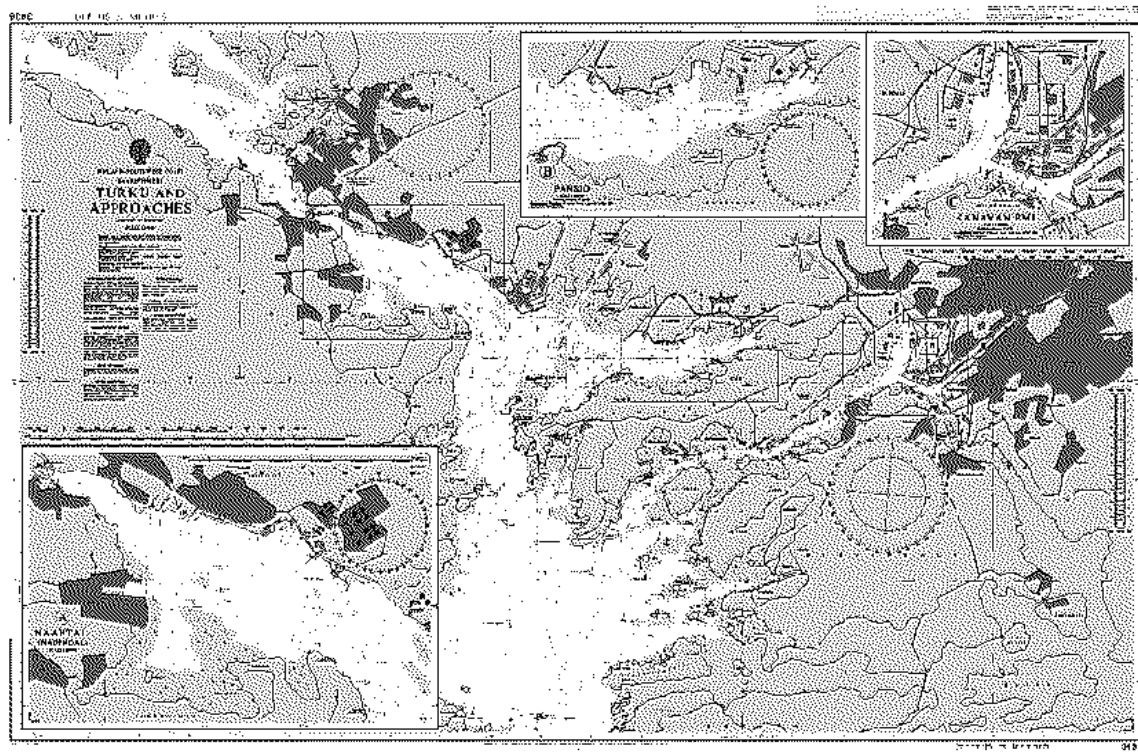

1. In the Voyage navigation mode or the Voyage planning mode, put the cursor at the desired location in the chart area, then right click to select [Chart Legend] to show the [Chart Legend] dialog box. If the own ship mark is at the screen center, the Chart Legend dialog box may be displayed by clicking [Chart INFO] and [Chart Legend] on the InstantAccess bar.
2. Click the [Details] button.
3. Select desired inset from the [Panels] drop-down list.

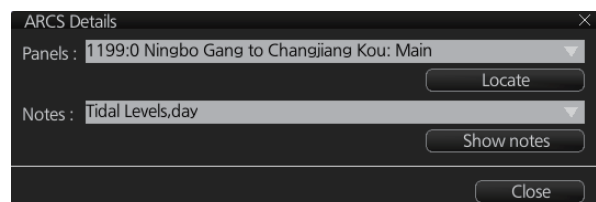

6. RASTER (ARCS) CHARTS

How to display notes of ARCS chart

The operator can select a desired item from the combo box in the [ARCS Details] dialog box in order to view notes for that item. Select an item on the [Notes] combo box then click the [Show Notes] button to show the notes for the selected item.

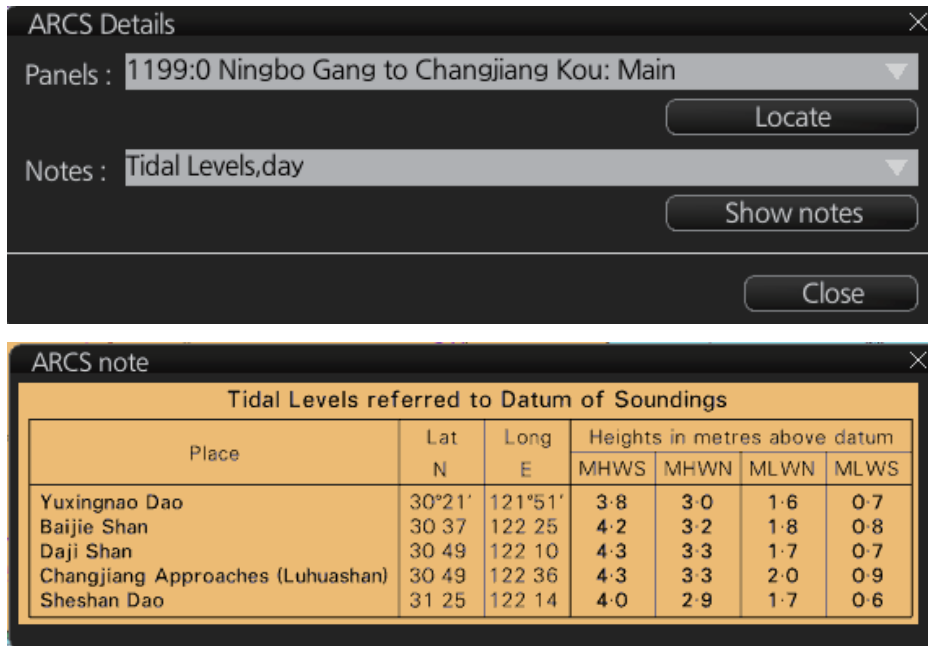

Source Data Diagram (SDD)

A Source Data Diagram (SDD) consists of two parts: a graphic showing the areas covered by each type of source material from which the chart was compiled, and a tabulation, keyed to a graphic, giving details of source dates and scales. The layout of the graphic corresponds to the layout of the chart, and the borders of the diagram equate to the limits of the chart panels. You can show the SDD by selecting [Source] from the Notes drop-down list and clicking the [Show Notes] button.

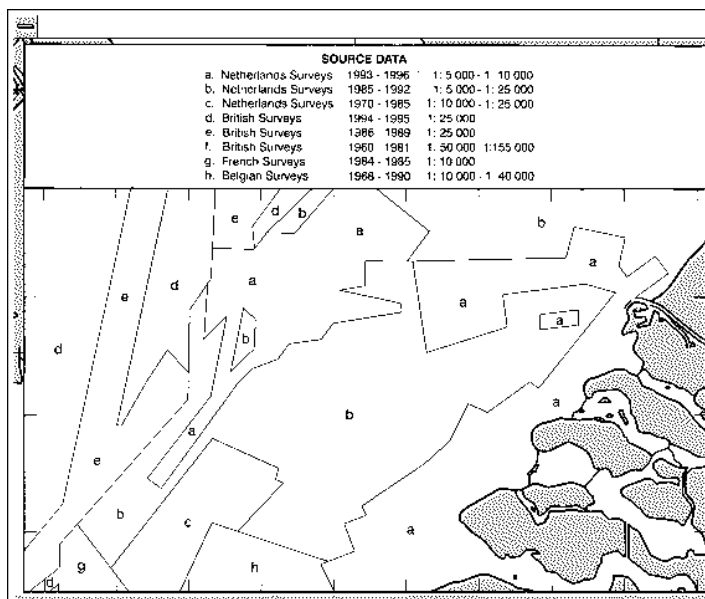

6.2 Datum and ARCS Charts

The difference between ARCS chart local datum and WGS 84 datum is known as WGS 84 shift. This difference is known and the system does the conversion automatically. If the WGS shift for a chart is defined, the amount of shift is indicated. If the WGS shift is not defined, "Undefined" is displayed. For no WGS shift, the indication 0.00°N, 0.00°E appears.

To find the WGS shift of the current chart, in the Voyage navigation or Voyage planning mode, right click the desired area on the chart to show the [Chart Legend] dialog box.

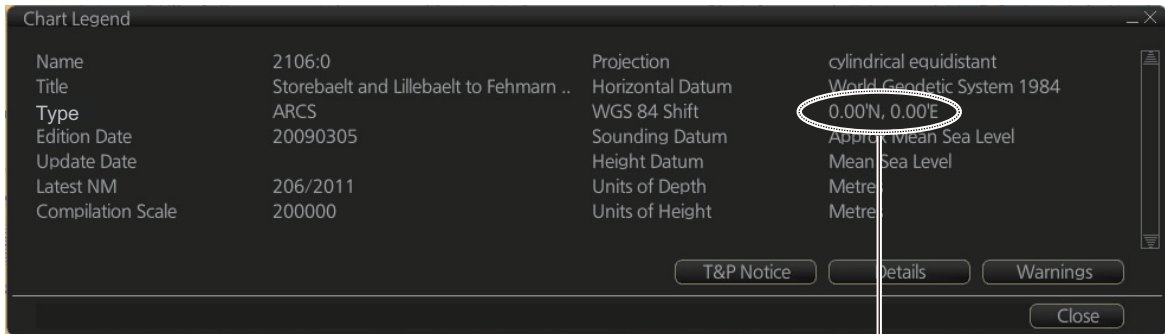

WGS 84 shift indication
(0.00°N, 0.00°E means no shift)

6.3 Permanent Warnings of ARCS

The system can help you to keep your ARCS charts up-to-date for the charts that you have received from ARCS. Producers of ARCS charts store up-to-date status on an ARCS Weekly Update CD-ROM (system files). This information is loaded into the ECDIS when you update, either by permits or by active group. Based on this information, ARCS permanent messages are displayed to help you keep your ARCS charts up-to-date.

Message	Meaning, Remedy
ARCS: permits have expired	You have an expired permit for a chart. Remove the chart or renew subscription for the permit.
No connection to dongle	The dongle is not inserted or not recognized. Insert the dongle to erase the message.

6.4 ARCS Subscriptions

ARCS customers can subscribe to one of two service levels, ARCS Navigator or ARCS Skipper.

Note: If you receive an ARCS chart permit on a floppy disk, copy the contents of the disk to a USB flash memory and then install the permit files.

6.4.1 ARCS Navigator

ARCS Navigator operators receive a comprehensive weekly updating service on a CD-ROM that mirrors the Admiralty Notices to Mariners (NMs) used to correct Admiralty paper charts. The update information is cumulative, ensuring that only the most recent Update CD-ROM is necessary. ARCS Navigator license is valid for 12 months. During this period, weekly updates will be delivered on Weekly Update CD-ROMs. ARCS Navigator is intended for SOLAS class operators who require that their charts are up-to-date.

Content of ARCS Navigator pack:

- One (1) or more Chart CD-ROMs (RC1-RC11) containing ARCS charts
- One (1) Update CD-ROM containing the latest ARCS chart corrections

6.4.2 ARCS license information

Licensee information, which is transferred between participants, is as shown below.

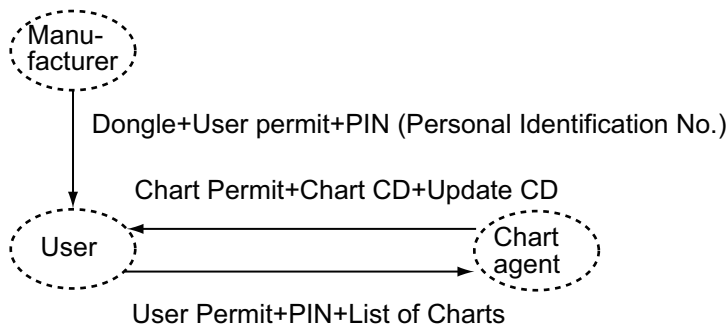

7. C-MAP BY JEPESSEN CHARTS

Your chart system has the capability of using and displaying the latest C-MAP world-wide vector chart database. These charts are fully compliant with the latest IHO S-57 3.1 specifications.

In order to prepare the system for use with the C-MAP database, there are a number of things that must be done.

The descriptions in this chapter apply to C-MAP charts. (This system does not support CM-93/2 charts.)

7.1 How to Register the System at C-MAP

Your system has the capability to use the C-MAP chart database. To do so an eToken (supplied by C-MAP) must be connected to the system. The eToken provides the system with a unique System ID that enables C-MAP to issue correct licenses. The actual System ID can be found on the eToken itself, on the installation medium or on a sticker placed on the equipment. This ID must be provided on all chart orders, by e-mail (license.marine@c-map.com).

7.2 How to Order Charts

A chart order may be sent together with system registration as described above. It is essential that the required information be sent to C-MAP when ordering charts for a system. C-MAP issues order forms specifying the information that is required, and contains vital information that will allow C-MAP to monitor and maintain your licenses throughout the lifetime of the system.

For details on how to order charts see the C-MAP official website (<http://www.c-map.com/>).

7.3 How to Apply for Licenses

Once the order has been received at C-MAP, a license will be generated and transmitted back to the operator. This may be in the form of a single alphanumeric string (16 characters), or in the form of a file called PASSWORD.USR. Once this license has been received it should be input using the License Administrator software designed and supplied by the chart manufacturer. There are two types of licenses, purchase and subscription. Purchase licenses are valid indefinitely while subscription licenses need to be renewed every 12 months from the start of the subscription. Failure to renew a subscription will result in the charts becoming unavailable.

7.4 Troubleshooting

If you are having problems installing your software or charts please check the following before contacting C-MAP:

- Check that the charts are available, with the chart management function.
- Check that the license is correctly installed, with the license function

Contact Information: For information please call you're nearest C-MAP Office (details can be found on the reverse side of the C-MAP chart CO box) or contact C-MAP. E-mail: technical.marine@c-map.com

7.5 Chart Display

7.5.1 Introduction

The two type of C-MAP charts can be displayed together. These charts have the priority order shown below.

- 1) C-MAP ENC
- 2) C-MAP PROFESSIONAL+

If the same navigational purpose charts are available over an area, priority is as shown above. Areas where ENC is not available C-MAP ENC charts are shown. Where C-MAP PROFESSIONAL+ are available, C-MAP PROFESSIONAL+ charts are displayed.

The [Chart Legend] dialog box provides various information about the C-MAP chart currently displayed. The information can be displayed two ways:

- For current position: Click the [TM/CU Reset] button while in the Voyage navigation mode then click the [Chart INFO] button on the InstantAccess bar™ followed by the [Chart Legend] button.
- For a specific location: Put the cursor on the location then right-click and select [Chart Legend]. Click the [Close] button to close the display.

To close the dialog box, click the [Close] button.

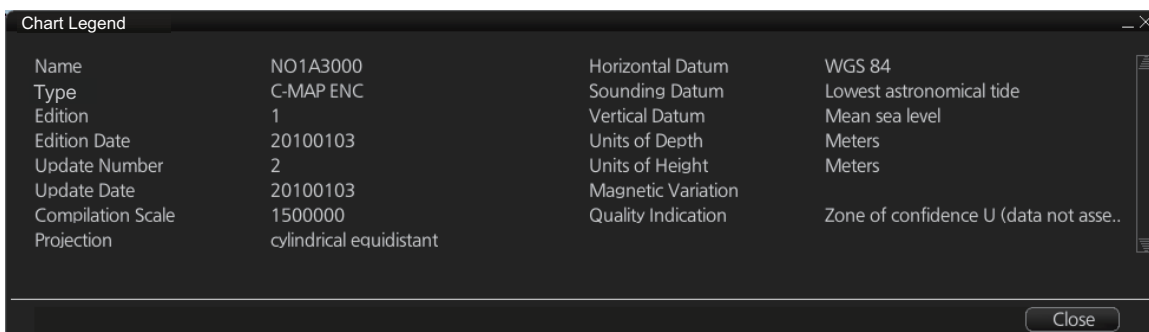

Name: Name of chart.

Type: Type of chart.

Edition: Edition number of the chart.

Edition Date: Date the edition was published.

Update Number: Update number

Update Date: Date of update

Compilation Scale: The scale of the original paper chart is shown here.

Projection: Projection of current chart.

Horizontal Datum: Horizontal datum used with current chart.

Sounding Datum: Datum used to create sounding data.

Vertical Datum: Vertical datum used with current chart.

Units of Depth: Unit of depth used with current chart.

Units of Height: Unit of measurement used to measure height of objects above sea level.

Magnetic Variation: Amount of magnetic variation. A positive value indicates a change in an easterly direction and a negative value indicates a change in a westerly direction.

Quality Indication: Quantitative estimate of the accuracy of chart features, given by the chart producer.

7.6 Permanent Warnings

Permanent warnings help you keep the C-MAP up-to-date and these are shown at the bottom of the screen. Permanent warnings appear if the system detects a condition that may cause a chart to be not up-to-date.

Message	Meaning, Remedy
[C-MAP]: Database not up to date	Database is not up to date. Update the data base.
[C-MAP]: No connection to eToken	eToken dongle is not connected (inside the Processor Unit) or the eToken has not been initialized. If the dongle is connected, open the [License] dialog box, click the [C-MAP] tab, then click the [C-MAP Setup] and [OK] buttons to initialize the eToken.
[C-MAP]: permits have expired	You have an expired permit for a chart. Remove the chart or renew subscription for the permit.
No connection to dongle	The dongle is not inserted or not recognized. Insert the dongle to erase the message.
Permit expired (SSE 25): XXXXXXXX (Chart name replaces Xs.)	You have an expired permit for a chart. Remove the chart or renew subscription for the permit.

7.7 Notice to Mariners (NM)

The NM has been developed to ensure mariners can simply view the information they need - in addition to the standard chart - to navigate safely and compliantly. By clearly showing where important Temporary or Preliminary changes may impact a voyage, the NM will give seafarers the same consistent picture of the maritime environment on their charts as they have always had.

The display and operation methods for NM is essentially the same as AIO. See section 5.5 for details.

How to select the NM information to display

Select what type of notices to display as follows:

1. Click the [DISP], [SET] and [Chart DISP] buttons on the InstantAccess bar.
2. Click the [NtoM] tab.

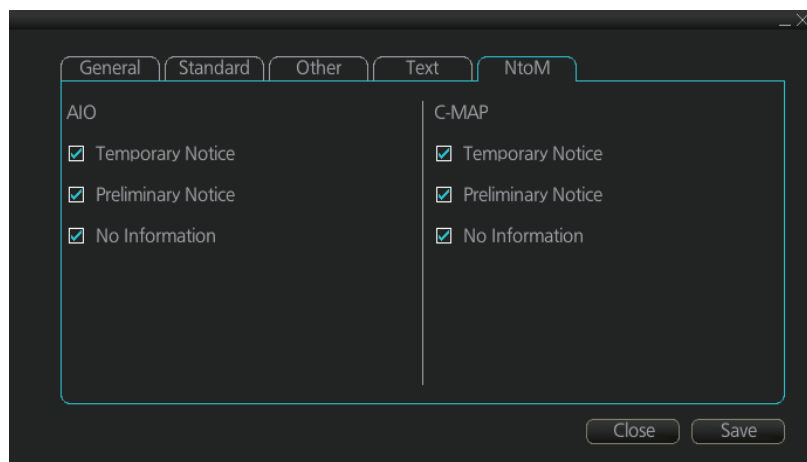

3. In the [C-MAP] window, check the items to display.
4. Click the [Save] button to save settings then click the [Close] button to close the menu.

8. CHART ALERTS

The ECDIS can detect areas where the depth is less than the safety contour or detect an area where a specified condition exists. If prediction of own ship movement goes across a safety contour or an area where a specified condition exists, the system does the following:

- Chart objects set for Alarm category are highlighted in red on the chart (for checking planned route, navigation route).
- Chart objects set for Warning or Caution category are highlighted in yellow on the chart (for checking planned route, navigation route).
- An appropriate message appears in the Alert box for chart objects set for Alarm, Warning or Caution category.
- Chart objects set for Alarm or Warning category are given an aural alarm.

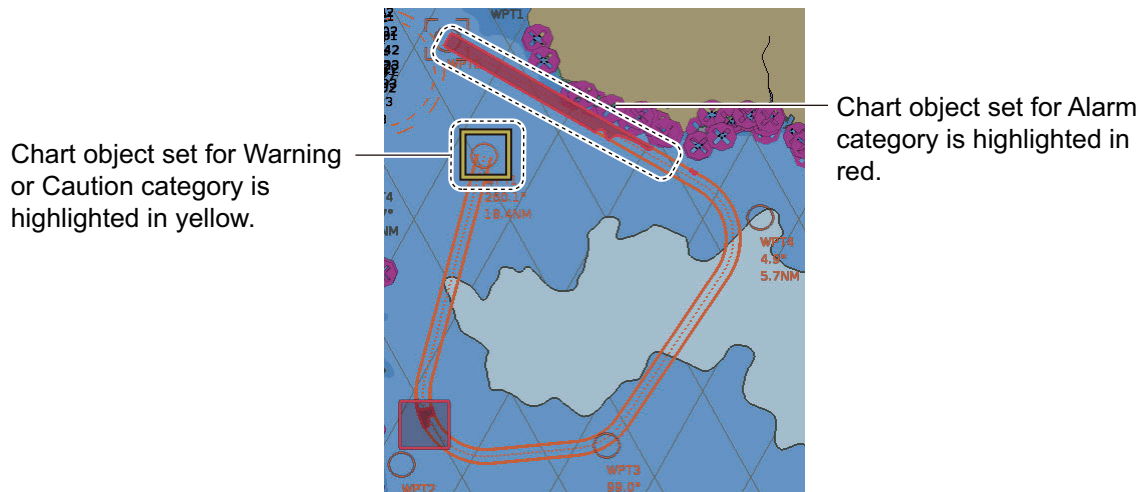

For this function, the ECDIS utilizes the chart database (S57 charts) stored on the SSD in SENC format. **Note that the ECDIS calculates dangerous areas using the largest scale chart available, which may not be the visualized chart.**

You can choose objects that are included for calculation of danger area (for example, restricted areas). A dialog box lists the various areas that activate danger warnings.

You can also define your own safe area by creating a user chart area. The system can utilize these areas when calculating chart alerts.

- The ECDIS can check the following for you:
 - Predicted movement area of own ship
 - Planned route with an easy to use locator function to find dangerous areas
- The ECDIS will highlight the following for you
 - Dangerous areas inside predicted movement area of the own ship
 - Dangerous areas inside your monitored route
 - Dangerous areas inside your planned route

8.1 Chart Alerts

Official S57 chart material contains depth contours that can be used for calculation of chart alerts. A chart database also includes different types of objects that the operator can use for chart alerts. The procedure for setting chart alerts is outlined below.

1. Choose suitable safety contour for your own ship. See the next section for how to set the safety contour.
2. In the Voyage planning mode, define a new route or choose an existing one. Make a chart alert calculation of the route if there are indications of danger areas in the route. Modify your route if necessary and do the chart alert calculation again. To modify an existing route see section 9.5.
3. Choose route as monitored route.
4. Set check area for your own ship.

The system is now ready for chart alert calculation of monitored route and estimated own ship position.

8.1.1 How to set safety contour

Select safety contour suitable for the own ship.

1. Click the [DISP], [SET] and [Chart Alert] buttons on the InstantAccess bar™ to show the [Chart Alert] page.

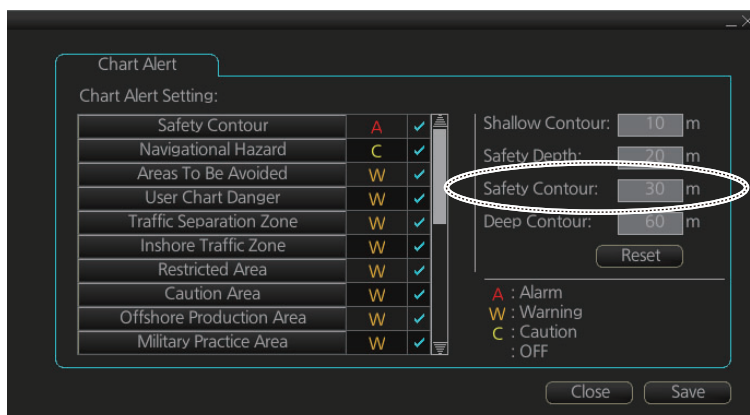

2. Enter desired depth at [Safety Contour] then click the [Save] button.

Any safety contours on the chart are highlighted with a thick gray line.

Note 1: The safety contour is not a new depth contour created by ECDIS - it is the highlight and activation of an existing contour line already present on the chart.

Note 2: If the chart does not contain chosen depth contour, the system will automatically choose next deeper contour.

8.1.2 How to select objects used in chart alerts

You can also include calculation areas that have to be noted when sailing (for example, restricted areas). To include these areas in chart alerts, do the following:

1. Click the [DISP], [SET] and [Chart Alert] buttons on the InstantAccess bar™ to show the [Chart Alert] page.



2. Click a letter indication to select the type of alert, warning or caution, to receive for the given chart object. [Safety Contours] is fixed to "A" (Alarm).
 - **W**: Warning, visual and aural alerts
 - **C**: Caution, visual alert only
 - **No display** (OFF): No alert notification. Available with objects other than [No Vector Chart].
3. Click the box to the right of the letter indication to show a check mark and show the alert. Click the box again to remove the check in the box and hide the alert. Checked alerts are highlighted according to priority:
 - **A** (Alarm): Red color highlight
 - **W** (Warning) and **C** (Caution): Yellow color highlight
4. Click the [Save] button to finish.

Note 1: C-MAP PROFESSIONAL+ charts may take several minutes to identify danger areas.

Note 2: The Type of Alert setting must be the same for all connected FMD-3x00/FAR-3xx0/FCR-2xx9.

List of areas

There are the areas that the ECDIS detects and provides the audible alert and/or visual alert if estimated own ship position or planned or monitored route crosses the area defined on the [Chart Alert] page. You can choose from the following areas:

- Safety Contour
- Navigational Hazard
- Areas To Be Avoided
- User Chart Danger
- Traffic Separation Zone
- Inshore Traffic Zone
- Restricted Area
- Caution Area
- Offshore Production Area
- Military Practice Area
- Seaplane Landing Area
- Submarine Transit Lane
- Anchorage Area
- Marine Farm/Aqua Culture
- PSSA Area
- No Vector Chart
- Too Many Dangers
- UKC Limit
- Sounding UKC Limit
- Non-official ENC
- Not Up-to-date
- Permit Expired

8.2 How to Activate Own Ship Check

Calculation of own ship predicted movement area is done using a check area (two places) about own ship position. Set the check area as follows:

1. Select the [Look-ahead] page from the [Overlay/NAV Tools] box.
2. Referring to the figure below, set the ahead time or distance and ahead width. Also, set the "Around" figures: port, starboard, bow and stern check distance.

The reference point is the conning position (CCRP).

Both areas are shown as a thin black line one screen.

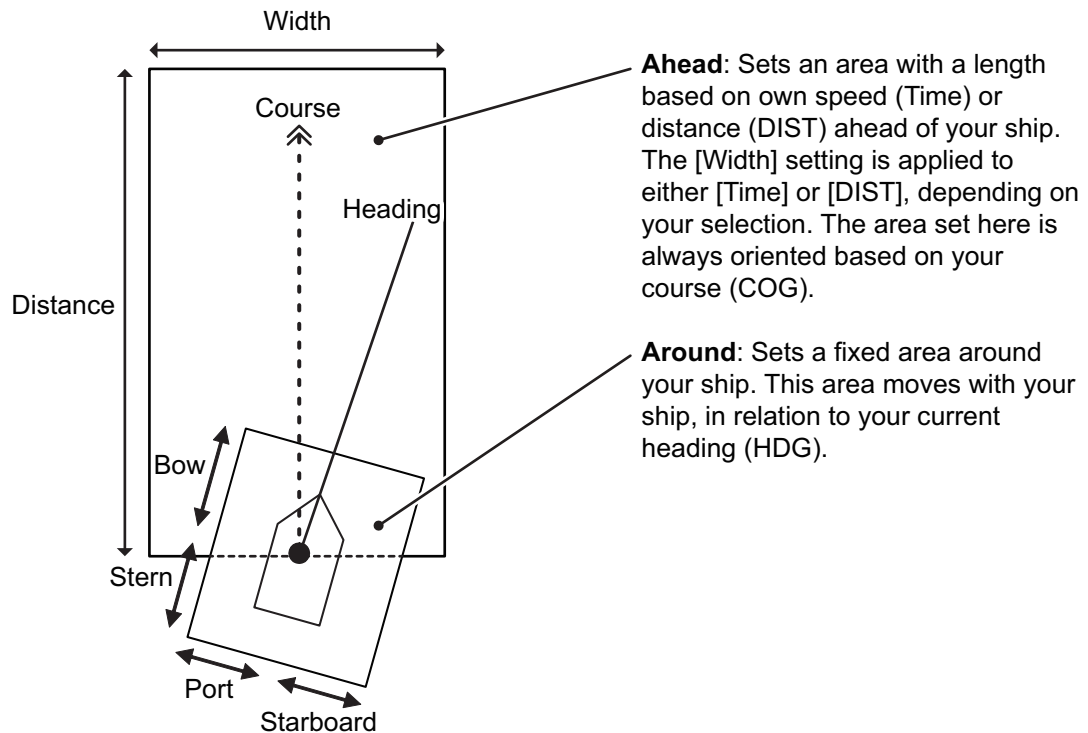
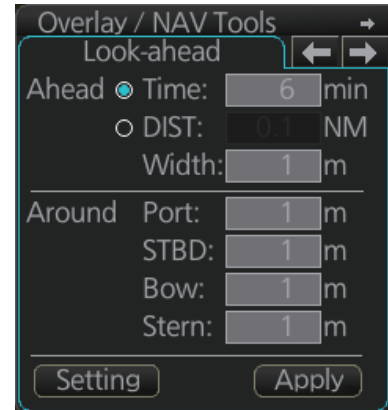

3. To select the objects to use in chart alerts, click the [Chart Alert] button and see section 8.1.2.
4. Click the [Apply] button to affect the changes.

When an object set from the [Chart Alert] menu enters a set area, an alert is generated in the following manner:

- Alarm or Warning level alerts: Alert message and aural alert are generated.
- Caution level alerts: Alert message is generated (no aural alert).

Objects or areas that generate an alert are shown in the following manner. (Alarms: red highlight, Warnings/Cautions: yellow outline)

- Individual objects: The object is highlighted in red or outlined in yellow.
- Area objects: If the area object is larger than the look-ahead area, the look-ahead area is highlighted in red or outlined in yellow. If the area object is smaller than the look-ahead area, the area object is highlighted in red or outlined in yellow.

8.3 Route Planning

The system will calculate chart alerts using user-defined channel limit for routes. Danger areas are shown highlighted if safety contour or user-chosen chart alert areas are crossed by the planned route. For more information on route planning, see chapter 9.

Note: If your voyage is going to take a long time or you are planning it much earlier than it is to take place, use the Display date and Approved until dates corresponding to the dates you are going to sail.

8.3.1 Chart alerts for route planning

You can generate a list of chart alerts that cross by the planned route. This can be done as follows:

1. Enter safety contour you want to use.
2. Plan a route; define waypoints and other necessary information. See chapter 9.
3. Select dangerous objects to be monitored during route monitoring, on the [Alert Parameters] page in the [Route Plan] dialog box, shown below. Click the box below each object to show or hide the check mark.

When the route is checked, alert objects with a check mark which have their alert activated are highlighted on the chart display. Alert objects with no check mark are not highlighted.



4. Click the [Check Route] button to generate a list of chart alerts. The results appear on the [Check Results] page.



The figure above shows the alerts to be monitored. If there are alerts included in the planned route, check alerts leg by leg, or check alerts by using category of alert.

Note: When alerts are unchecked at step 3 in the above procedure, one or more of the following messages appear in the permanent warning box.

8. CHART ALERTS

- [Safety Contour] unchecked: "Indication of crossing safety contour if Off. (in planning)"
- [Navigational Hazard] unchecked: "Indication of navigational hazards is Off. (in planning)"
- Other alerts unchecked: "Indication of some prohibited areas or areas with special conditions is Off. (in planning)"

9. ROUTES

9.1 Route Planning Overview

A route plan defines the navigation plan from starting point to the final destination. The plan includes:

- Route name
- Name, latitude and longitude of each waypoint
- Radius of turn circle at each waypoint
- Safe channel limits
- Chart alarm calculation based on channel limits against chart database and user chart danger
- UKC calculation
- Deadband width, nominal deadband width used for operating modes with moderate accuracy and economical sailing behavior
- Minimum and maximum speed for each leg
- The navigation method (rhumb line, great circle)
- Fuel saving
- ETD from each waypoint
- ETA to each waypoint
- Ship and environmental condition affecting the ship speed calculation
- Name of the user chart to use during route navigation together with the planned route
- Name of the Notes to use during route navigation together with this planned route, in the user chart dialog box

Using the above-mentioned data, the system calculates speed, course and length for each leg, ETAs for each waypoint, fuel consumption and WOP. It also calculates safe water areas based on user-defined channel limits. The calculated data is displayed in tabular form, which can be printed as a documented route plan and also stored in a file for later use.

Main functions of route planning are:

- Define waypoints (a maximum of 200 waypoints per route)
- Define turnings for each waypoint
- Define channel limits for each leg (a leg is the line connected between two waypoints). The channel limits are used to detect chart alerts when you are planning or monitoring your route.
- Define the speed for each leg
- Calculation for ETD and ETA
- Calculation for most economical sailing

Note 1: Limitation of displayed route

If you have small scale chart(s) on display having the whole eastern/western (0-180°E/0-180°W) hemisphere and a part of the other hemisphere on display, there is a limitation to display a route. To avoid this, set chart center so that the whole eastern/western hemisphere is not on the display. A maximum of five routes can be edited simultaneously.

Note 2: If a planned route's Safety Margin or Channel Limit contains excessive land masses, the ECDIS may freeze during a route check. When this happens, reset the ECDIS, then adjust the Channel Limit and Safety Margin settings in the Route Plan dialog box's Waypoints so that land mass is not included in the route.

9.2 Main Menu for Route Planning

The main parameters for the route planning are:

- Latitude and longitude of the waypoint
- Channel (XTD) limits to the waypoint
- Turning radius of the waypoint
- Maximum speed limit and planned speed for each leg

There are two phases for a route: Route Plan and Route Monitor. Route plan is used for planning the route and route monitor is used to control a route for monitoring.

To complete route planning, do the following.

1. Create a new route or choose an existing one. See section 9.4.
2. Modify your route if necessary. See section 9.5.
3. Make chart alert (safe water) calculation. See section 9.4.5.
4. Optimize your route. See section 9.8.

9.3 How Route Data is Synced

Route data can be shared between this ECDIS and other like units (FMD-3x00, FCR-2xx9, FAR-3xx0), through the LAN. A minimum of two units is required. Turn on all units beforehand to enable syncing. The sync source (master unit) is automatically assigned by the system when each unit is powered. For configurations with three or more units, two units are assigned as a sync source and have priority regardless of their power status (ON or OFF). The priority is assigned as follows:

- 1) ECDIS unit assigned as the Planning ECDIS.
- 2) ECDIS unit assigned with the lowest unit number at installation.
- 3) Chart Radar unit assigned with the lowest unit number at installation.

Be aware that if a unit is turned off, some route data may be deleted. Two examples are shown below.

Using ECD001 and ECD002

This example assumes that ECD002 is assigned as a Planning ECDIS.

1. ECD002 is off; ECD001 is powered and a route is created at ECD001. Even though ECD002 is the Planning ECDIS, route data is not transferred to ECD002 because the power is turned off.
2. ECD002 is turned on. As this unit is assigned as a Planning ECDIS, ECD001's route data is deleted.

Using ECD001, ECD002 and CRA001

This example assumes that ECD001 and ECD002 is assigned as a Planning ECDIS.

1. ECD001/002 are both turned off; CRA001 is powered and a route is created on CRA001. Route data is not transferred as both ECD001 and ECD002 are turned off.
2. ECD001 is turned on. As this unit is assigned as a Planning ECDIS, CRA001's route data is deleted.

If the operator clicks the PLAN button on the Status bar when one or more units (including the master unit) is turned off, one of the following messages appears. Turn all units in the same network on, then plan or edit the route as required.

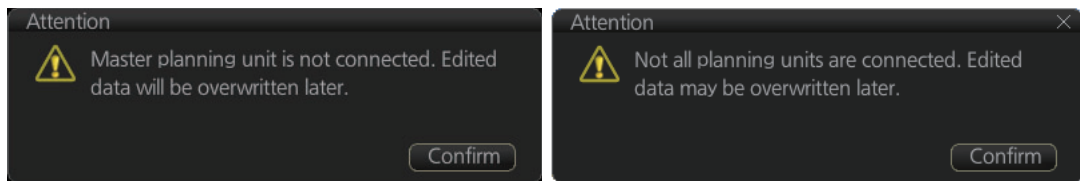

9.4 How to Create a New Route

To make a complete route for a voyage, do the following:

1. Click the [PLAN] button on the Status bar to activate the Voyage planning mode.
2. On the InstantAccess bar™, click the [Planning] button followed by the [Route] button to open the [Route Plan] dialog box.

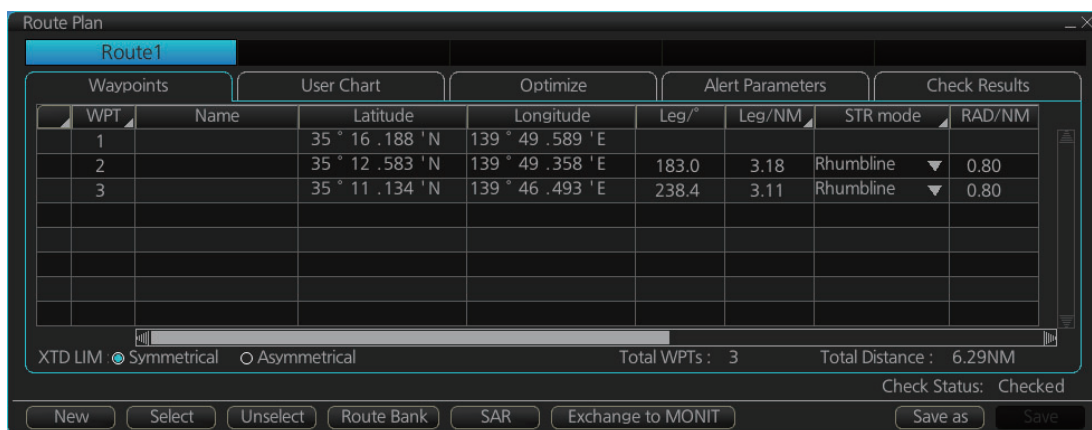

3. Click the [New] button.

Note: If, after pressing the [New] button, the database cannot be accessed, the message "Database access failure occurred. You can make a route but cannot save it." appears. In this condition you can make a route and use it for navigation, but you cannot save it. Contact a FURUNO dealer for instruction.
4. Use the cursor to select a position for the first waypoint then push the left mouse button. A waypoint mark appears on the position selected. The latitude and longitude of the position are entered into the [Route Plan] dialog box. The waypoint number appears in the [Waypoint] column. The latitude and longitude can be edited from the [Route Plan] dialog box. After entering a waypoint, you can edit Name, Steering mode*, Radius*, Channel limit*, Plan SPD*, SPD Max*, and Margin*. (* For waypoint 2 and after only.) For how to edit data, see section 2.1.13.

Note 1: A guide box that shows the range and bearing between waypoints as you drag the cursor is available. You can show or hide the box with the [Guide Box] button on the InstantAccess bar™. Click the button to show its background color in light-blue to display the guide box.

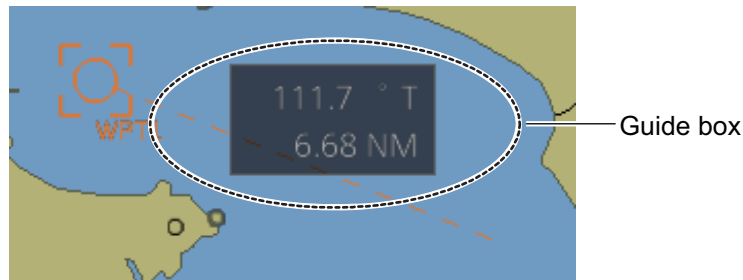

Note 2: The bearing and range of the waypoint can be adjusted as shown below.

- 1) In the Route Plan dialog box, right click the bearing or the distance of the waypoint to change.
- 2) Select [Adjust Position] to show the [Adjust Waypoint] context menu shown right.
- 3) Enter value at [Direction] or [Distance], then click the [OK] button.

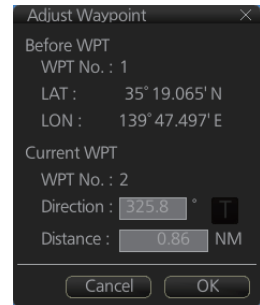

5. Repeat step 4 to enter other waypoints.
6. After you enter the final waypoint, right-click the display area to show the context-sensitive menu then select [Finish].
7. Click the [Save] button. Enter a name (max. 63 characters) for the route, using the software keyboard. Click the [OK] button to finish.
8. Use the [Alert Parameters] page to define the safety contour and other specified conditions for checking the route. Click an item to place a check in the box, highlighting that type of chart alert area. Also, input value for [Draught/m]. A parameter for [Draught/m] can also be assigned globally to all legs from the context-sensitive menu. See section 9.4.4 for how to use the [Alert Parameters] page.
9. Use the [Check Route] button on the [Alert Parameters] page to detect areas where the depth is less than the safety contour or where specified conditions exist. The results appear on the [Check Results] page. This system can examine chart database against planned route to make a list of alerts where a route crosses a safety contour or specified areas used in chart alerts.
10. Use the [User Chart] page to link, de-link a user chart(s) with the route. See section 9.4.2.

- Use the [Optimize] page to enter parameters for route optimization. See section 9.4.3.

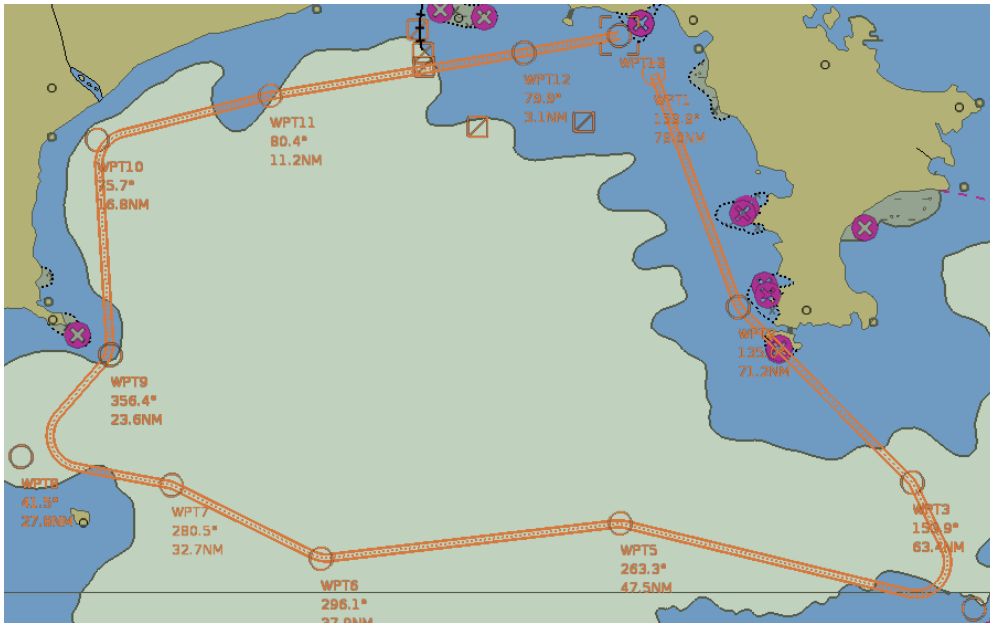

- Click [Save]. The [Save Route] dialog appears.
- Input a name for the new route, then click [OK]. The route is now saved in the Route Bank.

How to use the Undo feature

The Undo feature, available when creating a route and a user chart, can be accessed from the [Undo] button on the InstantAccess bar™. In route creation the feature is used with waypoint and text input as follows:

Waypoint input: Delete last-entered waypoint.

Text input: Erase last-entered character or character string.

9.4.1 How to use the Waypoints page

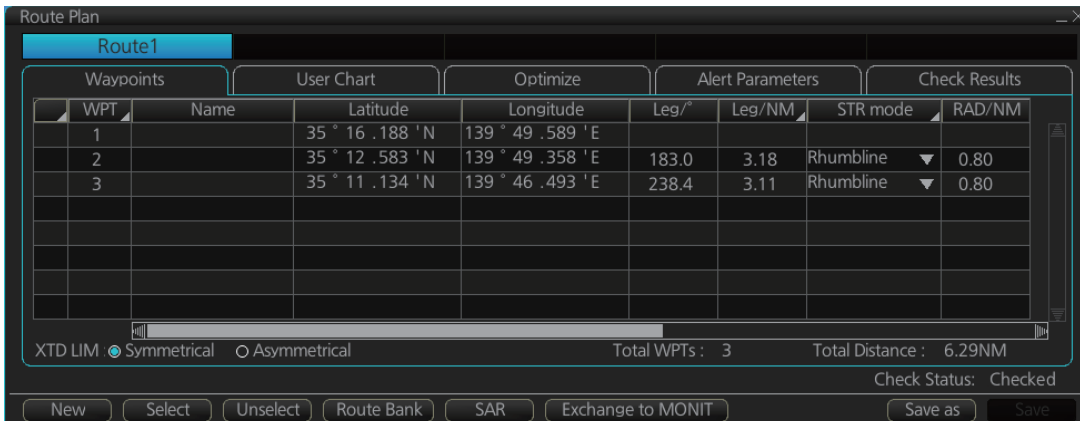

The following fields and boxes can be found in the [Waypoints] page. Scroll the list rightward to see hidden items.

<p>WPT: Each waypoint has a number.</p> <p>Name: You can name each waypoint.</p> <p>Latitude: WPTs latitude coordinate is displayed in WGS-84 datum.</p> <p>Longitude: WPTs longitude coordinate is displayed in WGS-84 datum.</p> <p>Leg/°: Bearing of leg (True: reference to North). The bearing of legs can be changed. Right click a bearing to show the context sensitive menu. Select [Adjust Position], then set bearing in the pop-up window.</p> <p>Leg/NM: Length of leg (nm). The display method can be changed by right clicking the column title to show the context sensitive menu. [Each] shows the distance of each leg. [Total] shows the total cumulative distance from leg to leg. [Remain] shows the distance remaining from leg to leg. Note that these settings are reflected to [Leg/NM] in the [Waypoints] page of the [Monitor Information] dialog box.</p> <p>Str Mode: Define steering mode for each leg - rhumb line or great circle. Click to select [Rhumbline] or [Greatcircle].</p> <p>RAD/NM: Define turning radius for each waypoint. To change a radius, put the cursor in this column to show up and down arrows. Click the arrows to set the radius.</p>	<p>XTD LIM/m: The radio button [XTD LIM] determines how to set the channel limits. The [Symmetrical] setting shows [XTD LIM/m] in the setting window, indicating that the port and starboard channel limits are equal. [Asymmetrical] replaces [XTD LIM/m] with [XTD Port/m] and [XTD Starboard/m], allowing individual setting of port and starboard channel limits.</p> <p>Plan SPD: Define planned speed to use with a leg.</p> <p>SPD Max: Define maximum speed to use with a leg.</p> <p>Margin/m: Define extension for channel limits to be checked against chart alerts.</p> <p>PL 1/m, PL 2/m: One or two sets of parallel lines, colored orange, can be drawn on a route. Set the distance (in meters) to offset the lines from the route, from -99999 to 99999. Parallel lines allow the navigator to maintain a given distance away from hazards. See the illustration below.</p> <p>XTD LIM (radio button): Selects how to set channel limits - port and starboard channel limits are equal or not equal</p> <p>Local Time: Use local time. Enter the time difference between UTC and local time.</p>
--	--

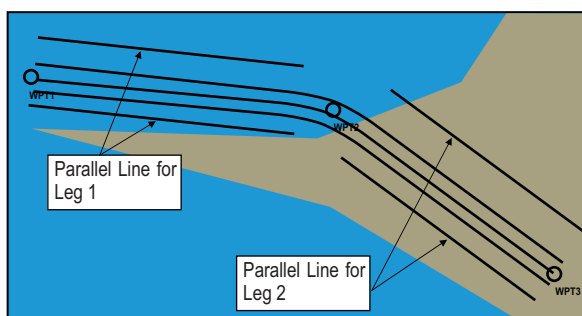

Note: You can select the route information data to display on the [Waypoints] page with the context-sensitive menu. Right click the “Edit Columns” to show the context-sensitive menu. Check or uncheck items as appropriate then click the [OK] button.

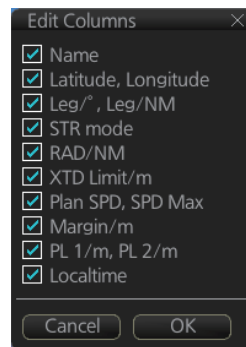

9.4.2 How to use the User Chart page

The [User Chart] page lets you link user charts to routes. To link a user chart, click the box to the left of the user chart name in the [Stored User Chart] list to show a checkmark. Click the << button to copy that name to the [Linked User Chart] list. To de-link a user chart, click the box to the left of the user chart name in the [Linked User Chart] list then click the >> button to erase the name. The contents of each user chart are shown in the [Contents] window.

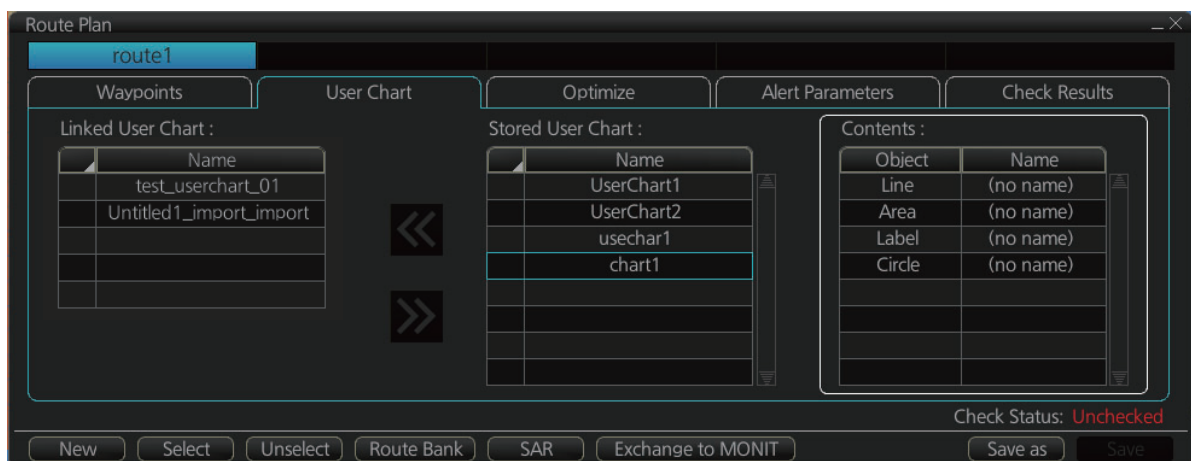

Linked User Chart: List of user charts linked with selected route.

Stored User Chart: List of stored user charts.

<< button: Link a stored user chart. Check the chart in the [Stored user chart] list then click this button. The user chart name is then copied to the [Linked User Chart] list.

>> button: Click to remove selected (checkmarked) user chart from the [Linked User Chart] list.

Contents: Lists the objects saved to the user chart selected.

9.4.3 How to use the Optimize page

After all waypoints are inserted and you have made safe water calculation, you can optimize your route, on the [Optimize] page. If not chosen, then optimization will be done automatically with max. speed. If you want do optimization with a specific strategy, see section 9.8 for how to optimize a route.



Type: Select optimization strategy: maximum speed, time table, maximum profit, or minimum cost.

Set ETD: Set date, time and waypoint to start from.

Parameters: Set the parameters for optimization, speed limit and income (max profit).

Edit Cost Parameters button: Enter fuel consumption figures. See section 21.3.

Set ETA: For the type [Time table], set the date and time that you want to arrive at the waypoint selected.

Optimized Speed/ETA: The optimized speed for the date and time entered at [Set ETA] appears here, after clicking the [Calculate] button.

Clear All: Clear all ETD dates entered at [Set ETD].

Calculate button: Click to calculate optimization.

Apply to Route button: Apply the optimizations to the current route.

9.4.4 How to use the Alert Parameters page

The [Alert Parameters] page sets the alert conditions to use when checking a route. Put a “W” for an item to highlight on the chart. ([Safety Contour] is fixed to “A” (Alarm). If you do not require the highlight display for an item, put a “C” for that object. The relevant alerts (Alarm, Warning, Caution) are shown in the [Check Results] page.

You can select the safety contour and chart alerts used to check the safety of the route. This allows you to check the safety with conditions different from those chosen for system use. This is useful when making a route for different loading or sailing conditions.

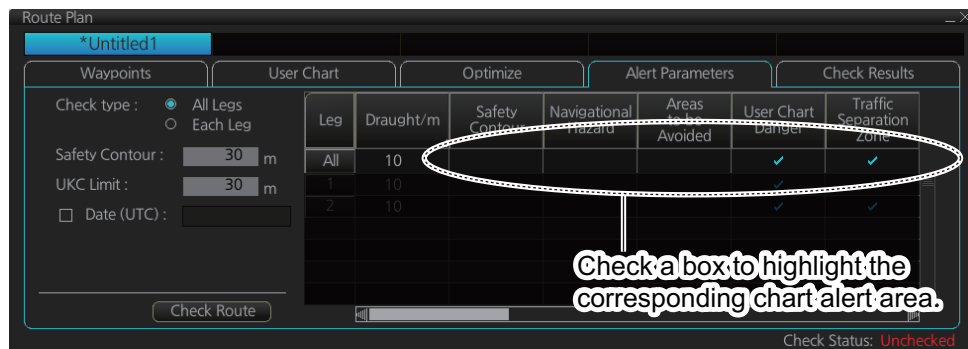

Item	Description	Item	Description
Check type	Check how to apply the alerts, to every leg or individual leg. (Only [Draught] can be applied to every leg.)	Caution Area	Caution area
Safety Contour	Set the safety contour (in meters).	Offshore Production Area	Offshore production area
UKC Limit	Set UKC limit.	Military Practice Area	Military practice area
Date (UTC)	A chart may have date-dependent features. Enter the actual data of embarkation to know date-dependent features.	Seaplane Landing Area	Seaplane landing area
Check Route button	Check route for safe navigation, The results are shown the [Check Results] page.	Submarine Transit Lane	Submarine transit lane
Draught/m	Ship's draught	Anchorage Area	Anchorage area
Safety Contour	Safety contour	MarineFarm Aquaculture	Marine farm aquaculture
Navigational Hazard	Navigational hazard.	PSSA Area	Particularly Sensitive Sea Area
Areas to be Avoided	Areas to be avoided	No Vector Chart	No vector chart for area
User Chart Danger	User chart danger area	Too Many Dangers	Too many dangers area
Traffic Separation Zone	Traffic separation zone	UKC Limit	Under keel clearance limit.
Inshore Traffic Zone	Inshore traffic zone	Sounding UKC Limit	Under keel clearance limit.
Restricted Area	Restricted area	Non-official ENC	No official ENC data

Item	Description	Item	Description
Permit Expired	Permit for chart has expired.	Not Up-to-date	Chart not up to date.

Context sensitive menus

A context-sensitive menu for setting the draught is available on the [Alert Parameters] page. Right-click [Draught] to show the menu. [Set “ALL” setting to all legs] applies the draught value of [Check type: All Legs] to all legs. [Clear setting] restores default settings for each leg.

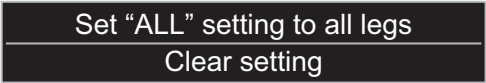

9.4.5 How to use the Check Results page

The [Check Results] page allows you to make safe water calculation for your route. Click the [Check Route] button to do the check. After the button is operated, the alert type and latitude and longitude position of the alert appear for applicable legs on the route.

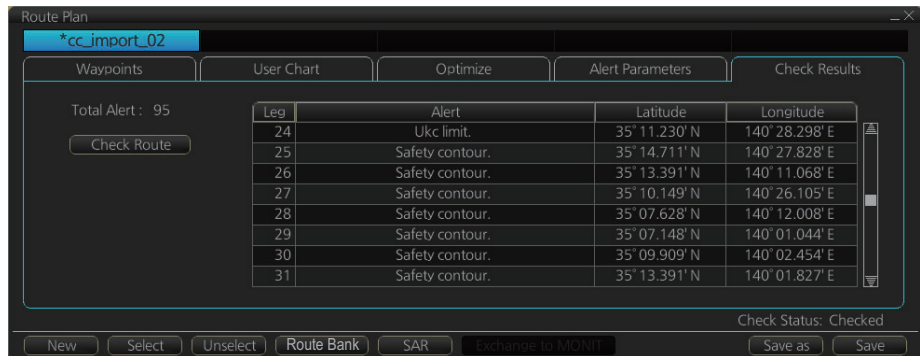

Note 1: In order to display charts with correct updated situation, always use current date during your voyage. If your voyage lasts more than one week, set current date at least once per week during your voyage.

Note 2: A route check can take longer with C-MAP charts. Wait until the completion of the check.

Note 3: After a chart update (including installing charts) is done, redo the route check (with [Check Route] button) on a route before using it for navigation, to confirm that the route is safe against updated charts. Also redo a route check whenever another unit in the network has updated charts while monitoring a route. When you attempt to use the instant track feature without doing a route check, the message “Not checked against ENC chart” appears in the permanent warning dialog box.

9.5 How to Modify an Existing Route

9.5.1 How to change waypoint position

To change position of a waypoint you have the following choices:

- Enter latitude and longitude on the [Waypoints] page in the [Route Plan] dialog box.
- Drag and drop waypoint using the left button.

How to drag and drop waypoint to new position

1. Put the cursor on the route waypoint to move then push the right button to show the context-sensitive menu.
2. Select [Edit].
3. Press and hold down the left button while rolling the trackball to move the cursor to a desired position. Release the button when the cursor is at the desired position. Right-click the display area to show the context-sensitive menu then select [Finish].

How to change latitude and longitude from the Waypoints page

1. Show the [Waypoints] page.
2. Put the cursor on the digit to change in the Latitude or Longitude field.
3. Enter position by spinning the scrollwheel.

9.5.2 How to change other waypoint data

Other data of a waypoint, such as name, steering mode, turning radius, min/max speed, can be edited from the [Waypoints] page. Select the route to edit and open the [Waypoints] page. Put the cursor on a desired field and spin the scrollwheel to change data. (Push the left button to change steering mode.)

9.5.3 How to add a new waypoint at the end of a route

How to add a new waypoint at the end of a route from the electronic chart area

1. Put the cursor on the current last waypoint of the route.
2. Right-click the display area to show the context-sensitive menu then click [Edit].
3. Put the cursor on the new location for the last waypoint then push the left button.
4. Right-click, then click [Finish].

How to add a new waypoint at the end of a route from the Waypoints page

Open the [Waypoints] page, right-click [WPT] then select [Add WPT]. A waypoint is added at the end of the list. Edit the Latitude, Longitude, etc. as necessary.

9.5.4 How insert a waypoint

How to insert a waypoint between waypoints from the electronic chart area

1. Put the cursor anywhere on the route where you want to insert a waypoint.
2. Right-click to show the context-sensitive menu then click [Edit].
3. Put the cursor on the leg where you want to insert a waypoint.
4. Right click then click [Insert WPT].
5. Right click then click [Finish].

How to insert a waypoint from the Waypoints page

Open the [Waypoints] page then right-click the waypoint to process. Select [Insert after] or [Insert before] as appropriate. A waypoint is added after or before the waypoint selected. Edit the Latitude, Longitude, etc. as necessary.

9.5.5 How to delete a waypoint

How to delete a waypoint from the electronic chart area

Put the cursor on the waypoint to delete. Push the right button to show the context-sensitive menu then select [Edit] followed by [Delete WPT].

How to delete a waypoint from the Waypoints page

Open the [Waypoints] page. Right-click the waypoint you want to delete then select [Delete WPT].

9.5.6 Geometry check of route

When you add a new waypoint, modify a waypoint or change other waypoint data, the geometry check may reveal problems with the route. The problem(s) are indicated in red and an appropriate message appears, also in red, on the [Waypoint] page. Refer to the descriptions in this section for the geometry check error messages and the remedies necessary to fix the route.

“Impossible turn at WPT XX” (XX=WPT no.)

The error message, next longitude and latitude and/or a turn radius appear in red.

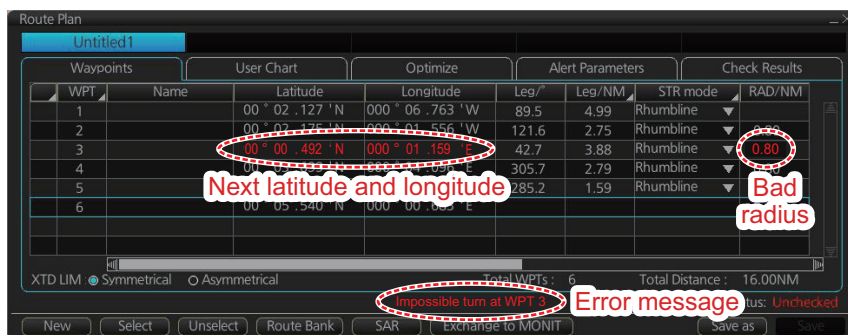

This means that the geometry of route makes it impossible for the ship to accomplish a turn. Typically, it is sufficient if you do the following, on the [Waypoints] page.

- Decrease the turn radius of the waypoint.
- Change latitude and longitude position of the waypoint or one of its neighbors.

“Bad Leg WPT XX to WPT XX” (XX=WPT no.)

The error message and a pair longitude and latitude appear in red.

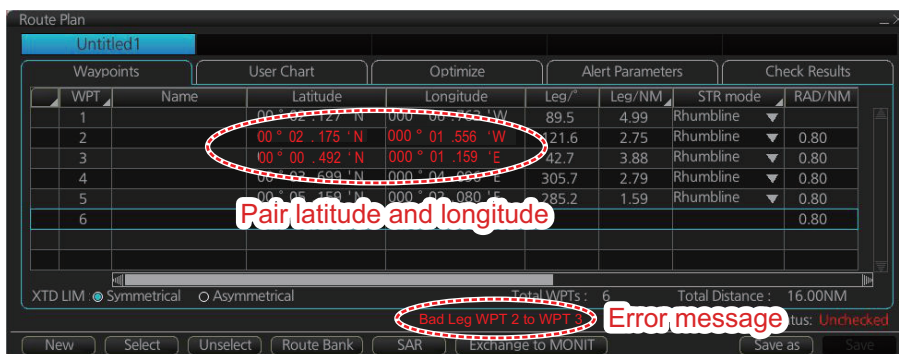

This means that the length of a leg is too short to accomplish a turn. Typically, it is sufficient if you do the following, on the [Waypoints] page.

- Change latitude and longitude position of the waypoint or one of its neighbors.

“Bad Turn at WPT XX” (XX=WPT no.)

The error message, turn radius and planned SPD indication (not shown in the figure below) appear in red.

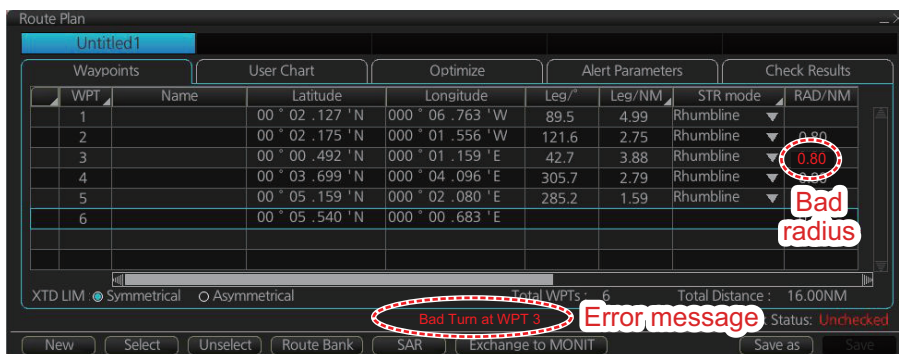

This means that the turn cannot be accomplished because the calculated ROT exceeds the MAX ROT. Typically, it is sufficient if you do the following, on the [Waypoints] page.

- Increase the turn radius of the waypoint.
- Decrease the planned SPD.

9.6 SAR Operations

The SAR feature facilitates search and rescue operations for MOB.

To use the SAR feature, get into the Voyage planning mode then do the following:

1. Click the [Planning] and [Route] buttons on the InstantAccess bar™ to show the [Route Plan] dialog box then click the [SAR] button.

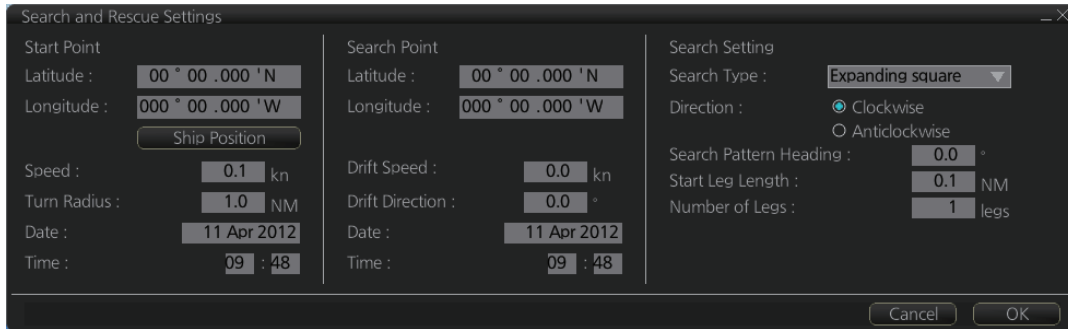

2. Enter your start point. To enter current position, click the [Ship Position] button. (The start point can also be entered directly on the screen. Put the cursor on the start point, right-click the chart to show the context-sensitive menu shown below then click [Set start point].)
3. Enter your ship's speed and turn radius, current UTC date and time.
4. At [Search Point], enter the estimated position of the object to search. (The search point can also be entered directly on the screen. Put the cursor on the search point, right-click the chart to show the context-sensitive menu shown at step 2 then click [Set search point].)
5. Enter drift speed, drift direction, and the UTC date and time of the estimated position.
6. At the [Search Setting] window, choose and set the search type, referring to the table on the next page.

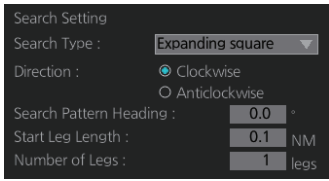
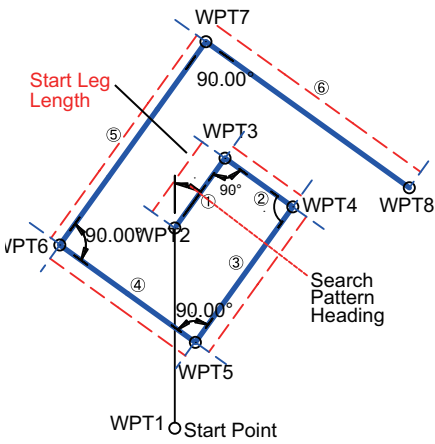
Search type	Options	Sample pattern
Expanding square	 <p>Direction: Set the direction to start the search, Clockwise or Anticlockwise. Search Pattern Heading: See the right figure. Start Leg Length: Enter the start leg length. Number of Legs: Enter the number of legs to use. Starting at the probable location of the target, the search vessels expand outward in concentric squares.</p>	

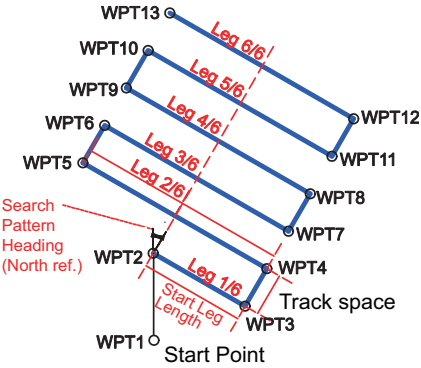
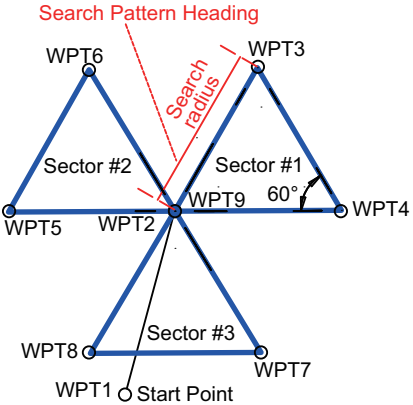
Search type	Options	Sample pattern
<p>Parallel tracks</p>	<div data-bbox="611 248 954 459" style="border: 1px solid black; padding: 5px; margin-bottom: 10px;"> <p>Search Setting</p> <p>Search Type : Parallel tracks</p> <p>Direction : <input checked="" type="radio"/> Clockwise <input type="radio"/> Anticlockwise</p> <p>Search Pattern Heading : 0.0 °</p> <p>Start Leg Length : 0.1 NM</p> <p>Track Space : 0.1 NM</p> <p>Number of Legs : 1 legs</p> </div> <p>Direction: Select the direction to start the search, Clockwise or Anticlockwise.</p> <p>Search Pattern Heading: See the right figure.</p> <p>Start Leg Length: Enter the start leg length.</p> <p>Track Space: Enter the length of the short legs in the route.</p> <p>Number of Legs: Enter the number of legs to use.</p> <p>The parallel tracks pattern is usually the first pattern used in undertaking a search operation, since it assumes that the search object is in the vicinity of the track.</p>	
<p>Sector search</p>	<div data-bbox="611 1077 946 1256" style="border: 1px solid black; padding: 5px; margin-bottom: 10px;"> <p>Search Setting</p> <p>Search Type : Sector search</p> <p>Direction : <input checked="" type="radio"/> Clockwise <input type="radio"/> Anticlockwise</p> <p>Search Pattern Heading : 0.0 °</p> <p>Search Radius : 0.1 NM</p> <p>Number of Sectors : 1</p> </div> <p>Direction: Select the direction to start the search, Clockwise or Anticlockwise.</p> <p>Search Pattern Heading: See the right figure.</p> <p>Search Radius: Enter the search radius (in NM).</p> <p>Number of Sectors: Enter the number of sectors to use.</p> <p>The sector search is used when the position of the body is known accurately and the search has to be done over a small area. It is normally carried out in the area, where the casualty or the object has been sighted.</p>	

- Click the [OK] button. The [Route Plan] dialog box appears and the system draws the search and rescue route on the screen according to the search and rescue settings.

9. ROUTES

- To follow the route, click the [Exchange to MONIT] button.
Note: To monitor the route the following conditions must be met:
 - The route must have at least two waypoints.
 - The route must have no impossible turns.
 - The route must have no bad turns.
 - The route must have no bad legs.
 - The route must have been checked.
- To save the route, click the [Save] button and enter a name for the route, using the software keyboard.

If necessary you can drag waypoints to new position, like with an ordinary route.

9.7 Route Bank

The route bank stores all the routes you have created. To show the route bank, in the Voyage planning mode, select [Route], [Route Bank] in [Route Plan] dialog box:

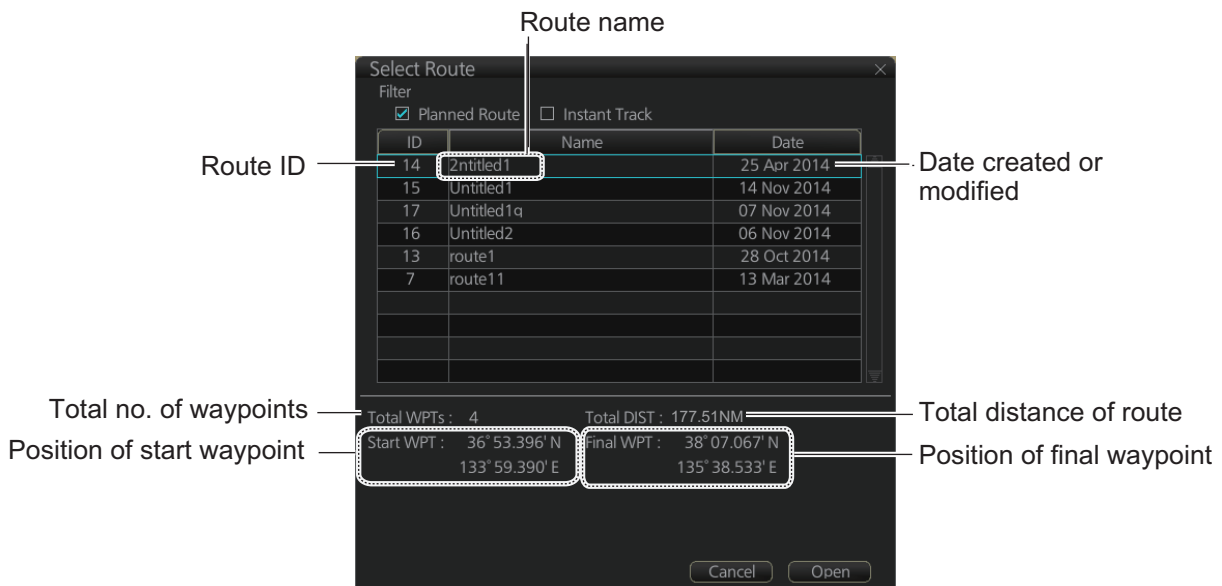

In the Voyage planning mode, the waypoints of a route can be inserted into the route currently selected.

- Show the dialog box shown above.

2. Select the route for which you want to copy its waypoint(s) in the active route. For example, select Route2. Click the [Open] button.

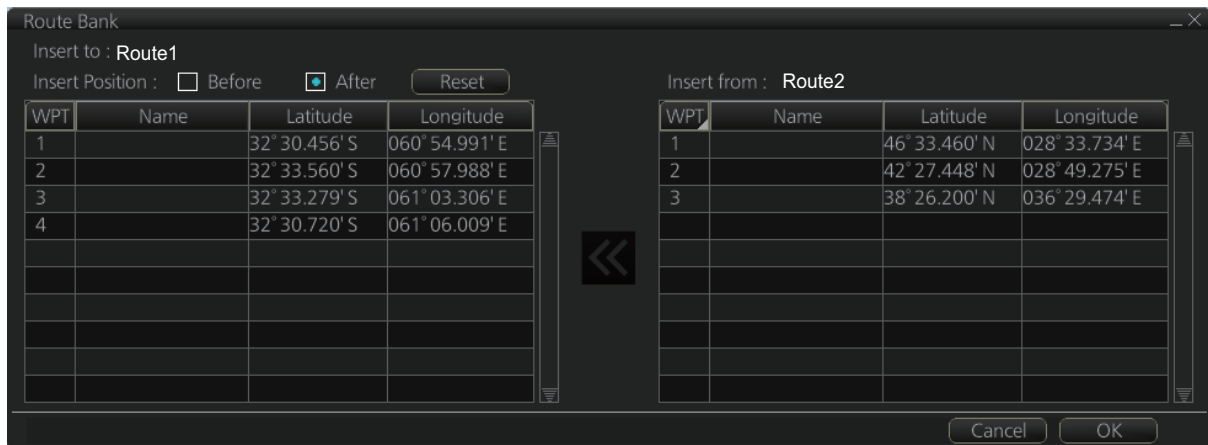

3. At [Insert Position], select where you want to insert waypoints into the active route, [Before] or [After] the waypoint selected in the next step. The [Reset] button restores the route to the original condition.
4. In the left-hand column set the cursor on the waypoint where to insert waypoints from the inactive route.
5. At the right-hand column, select the waypoint(s) to add to the active route. A context-sensitive menu is available by right-clicking [WPT] in the inactive route. The options available are [Select All], [Deselect All] and [Reverse] (reverse the order of the waypoints in the inactive route).
6. Click the << button to insert the waypoint(s) from the inactive route to the active route. In the example below, WPT1 of the inactive route is inserted at the end of the active route, becoming its waypoint 5.

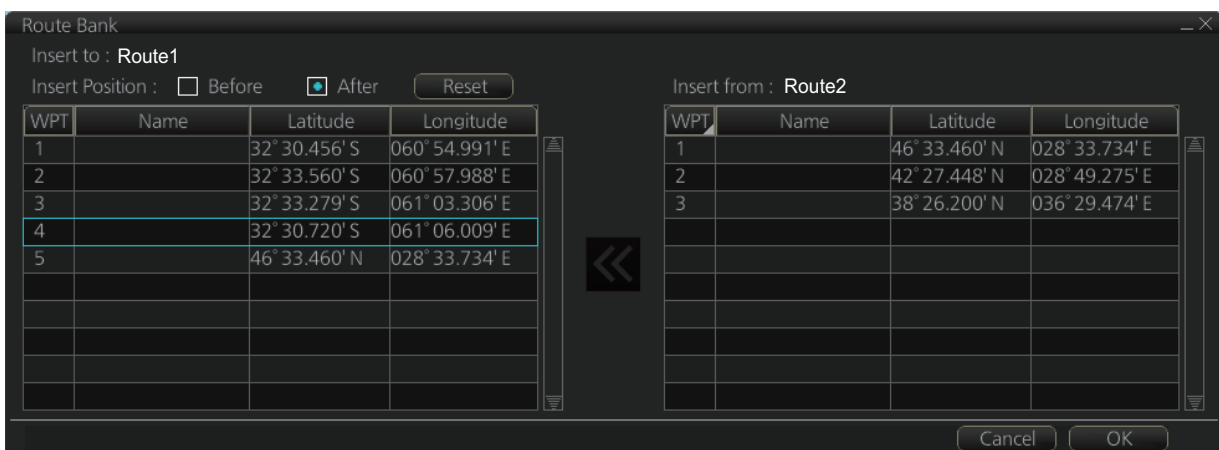

7. Click the [OK] button to finish.

9.8 Route Optimization

9.8.1 Available route optimization strategies

After all waypoints are inserted, the route is optimized from the [Optimize] page in the [Route Plan] dialog box. If no optimization strategy is chosen, the optimization is done with "max. speed," defined in ship parameters. Optimization calculates all parameters for route steering (course and distance between two waypoints, maneuvering start point, WOP, etc.). There are four methods for optimization:

Max speed: This calculation uses the maximum speed defined in the ship parameters and multiplies by all reduction factors (weather, ice, fouling, etc.) together with speed limits given for each waypoint to generate ETA. ETA may be entered, however it is calculated with user-entered ETD and speed limit.

Time table: Calculates the speed required in order to arrive at destination at required ETA. Maximum speed is never exceeded. The user enters ETD and ETA to calculate speed to use. If, the user-entered ETA is earlier than that found with the Max. Speed calculation, the Max. speed-calculated ETA will be indicated below the Time Table ETA calculation figure. The calculated speed is shown on the [Route Information] box as [Plan Speed].

Max. profit: Based on ETD, this calculation takes in account the fuel cost and the fixed cost of the ship and calculates the most profitable speed (highest profit per time unit).

Min. cost: Based on ETD, this calculation takes in account the fuel cost and the fixed cost of the ship and calculates the speed that gives the minimum total cost. You need to set Cost parameters beforehand to use this feature.

9.8.2 How to optimize a route

You can define Estimated Time of Departure (ETD), desired number of waypoints and Estimated Time of Arrival (ETA) on the [Optimize] page in the [Route Plan] dialog box to optimize your route.

1. Click the [Optimize] tab to open the [Optimize] page.



2. At [Type], click the drop-down list to select desired optimization strategy, referring to section 9.8.1 Available route optimization strategies.

3. Do the following:

- 1) At the [Set ETD] window, enter starting WPT and date and time of departure. For entry of the date, the [Set date] window, shown right, appears. Click the applicable date in the calendar if you are going to depart during the current month, or click the applicable arrow on the month/year button to select a different date. Click the [OK] button to save the ETD and close the window.

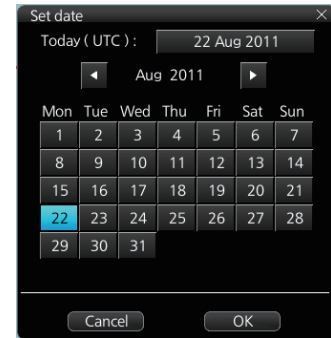

- 2) At the [Waypoints] page in the [Route Plan] dialog box, enter the maximum speed to use. For the Type [MAX profit], enter [Income] value. If necessary, click the [Edit Cost Parameters] button to enter fuel consumption values.



- 3) For [Time table], the [Set ETA] window appears. Set the ETA to use for each waypoint. To enter the Time and Date, click the [Date] window to show the [Set date] window. Click the appropriate date. The date entered appears in the [Set ETA] window.



4. Click the [Calculate] button to calculate optimal route. The [Optimized Speed/ETA] dialog box shows the results of the calculation.

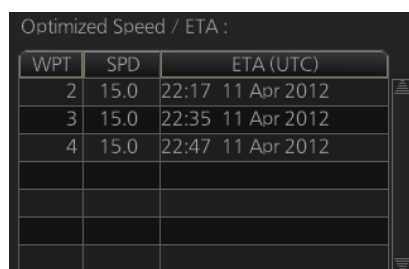

5. To apply the ETA results to the route, click the [Apply to Route] button.
6. To save all optimization settings, click the [Save] button.

Note that the ETA used in route reports is the first-entered ETA.

9.8.3 How to plan a speed profile

A speed profile is defined by general max. speed and optimization types. These values are given while planning a route. You can define speed limit and optimize type in the [Optimize] page of the [Route Plan] dialog box and in the [Waypoints] page you can give planned and max. speed for each leg. The table below demonstrate how different optimize types and speed limits influence speed.

WPT	min. cost	max. profit	timetable	Max speed
1	4.8	10.9	10.0	10
2	4.8	12.9	15.0	15
3	4.8	12.9	16.2	20
4	4.8	12.9	16.2	20
5	6.0	12.9	15.0	15
6	6.0	12.9	16.2	20
7	4.8	12.9	16.2	20
8	4.8	12.9	16.2	20
9	6.0	12.9	16.2	17
10	4.8	8.0	8.0	8

9.9 How to Import Routes

9.9.1 How to import route data from another unit

You can import a route created on another FMD-3xx0, FAR-3xx0, FCR-2xx9.

1. Set the USB flash memory that contains the route data to import in a USB port on the PCU.
2. Click the [] button on the Status bar and select [Settings]. Click the [OK] button then select [Settings].
3. Click the [File Import] tab.

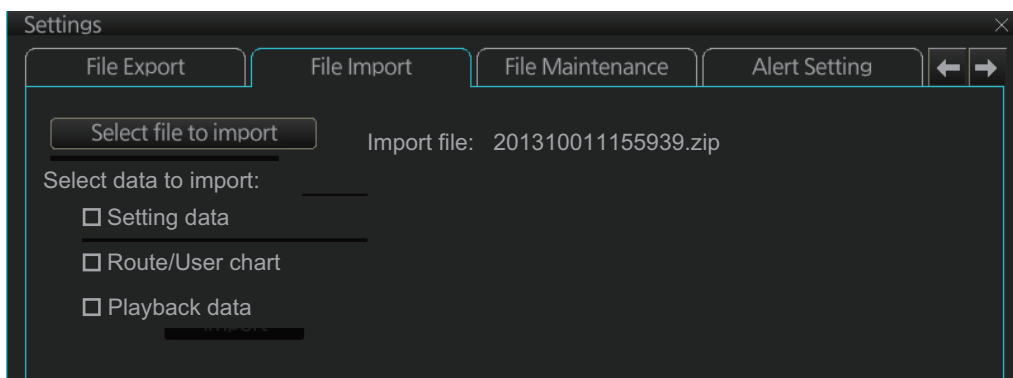

4. Click the [Select file to import] button to select the file to import. Click the [Open] button.
5. Check [Route/User chart].
6. Click the [Import] button.

9.9.2 How to import FEA-2x07 route data

Routes created at an ECDIS FEA-2x07 can easily be imported to this ECDIS. Copy the routes to a folder in a USB flash memory then follow this procedure. Note that FEA-2x05-created routes cannot be imported.

1. Set the USB flash memory to the USB port on the Control Unit.
2. Activate the Voyage planning mode.
3. Click the [Manage Data], [Data Import] and [Route] buttons to show the [SELECT DIRECTORY] dialog box.
4. Select the folder that contains the route(s) to be imported then click the [OK] button.
5. Check the route(s) to import then click the [Import] button.

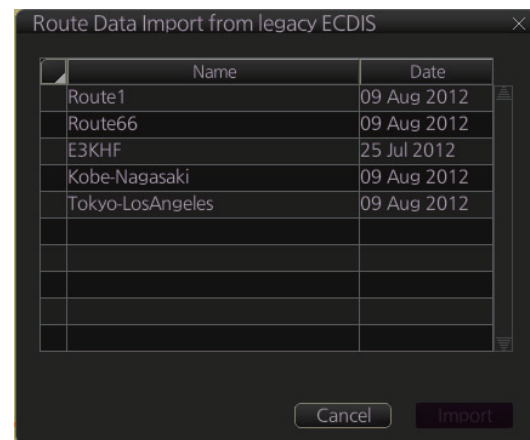

9.9.3 How to import RTZ, CSV, ASCII format route data

1. Set the USB flash memory to the USB port on the PCU.
2. Activate the Voyage planning mode.
3. On the InstantAccess bar™, click the [Manage Data] and [Route] buttons to show the [Route Data Management] dialog box.

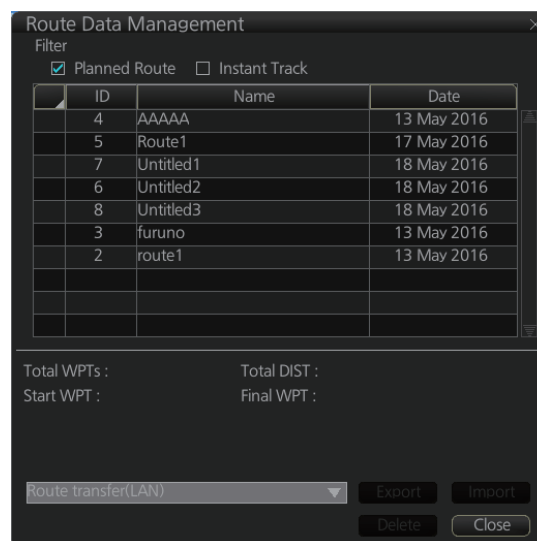

4. At the drop-down list, select the import format. The choices are
 - [RTZ]: route data, XML format
 - [FEA-2x07]: route data, ECDIS FEA-2x07 format
 - [CSV Position]: waypoint position data, CSV format
 - [ASCII WPT Name Position]: waypoint name, position order, ASCII format
 - [ASCII Full]: all route data, ASCII format
 - [ASCII Full (Support Asymmetrical XTD Limit)]: asymmetrical channel limit support, ASCII format
 - [CSV Route Sheet]: route data, CSV format
 - [RTE Format]: route data, RTE format

Note: Route Transfer (LAN) is shown an option when the route transfer function is on. However, at this time, it is no use.

5. Click the [Import] button.
6. Select the file to import then click the [Open] button.
7. Click the [Close] button to finish.

9.10 How to Export Route Data

9.10.1 How to export FMD-3xx0 route data

You can export route data to share the data with other FMD-3xx0 units.

1. Set a USB flash memory in a USB port on the PCU.
2. Click the  button on the Status bar and select [Settings]. Click the [OK] button then select [Settings].
3. Click the [File Export] tab.

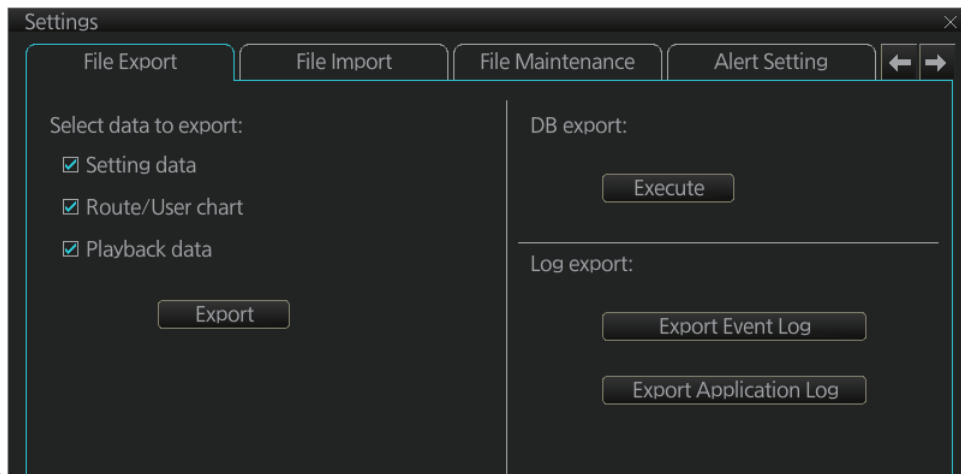

4. At [Select data to export], check only [Route/User chart].
5. Click the [Export] button to save the data to the USB flash memory.

9.10.2 How to export route data in FEA-2x07, RTZ, CSV, ASCII format

1. Activate the Voyage planning mode then set a USB flash memory to the USB port on the PCU.
2. On the InstantAccess bar™, click the [Route], [Route] and [Route Data Management] buttons to show the [Route Data Management] dialog box.
3. At the drop-down list, select the import format. The choices are
 [RTZ]: route data, XML format
 [CSV Position]: waypoint position data, CSV format
 [ASCII WPT Name Position]: waypoint name, position order, ASCII format
 [ASCII Full]: all route data, ASCII format
 [ASCII Full (Support Asymmetrical XTD Limit)]: Asymmetrical channel limit support, ASCII format
Note: Route Transfer (LAN) is shown an option when the route transfer function is on. However, at this time, it is no use.
4. Check the route(s) to export then click the [Export] button.
5. Click the [OK] button.

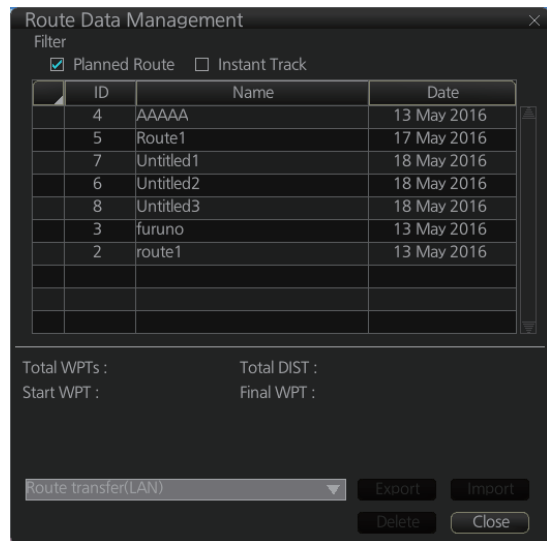

9.11 How to Delete Routes

1. Click the [PLAN] button on the Status bar to get into the Planning navigation mode.
2. Click the [Manage Data] button on the InstantAccess bar™ followed by the [Route] button.
3. Put a checkmark in the check box to the left of the route name.
4. Click the [Delete] button.
5. Click the [OK] button to delete the route(s) selected.

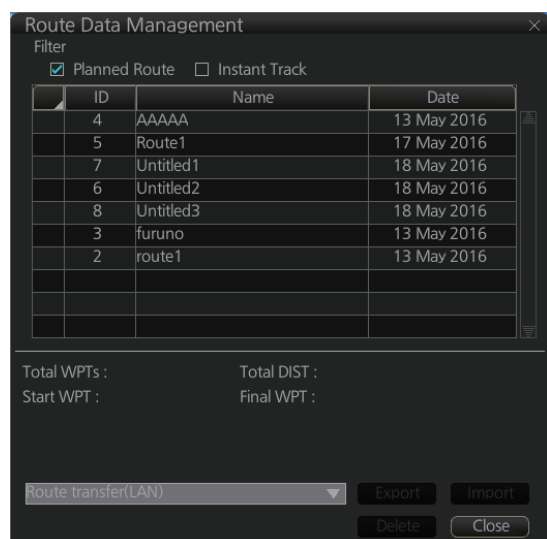

9.12 Route Transfer Feature

The route transfer feature lets you send and receive route data (RRT sentence) among the units connected in the LAN. Information about transmitted and received route data is stored in the route transfer log (see section 19.6).

Note: This feature is not available with our FAR-2xx7, FAR-2xx8 series radars. When you start monitoring a route, the route will be automatically sent to the radar connected in the network, regardless of the setting of this function.

9.12.1 How to turn route transfer on/off

To turn the route transfer feature on or off, do the following:

1. Open the menu, then click [Shared] and [Route Transfer] to show the following dialog box.

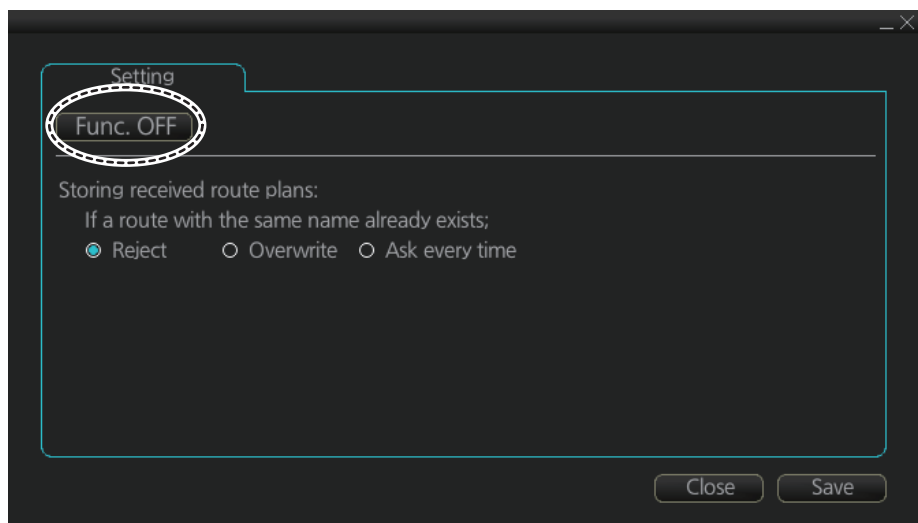

2. Click the function button (circled in the figure above) to change its label to read [Func. ON] (route transfer is enabled) or [Func. OFF] (route transfer is disabled) as required.

When route transfer is enabled, the following functions are also enabled:

- Send/receive monitored routes
- Send/receive planned routes

If you turned on route transfer, go to step 3. If you turned off route transfer, go to step 4.

3. Use the radio buttons to select what to do when receiving route data having the same name as existing route data - [Reject], [Overwrite], [Ask every time].
 - [Reject]: Don't save received route data. When route data is being received, a pop-up message informs you that the data will not be saved.
 - [Overwrite]: Previously existing route data is written over. No notification of the overwriting is given.
 - [Ask every time]: The [Route Transfer] dialog box appears. Click applicable button, referring to the description below.

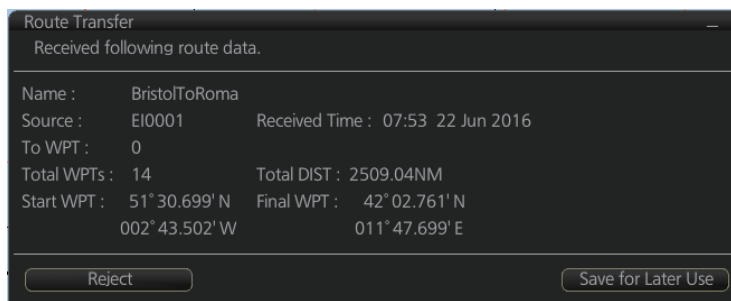

- [Reject]: Route data is not saved.
 - [Save for Later Use]: Route data is saved. (You can write over existing route data or save received route data under a new name.)
4. Click the [Save] button to save your settings, then click the [Close] button to finish and close the dialog box.
With route transfer selected to ON, the option [Route transfer (LAN)] is added to the drop down list box in the [Route Data Management] dialog box.

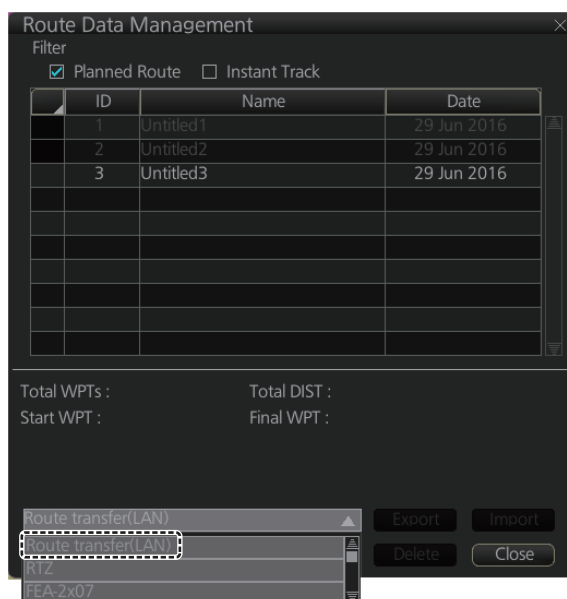

9.12.2 How to send and receive monitored routes

Sending monitored routes

The ECDIS sends the route data for a route which is selected for monitoring to other ECDIS connected to the same network. This is done automatically when route transfer is enabled and route monitoring is initiated.

Receiving monitored routes

When a route is received from another ECDIS on the same network, the [Route Transfer] window appears.

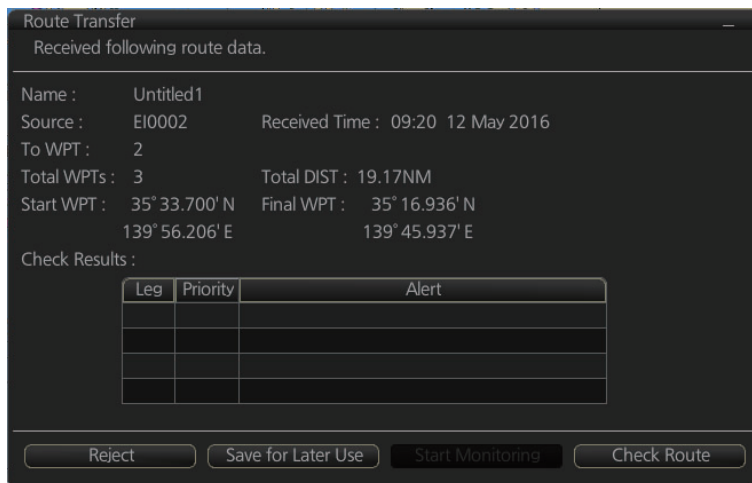

Select the appropriate handling for the received route from the buttons at the base of the [Route Transfer] window.

- [Reject]: Route data is not saved.
- [Save for Later Use]: Route data is saved. (You can write over existing route data or save received route data under a new name.)
- [Start Monitoring]: Moves the received route to the Route Monitor. This button is not selectable until the route is checked.
- [Check Route]: Check route for safe navigation. The results are shown the [Check Results] page. After the check is complete, the [Start Monitoring] button becomes selectable.

9.12.3 How to send and receive planned routes

Sending a planned route

You can send a planned route to other ECDIS in the same network.

1. Click the [PLAN] button on the Status bar to get into the Voyage planning mode.
2. On the InstantAccess bar™, click the [Manage Data] and [Route] buttons to show the [Route Data Management] dialog box.
3. Place a check in the box to left of the route(s) to transfer, then select Route transfer (LAN) from the drop-down box.
4. Select [Export].
The selected route(s) are transferred to the ECDIS connected to the same network.

Note: If route transfer fails, the message "No response of route transfer. Please try again route transfer." appears. Check connections, then retry the above procedure.

Receiving a planned route

When a planned route is received with same name as an existing route, it is handled in the manner set at step 3 of section 9.12.1.

For all other received routes, the system automatically saves the route.

9.13 Reports

This ECDIS generates reports for waypoints in the selected route. If connected to a printer, reports can be printed by clicking the [Print Text] button. Text in reports can be searched with the [Find] button.

To generate a report, do the following:

1. Click the [PLAN] button to go to the Voyage planning mode.
2. Click the [Report] button followed by the [Route] button. Click applicable “report” button - [WPT], [Full WPT] or [Passage].

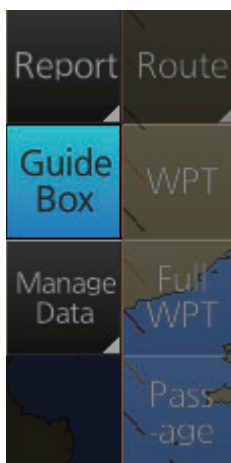

The following dialog box appears.

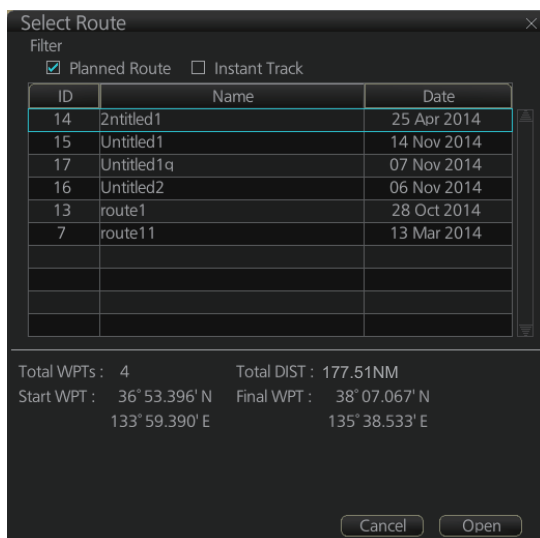

3. Select the appropriate route then click the [Open] button to show the selected report. See the next several pages for examples.

9. ROUTES

WPT report

The WPT report contains the following information for each waypoint in the route selected.

- Route name
- Date of report
- Waypoint no.
- Position in latitude and longitude
- Length of waypoint
- Distance remaining in route
- Planned courses and steering methods (RL (RhumbLine), GC (GreatCircle))
- Turning radius
- Planned speeds
- Estimated times of arrival (ETA)
- ETD from waypoint 1 (start point)
- ETA to waypoint "x" (final waypoint)
- Total length of route
- Estimated time required to run route using planned speeds and courses



Route Planning Report

Route Name : FEA-ROUTE-WPTNAME-FINLAND
Report Date : 02:41 23 Apr 2013

WPT	Name	HFO	DO	LAT	LON	Length	Remain	CRS	M	RAD	SPD	ETA
1 "A	"			34° 41.169'N	135° 19.531'E	(N/A)		37.0	(N/A)	(N/A)	(N/A)	(N/A)
2 "A	"			34° 35.408'N	135° 19.468'E	5.8		31.3	180.5	RL	0.80	22.0
3 "O	"			34° 34.995'N	135° 15.729'E	3.1		28.1	262.4	RL	0.80	22.0
4 "AO	"			34° 34.761'N	135° 09.423'E	5.2		22.9	267.4	RL	0.80	22.0

Full WPT report

You can generate a full waypoint report for the route selected. The report includes the following for each waypoint

- Route name
- Date of report
- Waypoint no.
- Position in latitude and longitude
- Planned radius
- XTD limit
- Planned speed
- Planned course
- ETA
- Steering mode (rhumb line or great circle) to each waypoint
- ROT
- Margin for XTD limit
- Speed Max
- Leg length
- Time used

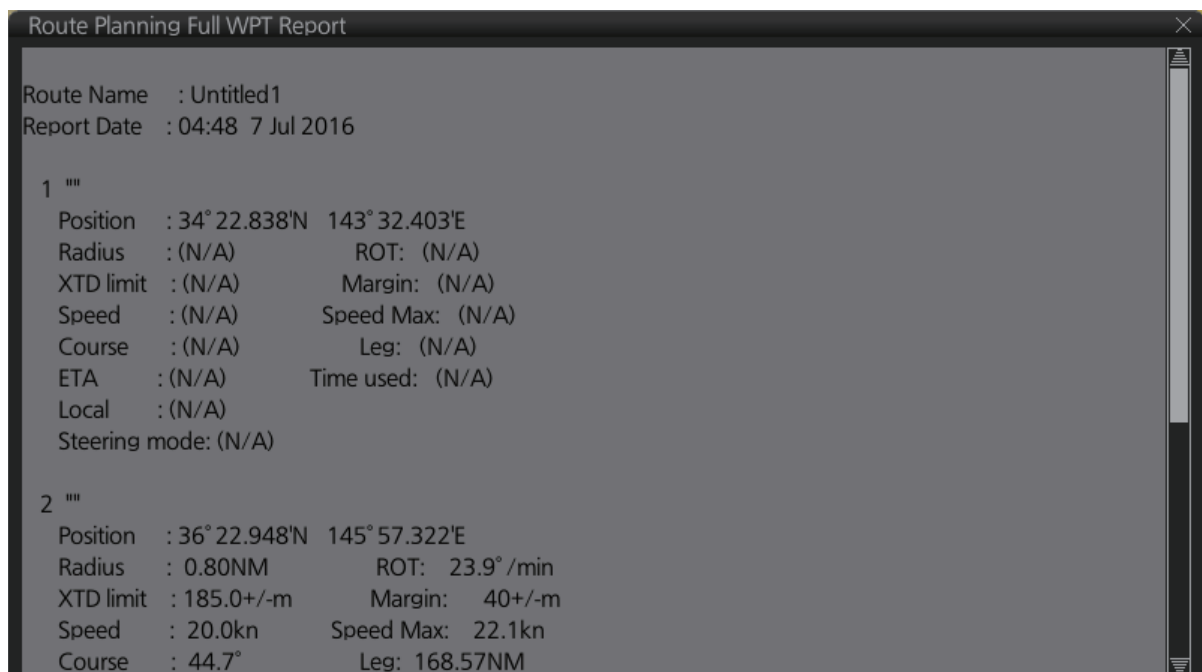

9. ROUTES

Passage plan report

The passage plan report generates waypoint information for each waypoint in the route selected.

- Route name
- Date of report
- Waypoint no.
- Position in latitude and longitude
- Length
- Cumulative length
- Planned course
- Steering method (RL or GC)
- Name of waypoint



Route Passage Plan Report

Route Name : FEA-ROUTE-WPTNAME-FINLAND
Report Date : 02:42 23 Apr 2013

WPT	LAT	LON	Length	Cumul.	CRS	M	Name
1	34° 41.169'N	135° 19.531'E	(N/A)	(N/A)	(N/A)	(N/A)	"A "
2	34° 35.408'N	135° 19.468'E	5.8	5.8	180.5	RL	"A "
3	34° 34.995'N	135° 15.729'E	3.1	8.9	262.4	RL	"O "
4	34° 34.761'N	135° 09.423'E	5.2	14.1	267.4	RL	"AO "
5	34° 28.819'N	135° 08.166'E	6.0	20.1	189.9	RL	"OA "
6	34° 25.383'N	135° 01.630'E	6.4	26.5	237.6	RL	"AA "
7	34° 14.947'N	134° 59.995'E	10.5	37.0	187.4	RL	"AAO "

10. USER CHARTS

10.1 Introduction

User charts are overlays that the user creates to indicate safety-related objects and areas. They can be displayed on both the radar overlay and the electronic chart. These charts are intended for pointing out safety-related items like position of important navigation marks, safe area for the ship, etc. User charts areas can be used to activate alerts and indications based on user-defined danger symbols, lines and areas. When route or own ship estimated position is going to cross a user chart symbol, line or area that is defined as a dangerous one, an alert or indication is generated by the system. See the chapter on chart alerts.

A user chart consists of various objects (points, lines, text, symbols, etc.). The maximum number of objects per user chart is 300. A route may have up to five user charts, for a max. of 1,500 user chart objects per route.

The user chart is displayed on the radar overlay and its position and shape is based on the ship's actual position. When own ship is moving in the area covered by the user chart, the elements of the user chart are superimposed on the radar, with a maximum of 80 of the nearest elements displayed.

Note: If more than 200 user charts are linked to a route and the route data is transferred to a unit using software version is 3.02 or older, only the first 200 chart objects are displayed.

10.1.1 Objects of user charts

Below is a description of the objects used in a user chart.

- **Tidal:** There are two types of tidals, current and predicted.
- **Line:** You can define four different types of lines. Lines can be used in chart alert calculation and/or display on the radar:
 - **Navigation lines:** Displayed on both the radar overlay and the ECDIS display. Navigation lines are reference lines for coast line.
 - **Coast line:** Displayed on both the ECDIS and radar overlays. Coastal line is usually a well-defined (by chart digitizer) multi-segment line showing the coastline. The user is able to create this type of line in case there is no suitable chart available over desired area in S57 format.
 - **Depth contour:** Displayed on both the ECDIS and radar overlay. Depth line shows the chosen depth levels. The user is able to create this type of line in case there is no suitable chart available over desired area in S57 format.
 - **Route line:** Displayed on both the radar overlay and the ECDIS display. Route lines are zones for anchoring, traffic separation lines, etc.
- **Clearing line:** A clearing line is used to define a line which a vessel can sail to avoid navigational hazards. A clearing line can be of the NMT (Not More Than) or NLT (Not Less Than) type. Displayed on the ECDIS display only.
- **Area:** The operator can define closed areas, which the system can use to detect safe water areas. If route or estimated ship position is going to cross the area, the

system generates a warning to the user. These areas can be used to specify safe areas as defined by the master or by the policy of the ship's owner. They are always available regardless of the type of chart material used.

- **Circle:** The operator can define an area with a circle, which can define a location to avoid. If route or estimated ship position is going to cross the area, the system generates a warning to the user. These areas can be used to specify safe areas as defined by the master or by the policy of the ship's owner. They are always available regardless of the type of chart material used.
- **Labels:** There are two types of labels: point and label. A "point" (i) is mainly used to denote position of objects, such as buoys, light houses, fixed targets, wrecks, etc. Points can be used in chart alert calculation. A "label" provides user-entered text to show on the display.

10.2 How User Charts are Synced

User chart data can be shared between this ECDIS and other like units (FMD-3x00, FCR-2xx9, FAR-3xx), through the LAN. A minimum of two units is required. Turn on all units beforehand to enable syncing. The sync source (master unit) is automatically assigned by the system when each unit is powered. For configurations with three or more units, two units are assigned as a sync source and have priority regardless of their power status (ON or OFF). The priority is assigned as follows:

- 1) ECDIS unit assigned as the Planning ECDIS.
- 2) ECDIS unit assigned with the lowest unit number at installation.
- 3) Chart Radar unit assigned with the lowest unit number at installation.

Be aware that if a unit is turned off, some user chart data may be deleted. Two examples are shown below.

Using ECD001 and ECD002

This example assumes that ECD002 is assigned as a Planning ECDIS.

1. ECD002 is off; ECD001 is powered and a user chart is created at ECD001. Even though ECD002 is the Planning ECDIS, user chart data is not transferred to ECD002 because the power is turned off.
2. ECD002 is turned on. As this unit is assigned as a Planning ECDIS, ECD001's user chart data is deleted.

Using ECD001, ECD002 and CRA001

This example assumes that ECD001 and ECD002 is assigned as a Planning ECDIS.

1. ECD001/002 are both turned off; CRA001 is powered and a user chart is created on CRA001. User chart data is not transferred as both ECD001 and ECD002 are turned off.
2. ECD001 is turned on. As this unit is assigned as a Planning ECDIS, CRA001's user chart data is deleted.

If the operator clicks the PLAN button on the Status bar when one or more units (including the master unit) is turned off, one of the following messages appears. Turn all units in the same network on, then plan or edit the route as required.

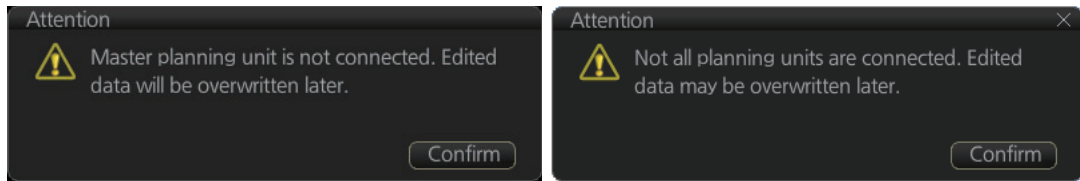

10.3 How to Create a User Chart

You can create and modify a user chart in the Voyage planning mode.

To make a complete user chart, do the following:

1. Click the [PLAN] button on the Status bar to go to the Voyage planning mode.
2. Click the [Planning] and [User Chart] buttons on the InstantAccess bar™ to show the user chart palette and the [User Chart] dialog box.
3. Click the [New] button on the [User Chart] dialog box to create a new chart.

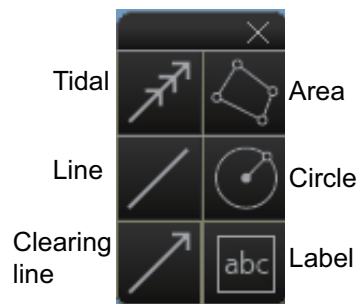
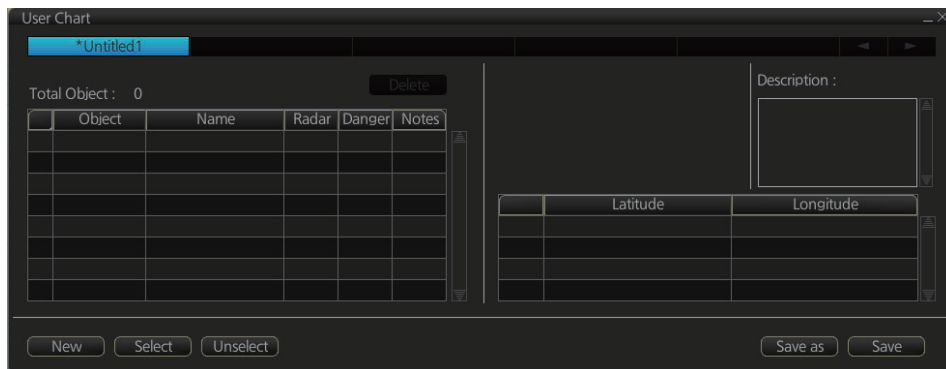

4. Click the desired object (button) on the palette. The [Tidal], [Line], [Clearing line] and [Label] buttons have multiple choices. Right-click the respective button to show a context sensitive menu. The choices available for each object are shown below.

Tidal: Current, Predicted

Line: Coast, Nav, Route, Depth

Clearing line: NMT (Not More Than), NLT (Not Less Than)

Label: Point, Label

5. Put the cursor on the location to insert the object then push the left button. See the figure below for how to construct lines, areas and circles. For the "Tidal" ob-

10. USER CHARTS

ject, you can set Orientation, Strength and Time from the dialog box. With the "Label" object you can enter text and show that text on the screen.

Note: An object can also be put at the center of the screen. Do step 1-4 in this procedure. On the [User Chart] dialog box, right click the box to the left of [Object] then select [Add Object] from the pop-up menu.

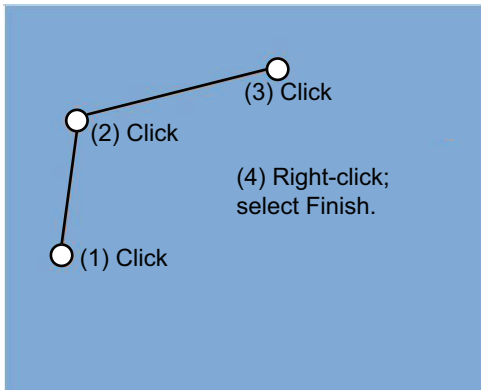

How to create a line

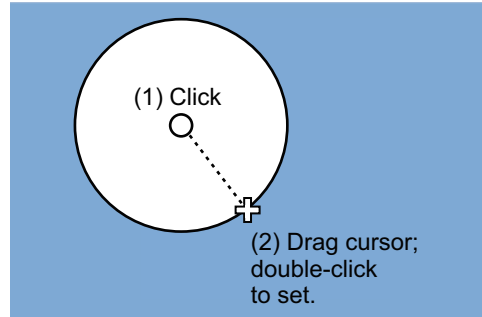

- 1) Put cursor where to locate center of circle then click.
- 2) Drag cursor to set radius; double-click to set.

How to create a circle

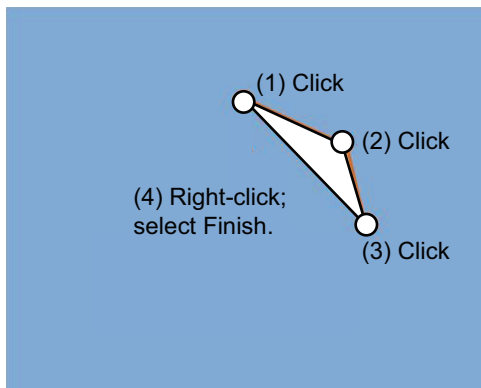

How to create an area

When you insert an object, the following is done in the [User Chart] dialog box:

- Name of the object button appears in the [Object] window
- Latitude and longitude position of the object is displayed
- Total object count is updated

6. To enter a name for the object, click the appropriate location in the [Name] window then use the software keyboard to enter a name.

Note: The name entered for circles and areas can be shown inside the area or circle on the screen. For details, see subsection 4.3.4.

7. **Label, line, clearing line, area, circle:** Click the corresponding box in the [Radar] column to hide or show the checkmark to display or don't display the object on the radar overlay.

Note: The clearing line setting is fixed to ON. (The checkmark is grayed out.)

8. **Label, line, clearing line, area, circle:** Click the corresponding box in the [Danger] window to hide or show the checkmark to use or don't use the object in chart alert calculation. For the tidal mark, go to step 9.

9. **Line, area, circle:** Do as shown below to add Notes data. For other objects go to step 10.

- 1) Enter the text for the Notes in the [Description] box.

- 2) Click the box in the [Notes] window of the [User Chart] dialog box to set the message display method.
 - E: Message appears when your ship approaches the user chart object. For a line, message appears when you are "x" miles from the line, which is set with [Range of notes].
 - P: Message appears when your ship is 10NM beyond the user chart object.
 - Blank: No message display.
- 3) At the [Range of notes] input box, enter the distance from the line position at which to display the Notes.

Note: You cannot select both Danger and Notes for these symbols; select either Danger or Notes.

What are Notes?

"Notes" provide, in the Voyage navigation mode, messages for the operator relative to your vessel's position. When own ship is x miles from an area or circle chart object, a message appears in the [Monitor Note] dialog box. The message appears for a line (set in [Range of notes]) when own ship is within x miles of the line or x miles after passing the line.

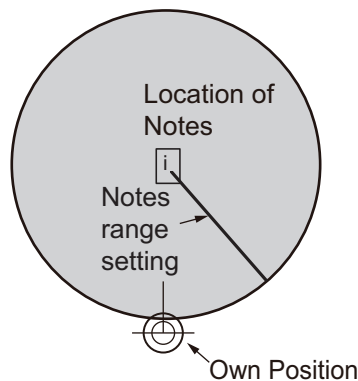

Own Position

The pop-up window at right appears when own ship approaches a user chart object within the range set. Example shown for "E" setting (approaching object).

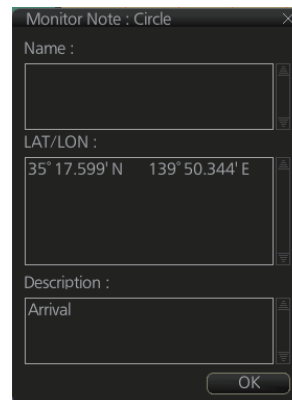

Note for Circle

10. To continue entering the same symbol, click a new location on the screen and do step 5. To enter a different symbol, do steps 4 and 5.
11. After you have entered all necessary objects, click the [Save] button.

Note: If the [Save] button is not shown, update the user chart to show the button.
12. The [Save as user chart window] appears. Enter a name for the user chart then click the [Save] button.

The figure on the next page shows a user chart and the corresponding entries in the [User Chart] dialog box.

10. USER CHARTS

- The Line with the name "Coast" is a coastline.
- The Circle has the Notes "Arrival No.1," which means the message "Arrival No.1" will be shown on the screen when the ship is 1 NM from the position of the center of the circle.
- The Tidal marks line marks a tidal (current).
- The Area has Radar and Danger checked. This means the area is shown on the radar overlay and is used in chart alert calculation.
- The Label with the name "Point No. 1" is a point label and is also shown on the radar overlay.
- The Label with the name "Wreck" is a common label and has Danger checked; it is used in chart alert calculation.

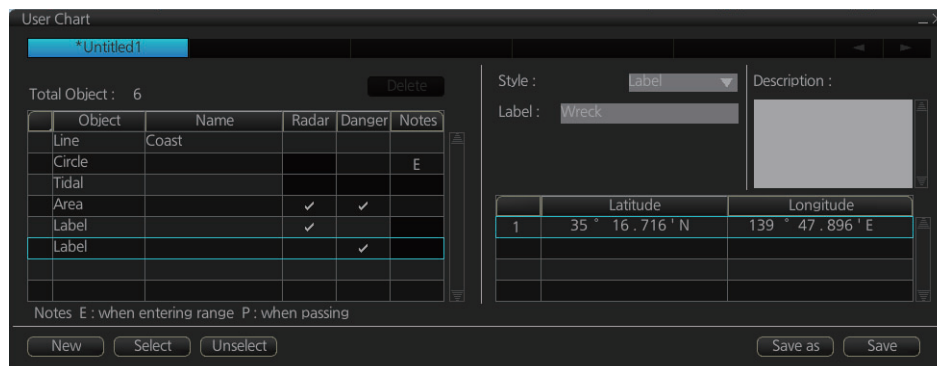
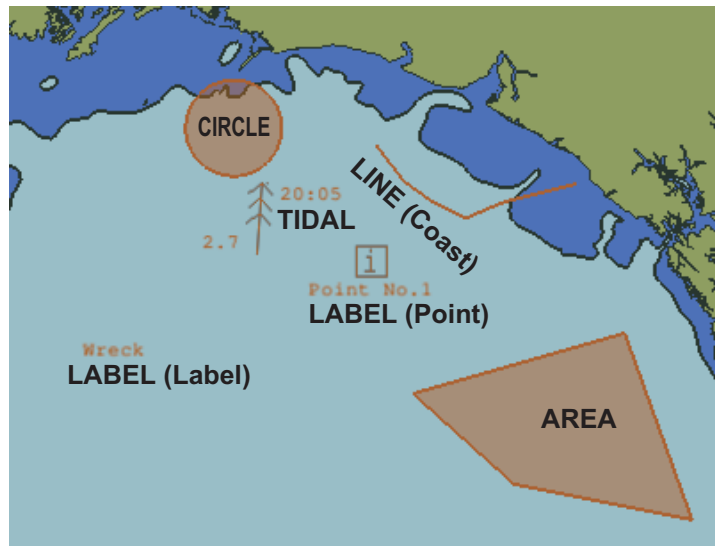

How to use the Undo feature

The Undo feature, available when creating a route and a user chart, can be accessed from the [Undo] button on the InstantAccess bar™, use double-click, or the context-sensitive menu. In user chart creation the feature is used with object and text input as follows:

Tidal, Circle, Current, Label: Delete last-entered object.

Area, Line: Erase last-entered point. For [Area], the area must have at least four points. And for a [Line], there must be at least three points.

Text input: Erase last-entered character or character string.

10.4 How to Edit Objects on a User Chart

1. Do steps 1 and 2 in section 10.3 to show the [User Chart] dialog box.
2. Click the [Select] button to show the [Select User Chart] dialog box.
3. Select the user chart to edit then click the [OK] button.
4. Edit the name, latitude and longitude of objects as required. Objects can also be edited in the chart area.

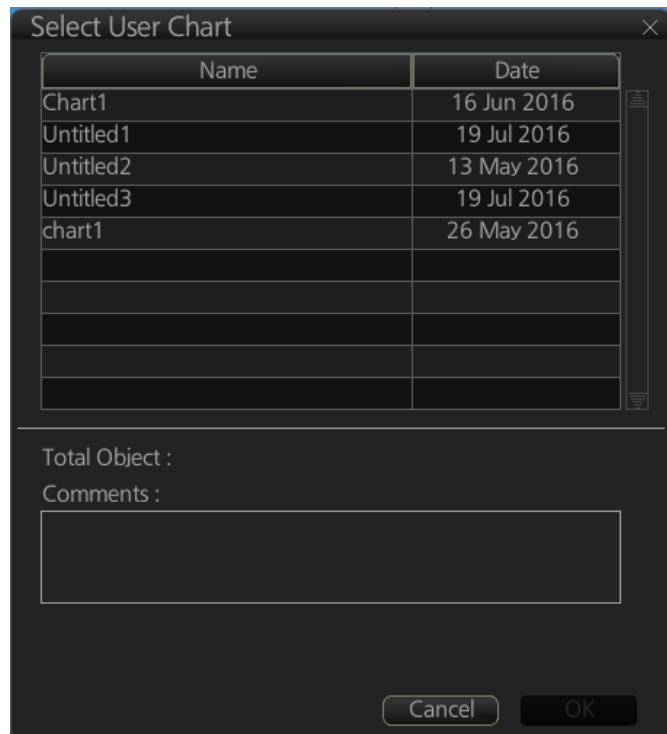

How to move objects

Drag and drop the object.

How to change corner points in lines and areas

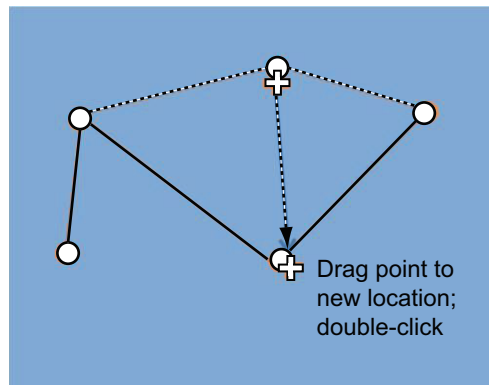

How to change corner point on a line

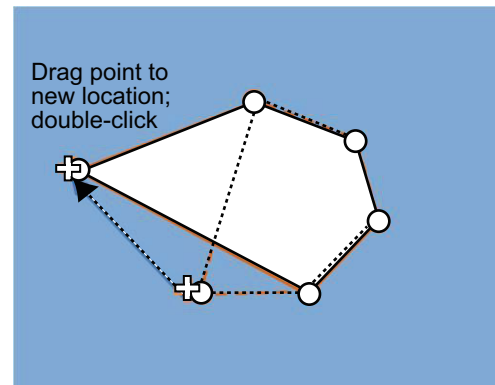

How to change corner point in an area

How to erase a corner point in an area

Right click the point to erase to show the context-sensitive menu. Select [Delete Point]. The object is redrawn to reflect new shape.

How to insert a corner point on a line or area

Put the cursor on the location where to insert a corner point, right-click the display area to show the context-sensitive menu then select [Insert].

Note: A point can also be inserted from the [User Chart] dialog box.

- 1) Open the [User Chart] dialog box and select a line or area.
- 2) At the position window at the right side, right click the location where to insert a point to show the context-sensitive menu.

- 3) Select [Insert Before] or [Insert After] to insert the point before or after the selected point.
- 4) Change latitude and longitude position of new point if necessary.
5. Click the [Save] button to save, then click the [Close] button to close the dialog box.

10.5 How to Delete Objects from a User Chart

1. Do steps 1 and 2 in section 10.3 to show the [User Chart] dialog box.
2. Click the [Select] button to open the [Select User Chart] dialog box.
3. Select the user chart that contains the object to delete, then click the [OK] button.
4. To the left of the [Object] column, put a check mark next to the item to delete.
5. Click the [Delete] button.
Note: An object can also be deleted from the chart area. Right click the object to delete, select [Delete] from the context-sensitive menu.
6. Click the [Save] button to save your edits and close the dialog box.

10.6 How to Copy a User Chart Object

You can copy a user chart object and add it to another user chart.

1. Do steps 1 and 2 in section 10.3 to show the [User Chart] dialog box.
2. Click the [Select] button to open the [User Chart Selection] dialog box.
3. Select the user chart to use, then click the [OK] button.
4. Follow steps 1-3 to select the chart where to copy the object.
5. Click the tab of the source user chart.
6. To the left of the [Object] column, put a check mark next to the item to copy.
7. Click the [Copy] button.
8. Click the tab of the user chart where to copy the object.
9. Click the [Paste] button.
10. Click the [Save] button to finish and close the dialog box.

10.7 How to Select the User Chart Objects to Display

User charts can be displayed on the electronic chart. On the InstantAccess bar™, click [DISP], [SET], and [Symbol DISP]. Open the [Mariner] page and check the user chart items to display. Choose the degree of transparency for the objects with [Density].

Note: Alpha blending technology is used for transparency effects.

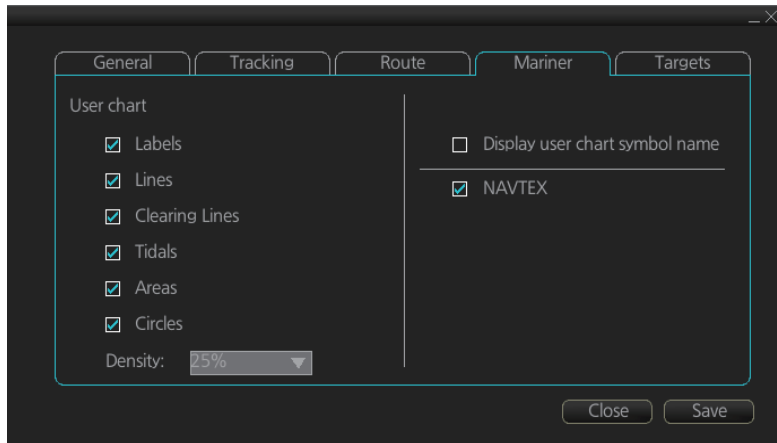

10.8 How to Import a User Chart

10.8.1 User chart created on another unit

Do as follows to import user charts created on other units (FMD-3x00, FCR-2xx9, FAR-3xx0).

1. Copy the user chart to a USB flash memory then insert the flash memory in the USB port on the PCU.
2. Click the Settings button () on the Status bar then select [Settings].
3. Click the [OK] button to open the [Settings] menu.
4. Click the [File Import] tab.

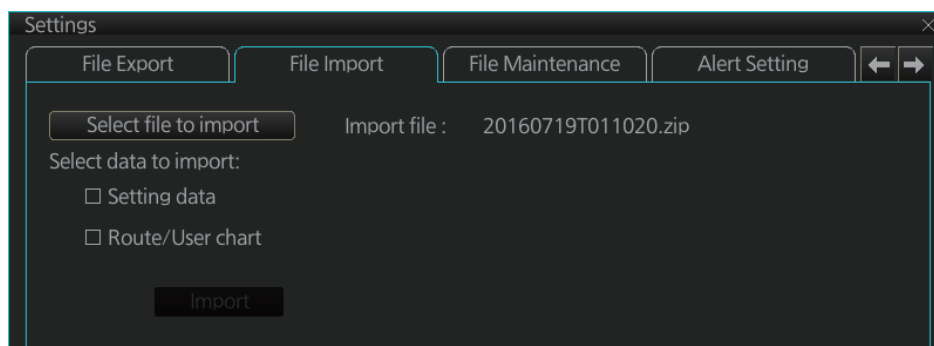

5. Put a checkmark at [Route/User chart].
6. Click the [Import] button.

10.8.2 User chart created with ECDIS FEA-2x07

User charts created at the ECDIS FEA-2x07 can easily be imported to this ECDIS. Copy the user charts to a folder (see chapter 17 in the operator's manual of the FEA-2x07) in a USB flash memory then do as follows. Note that FEA-2x05 created user charts cannot be imported.

1. Set the USB flash memory to the USB port on the Control Unit.
2. Activate the Voyage planning mode.
3. On the InstantAccess bar™, click the [Manage Data], [Data Import] and [User Chart] buttons to display the dialog box shown right.
4. Select the folder that contains the user chart(s) to be imported then click the [OK] button.
5. Check the user chart(s) to import.
6. Click the [Import] button.

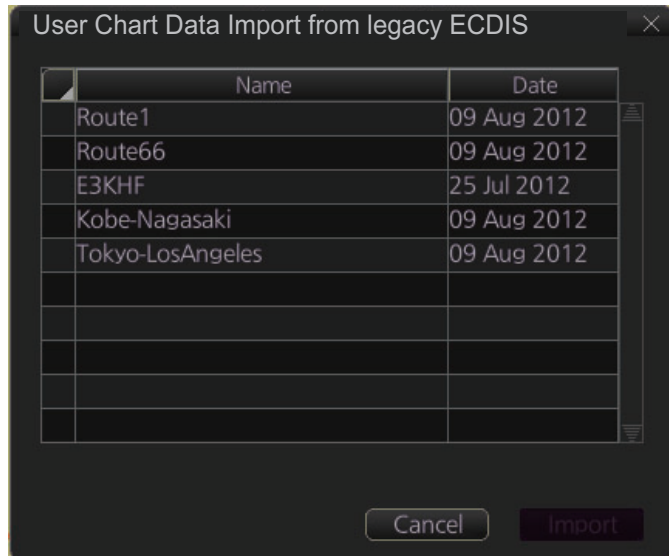

10.8.3 RTZ format user chart

1. Set the USB flash memory to the USB port on the Control Unit.
2. Activate the Voyage planning mode.
3. On the InstantAccess bar™, click the [Manage Data], [Data Import] and [User Chart] buttons to display the dialog box shown right.
4. Click the [Import] button.
5. Check the user chart(s) to import.
6. Click the [Close] button.

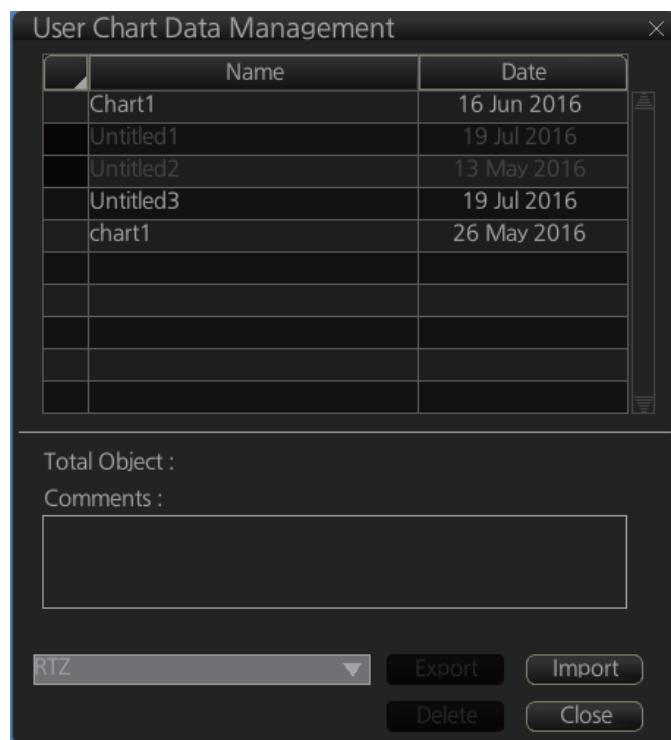

10.9 How to Export a User Chart

10.9.1 User chart created on FMD-3x00

Do as follows to import user charts created on other units (FMD-3x00, FCR-2xx9, FAR-3xx0).

1. Insert a USB flash memory in the USB port on the PSU.
2. Click [] on the Status bar, then click [Settings].
3. Click the [OK] button to open the [Settings] menu.
4. Click the [File Export] tab.
5. Put a checkmark at [Route/User chart].

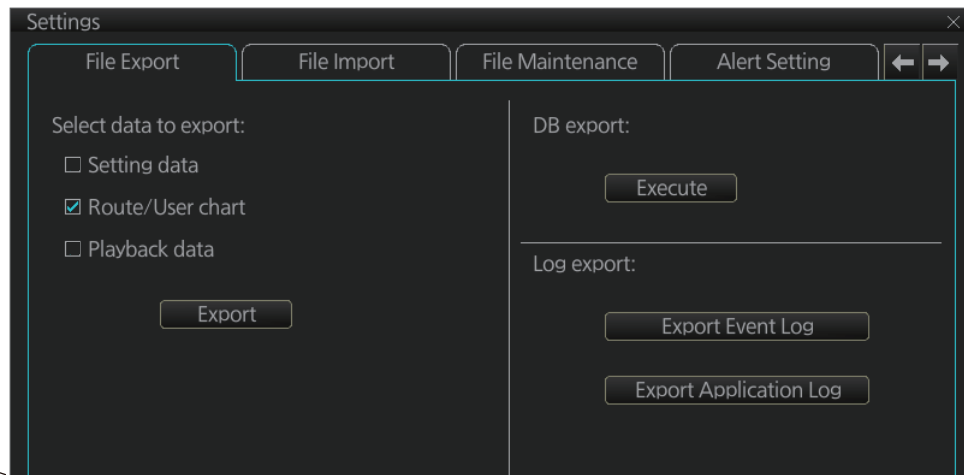

6. Click the [Export] button to export the data to the USB flash memory

10.9.2 RTZ format user chart

1. Set the USB flash memory to the USB port on the PSU.
2. Activate the Voyage planning mode.
3. Click the [Manage Data], [Data Import] and [User Chart] buttons on the InstantAccess bar™.
4. Click the [Export] button.
5. Check the user chart(s) to export.
6. Click where to export the data then click the [OK] button.

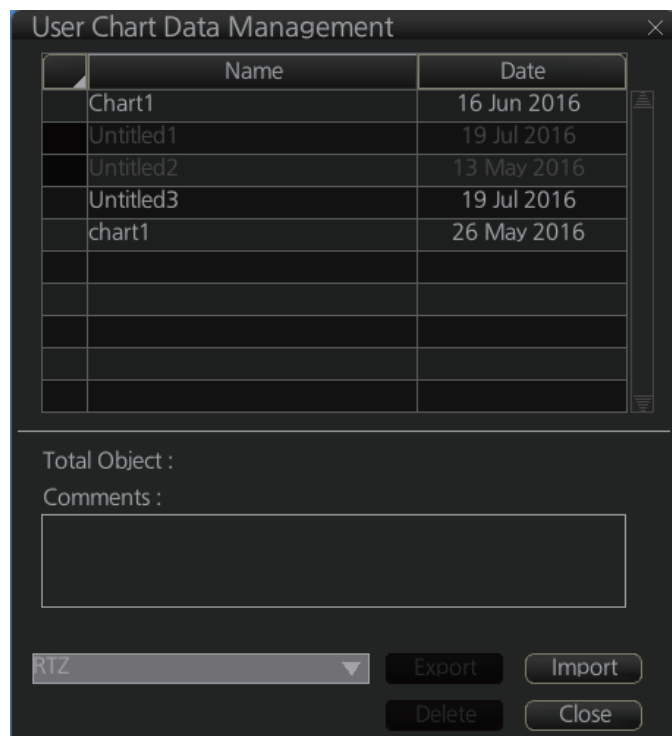

10.10 How to Delete User Charts

1. Click the [PLAN] button on the Status bar to get into the Planning navigation mode.
2. Click the [Manage Data] button on the InstantAccess bar™ followed by the [User Chart] button.

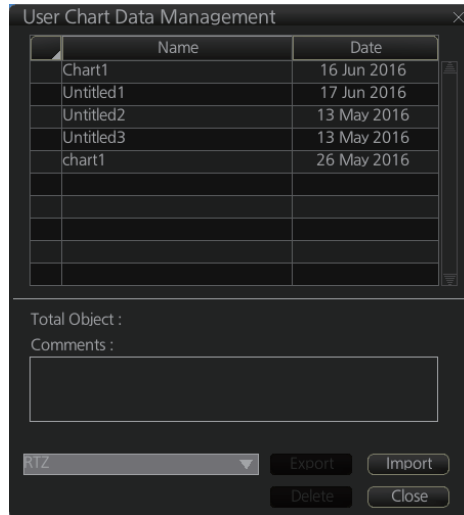

3. Check the user chart(s) to delete.
4. Click the [Delete] button then click the [OK] button.

10.11 User Chart Reports

1. Click the [Plan] button to go to the Voyage planning mode.
2. Click the [Report] button followed by the [User Chart] button to show the [Select User Chart] dialog box.

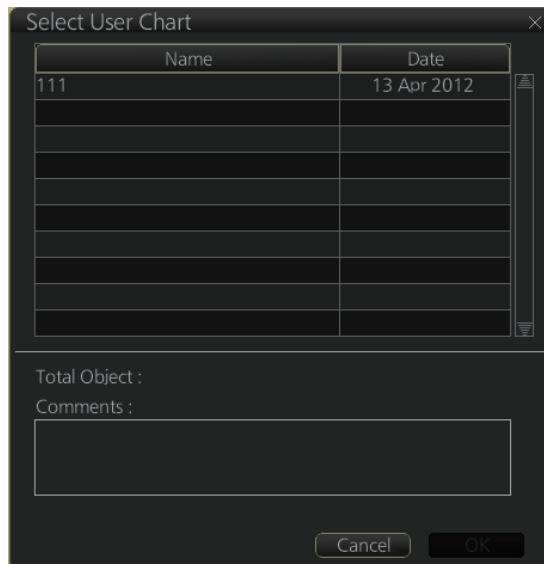

3. Select the appropriate user chart then click the [OK] button to show the selected report. See the next several pages for examples of reports.

Full report

The full report contains information about each tidal, line, clearing line, label, area and circle in the user chart selected. Check or uncheck the boxes at the top of the display to select the report(s) to display.

Check the report(s) to display.

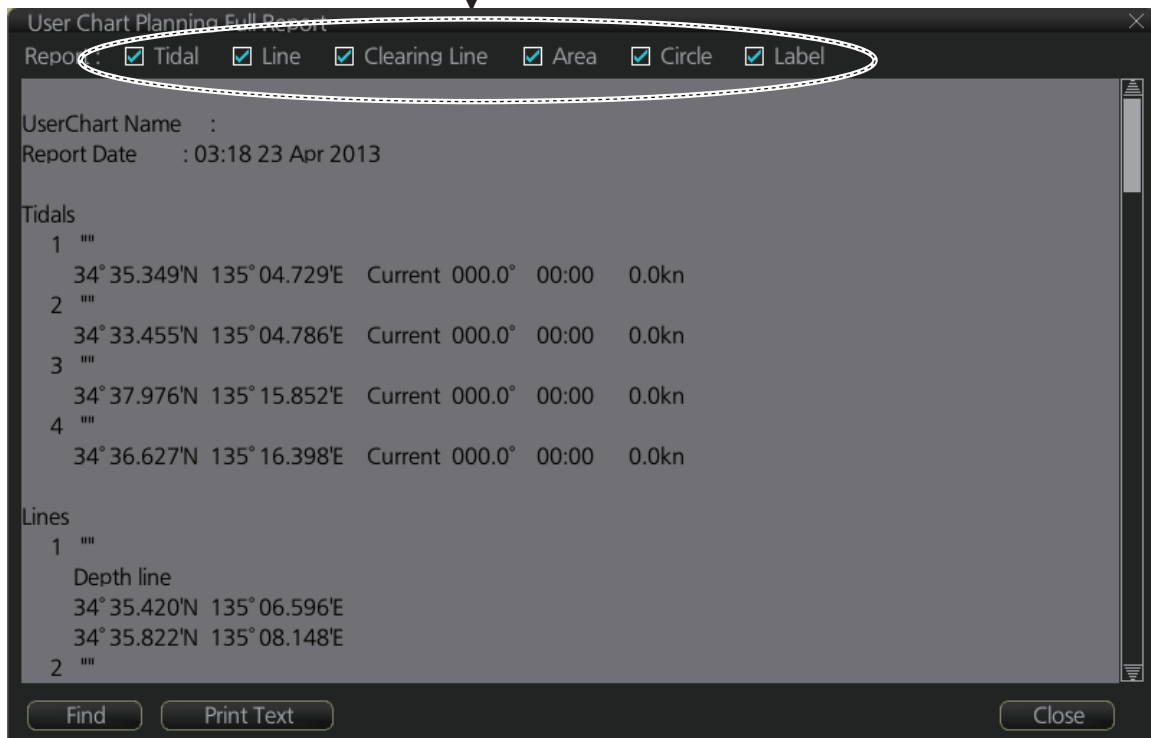

Tidal report

The tidal report provides

- Position of the tidal
- Type of tidal (current or predicted)
- Speed and direction of the tidal
- Time of the tidal

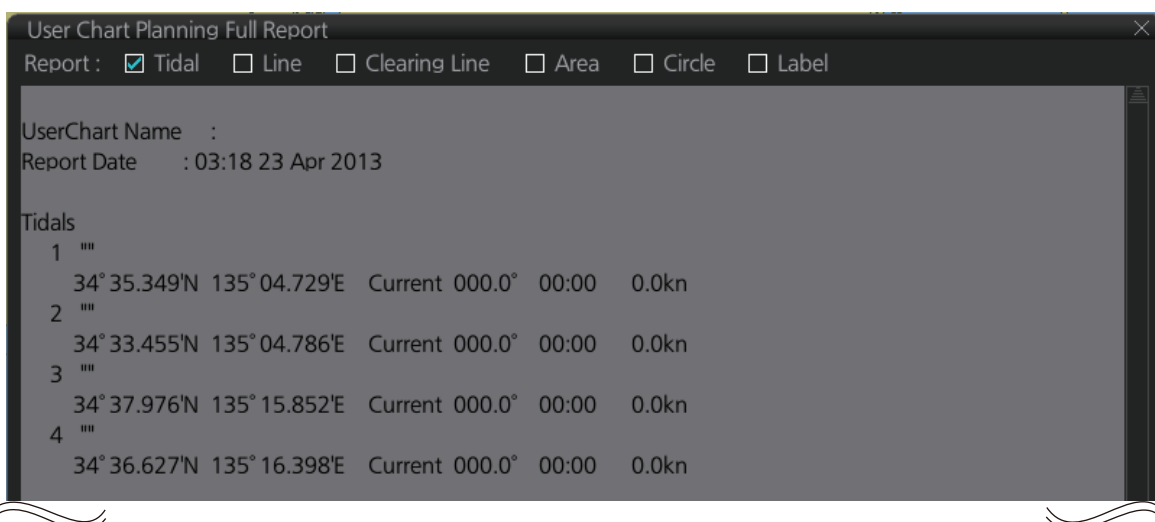

Line report

The Line report provides line name and latitude and longitude of each point on the line.

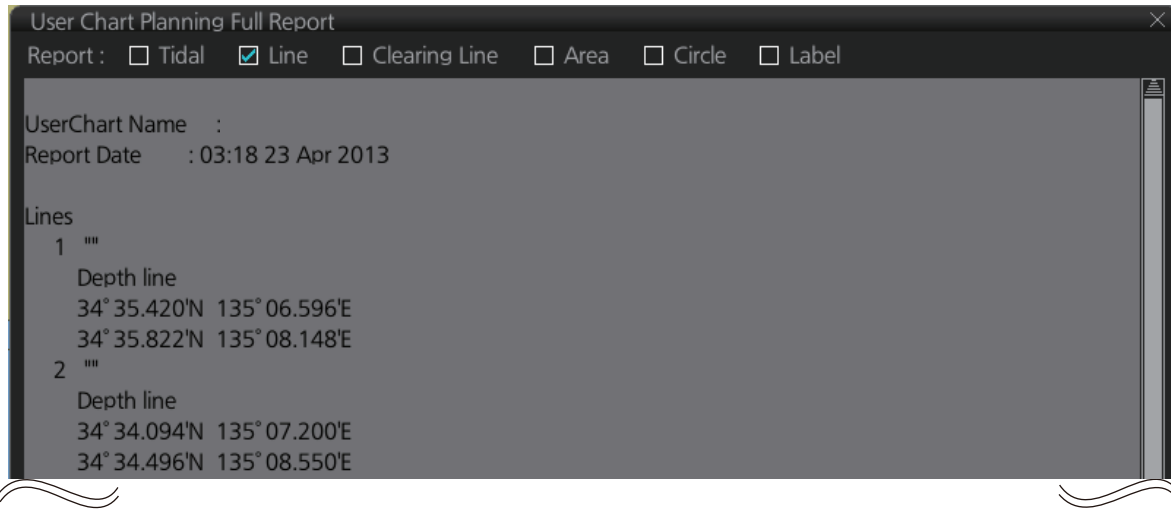

Clearing line

The Clearing line report shows the name and position of clearing lines entered on the user chart selected.

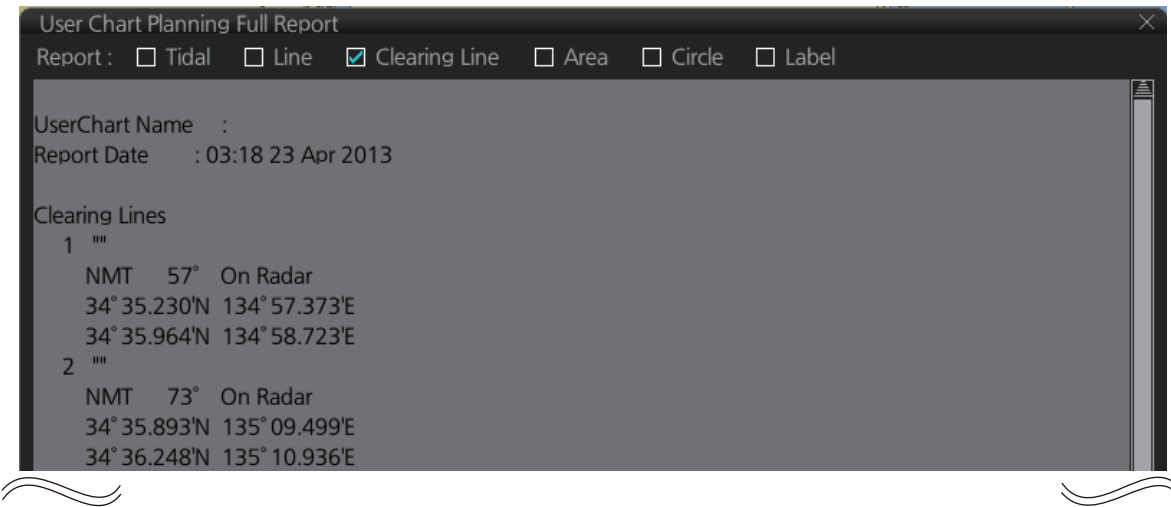

Area report

The area report provides

- Area no. and area name
- The latitude and longitude position of each point of the area
- The description of the area
- "On radar" is shown if the area is shown on the radar overlay.

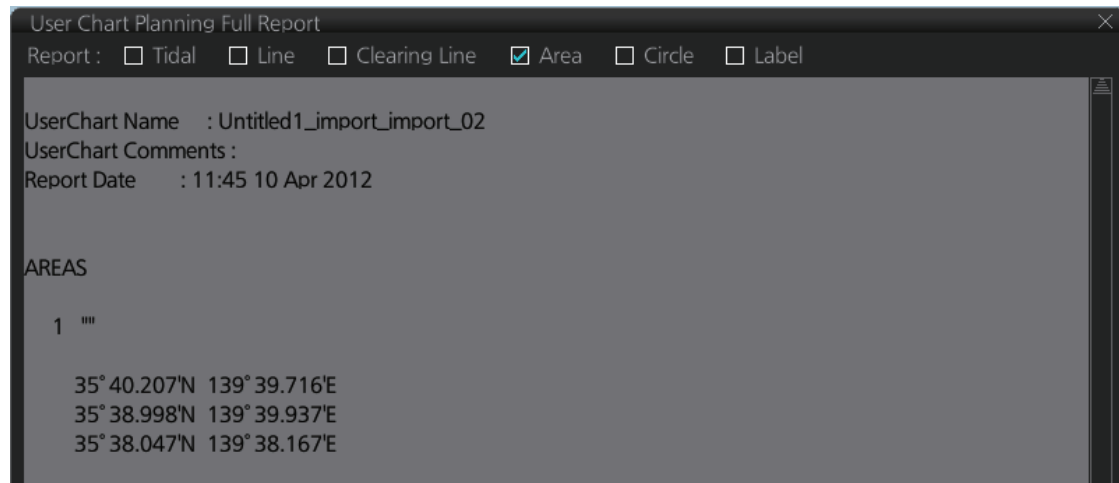

Circle report

The Circle report provides the position and radius of circles drawn on a user chart.

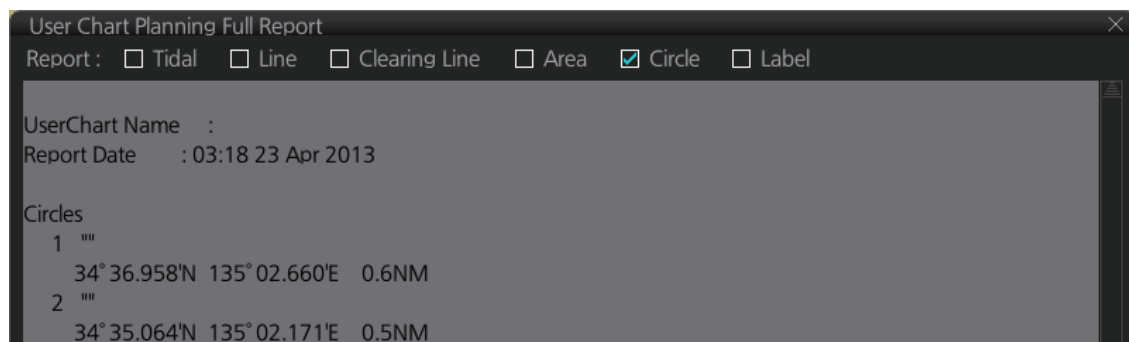

Label report

The Label report provides the latitude and longitude position of each label, the name of each label. On radar is shown if the label is shown on the radar overlay.

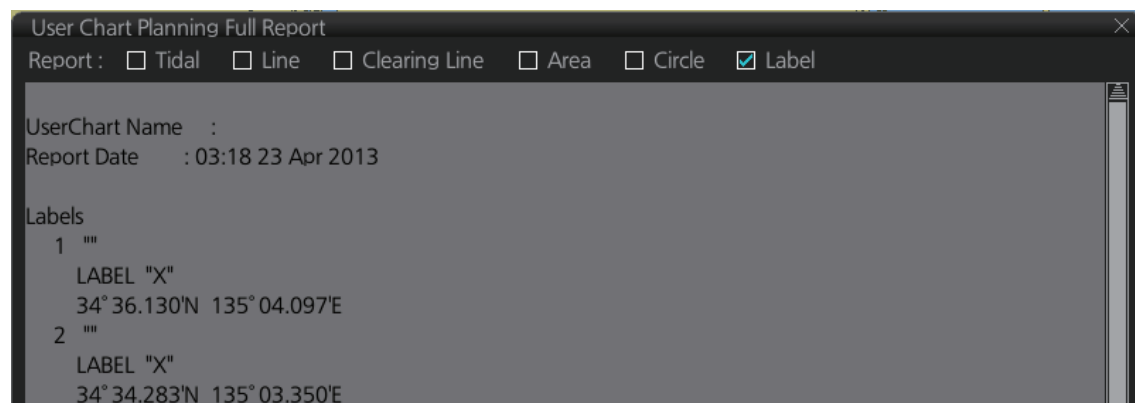

10.12 How to Select the User Chart(s) to Use in Route Monitoring

Do the procedure below to monitor a user chart without linking it to a route. Click the [NAVI] button on the Status bar then do as shown below.

1. Click the [Voyage], [User Chart] and [Select/Unselect] buttons on the InstantAccess bar™ to open the [Select Monitor User Chart] dialog box. The [Select Monitor User Chart] can also be selected by right clicking anywhere inside the [Route] information box (right side of screen) and then clicking [Monitor User Chart].

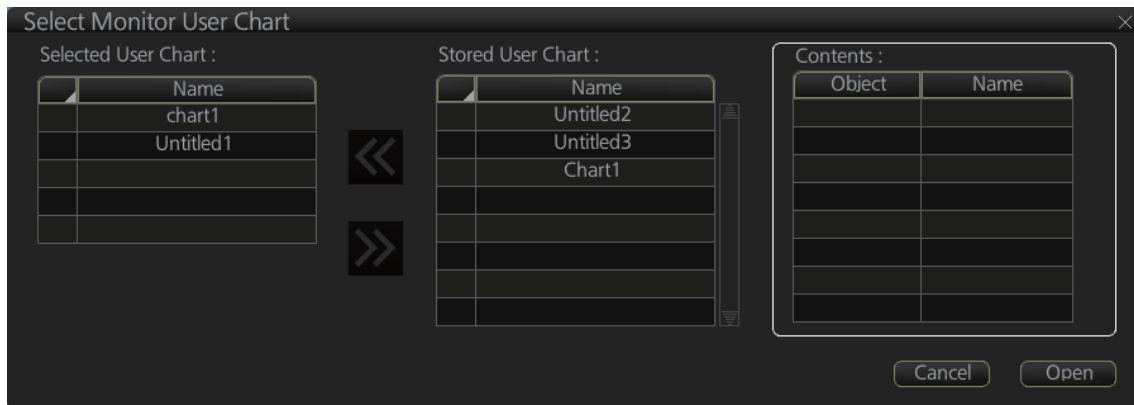

2. Check the chart(s) to use in the [Stored User Chart] window, then click the [<<] and [Open] buttons. The [Monitor Information] dialog box automatically appears, and shows the user charts selected for use in route monitoring. Click a user chart name to see details, in the [Contents] window.

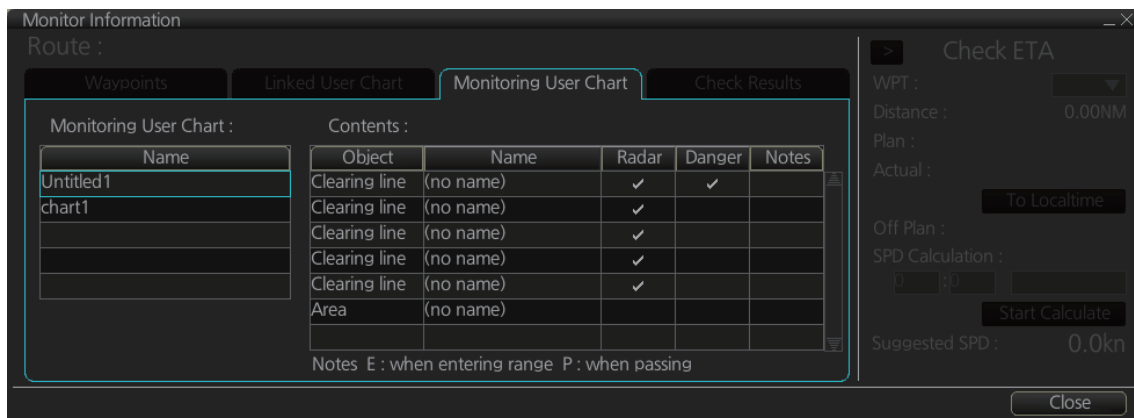

How to cancel use of a user chart during route monitoring

To cancel only a user chart during route monitoring, get into the Voyage navigation mode, then click the [Voyage], [User Chart], [Select/Unselect] buttons on the InstantAccess bar™ to show the [Select Monitor User Chart] dialog box. From the [Selected User Chart] list, select the user chart(s) to cancel, then click the [>>], and [Open] buttons.

To cancel both route and user chart in route monitoring, get into the Voyage navigation mode, then click the [Voyage] and [Stop Monitor] buttons on the InstantAccess bar™.

11. HOW TO MONITOR ROUTES

Route monitor is a means for permanent monitoring of the ship's behavior relative to the monitored route. The [Monitor Information] box displays the data on the ship's position relative to the monitored route. The monitored route consists of the following information, displayed in the electronic chart area:

- The route is displayed with red dots.
- The limits of channels of each leg are displayed with solid red lines. These limits are used to detect chart alerts when you are monitoring the route. See chapter 8 for how set those limits.
- Each leg has information about planned speed, shown in the [Monitor Information] box.
- Each leg has information about planned course to steer.

Note 1: In order to display charts with correctly updated situation, always use current date as Update Review and Display Date during your voyage. If your voyage lasts more than one week, set current date at least once per week during your voyage. See section 5.2.2 for how to set those dates.

Note 2: XTD is the distance, in a straight line, from the monitored route to the CCRP. CCRP is set at installation. Where more than one CCRP is set, select the CCRP to use from the [CCRP] page of the [Settings] menu (see section 22.13).

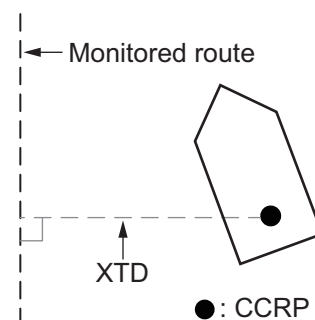

11.1 How to Start Route Monitoring

Method 1: InstantAccess bar™

In the Voyage navigation mode, click the [Voyage], [Route] and [Select] buttons on the InstantAccess bar™. Click a route then click the [Open] button.

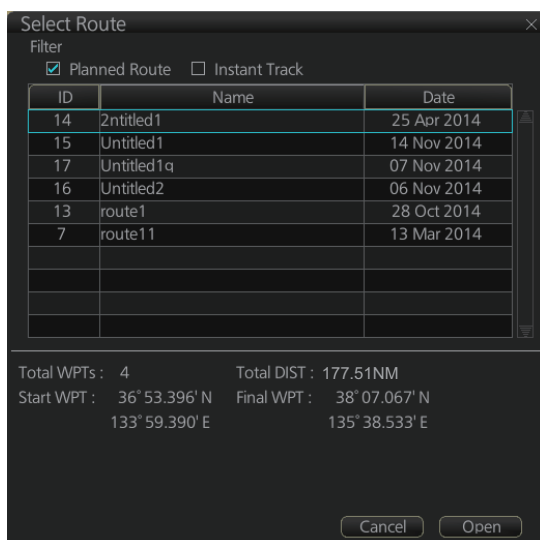

Method 2: Selection from the Route information box

Right-click the route name location in the [Route Information] box then select [Select Route] to show the [Select Route] dialog box. Select a route then click the [Open] button.

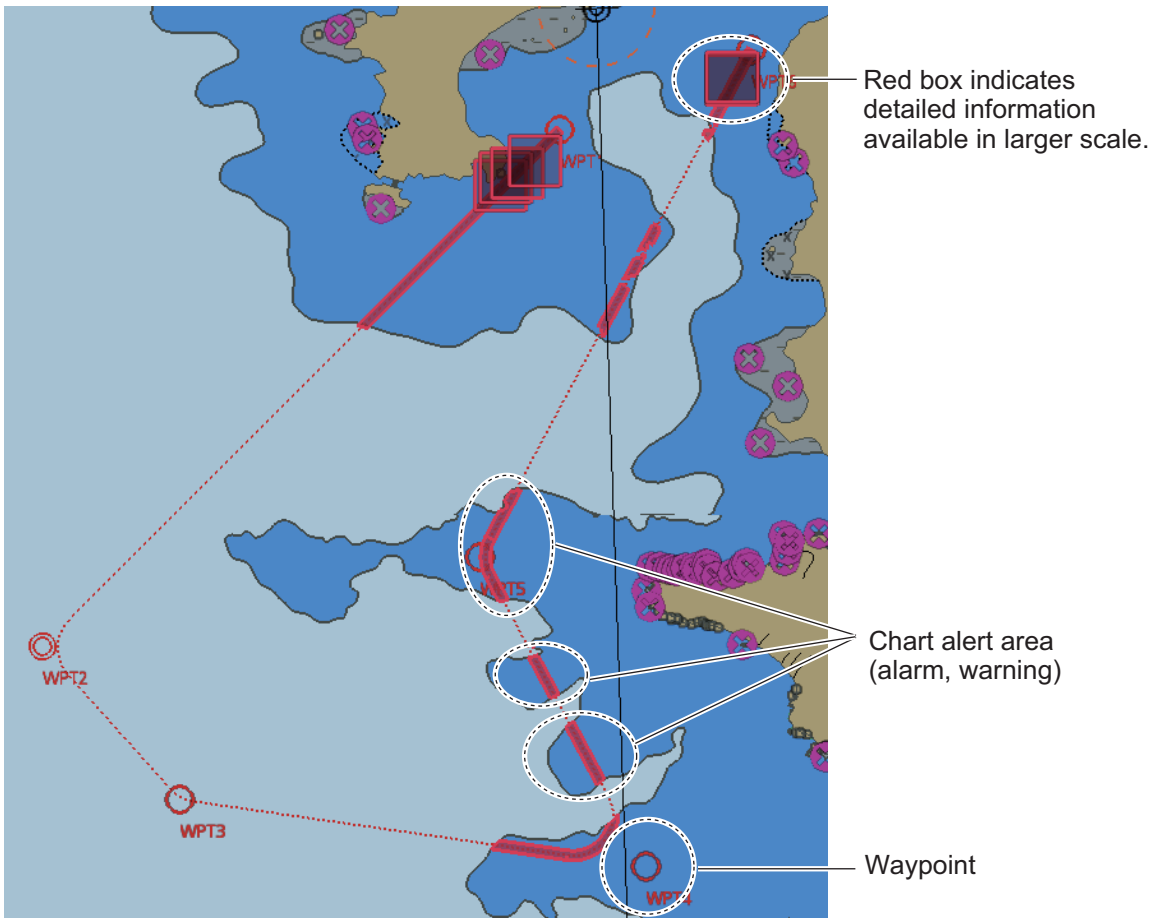
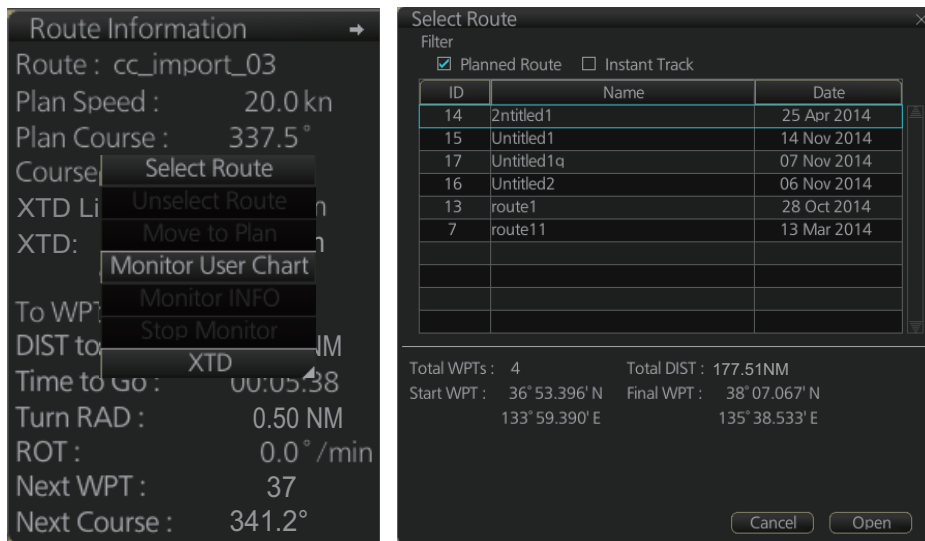

About monitoring routes

- When you choose a route for monitoring, the messages shown below appear, on the [Select Route] dialog box or in a message window, when a route cannot be opened for monitoring.
 - "Impossible turn at WPT XX" (XX=waypoint no.). Geometry of the route makes it impossible for the ship to accomplish a turn. Modify the route to make the turn possible.
 - "Bad Leg WPT XX to WPT XX" (XX=waypoint no.). A turn cannot be accomplished because the length of a leg is too short. Lengthen the leg.
 - "Bad Turn at WPT XX" (XX=waypoint no.). A turn cannot be accomplished because the calculated ROT exceeds the MAX ROT. Increase the turn radius, or decreased the planned speed.
 - "Unchecked / Check condition differs". The route has not been checked. Check the route, on the [Alert Parameters] page.
 - "Monitored in the NAVI mode". The route is currently being monitored.
 - "More than one WPT needed". The route has only one waypoint. Add more waypoints to the route.
 - "Route monitoring cannot be started. Please check ship's position and conditions." Click the [OK] button to close the message. Check ship's position and conditions of the route.
- The route check which occurs after selecting a route can take longer with C-MAP charts. Wait until the completion of the check.
- If you have small-scale chart(s) on display that have the whole eastern/western (0-180°E/0-180°W) hemisphere and a part of the other hemisphere on display, there is a limitation to display a route. To avoid this, set chart center so that the whole east-ern/western hemisphere is not on the screen.
- Route monitoring is temporarily stopped (route is grayed out) and an alert appears when position, speed or heading is lost. To restore route monitoring, change the sensor system from System to Local (from the Sensor Information box), manually enter the lost data, check [Set Drift], then switch to the DR mode.
- Route data is sent to the radar (ex. FAR-2xx7 series) at the start of route monitoring or when the ship transits a waypoint. If a route is not displayed on the radar, stop then restart monitoring at the ECDIS. A route is erased from the radar when route monitoring is stopped or the ECDIS is restarted. To redisplay the route, stop then restart monitoring at the ECDIS.
- When chart alerts are unchecked while planning a route (see section 8.1.2) and route monitoring is activated, a message appears in the permanent warning box.
 - [Safety Contour] unchecked: "Indication of crossing safety contour is Off. (in monitoring)"
 - [Areas to be Avoided] unchecked: "Indication of navigational hazards is Off. (in monitoring)"
 - Other alerts unchecked: "Indication of some prohibited areas or areas with special conditions is Off. (in monitoring)"
- If this ECDIS is connected in the network to an FMD-3200/3300 ECDIS that is interfaced with an IEC 62065 Ed.2 compliant TCS (YDK Technologies PT-900, Tokyo Keiki PR-9000, EMRI FAP-3000, Raytheon Anschutz NP-5400), the alert 174 (WPT Approach) is generated at each waypoint if the TCS is not connected to the ECDIS in route monitoring.

11.2 How to Stop Monitoring a Route (Manual, Auto)

There are two methods to stop route monitoring: (1) Get into the Voyage navigation mode, then click the [Voyage] and [Stop Monitor] buttons on the InstantAccess bar™. (2) Get into the Voyage navigation mode, then click the [Voyage], [Route] and [Unselect] buttons on the InstantAccess bar™.

When alert 691, 692 or 693 occurs, route monitoring is automatically stopped. See “route monitoring is stopped” in the Troubleshooting table in section 23.3 for details.

11.3 How to Select What Parts of a Route to Display

You can specify what parts of the monitored route to display. Click the [DISP], [SET] and [Symbol DISP] buttons on the InstantAccess bar™. Click the [Route] tab.

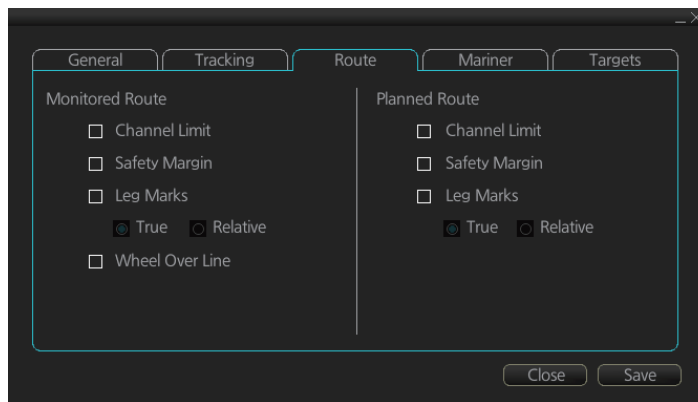

11.4 How to View Waypoint Information

Click the [Voyage] and [Monitor INFO] buttons on the InstantAccess bar™ to show the [Monitor Information] dialog box. Click the [Waypoints] tab to show waypoint info.

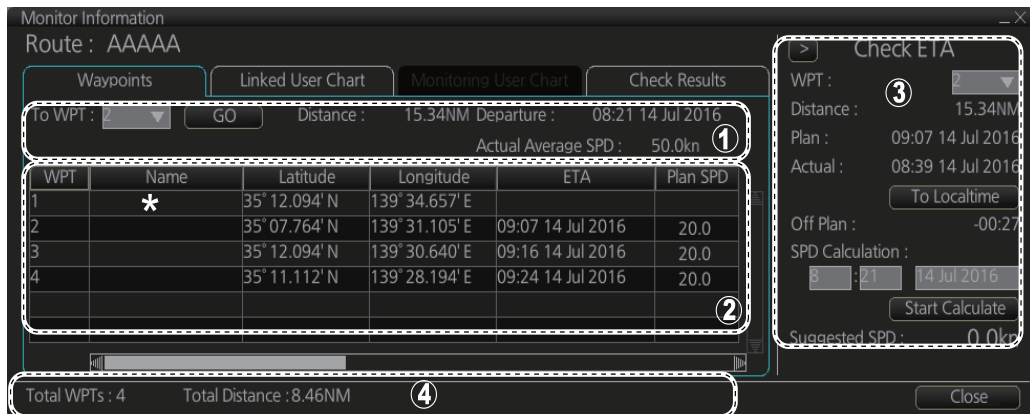

* Scroll list horizontally to view items shown in the right figure.

Leg/*	Leg/NM	STR mode	RAD/NM	XTD Limit/m	SPD MAX	Margin/m	Local Time
214.0	2.95	Rhumbline	0.80	185	22.1	40	+00:00
355.0	2.89	Rhumbline	0.80	185	22.1	40	+00:00
243.9	2.62	Rhumbline	0.80	185	22.1	40	+00:00

No.	Item	Description
1	To WPT, GO button	The system chooses a next waypoint automatically. Check that the To waypoint is the desired one. The system will automatically advance to a next waypoint when you pass the To waypoint. The default To WPT is WPT2. If you desire a different one, select it here and the click the [GO] button.
	Distance	Distance from current position to selected waypoint.
	Departure	The time the route was selected for monitoring.
	Actual Average SPD	The average speed over the ground, measured every 30 seconds.
2	Waypoint list	The waypoint list provides for each waypoint WPT no., name, latitude and longitude position, ETA, plan speed, bearing and distance to leg*, steering mode (rhumb line or great circle), radius, XTD (channel limit), speed max, margin and local time. The bearing to a leg and the display method for leg distance can be changed. For details, see section 9.4.1. *Can be changed. see [Leg/NM] on page 9-5.

3	Check ETA window	Parameters for checking ETA. The arrow to the left of [Check ETA] collapse or display the [Waypoints] and [Linked User Chart] tabs.
	WPT, Distance	Select a WPT to find the distance to that waypoint from current position.
	Plan	When planned speed is used in navigation, ETA to selected waypoint appears.
	Actual	When using current speed in navigation, ETA to selected waypoint is shown.
	To Localtime	Switch between UTC and local time for ETA. For local time, the settings used in the creation of the route are used for the ETA calculation. See section 9.4.1.
	Off Plan	The time difference between planned ETA and calculated ETA to final WPT, when different. The indication is prefixed with "-" if earlier than planned; "+" if later than planned.
	SPD Calculation	Enter ETA (time and date) to find the speed to use to arrive by the ETA.
	Suggested SPD	The system calculates suggested speed so that ETA to the WPT selected would be same as planned ETA if type of optimization was "Time table".
	Start Calculate	Click to start calculation. The button label changes to [Stop Calculate].
4	Total WPTs	The total number of waypoints in the route.
	Total Distance	The total distance of the route.

11.5 How to View Linked User Chart Information

Click the [Voyage] and [Monitor INFO] buttons on the InstantAccess bar™, then click the [Linked User Chart] tab in the [Monitor Information] dialog box.

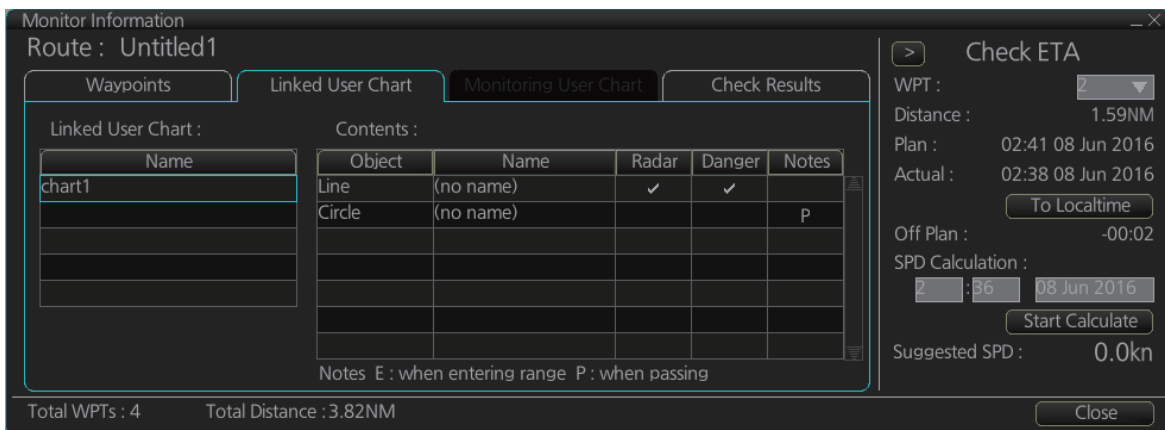

The [Linked User Chart] list shows all the user charts linked with the monitored route and their contents. Click a user chart name to show the contents of the chart in the [Contents] window. Items with a checkmark are activated. For the [Check ETA] window, see the preceding page.

11.6 How to View User Chart Object Information in Route Monitoring

In route monitoring, you can cursor pick user chart objects to show their information. Put the cursor on the user chart symbol to show the pop-up menu. Select [User Chart INFO] from the pop-up menu. Below are some examples of user chart info.

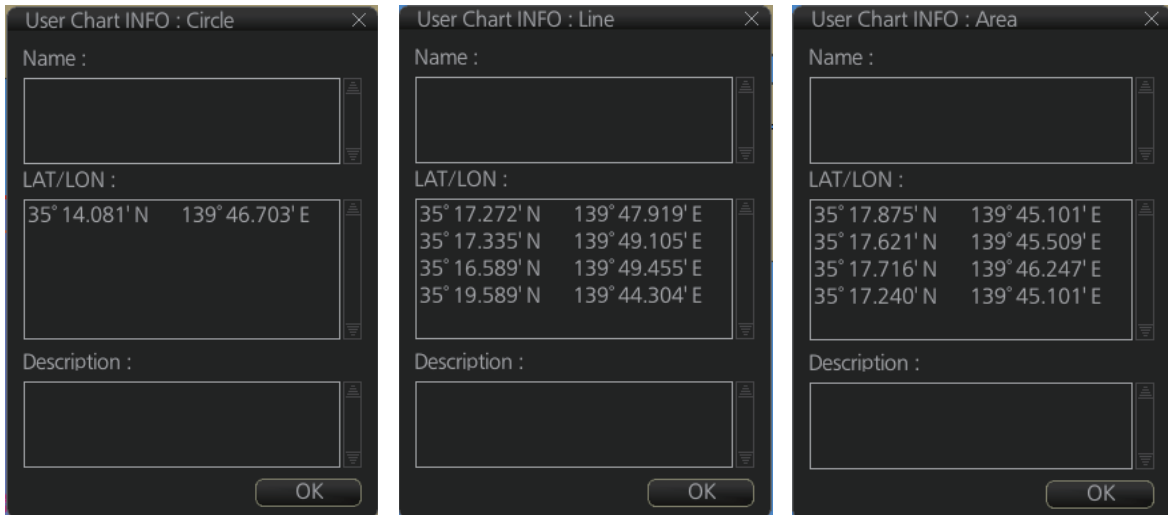

User chart INFO: Circle

User chart INFO: Line

User chart INFO: Area

11.7 How to Change Monitored Route to Planned Route

The monitored route can be transferred to the Voyage planning mode. This is useful when you don't need the route for monitoring but want to edit it. To transfer the monitored route, click the [Voyage], [Route] and [Move to Plan] buttons on the InstantAccess bar™.

Up to five planned routes can be shown on the display. If you try to display another route, the route list appears. Deselect a route in order to transfer the monitored route to the Voyage planning mode.

Note: When the monitored route is changed to a planned route, using the [Move to Plan] function, the operating mode changes from the Navigation voyage mode to the Voyage planning mode. If this operation is tried directly after the ECDIS starts and the change does not occur, click the [NAVI] button on the Status bar then try again.

11.8 How to Use Instant Track to Return to or Deviate from Monitored Route

The instant track feature provides a temporary track, consisting of four waypoints, to return to or deviate from the monitored route.

There are two instant track modes: [Safe Off Track] and [Back to Track].

[Safe Off Track]: This mode provides a track from the monitored route to a safe location to avoid collision or the like.

[Back to Track]. This mode creates a track to follow to return to the monitored route when the vessel goes outside the channel limits.

The mode is automatically selected according to whether a monitored route is active or not and the amount of off course. Further, if a monitored route is active while following the instant track route, the instant track mode can be changed manually.

Condition	Mode	Manual mode switching
Neither monitored route nor instant track route active.*	Safe Off Track	No
<ul style="list-style-type: none"> Both monitored route and instant track route are active.* The absolute value of off track is within the channel limit setting. 	Safe Off Track	Yes
<ul style="list-style-type: none"> Both monitored route and instant track route active.* The absolute value of off track is outside the channel limit setting. 	Back to Track	Yes

* An additional instant track route can be joined to the instant track route related to a monitored route.

The parameters for the instant track (channel limit, turn radius, etc.) can be set on the [Instant Track] page. See section 21.4.

11.8.1 Safe off track mode

If it becomes necessary to deviate from the monitored route; for example, to avoid collision, use the safe off track mode to create an instant track to a safe location.

1. Click the [Instant Track] button on the InstantAccess bar™. The [Instant Track] pop-up window appears and displays the message "Please click a destination."

Note 1: If a monitored route is active, the [Back to Track] mode can also be selected.

Note 2: If a monitored instant track route is already active, an instant track mode different from the currently active one can be selected.

2. Click a destination. The location is marked with an orange circle and arrow. The message "Please click a point to decide an angle." appears in the [Instant Track] dialog box. The location must be within 50 NM of current position.

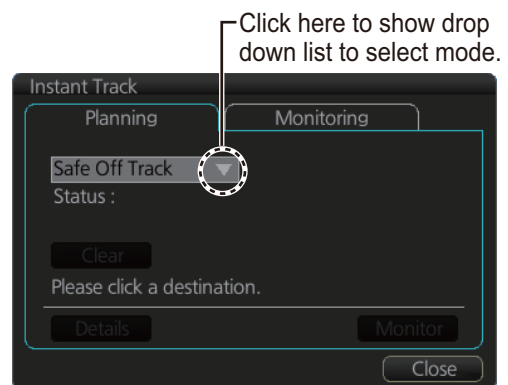

When monitored route is active

- Roll the trackball to select the angle of approach to the destination then click.

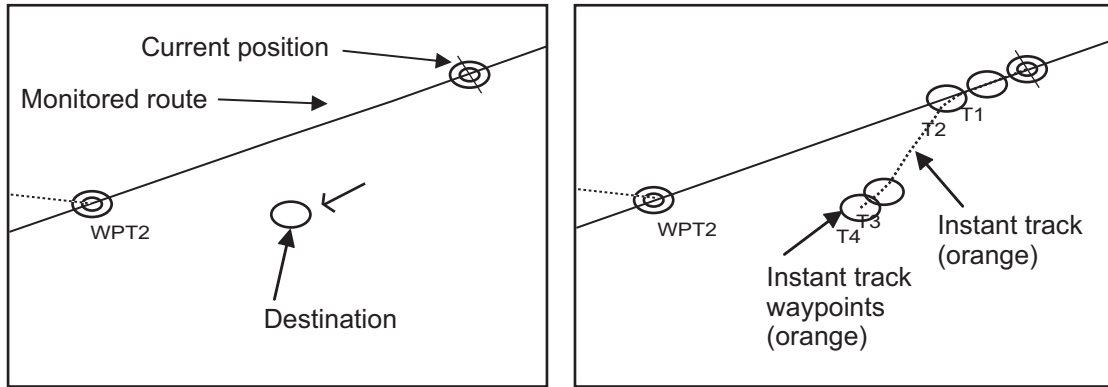

① Click destination point. A circle and arrow appear.

② Click a location to set desired angle of approach. Instant track is drawn.

The system uses ship position, speed, angle of approach to create an instant track route. The track is also checked for hazardous objects and the like against the chart alerts.

During the calculation, the [Instant Track] dialog box window shows "Checking" in the [Status] field. If, after completion of the calculation, the track is suitable, the message "OK" replaces "Checking". The track and its waypoints, labeled [T1] - [T4], are colored orange. The track is saved to the database as "Instant Track_XXX" (XXX=001 - 400).

If there is a problem with the track, an error message appears and the track is erased from the screen. See section 11.8.3 for all the instant track messages and their meanings.

To return to the monitored route, click a waypoint on a leg of the route to create an [Instant Track] to use to return to the monitored route.

11.8.2 Back to track mode

When the vessel goes off track, the alert "172 Off Track Alarm" appears in the [Alert] box. To create an instant track to return to the monitored route, use the back to track mode as follows:

- With a monitored route active, click the [Instant Track] button on the InstantAccess bar™. The message "Please click a WPT on Leg." appears on the [Planning] page.

Note 1: If a monitored route is active, the [Safe Off Track] mode can also be selected.

Note 2: If a monitored instant track route is already active, an instant track mode different from the currently active one can be selected. Further, a completely new instant track route to the original monitored route can be created.

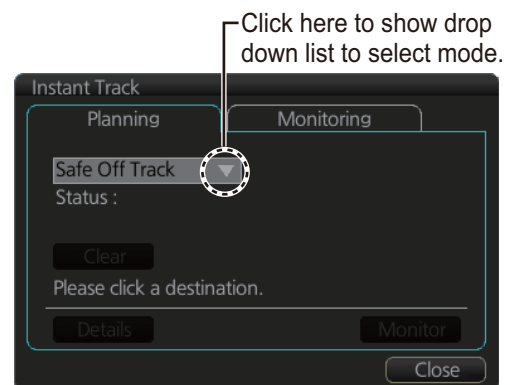

When monitored route is active

11. HOW TO MONITOR ROUTES

2. Click a leg or a waypoint on the monitored route. The location must be within 50 NM of current position.

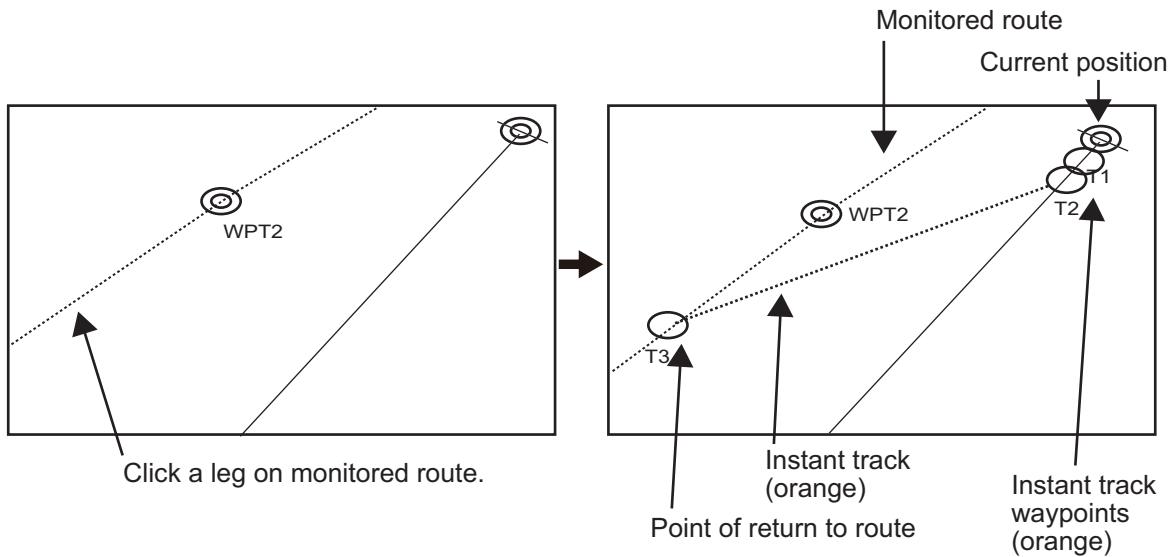

The system uses ship position, speed and final waypoint to create a track. The track is also checked for hazardous objects and the like against the chart alerts.

During the calculation, the [Instant Track] dialog box shows "Checking" in the [Status] field. If, after completion of the calculation, the track is suitable, the message "OK" replaces "Checking". The track and its waypoints, labeled [T1] - [T3], are colored orange. The track is saved to the database as "Instant Track_XXX" (XXX=001 - 400).

If there is a problem with the track, an error message appears and the track is erased from the screen. See section 11.8.3 for all the instant track messages and their meanings.

11.8.3 Instant track messages

The table below shows all the instant track messages and their meanings.



Message	Meaning	Color
(1) Instant Track mode		
"Back to Track"	Back to track mode	White
"Safe Off Track"	Safe off track mode	White
(2) Check result, error message		
"Could not create the Track."	The track could not be created.	Yellow
"Too far destination from own ship."	Selected destination is 50 NM or more from current position.	Yellow
"Checking"	Checking route.	Red
"OK"	Instant track checked and is suitable to follow.	Green
"NG"	Route check failed.	Red
"Check error"	Route check error.	Red
"Instant track is expired."	Route monitor timeout.	Red
"Too many WPTs in monitoring route."	More than 190 waypoints are in the monitored route. (Instant track cannot be created.)	Red
(3) User operation message		
"Please click a destination."	Select a destination in the [Safe Off Track] mode.	White
"Please click a point to decide an angle."	Set the angle of approach in the [Safe Off Track] mode.	White
"Please click a WPT on leg."	Click a waypoint on a leg in the [Back to Track] mode.	White
(4) Name of instant track route		
InstantTrack_XXX (XXX: 0001 - 400)	Name of monitored instant track route	White

11.8.4 Instant track details

You can see the location and alert type found in an instant track by clicking the [Details] button on the [Instant Track] pop-up window.

Note: If the Status is not [OK], an alert (alarm or warning priority, depending on setting) appears in the Alert box.

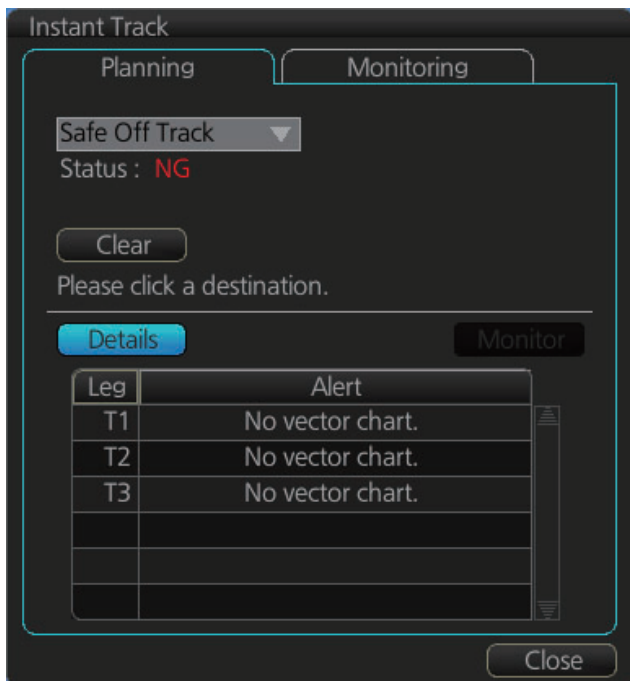

11.8.5 How to monitor, stop monitoring an instant track

How to monitor an instant track

If the route check results is "OK", click the [Monitor] button on the [Planning] page in the [Instant Track] dialog box to start monitoring the instant track route. Click the button before the time remaining counts to zero, otherwise the instant track will be canceled, followed by the message "Instant track is expiration." After the [Monitor] button is clicked the [Monitoring] page is opened. The [Monitoring] page shows the name of the instant track and the instant track mode.

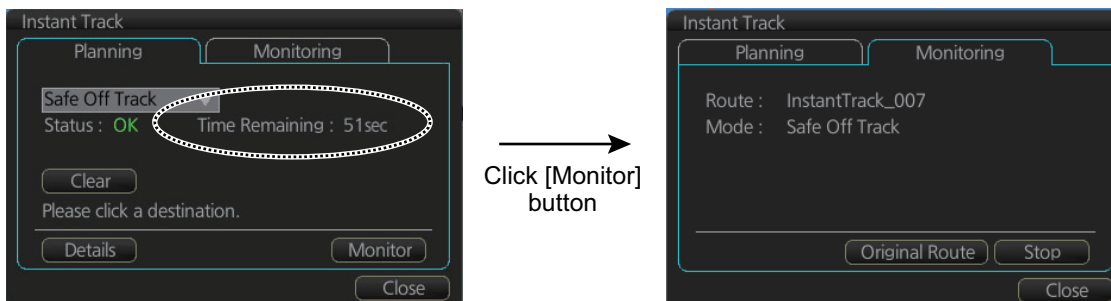

The vessel follows the instant track route in the same method as a monitored route, which is grayed out to indicate it is inactive. For the instant track route connected to a monitored route, the previous instant track route is also grayed out to show it is inactive. Any additional instant track routes are erased.

To close the [Instant Track] dialog box, click the [Close] button. (The system continues monitoring the instant track route.)

The following occurs when sensor data is lost while using the instant track function.

Monitoring condition	Result
Instant track route monitoring.	<ul style="list-style-type: none"> An instant track route under creation is deleted. No route can be created. The [Stop] button is pushed or the instant track route is followed until its completion. After the instant track route is completed, an error message appears and the [Instant Track] dialog box closes.
No monitored route	An instant track route under creation is deleted.
Monitored route active	After the route is completed, an error message appears and the [Instant Track] dialog box closes.

How to stop monitoring an instant track

Click the [Stop] button on the [Instant Track] pop-up window to stop monitoring the instant track. The system returns to monitoring the monitored route.

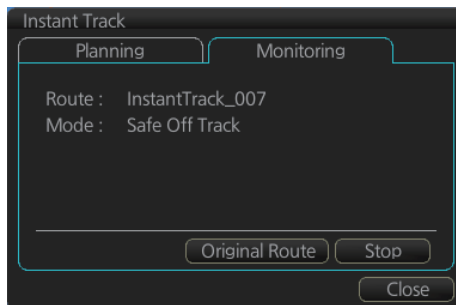

For the [Back to Track] mode, the instant track mode is canceled when the vessel returns to the monitored route. The instant track is grayed out to show that it is inactive.

11.8.6 How to return to a monitored route when following an instant track route (safe off track mode only)

Do the following to return to a monitored route while following an instant track route.

1. While monitoring an instant track route, click the [Original Route] dialog box and its [Monitoring] page in the [Instant Track] dialog box to show the [Select Route] dialog box. Check [Planned Route] to show a list of planned routes, or check [Instant Track] to show a list of instant track routes.

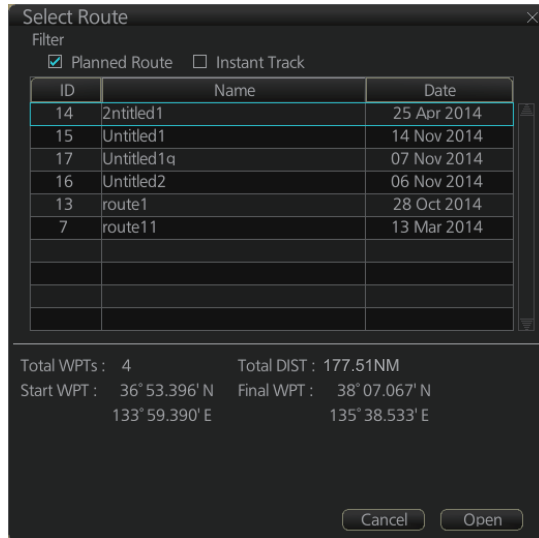

2. Select the route to use. The original route or the instant track route currently in use cannot be selected.
3. Click the [Open] button to close the dialog box. The vessel starts following the newly selected route.

When an instant track route is completed, the vessel starts following the route selected at step 2.

11.8.7 Button label and equipment state

The label on the button at the position circled in the figure below changes according to the state of the instant track and TCS (where an EC-3000 with TCS functionality is connected to the same network).

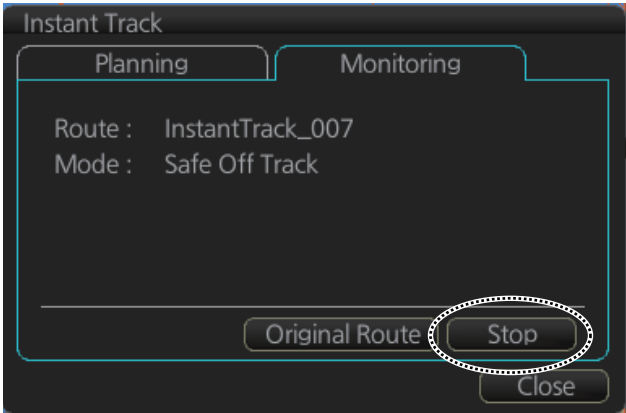

Instant track state	TCS state	Button label
Creating	OFF	Monitoring
	ON	Execute (same function as Monitoring)
Monitoring	OFF	Stop
	ON*	Stop
Return to original route after back to track mode	OFF	Reset (Instant track is deleted; another instant track maybe created)
	ON	Reset

* Button inoperative.

11.9 How to Share Route During Route Monitoring

With multiple units (FMD-3xx0, FCR-2xx9, FAR-3xx0) connected, the master unit can share a monitored route with the units mentioned above

Follow the procedure below to set master and backup units.

Follow the procedure below to enabling the route sharing feature.

1. Open the menu, select [Monitoring] from the [Shared] menu to show the [Setting] dialog box.

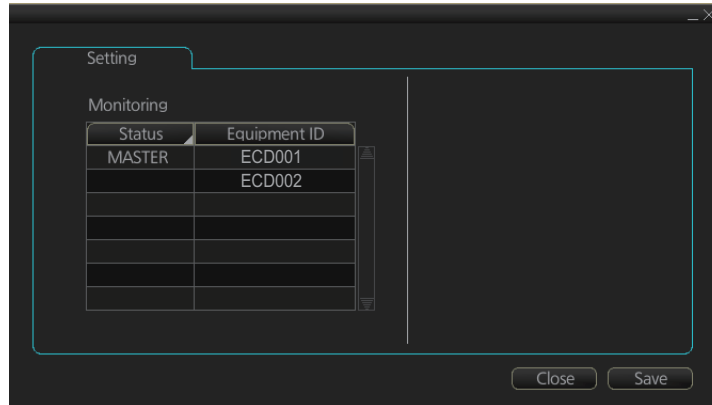

2. Right click the equipment ID of the unit to show the pop-up menu. Select [MASTER], [BACKUP], [SYNC] or [CLEAR] as appropriate.
 - [MASTER]: Assigns selected unit as the master unit. One unit must be assigned as the master unit.
 - [BACKUP]: Assigns the selected unit to share route monitoring. Only one unit can be assigned to share route monitoring. When route monitoring starts on the master, the route and its information are displayed on the backup. If the master stops during route monitoring, the backup will act as the master.
 - [SYNC]: Selected unit receives and displays the route data output from the master, but does not monitor the route displayed on the master.
 - [CLEAR]: Removes the selected unit from route monitoring sharing.

Note: To restore the original setting for units, click the [Status] column, then select [Reset].
3. Click the [Save] button to save settings, then click the [Close] button to finish.

12. NAVIGATION TOOLS

This chapter presents the various navigation tools available with the system. With the exception of the divider and mini-conning display, the tools listed below are in the [Overlay/NAV Tools] Box.

- TT/AIS (see chapters 13 and 14)
- Echo (see chapter 16)
- RCB Common (see chapter 16)
- PI
- Look-ahead
- Ring (Range rings)
- Predictor
- Anchor Watch
- UKC (Under Keel Clearance)
- Curved EBL*
- Mini Conning
- Divider

*: Shown only when a EC-3000 with TCS functionality is connected to the network.

12.1 How to Access the Tools in the Overlay/Nav Tools Box

The [Overlay/NAV Tools] box is located at bottom-right position on the screen, and contains various pages of functions for navigation. There are two methods to select pages.

- Click the page selection buttons on the [Overlay/NAV Tools] box.
- Right-click the page name on the [Overlay/NAV Tools] box to show a context menu of the available pages, as shown right.

The window that appears to the left of the [Overlay/NAV Tools] is shown except when the [TT/AIS] page is selected.

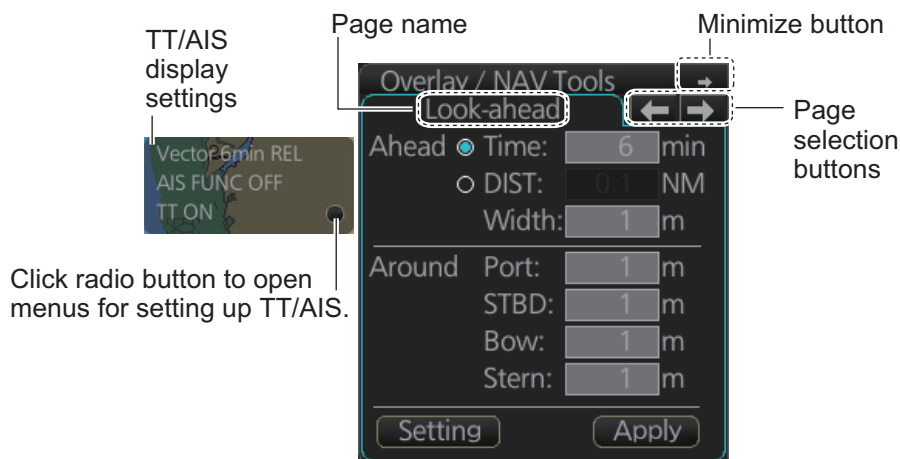
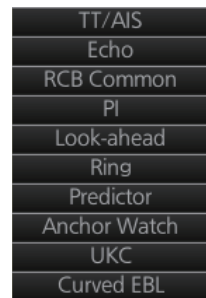

Overlay/NAV Tools box (Look-ahead page)

12.2 Parallel Index (PI) Lines

The parallel index lines are useful for keeping a constant distance between own ship and a coastline or a partner ship when navigating. There are six sets of PI lines (PI-P6) and you can turn them on or off individually. Select the PI line to process with the [Display] pull-down list then click the [ON] or [OFF] button as appropriate. One, two, three or six lines can be shown - the actual number of lines shown depends on the line interval.

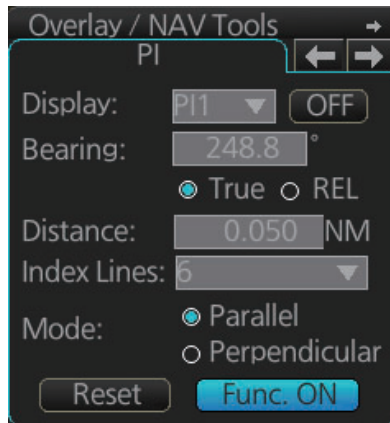

The bearing can be set two ways: with the scrollwheel or dragging the PI line on the screen.

12.2.1 How to activate, deactivate PI lines

Select the PI line(s) set to activate or deactivate with the [Display] drop-down list. Activate or deactivate the set selected with the [ON], [OFF] button.

The [Func. ON], [Func. OFF] button globally activates, deactivates all PI lines selected to ON.

12.2.2 PI line bearing reference

PI line bearing reference may be relative to own ship's heading (Relative) or referenced to North (True). Select [True] or [REL] as applicable.

12.2.3 Number of PI lines to display

The maximum number of PI lines to display may be selected from 1, 2, 3 or 6 lines as below. The actual number of lines visible may be less depending on line interval. Select the number of lines to display at [Index Lines].

12.2.4 PI line mode

The PI line mode can be set for parallel (0-degrees) or perpendicular (90-degrees). Select [Parallel] or [Perpendicular] at [Mode].

12.2.5 How to adjust PI line orientation, PI line interval

There are two ways to adjust PI line orientation and PI line interval: through the menu and on the screen.

How to adjust PI line orientation, PI line interval from the menu

1. Set the orientation with [Bearing].
2. Set the line interval with [Distance].

How to adjust PI line orientation, PI line interval on the screen

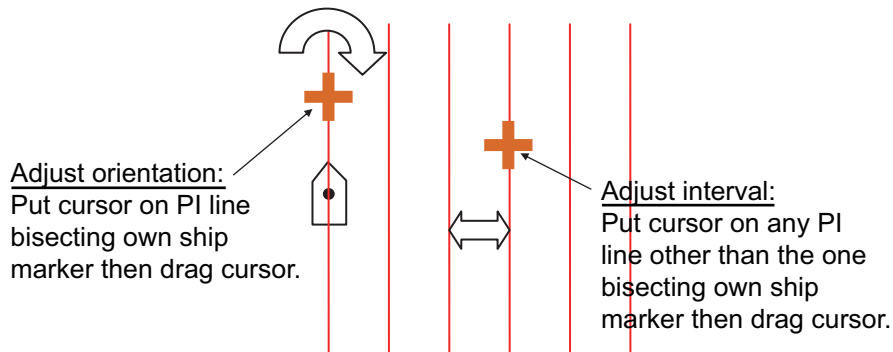

How to adjust orientation and interval, multiple PI lines

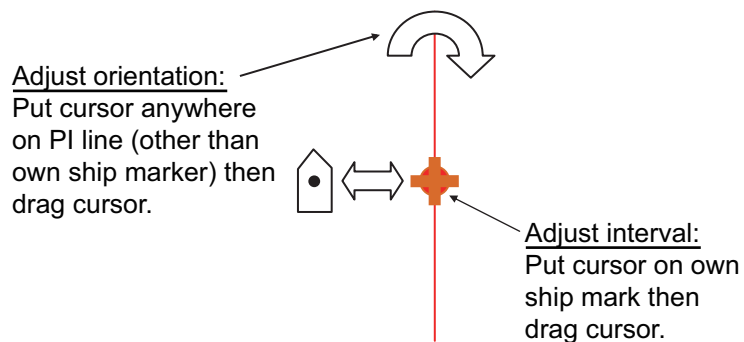

How to adjust orientation and interval, single PI line

12.2.6 How to reset the PI lines

You can automatically return PI lines to default orientation, 0-degrees for parallel orientation, 90-degrees for perpendicular orientation. This is faster than doing it manually. Click the [Reset PI Lines] button to reset the parallel lines.

12.2.7 How to adjust PI line length

You can adjust the forward and backward lengths of each PI line as follows.

1. Open the main menu and select [NAV Tools], [PI Lines] and [Truncate].

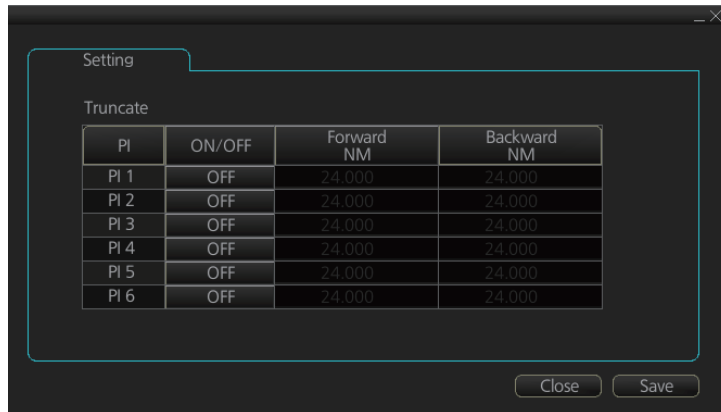

2. If not already displayed, click the ON/OFF button to display the PI line whose length you want to adjust.
3. Click the value in [Forward] and [Backward] columns to adjust their lengths, referring to the illustration below.

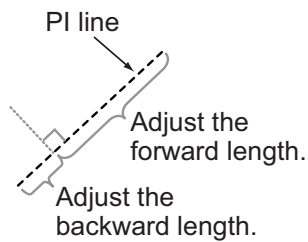

4. Click the [Save] button to finish.

12.3 Look-ahead

[Look-ahead] sets the area ahead and around own ship for which to check for safe navigation. See section 8.2 for how to activate own ship check.

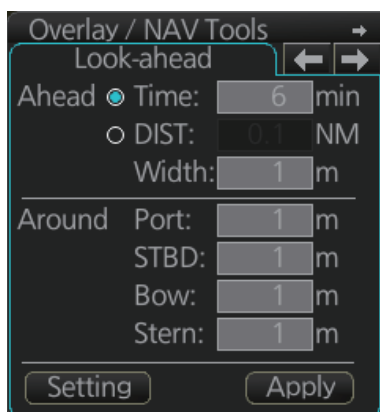

12.4 Ring

The range rings are the concentric set of rings on the ECDIS display. They provide an estimation of the range to an object. You can turn them on or off from the [Ring] page.

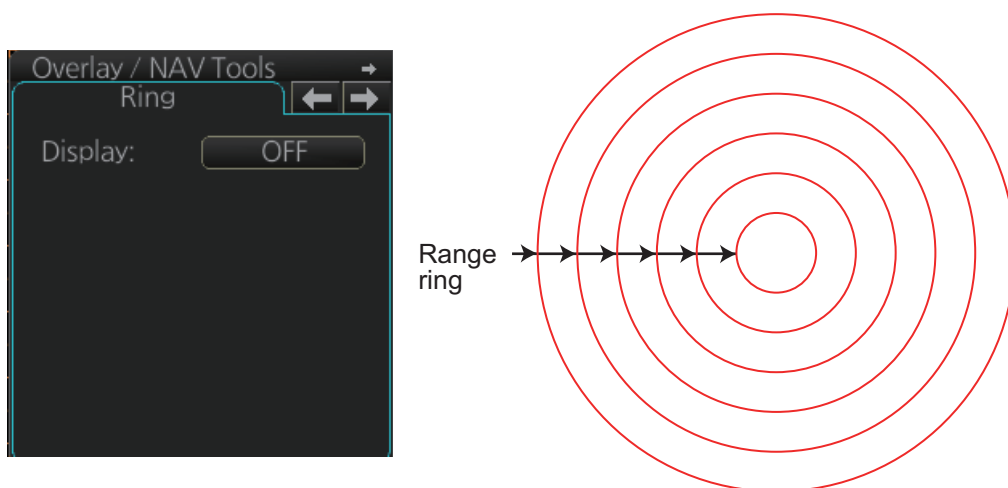

The interval between rings changes with the chart scale as shown in the table below.

Chart scale	Ring interval (nm)	Chart scale	Ring interval (nm)
1:1,000	0.025	1:100,000	2.0
1:2,000	0.05	1:200,000	4.0
1:5,000	0.10	1:500,000	8.0
1:10,000	0.25	1:1,000,000	16.0
1:20,000	0.5	1:2,000,000	20.0
1:50,000	1.0		

How to select range calculation method

The range calculation method for the range rings can be selected to Rhumbline or Great Circle. Do as follows to select a calculation method.

1. Open the menu, then select [NAV Tools] and [Geometry] to show the [Geometry] page.

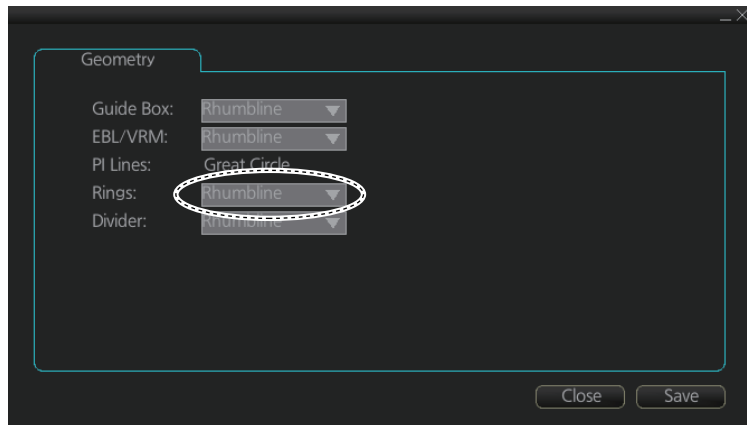

2. Select [Rhumbline] or [Great Circle] with the drop down list box for [Rings].
3. Click the [Save] button to save the setting, then click the close button to finish.

12.5 Predictor

The predictor is a tool for estimating your ship's future positions and behavior. The on-screen predictor graphic consists of three pieces of your ship, drawn in true scale to successive future positions. The position of the third symbol will be your approximate position at the end of the time interval selected. The predictor is calculated using current speed and rate of turn. Docking speed components (transversal bow speed, transversal stern speed, transversal center speed and rate of turn) are assumed to be stable during the prediction period. The predictor can be used in every steering-state, including manual steering.

To activate and set the Predictor, show the [Predictor] page. Turn the display on or off with [Display]. Set the time (30, 60, 90, 120, 150, 180 seconds), with [Time].

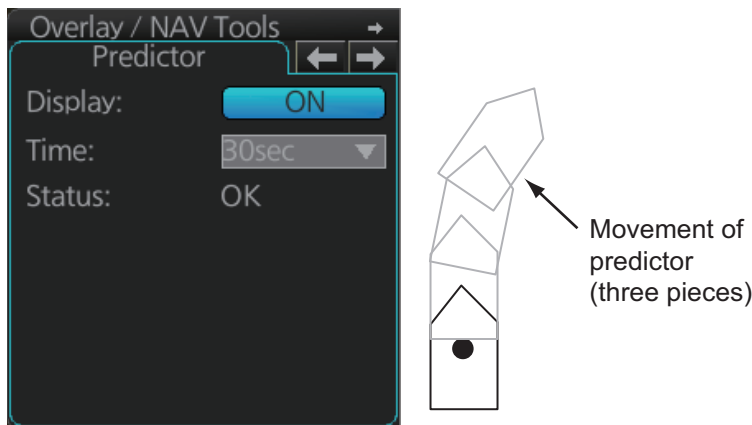

The Predictor is updated every three seconds internally and the status of the predictor is shown with [Status] as shown in the table below.

Indication	Meaning
OK	Speed is suitable in accordance with estimation of ship's dynamics.
Not Enough Speed	Speed is too low, in accordance with estimation of ship's dynamics.
Not Available. Reset Filter May Restore.	Calculation not possible, in accordance with estimation of ship's dynamics.

Note: The ship speed must be 0.5 kn or higher. The predictor may not be displayed or may not work properly if the speed is lower.

12.6 Anchor Watch

The anchor watch feature checks to see if your ship is drifting when it should be at rest. The anchor mark appears at the location of your ship's anchor. You can adjust the location for the anchor (see section 22.13).

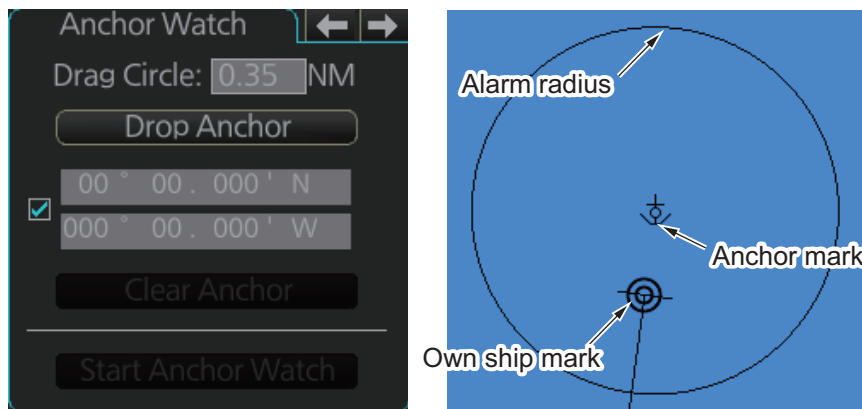

To set the anchor watch:

1. Select the [Anchor Watch] page.
2. Set the alarm radius (in nautical miles) with [Drag Circle].
3. Drop the anchor then click the [Drop Anchor] button.
The anchor mark and alarm radius circle appear. You can adjust the location of the anchor mark and the alarm radius by drag and dropping them.
Note: A latitude and longitude position can be set as the anchor watch position. Put a check mark in the box below the [Drop Anchor] button to show the latitude and longitude input boxes. Enter latitude and longitude then click the [Drop Anchor] button.
4. Click the [Start Anchor Watch] button to start the anchor watch.

If your vessel travels more than the distance set here, the corresponding caution is generated.

If your ship drifts more than the anchor watch setting, the Alert 495 (ALF format: 30802) "Anchor Watch Setting" appears. The alert is escalated from warning level to alarm level if the alert is not acknowledged within two minutes. Also, if your vessel returns to within the tolerable radius, the alert is status is automatically changed to rectified.

To continue to use the anchor watch, click the [Clear Anchor] button to set the alarm about your current position. To stop the anchor watch, click the [Stop Anchor Watch] button. The caution is not generated even if your ship drifts more than the distance set with [Drag Circle]. Also, if the anchor watch alert is active and the [Stop Anchor Watch] button is clicked, the alert is also acknowledged and rectified.

12.7 UKC (Under Keel Clearance)

12.7.1 UKC overview

UKC is the distance between the deepest point of the vessel's hull and the seabed. The UKC feature continuously checks the ship's draught setting and actual speed.

When a look-ahead area is set and the depth within the set area gets shallower than the UKC, the Alert 30173 "UKC Limit" is generated.

UKC takes into account the amount of hull subsidence (Squat Effect). The evaluation-criteria for Alert 30173 is not based solely on the distance from the keel to the seabed, UKC or draught.

Note: When conducting a route check, UKC is calculated based on the planned speed for each leg.

The Echo Alarm Limit is compared with the depth (raw data) from the sensor. If the depth is smaller than the echo alarm limit, the Alert 30801 "Depth Limit" and Alert 30644 "Actual UKC Limit" are generated.

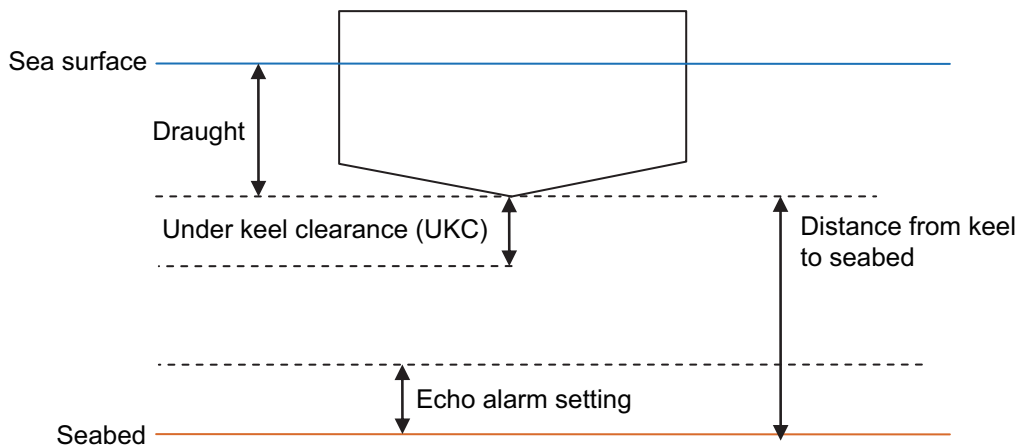

12.7.2 How to set UKC

1. Select the [UKC] page from the [Overlay/NAV Tools] box.
2. Use [Echo Alarm Limit] to set the distance for the echo alarm. To activate the alarm, click the [ON/OFF] button to show [ON].
3. At [UKC Limit], set ship's UKC limit. To activate the UKC feature, click the [ON/OFF] button to show [ON].
4. Use [Current Draught] to set your ship's draft. Be sure to change the setting whenever the draft changes.
5. Use [Type] to set the shape of your ship's hull to show on the [UKC] window, [V-shape] or [Concave]. See the figure on the next page.
6. Click the [Apply] button to affect the changes.

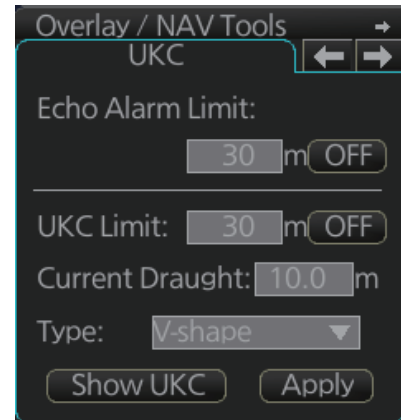

12.7.3 UKC window

The UKC window provides a visual graphic of the relationship between UKC, draft and current depth. The window can be shown or hidden as desired and located anywhere within the electronic chart area. To show the window, click [Show UKC] on the [UKC] page. To move the window, drag and drop.

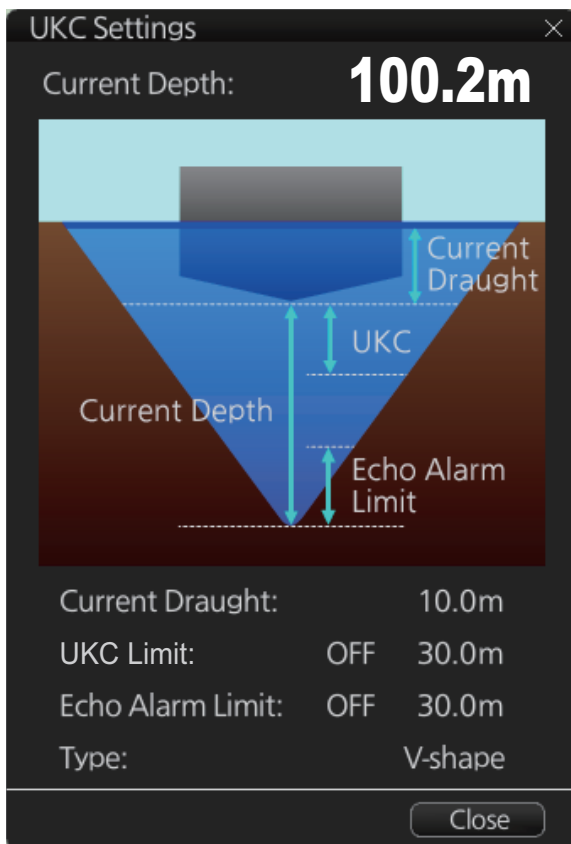

V-shape hull presentation

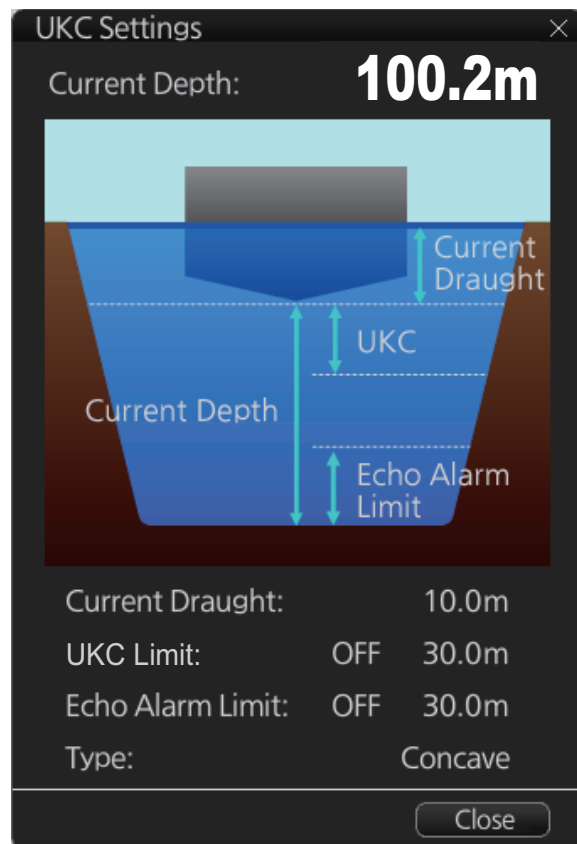

Concave hull presentation

12.8 Curved EBL

The [Curved EBL] function shows the planned steering radius. You can use this function to determine the best location to begin a turn. You can also use the [Curved EBL] function to determine whether a turn is conducted as planned.

To show/hide the [Curved EBL], click the [ON]/[OFF] button on the [Curved EBL] page of the [Overlay/NAV Tools] box.

Note: This function is only available when a EC-3000 with TCS functionality is connected to the network.

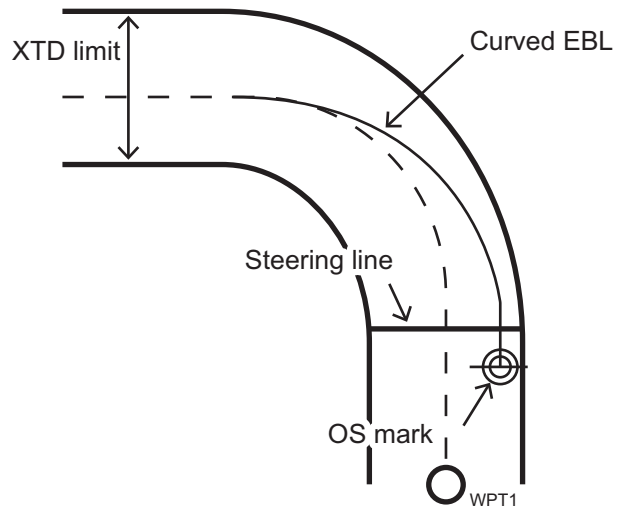

12.9 Mini Conning Display

The mini conning display, available in the Voyage navigation mode, provides various navigation information and is set during the installation. The display example below shows heading, Doppler log speed and rudder angle. To show or hide the mini conning display, click the [Mini Conning] button on the InstantAccess bar.

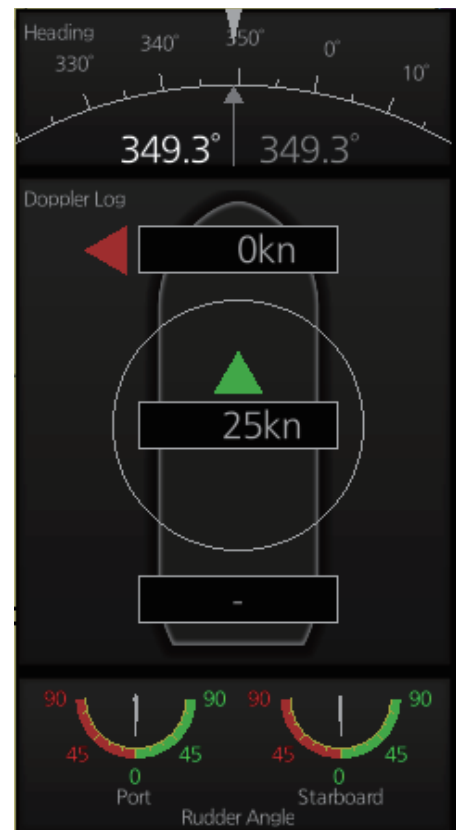

12.10 Divider

The divider performs the following calculations:

- Range and bearing between two points
- Total TTG from start to end
- Total distance from start to end
- TTG between two points
- Total distance from start to end

The divider is available in the Voyage navigation and Voyage planning modes. Only one divider can be displayed. The divider is neither saved nor shared among FMD-3000, FAR-3xx0, FCR-2xx9.

12.10.1 How to use the divider

Do as shown below to use the divider.

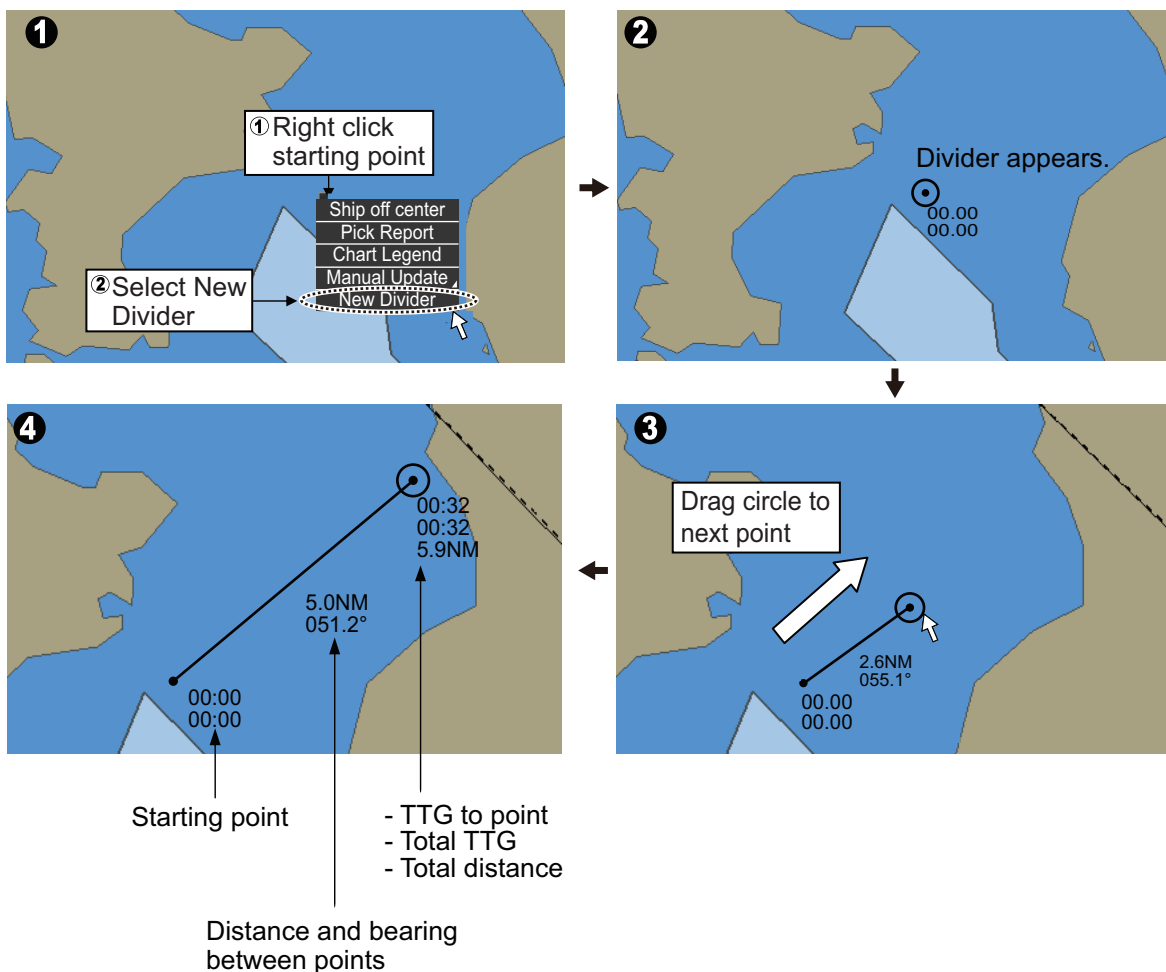

How to delete points

Point(s) can be deleted. Put the cursor on a point, right click, then select [Delete Points] from the pop-up menu. The point(s) deleted depends on the point selected.

End point

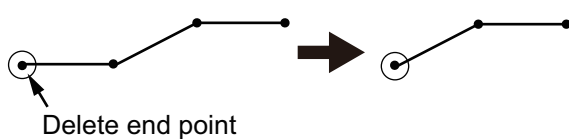

Intermediate point

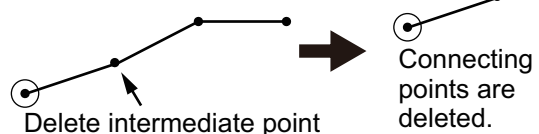

You can also drag from an intermediate point to make another point.

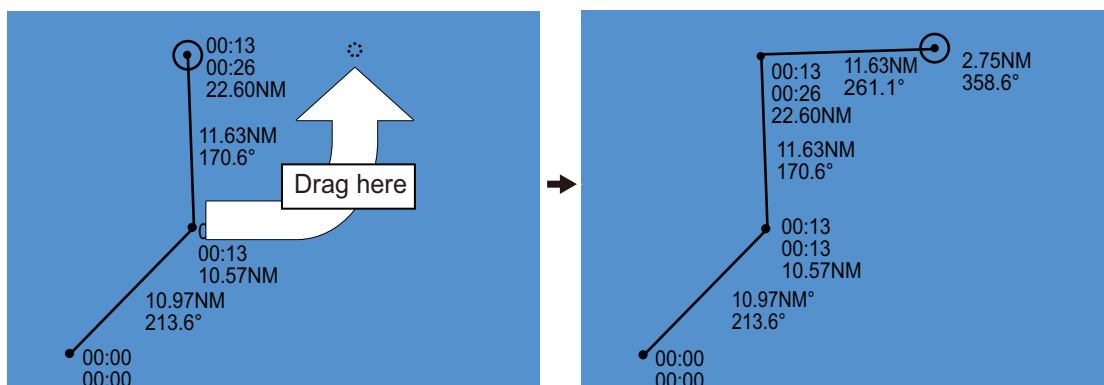

12.10.2 Usage characteristics, limitations

- The distance between points is shown to the hundredths decimal place up to 100 NM and to the tenths decimal place thereafter.
- A maximum of 50 points can be inserted, and the maximum measurable distance between two points is 240.0 NM.
- The TTG value is rounded to the nearest decimal place. Therefore, the displayed total TTG may not equal the sum of all the TTGs.
- The TTG is measurable to 99:00. If the TTG is higher, the TTG indication is ">99:00".
- The ship's speed must be at least 0.5 kn to calculate TTG.
- The divider cannot be used in latitude higher than 85°.
- In the split screen display, the divider is viewable on both the main and sub views, but is operable only on the main view.

12.10.3 How to deactivate and erase the divider

Get into the Voyage navigation or Voyage planning mode then right-click the screen to show the context-sensitive menu. Select [Clear Divider].

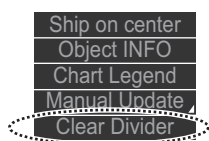

12.10.4 How to select range calculation method

The range calculation method for the EBL and VRM can be selected to Rhumbline or Great Circle. Do as follows to select a calculation method.

1. Open the menu, then select [NAV Tools] and [Geometry] to show the [Geometry] page.

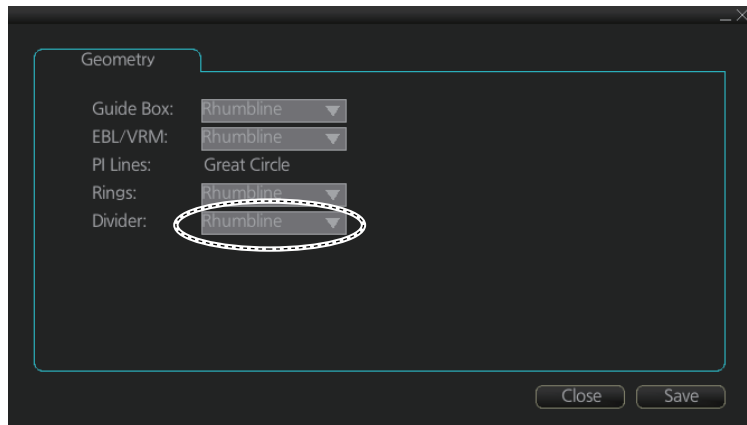

2. Select [Rhumbline] or [Great Circle] with the drop down list box for [Divider].
3. Click the [Save] button to save the setting, then click the close button to finish.

13. TRACKED TARGET (TT) FUNCTIONS

With connection to a radar, the movement of a maximum of 100 radar-tracked targets can be shown on the chart.

Note: The following conditions must be met to use the TT function:

- The TT data from the radar must be true bearing referenced.
- The speed source must be the same as that used by the radar. If they are different, the following occurs:
 - The TT symbol is shown but the vector is not shown.
 - The COG, SOG, CTW, STW indication is “missing”.

13.1 How to Show, Hide TT

Do the following to show or hide the TT.

1. Select the [TT/AIS] page from the [Overlay/NAV Tools] box.
2. Click the indication circled in the figure below to show [ON] or [OFF] as appropriate.

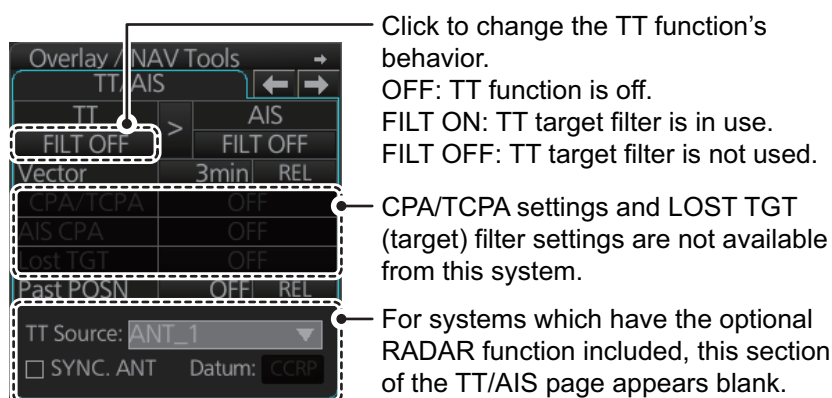







Note: The TT, AIS and radar displays can be hidden, when the radar overlay is active. Click the [CLEAR RADAR] button on the Status bar to hide those displays.



13.2 TT Symbols and TT Attributes

13.2.1 TT symbols

The symbols used in this equipment comply with IEC 62288.

Symbol	Default color	Name	Description
	Green	Past position point	Marks a past position of a TT.
	Green	Target under manual acquisition	A target acquired manually is initially indicated with a dashed circle.
	Green	Acquired target	Thick solid circle with vector indicating steady state tracking (within three minutes after acquisition).
	Green	Reference target	Used to calculate own ship's over-the-ground speed (echo-referenced speed) for ground stabilization.
	Green	Association target	Association TT is shown in AIS symbol and TT data.
	Green	Target selected	TT selected to show its data.

13.2.2 TT symbol color and size

The color and size of the TT symbol can be changed to your liking. Note that the color of the AIS symbol is also changed.

1. Click the [DISP], [SET] and [Symbol DISP] buttons on the InstantAccess bar to show the [Symbol Display] menu.
2. Click the [Targets] tab.

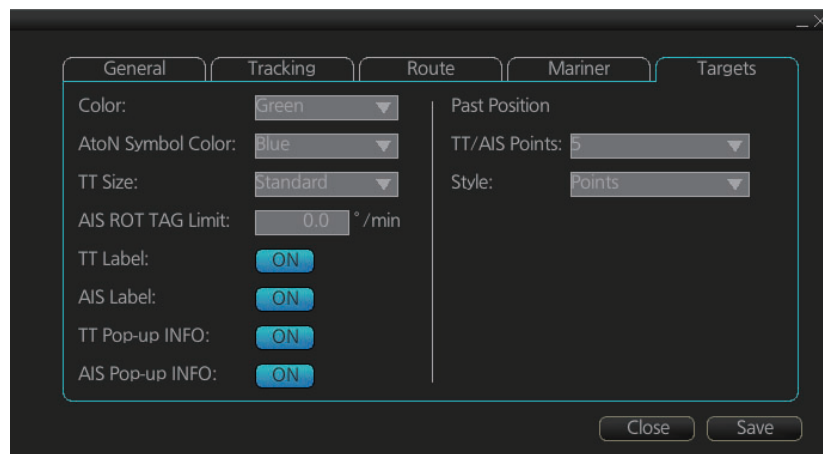

3. Select the color among, green, blue, black, magenta and brown, with the [Color] pull-down list.
4. Select the size from standard or small, with the [TT Size] pull-down list.

13.3 How to Filter TT Targets

When there is a large number of TT targets tracked at one time, the screen can become crowded. You can limit the TT targets display on your screen, based on distance from your vessel.

1. Open the main menu and select [TT/AIS] and [Setting].

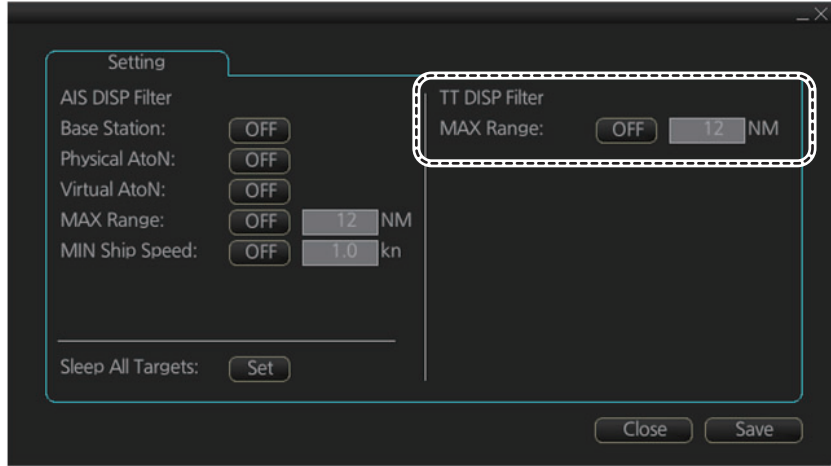

Note: You can also access the TT settings using the following methods:

- Select the [TT/AIS] page from the [Overlay/NAV Tools] box, right-click to show the context menu and select [Settings].
- From the TT/AIS window at the left-side of the [Overlay/NAV Tools] box, click the radio button. The TT/AIS window only appears when a page other than TT/AIS is displayed.

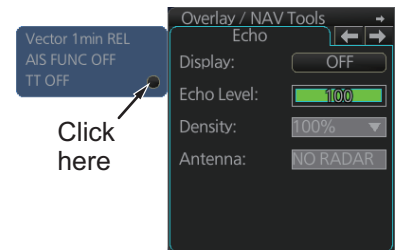

2. In the TT DISP Filter column, set the [MAX Range] as required. TT symbols beyond the range set here do not appear on the screen.
3. Click the [ON/OFF] button to show [ON].
4. Click [Save] to apply the settings, then click the [Close] button. The settings applied here affect the TT display when the TT display filter is set to [FILT ON].

Note: AIS and tracked target viewing limitations are as follows:

- AIS and tracked targets are displayed on top of chart 1:1,000,001 for S57 charts.
- AIS and tracked targets are displayed on top of chart 1:1,900,001 for ARCS charts. This allows display of AIS and tracked targets on top of the largest scale ocean charts (original scale 1:3,500,000) when they are zoomed to "overscale".

13.4 How to Set Vector Length and Vector Motion

Ground stabilization and sea stabilization

Target vectors can be ground stabilized or sea stabilized in the True Motion mode. To select speed over the ground or speed through the water data, open the [SPD] page from the [System Sensor Settings] or [Local System Settings] menu. Select [Bottom] for ground stabilization or [Water] for sea stabilization. The Vector mode indication shows the stabilization mode in the true motion as [T GND] or [T WAT].

Sea stabilization is a mode where own ship and all targets are referenced to the sea using a compass heading and single-axis log water speed inputs in the true motion mode. Ground stabilization is a mode where own ship and all targets are referenced to the ground using the ground track or set and drift inputs. If the accuracy seems unsatisfactory, enter set and drift corrections.

True vector

In the true motion mode, all fixed targets such as land, navigational marks and ships at anchor remain stationary on the radar overlay with vector length zero. But in the presence of wind and/or current, the vectors appear on fixed targets representing the reciprocal of set and drift affecting own ship unless set and drift values are properly entered.

In the true vector mode, there are two types of stabilization: ground stabilization (T GND) and sea stabilization (T WAT). The stabilization mode is automatically selected according to speed selection, as shown in the table below.

Speed selection	True vector mode
LOG(WT)	T WAT
LOG(BT)	T GND
POSN	T GND
REF	T GND
MAN	T GND
MAN w/set & drift	T GND

Relative vector

Relative vectors on targets that are not moving over the ground such as land, navigational marks and ships at anchor will represent the reciprocal of own ship's ground track. A target whose vector passes through own ship is on a collision course. (Dotted lines in the figure are for explanation only.)

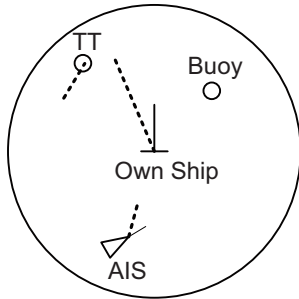

True vectors in ground stabilization

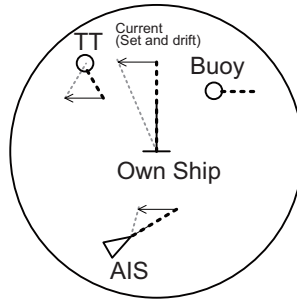

True vectors in sea stabilization

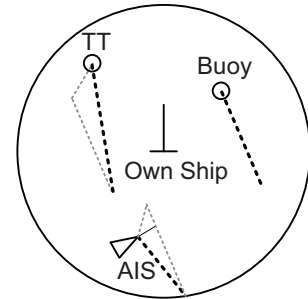

Relative vectors

To set the vector, click the vector time and vector reference indications in the [TT/AIS] page to set them.

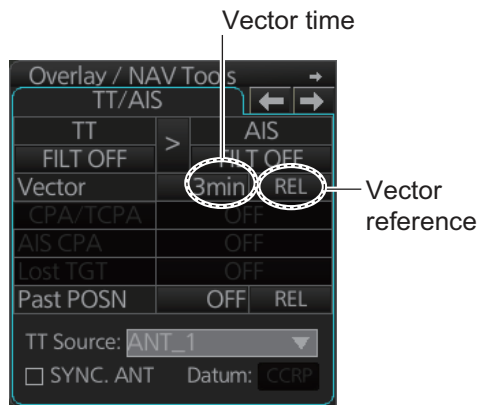

13.5 How to Display TT Data

13.5.1 How to display target data for individual TT

Click the TT for which you want to show its data.

TT data

To erase TT data from a data box, click the appropriate close data button.

The basic TT data display shows the following information:

- Target's number. The same number as the matching target on the radar. When a target is erased the number will not be reused until the power is re-set or more than 100 targets are acquired.
- Bearing (BRG) and distance (RNG) of the target from own ship
- True speed (SOG) and true course (COG) of the target
- CPA and TCPA. A negative TCPA value means that you have already passed the closest point and the TT is going away from own ship. CPA and TCPA value display range is determined by the received sentence, as shown below.
 - **CPA:** For TTM, the range is 0.00 NM to 999.99 NM; for TTD, the range is 0.00 NM to 163.82 NM.
 - **TCPA:** For TTM, the time is -99:59 to 99:59; for TTD, the time is -81:59 to 81:59.
- Bow Closest Range (BCR) and Bow Closest Time (BCT)

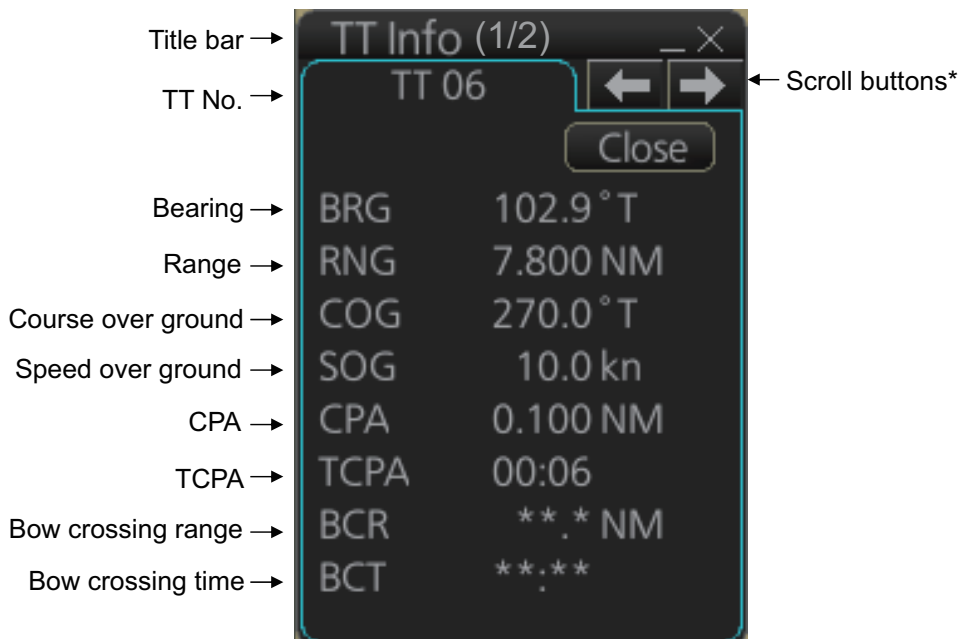

*: Scroll buttons appear only when there is more than one TT target's data displayed.

13.6 Displaying Past Positions of TT

The past position display shows equally time-spaced dots marking past positions of TT. A new dot is added at preset time intervals until the preset number is reached. If a TT changes its speed, the spacing will be uneven. If it changes course, its plotted course will not be a straight line.

You can set the plot interval and the presentation mode on the [TT/AIS] page in the [Overlay/NAV Tools] box, at the locations circled in the illustration below.

13.6.1 How to enable/disable the past position display, select past position reference

Select the [TT/AIS] page from the [Overlay/NAV Tools] box. Click the indications circled in the figure below to set the plot interval (or disable the display) and the past position reference (true or relative).

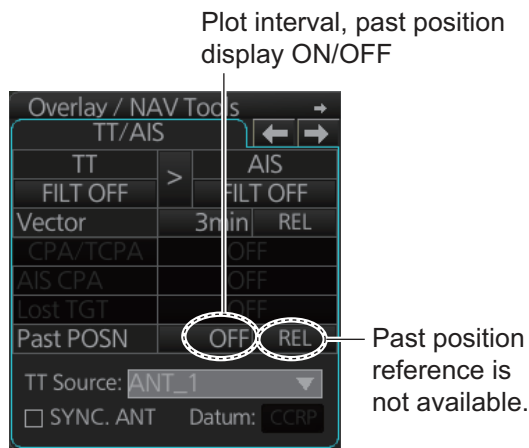

13.6.2 Past position point attributes

You can define past position point attributes for TT by points and style.

1. Click the [DISP], [SET] and [Symbol DISP] buttons on the InstantAccess bar to show the [Symbol Display] menu.
2. Click the [Targets] tab.

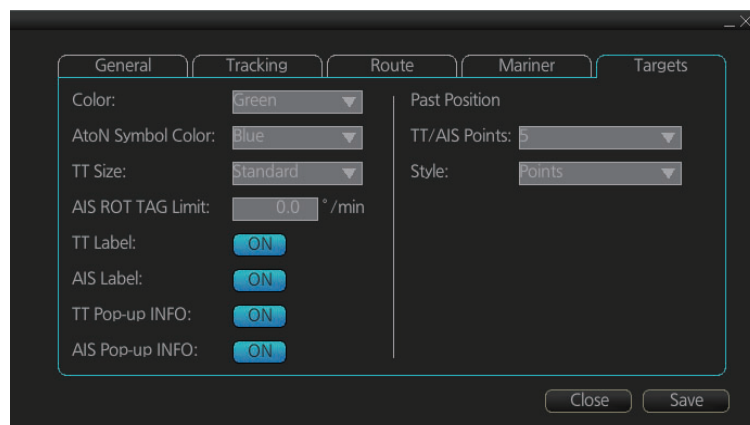

3. At [TT/AIS Points], select the number of points to show.
4. At [Style], select the style for the past position points. The choices are [Points] and [Points and Dots].

13.7 How to set the TT Source

13.7.1 TT source for configurations compliant with the latest regulations

When the connected radar is compliant with the latest regulations, the TT source can be set as one of the antennas (ANT_1 etc.) from the [TT Source] drop-down box.

Normally, select the radar antenna which is selected to display radar echoes as the TT source.

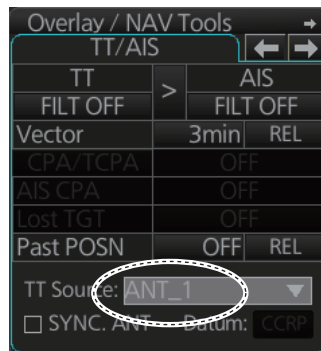

To automatically select the radar currently displaying radar echoes as the TT source, check the [SYNC. ANT] box on the [TT/AIS] page in the [Overlay/NAV Tools] box.

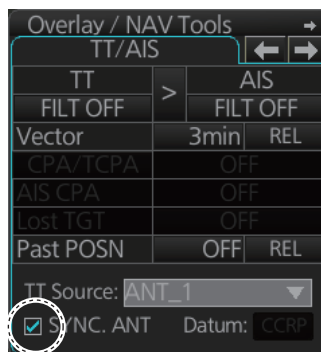

Notes on usage

- Antennas are displayed in numerical order, based on their SFID (Service Flow ID). For example, to use RAS001 select [ANT_1], to use RAS002 select [ANT_2].
- With [SYNC. ANT] checked, the antenna selected on the [Echo] page in the [Overlay/NAV Tools] box is marked with an asterisk.
- With [SYNC. ANT] checked, the checkmark is removed when a selection is made the drop-down box.
- [SYNC. ANT] is inoperative if no antenna is registered.
- The [Datum] button has no function when the connected radar is compliant with the latest regulations.

13.7.2 TT source for non-compliant configurations

For retro-fits and configurations where the connected radar does not comply with the latest regulations, you can select one of the antennas listed as “other antennas” (RA0201, etc.) as the TT source.

From the drop-down box, select the antenna SFID (set at installation) for the antenna to use as the TT source.

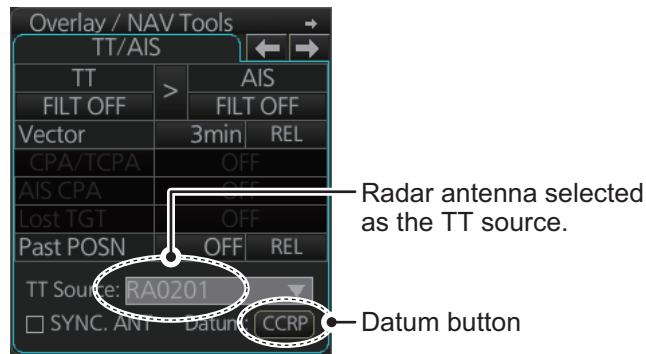

To automatically select the radar currently displaying radar echoes as the TT source, check the [SYNC. ANT] box on the [TT/AIS] page in the [Overlay/NAV Tools] box.

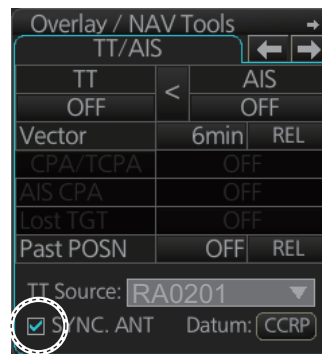

Notes on usage

- Radar antennas which are set as “other sensors at installation are displayed in numerical order, based on their SFID. For example RA0201, RA0202.
- When the radar selected is one of the “other sensors” antennas, the [Datum] button becomes active.
- The Datum button selects the reference position for use in the TTM sentence. Click the [Datum] button to select either [CCRP] or [ANT] (antenna).
- When [Datum] is set to [ANT], the indication appears in yellow color.
- With [SYNC. ANT] checked, the antenna selected on the [Echo] page in the [Overlay/NAV Tools] box is marked with an asterisk.
- With [SYNC. ANT] checked, the checkmark is removed when a selection is made the drop-down box.
- [SYNC. ANT] is inoperative if no antenna is registered.

13. TRACKED TARGET (TT) FUNCTIONS

This page is intentionally left blank.

14. AIS TARGET FUNCTIONS

14.1 Introduction

An AIS transponder can be connected to the ECDIS to display AIS targets received from an AIS transponder. The ECDIS can store up to 2,000 AIS targets in its storage buffer. When this buffer becomes full of AIS targets, Alert 533 "AIS Target Capacity 100%" is generated to alert you that the storage buffer is full. The storage buffer contains automatic dead reckoning for all AIS targets, which is based on reported Speed Over Ground (SOG), Course Over Ground (COG), Rate Of Turn (ROT) and heading. The storage buffer also contains calculation of range, bearing, CPA, TCPA, etc. The CPA and TCPA limits set for dangerous targets are common for TT and AIS targets.

This ECDIS can activate 500 AIS targets. The Alert 535 "AIS Target Activate 100%" appears when 500 AIS targets are activated.

The frequency for update of AIS transponder-sent data depends on speed and course of tracked AIS target. The table below shows the IMO standardized reporting rates for the AIS transponder. Based on the table below, the ECDIS defines which AIS targets are in tracking or lost. When you acknowledge the lost target alert, the AIS symbol is removed from the ECDIS display.

Type of Ship	IMO nominal reporting interval
Class A: Navigation status is "anchor" or "not under command" or "moored" or "aground", and SOG < 3 kn	3 min
Class A: Navigation status is "anchor" or "not under command" or "moored" or "aground", and SOG ≥ 3kn	10 s
Class A: 0kn ≤ SOG < 14kn	10 s
Class A: 14kn ≤ SOG ≤ 23kn	6 s
Class A: SOG > 23kn	2 s
Class B: "CS" SOG < 2kn	3 min
Class B: "CS" SOG ≥ 2kn	30 s
Class B: "SO" 0 kn ≤ SOG < 2kn	3 min
Class B: "SO" 2 kn ≤ SOG < 14kn	30 s
Class B: "SO" 14 kn ≤ SOG ≤ 23kn	15 s
Class B: "SO" SOG > 23kn	5 s
Class A and Class B: no SOG available	N/A
AIS SAR aircraft	10 s
AIS aid to navigation	3 min
AIS base station	10 s
AIS search and rescue transponder	N/A

An AIS transponder "sees" all ships fitted with an AIS transponder belonging to either Class A or Class B.

Additionally the AIS transponder receives messages other than messages from ships:

- AIS Base station
- AIS on airborne SAR craft
- AIS on ATON (AIS aid to navigation)

14. AIS TARGET FUNCTIONS











There can be several hundreds or several thousands AIS targets, and of those only a few will be significant for your ship. To remove unnecessary AIS targets from the EC-DIS display, the feature "active and sleeping AIS targets" is available. Initially any new AIS target received by an AIS transponder is not-active (= "sleeping"). Such non-active targets are shown with a small triangle. The operator can pick any AIS target and change it from non-active to active. Active AIS targets are shown with a large triangle with speed vector, headline, rot indicator, etc. Further, the operator can pick active AIS targets and change their status to non-active.





The feature "active and sleeping AIS targets" is very effective for focusing on only those AIS targets which need supervision.

14.2 AIS Symbols

Target symbols

AIS targets are marked with an appropriate symbol as shown in the table below.

Symbol	Default color	Name	Description
	Green	AIS tracked target past position point	Marks a past position of an AIS target.
	Green	Sleeping AIS target	Denote sleeping AIS symbol. (Lines are thinner than Active AIS symbol.)
	Green	Activated AIS target	Denote active AIS target, with vector. Lines are thicker than sleeping AIS symbol. Vessel name is shown (default setting).
	Green	Activated target, true scale symbol	Active AIS target with symbol shown in true scale.
	Blue	AIS SART	AIS SART target.
	Green	Selected AIS target	AIS and TT target declared as "association target". AIS symbol and AIS data are used.
	Green	Heading-turn indicator	Shows target's direction of turning.
	Green	SAR Aircraft	SAR (Search And Rescue) Aircraft
	Green	AIS base station	
	Green	AIS ATON	Aids to navigation

Symbol	Default color	Name	Description
	Green	AIS select symbol	Target selected to display its data.
	Green	SAR Vessel	SAR (Search And Rescue) vessel
	Green	Non HDG/COG sleeping AIS target	<p>The AIS symbol has dashed lines in the following instances:</p> <ul style="list-style-type: none"> • No STW or SOG. If speed data becomes invalid, all AIS symbols are shown with dashed lines. • If no speed data is received from a vessel, only the corresponding AIS symbol is shown in dashed lines. If no heading or course data is received from a vessel, the corresponding symbol is pointed upward on the display.
	Green	Non HDG/COG activated AIS target	

Note 1: The equipment continues to process AIS targets when the AIS feature is switched off. When the AIS is again turned on, symbols are immediately displayed.

Note 2: AIS symbols are momentarily erased after the screen is redrawn when the heading is changed from the Head-up mode.

Note 3: When no AIS data is received, the Alert 30380 "AIS COM Error" appears in the [Alert] box. Check the AIS transponder.

Note 4: The color of the AIS symbol can be changed on the [Targets] page of the [Symbol Display] menu.

Note 5: The table on the next page shows all the physical and virtual AIS ATON that may appear on the display.

AIS physical and virtual AtoN symbols

The table below shows all the AIS physical and AIS virtual AtoN symbols.

AIS Physical AtoN Symbol ¹	AIS Virtual AtoN Symbol	Default Color	Meaning
		Blue	Basic shape
		Blue	RACON
		Blue	Emergency wreck mark
		Blue	North cardinal mark
		Blue	East cardinal mark
		Blue	South cardinal mark
		Blue	West cardinal mark
		Blue	Port hand mark
		Blue	Starboard hand mark
		Blue	Isolated danger
			Safe water
		Blue	Special mark
OFF POSN 	—	Line: Yellow ² Char: Yellow ²	Off position (Displayed with yellow line and yellow text)
UNLIT 	UNLIT 	Line: Blue Char: Yellow ²	Light fail or at reduced range (Displayed with yellow text)
RACON ERR 	RACON ERR 	Line: Blue Char: Yellow ²	RACON error (Displayed with yellow text)
—	MISSING 	Line: Yellow ² Char: Yellow ²	Missing (Displayed with yellow dashed line and yellow text)

¹ The purpose indicator (for example, ⊙) appears at the top of a physical AtoN symbol. The indicator is always displayed in the radar mode, and when a symbol of this type is selected in the chart mode or chart radar mode. See the example below.

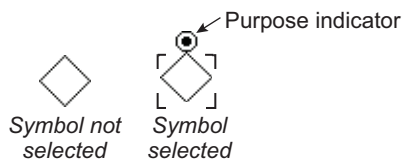

² Color not changeable.

14.3 Voyage Data

Before you embark on a voyage, set your navigation status, ETA, destination, draught and crew, on the [Voyage Data] page in the [NAV Status] menu.

1. Open the MENU then click both [NAV Status] in the [TT/AIS] menu and the [Voyage Data] tab.

Displayed according to connected AIS transponder

2. Click the [Navigational Status] drop-down list then select your navigational status, from the list below.
 - Underway using engine
 - At anchor
 - Not under command
 - Restricted maneuverability
 - Constrained by her draught
 - Moored
 - Aground
 - Engaged in fishing
 - Under way sailing
 - Reserved for high speed craft
 - Reserved for wing in ground
 - Reserved for future use (x3)
 - AIS-SART (active)
 - Not defined
3. Enter the number of persons onboard (0000-8191) at [Persons].
4. Enter ship's draught (0.0 - 25.5 (m)) at [MAX Draught].
5. Enter your ETA at [ETA], in UTC.
 - Day: two digits
 - Month: Three-character abbreviation
 - Year: Four digits
6. Enter your destination at [Destination], using a maximum of 20 characters.
7. Use the [Cargo Type] pull-down menu to specify the type of cargo your vessel is carrying,
 - All ships of this type
 - Carrying DG, HS, or MP, IMO hazard or pollutant category X
 - Carrying DG, HS, or MP, IMO hazard or pollutant category Y
 - Carrying DG, HS, or MP, IMO hazard or pollutant category Z
 - Carrying DG, HS, or MP, IMO hazard or pollutant category OS
 - Reserved for future use (x4)
 - No additional information
8. Click the [Save] button to register the settings. The settings are sent to the AIS transponder.

14.4 How to Show, Hide AIS Targets

Targets that are being tracked by an AIS transponder can also be displayed on the ECDIS display. To show or hide AIS target, select the [TT/AIS] page from the [Overlay/NAV Tools] box. Click the indication circled in the figure below to display [DISP OFF], [DISP FILT], [DISP ALL] or [FUNC OFF].

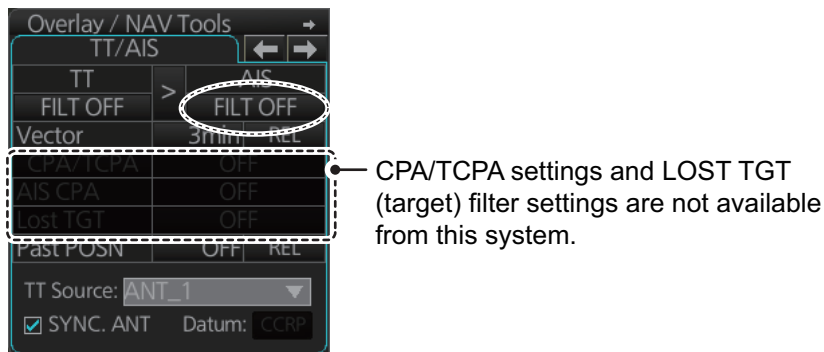

DISP OFF: Turns off the AIS display. (Tracking continues internally.)

FILT OFF: Shows all AIS targets within the range set.

FILT ON: Targets are shown according to the AIS DISP filter settings, on the [TT/AIS] menu.

FUNC OFF: Deactivates the AIS function

To deactivate the AIS function, click the location circled above to show [FUNC OFF]. Then, processing of AIS targets is stopped. To turn on the AIS function, click the area to show [FILT OFF], [FILT ON] or [OFF].

Note: The AIS, TT and radar displays can be hidden, when the radar overlay is active. Click the [CLEAR RADAR] button on the Status bar to hide those displays.



14.5 How to Filter AIS Targets

1. Right-click [AIS] on the [TT/AIS] page in the [Overlay/NAV Tools box], select [Setting] and open the [Setting] page.

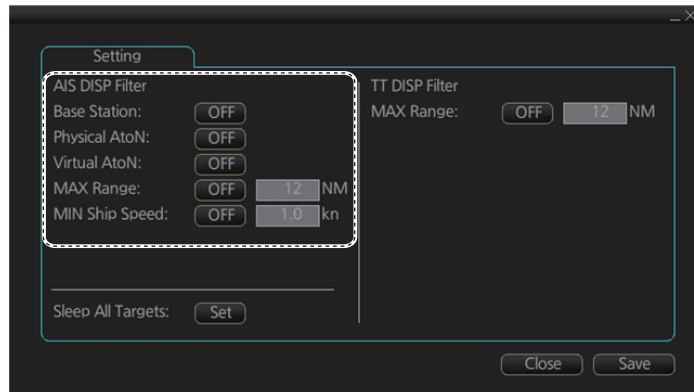

Note: The Setting page can also be opened as follows:

- MENU→[TT/AIS]→[Setting]
- Click the radio button on the window that appears to the right of the [Overlay/NAV Tools box], when a page other than the [TT/AIS] page is selected.

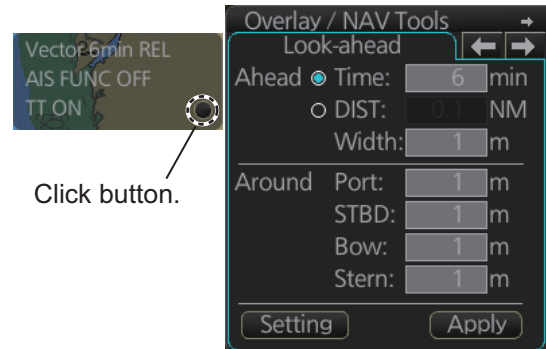

2. In the [AIS DISP Filter] window, set each item referring to the descriptions below.
 - **Base Station:** Click button to show or hide base stations.
 - **Physical AtoN:** Click button to show or hide physical AtoN.
 - **Virtual AtoN:** Click button to show or hide virtual AtoN.
 - **MAX Range:** Click button, then set maximum range. Any AIS target not within the range set is not shown on the display.
 - **MIN Ship Speed:** Click button, then set minimum speed. Any AIS target slower than set here is not shown on the display.
3. Click the [Save] button to save settings. Click the [Close] button to close the dialog box. These settings are effective when the AIS display setting is [FILT ON]. The AIS display setting [OFF] shows all AIS targets (same as [FILT OFF]).

Note: AIS and tracked target viewing limitations are as follows:

- AIS and tracked targets are displayed on top of chart 1:1,000,001 for S57 charts.
- AIS and tracked targets are displayed on top of chart 1:1,900,001 for ARCS charts. This allows display of AIS and tracked targets on top of the largest scale ocean charts (original scale 1:3,500,000) when they are zoomed to "overscale".

14.6 Activated Targets

When you change a sleeping target to an activated target, the target's course and speed are indicated with a vector. The vector can be monitored to find vessel movement.

To activate a sleeping target, put the cursor on the target then press the **ACQ/ACT** key.

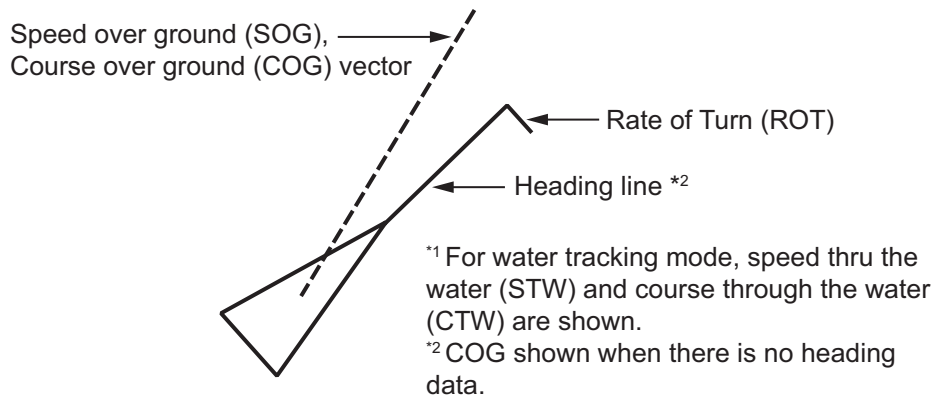

When the screen gets full of activated targets, it is difficult to discriminate the radar display and tracked targets. When this occurs, sleep some activated targets to clear up the screen.

14.7 Sleeping Targets

14.7.1 How to sleep an activated target

Put the cursor on an activated target, then click the **TARGET/CANCEL** key.

14.7.2 How to sleep all activated targets

1. Open the [Overlay/NAV Tools] box, the right click [AIS].

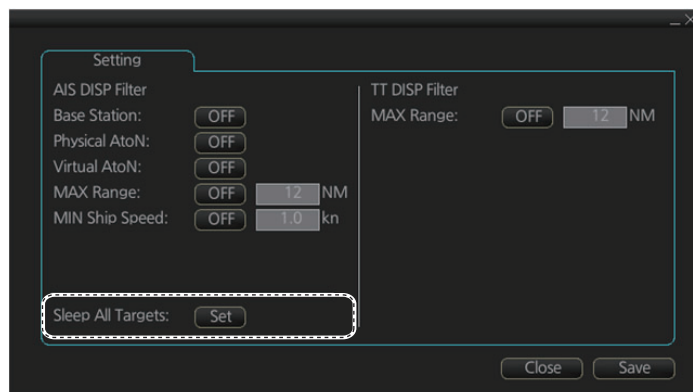

2. Click the [Set] button of [Sleep All Targets].
3. Click the [Save] button to save settings. Click the [Close] button to close the dialog box.

14.8 How to Display AIS Target Data

Standard data

Put the cursor on an activated target then push the left button.

Note: CPA/TCPA information appears in the AIS info when the following two requirements are met. If the requirements are not met, CPA/TCPA appears as “*”.

- AIS target is activated at the connected radar
- The TTD sentence for the selected target is received from the connected radar

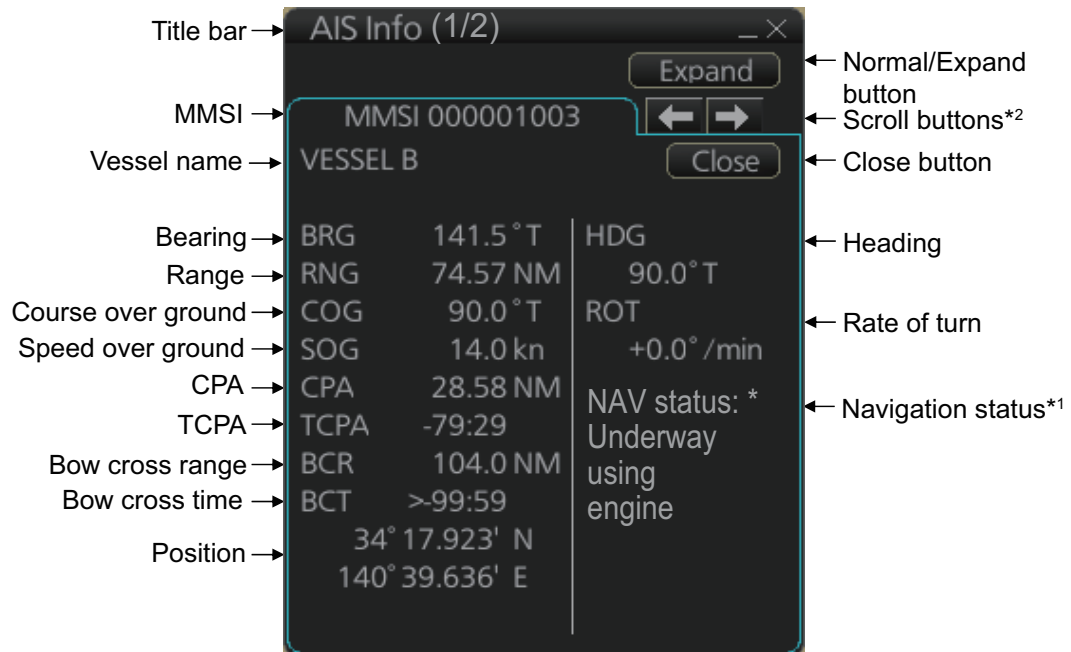

*1: [Altitude] appears when the selected target is an AIS SART aircraft.

*2: Scroll buttons appear only when there is more than one AIS target's data displayed.

Expanded data

Put the cursor on an activated target then push the left button. Click the [Expand] button on the [AIS Info] box to show expanded AIS data.

Note: CPA/TCPA information appears in the AIS info when the following two requirements are met. If the requirements are not met, CPA/TCPA appears as “*”.

- AIS target is activated at the connected radar
- The TTD sentence for the selected target is received from the connected radar

The screenshot shows a window titled "AIS Info (1/2)" with various data fields and control buttons. The fields are organized into two columns. The left column contains labels for various data points, and the right column contains the corresponding data values. Control buttons are located at the top right of the window.

Field Label	Data Value
Title bar	AIS Info (1/2)
MMSI	MMSI 000001003
Vessel name	VESSEL B
Bearing	BRG 141.6 ° T
Range	RNG 74.82 NM
Course over ground	COG 90.0 ° T
Speed over ground	SOG 14.0 kn
CPA	CPA 33.86 NM
TCPA	TCPA -78:41
Bow cross range	BCR 121.1 NM
Bow cross time	BCT >99:59
Position	34° 17.922' N 140° 39.777' E
Position sensor	POS sensor: GPS
Position sensor accuracy (HIGH, LOW)	POS ACC.: HIGH
Call sign	Call sign: CALL2
IMO No.	IMO No.: IMO2222222
Length	Length: 300m
Width	Width: 11m
Draught	Ship draught: 12.2m
Destination	Destination: DESTINATION2
ETA	ETA: 31/DEC 23:59
AIS version no.	AIS version: 1
Ship & Cargo type	Ship and Cargo Type: Tanker(s) All ships of this type
Association setting	Association: OFF

Additional controls and data points shown in the screenshot:

- Normal/Expand button (Normal)
- Scroll buttons (Left and Right arrows)
- Close button (Close)
- Heading (HDG 90.0° T)
- Rate of turn (ROT +0.0° /min)
- Navigation status (NAV status: Underway using engine)

*1: [Altitude] appears when the selected target is an AIS SART aircraft.

*2: Scroll buttons appear only when there is more than one AIS target's data displayed.

14.9 Vector Length, Vector Stabilization in True Motion Mode

Ground stabilization and sea stabilization

Target vectors can be ground stabilized or sea stabilized in the True Motion mode. To select speed over the ground or speed through the water data, open the [SPD] page from the [System Sensor Settings] or [Local System Settings] menu. Select [Bottom] for ground stabilization or [Water] for sea stabilization. The Vector mode indication shows the stabilization mode in the true motion as [T GND] or [T WAT].

Sea stabilization is a mode where own ship and all targets are referenced to the sea using a compass heading and single-axis log water speed inputs in the true motion mode. Ground stabilization is a mode where own ship and all targets are referenced to the ground using the ground track or set and drift inputs. If the accuracy seems unsatisfactory, enter set and drift corrections.

True vector

In the true motion mode, all fixed targets such as land, navigational marks and ships at anchor remain stationary on the radar overlay with vector length zero. But in the presence of wind and/or current, the vectors appear on fixed targets representing the reciprocal of set and drift affecting own ship unless set and drift values are properly entered.

In the true vector mode, there are two types of stabilization: ground stabilization (T GND) and sea stabilization (T WAT). The stabilization mode is automatically selected according to speed selection, as shown in the table on the next page. Manual selection is available with [Stabilization Mode] in the [SPD] page: [Bottom], [T GND], [Water], [T WAT].

Speed selection	True vector mode
LOG (WT)	T WAT
LOG (BT)	T GND
POSN	T GND
REF	T GND
MAN	T WAT
MAN w/set & drift	T GND

Relative vector

Relative vectors on targets that are not moving over the ground such as land, navigational marks and ships at anchor will represent the reciprocal of own ship's ground track. A target whose vector passes through own ship is on a collision course.

Vector time and vector reference can be set from the [TT/AIS] page in the [Overlay/NAV Tools] box. Click the vector length and vector reference indications to set them.

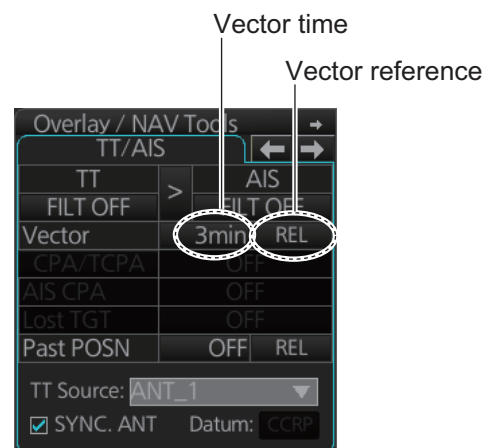

14.10 How to Display AIS Target Past Positions

The past position display shows equally time-spaced dots marking past positions of activated AIS targets. A new dot is added at preset time intervals until the preset number is reached. If a target changes its speed, the spacing will be uneven. If it changes course, its plotted course will not be a straight line.

Past Positions (or the length of trace) and presentation mode can be set on the information area, as shown in the next section.

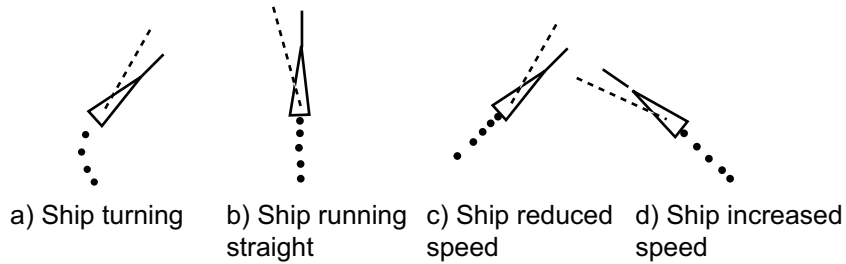

14.10.1 How to enable/disable the past position display, set past position reference

Select the [TT/AIS] page from the [Overlay/NAV Tools] box. Click the indications circled in the figure at right to set the plot interval (or disable the display) and the past position bearing reference (true or relative).

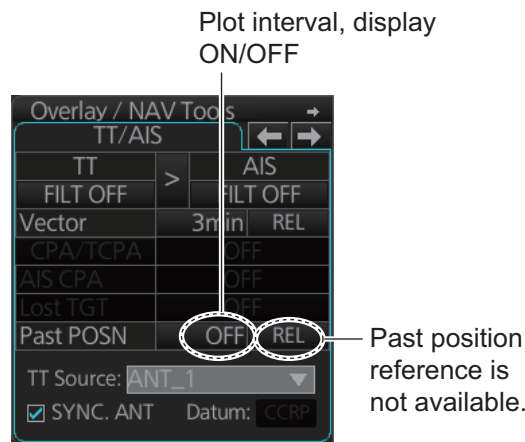

Note: The number of past position points and points style can be selected on the [Targets] page. See section 13.6.2.

14.11 TT, AIS Target Association

A vessel that carries an AIS transponder is marked on the display with both an AIS-symbol (based on GPS position) and a TT symbol (radar-detected target). To avoid the presentation of two target symbols for the same physical target, use the "association" function. If target data from both AIS and TT are available and if the association criteria are fulfilled, either the AIS or TT symbol is presented according to the association method selected. Association will not happen between AIS and TT if the AIS target is sleeping.

The target data to have priority is controlled from the [TT/AIS] page in the [Overlay/NAV Tools] box. Click the arrow circled in the figure below to select target data priority;



AIS data priority

TT data priority

Note: The association data priority can also be selected from a context menu. Right-click the arrow on the TT/AIS page to display the window shown right.



14.12 How to Display Own Ship Data

You can see own ship's data on the [Own Ship] page in the [NAV Status] menu. Open the menu then click both [NAV Status] in the [TT/AIS] menu and the [Own Ship] tab.

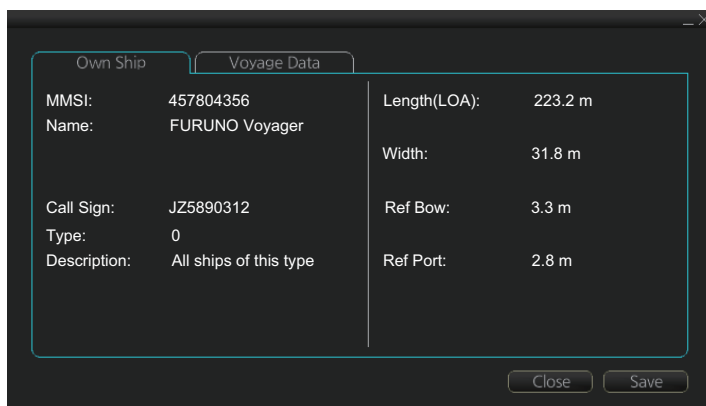

14. AIS TARGET FUNCTIONS

This page is intentionally left blank.

15. AIS SAFETY, NAVTEX MESSAGES

15.1 AIS Safety Messages

You can send and receive messages via the VHF link, to a specified destination (MMSI) or all AIS-equipped ships within communication range of your ship. Messages can be sent to warn of safety of navigation, for example, an iceberg sighted. Routine messages are also permitted. Short safety-related messages are only an additional means to broadcast safety information. They do not remove the requirements of the GMDSS.

15.1.1 How to send an AIS safety message

Note: Display the software keyboard ([DISP] button, [], [ON] on the InstantAccess bar) before starting this procedure.



1. In the Voyage navigation mode, click the [MSG] and [Safety MSG] buttons on the InstantAccess bar to show the [Message] dialog box.

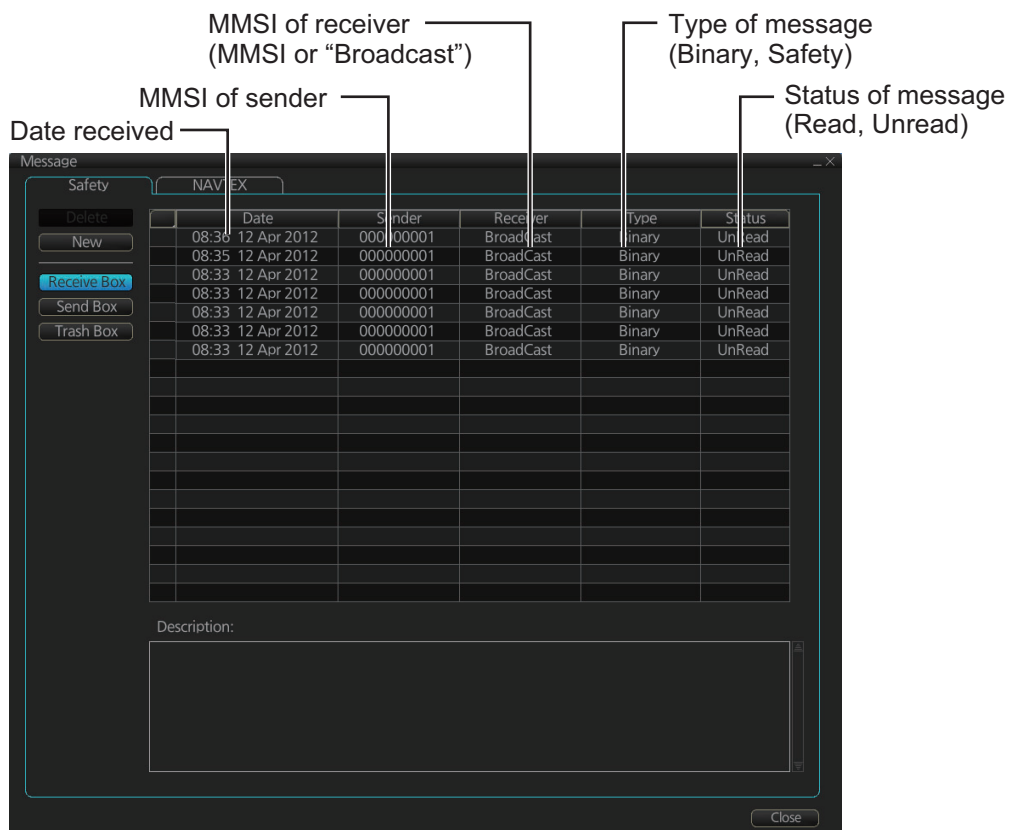

Date	Sender	Receiver	Type	Status
08:36 12 Apr 2012	00000001	BroadCast	Binary	UnRead
08:35 12 Apr 2012	00000001	BroadCast	Binary	UnRead
08:33 12 Apr 2012	00000001	BroadCast	Binary	UnRead
08:33 12 Apr 2012	00000001	BroadCast	Binary	UnRead
08:33 12 Apr 2012	00000001	BroadCast	Binary	UnRead
08:33 12 Apr 2012	00000001	BroadCast	Binary	UnRead

15. AIS SAFETY, NAVTEX MESSAGES

2. Click the [New] button.
3. At [Send to], select where to send the message. Select [Broadcast] to send the message to all AIS-equipped ships within communication range, or select [MMSI] and enter the MMSI of the ship where to send the message.
4. At [Type], select the type of message, [Safety] or [Binary] (routine).
5. At [Channel], select the channel to use to send the message.
6. At [Description], enter the text of your message. The no. of characters available depends on the type of message.
Safety message broadcast: 161 characters
Binary message broadcast: 156 characters
Safety message addressed to MMSI: 156 characters
Binary message addressed to MMSI: 151characters
7. Click the [Send] button to send the message.

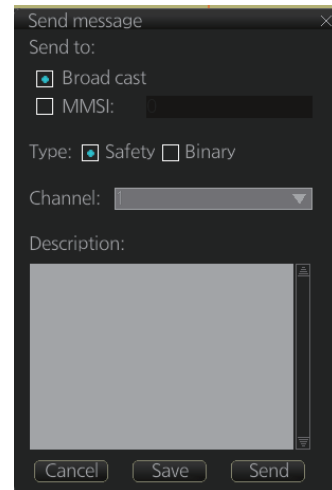

15.1.2 How to display received and sent AIS safety messages

When an AIS message is received, the alert 539 “AIS Message Received” appears. Do the following to view the message.

How to display the Message dialog box, view a message

Click the [MSG] and [Safety MSG] buttons on the InstantAccess bar. Click the [Receive Box] or [Send Box] button as appropriate. Click a message to view its contents.

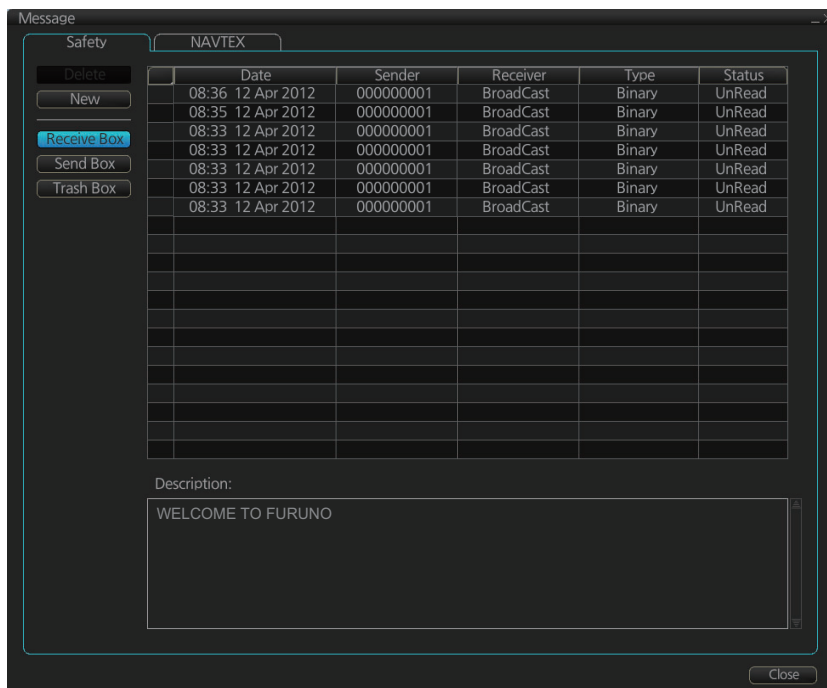

15.1.3 How to delete a received or sent message

How to delete a sent or received message

1. Click the [Receive Box] or [Send Box] as appropriate.
2. Click the box that is before the date to show a check mark. (All messages can be checked or unchecked with the context-sensitive menu. Right-click the box to the left of [Date] then select [Select All] or [Deselect All] as applicable.)
3. Click the [Delete] button.

How to delete received or sent messages permanently

1. Click the [Trash Box] button.
2. Click the box that is before the date to show a check mark. (All messages can be checked or unchecked with the context-sensitive menu. Right-click the box to the left of [Date] then select [Select All] or [Deselect All] as applicable.)
3. Click the [Delete] button.

Note: A large amount of messages may take some time to delete.

15.2 Navtex Messages

Navtex (Navigational Telex) is an international automated medium frequency direct-printing service for delivery of navigational and meteorological warnings and forecasts, as well as urgent marine safety information to ships.

Navtex messages can be received and read.

The [Receive Box] can store up to 500 messages. When the [Receive Box] is full and a new message is received, the system automatically deletes messages, in order, from the oldest message.

Note: If the message "Database access failure occurred. NAVTEX messages cannot be received." appears, your Navtex database may be corrupted. Consult your dealer for advice.

15.2.1 How to receive Navtex messages

To display a received NAVTEX message, do the following:

1. In Voyage navigation mode, click the [MSG] and [NAVTEX MSG] buttons on the InstantAccess bar™.
2. Click the message to view. The text of the message appears in the [Description] box.

Message protection status:
P = Protected
Blank = Un-protected

Date received

Frequency/Message ID

Type of message

Message status:
Read or Unread

Selection column

Where the selected message has a date range, the dates are displayed here.

Where coordinates are included in the message, the latitude and longitude are displayed here. The chart is also appropriately marked with the MSI marker.

Date	Code	Message Type	Status
17:01 28 Jun 2016	518kHz/GA50	Navigational warning	Read
17:00 28 Jun 2016	518kHz/GA53	Navigational warning	Read
15:07 28 Jun 2016	518kHz/GB88	Meteorological warning	Read
15:04 28 Jun 2016	518kHz/HB73	Meteorological warning	Read
17:27 27 Jun 2016	518kHz/IA77	Navigational warning	Read
17:25 27 Jun 2016	518kHz/IA88	Navigational warning	Read
17:12 27 Jun 2016	518kHz/HA37	Navigational warning	Read
17:05 27 Jun 2016	518kHz/GA47	Navigational warning	Read

Latitude	Longitude
1 34 ° 32.000' N	135 ° 05.000' E

Date Range(UTC):
From 30 Jun 2016 to 30 Jun 2016

281700 UTC JUN 16
JAPAN NAVTEX N.W. NR 1357/16
OKINAWA SHIMA, EAST SOUTHEASTWARD.
GUNNERY, 2100Z TO 0900Z COMMENCING DAILY

- You can filter the displayed messages.
 - To filter by date:** Enter the date range for displayed messages in the [Date Range(UTC)] input area. To clear the filter, click the [Clear] button. Check the Filter by Date box to activate the filter.
 - To filter by distance:** Check the [Filter by Distance] box to activate the [Distance from Own Ship] input area. Enter the appropriate distance (setting range: 1 to 100 NM).
- To protect a message, or remove the protection, click the protection status column for the message. When removing protection, the confirmation window shown below appears. Select [Yes] or [No] as appropriate.
 - Note:** You can protect up to 50 messages. When you try to protect more than 50 messages, the message shown below appears.

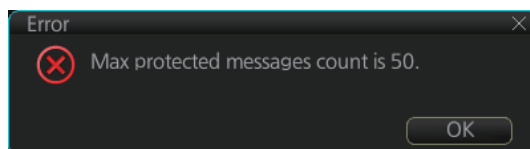
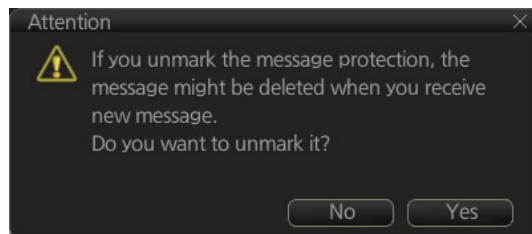

- You can check the settings for the Navtex receiver (if connected). Click the [Receiver] button to show the settings.

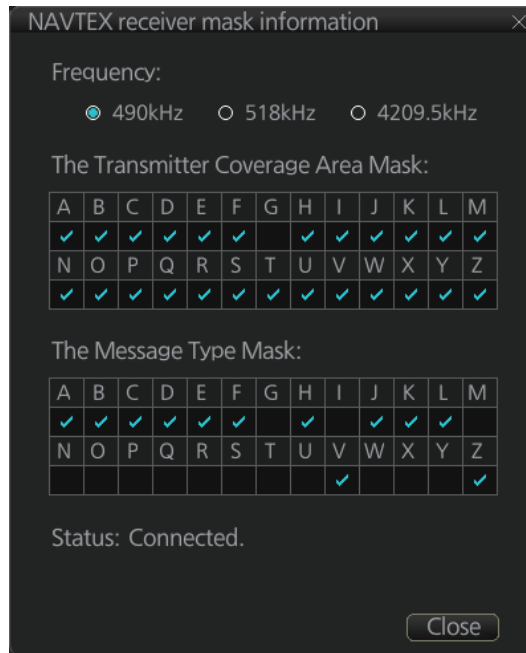

15.2.2 How to delete received Navtex messages

Note: A large amount of messages may take some time to delete.

How to delete received Navtex messages

- Click the [MSG] and [NAVTEX MSG] buttons on the InstantAccess bar™.
- Click the [Receive Box] button.
- Click the selection column (indicated in the figure at section 15.2.1) to show a check mark in the box. (All messages can be checked or unchecked with the context-sensitive menu. Right-click the top box to the left of [P] then select [Select All] or [Deselect All] as applicable.)
- Click the [Delete] button. The selected message is sent to the [Trash Box]. The [Trash Box] can hold up to 200 messages.

Note: If a protected message is selected for deletion, the confirmation message shown to the right appears. Click [Yes] to delete the protected message or [No] to cancel deletion.

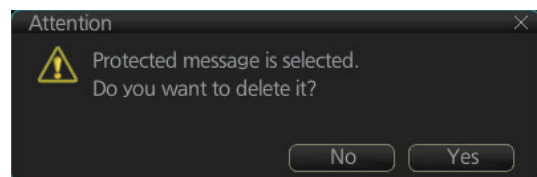

How to deleted received Navtex messages permanently

- Click the [MSG] and [NAVTEX MSG] buttons on the InstantAccess bar™.
- Click the [Trash Box] button.
- Click the selection column (indicated in the figure at section 15.2.1) to show a check mark in the box. (All messages can be checked or unchecked with the context-sensitive menu. Right-click the box to the left of [Date] then select [Select All] or [Deselect All] as applicable.)
- Click the [Delete] button.

This page is intentionally left blank.

16. RADAR OVERLAY

16.1 Introduction

The radar overlay has the radar echo image overlaid on the ECDIS chart display, in the Voyage navigation mode. The radar video signal can be fed from a FURUNO radar connected to the ECDIS via LAN, or via the optional Radar Connection Box (RCB-002) in the case of a FURUNO radar or a non-FURUNO radar.



This ECDIS has many features to support exact match in scale and orientation of the chart and radar echo image. Exact match of the radar echo image and chart is an essential security feature. If the radar echo image and the chart display match, then the mariner can rely on what he sees and the mariner also gets a very good confirmation that his navigation sensors (such as gyro and position fixing equipment) operate properly and accurately. However, if the mariner is unable to achieve exact match, it is a very strong indication that something is wrong and he should not rely on what he sees.

If a radar echo and a chart object occupy the same geographical position, the one selected as having priority (with [Priority] on the [Echo] page in the [Overlay/NAV Tools] box) is displayed.

Selected scale of displayed chart also defines scale of radar overlay. When you change the chart scale, the scale of the radar overlay is automatically changed. The table below shows the standard scale and equivalent radar range.

Radar range (nm)	Standard scale	Radar range (nm)	Standard scale
0.25	1:4,000	6	1:90,000
0.5	1:8,000	12	1:180,000
0.75	1:12,000	24	1:350,000
1.5	1:22,000	48	1:700,000
3	1:45,000	96	1:1,500,000

16.2 How to Activate, Setup the Radar Overlay

Radar echoes can be output to the ECDIS and shown on its display. Like details on S57 charts, the radar overlay can be displayed or removed from the chart display. The transparency of the echo display can be set from the [Echo] page in the [Overlay/NAV Tools] box. To activate and setup the radar overlay, do the following:

1. Select the [Echo] page from the [Overlay/NAV Tools] box.
2. Click the [ON/OFF] button at [Display] to show [ON] (radar overlay ON) to activate the overlay. "Status: OK" appears under [Antenna] if the radar signal is being received. "Status: No Data" is displayed if there is no radar signal.

Note: The TT display, together with the AIS and radar displays, can also be hidden by clicking [CLEAR RADAR] on the Status bar.

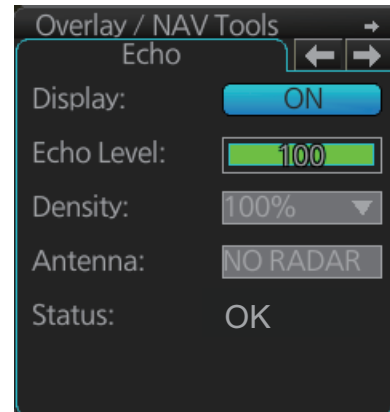

3. [Echo Level] adjusts the sensitivity of the radar picture. To adjust, put the cursor on the slider bar and roll the scrollwheel.
4. [Density] controls the "see through" behavior of the radar overlay. [100%] overlays the radar echo on the chart without modification. "25%" displays radar echoes somewhat faintly, and "75%" displays radar echoes very faintly. It is recommended to use 25% or 50% when navigating narrow channels, so as not to conceal landmasses.
5. [Priority] sets the priority between chart object and radar echo when an object and an echo share the same position. Select the one that is to have priority.
6. Click the [Antenna] drop-down list to select the radar that is to feed radar echoes. If the antenna is not changed within approx. 30 seconds, try to reselect it.

16.3 How to Adjust the Radar Signal Fed From the Radar Connection Box

Follow the procedure below to set up the radar overlay for the radar connected via the Radar Connection Box. These adjustments are not necessary for the radar which feeds the radar signal via LAN.

1. Select the [RCB Common] page from the [Overlay/NAV Tools] box.

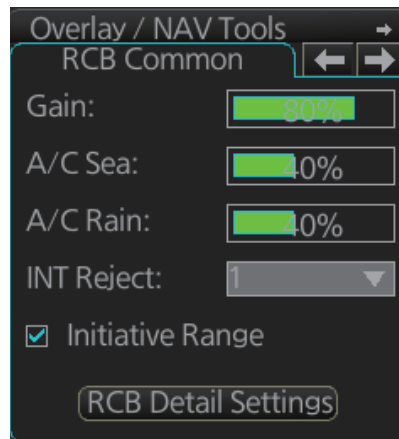

2. [Gain] adjusts the strength of the radar signal. Adjust the gain so that the background noise is just visible on the screen. If the gain level is too low, weak echoes may be missed. On the other hand, if the gain level is too high, the strong background noise can hide weak targets.

Note: This setting does not affect the gain set on the radar.

3. [A/C Sea] reduces sea clutter, which is caused by strong reflections from the sea surface and occurs around own ship in bad weather. Strong sea clutter can prevent identification of targets on the screen. Set the level so that weak sea clutter appears on the screen. Do not over-adjust the control - approaching targets can be missed. Set the level at 0 (OFF) if there is no sea clutter on the display to prevent loss of small targets.

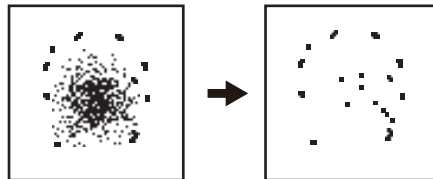

Sea clutter at the center of the screen.

Sea clutter suppressed.

4. [A/C Rain] reduces rain clutter, which is caused by rain and snow returns. When the rain clutter hides targets, use the [A/C Rain] to reduce the rain clutter. The control operates like the sea clutter control but it is effective not only on near ranges but longer ranges as well. The higher the setting, the greater the rain clutter reduction.

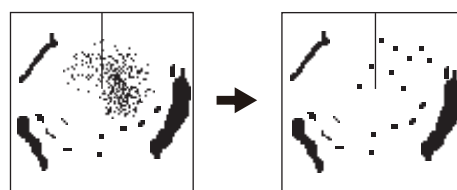

Rain clutter (starboard direction)

A/C Rain adjusted; rain clutter suppressed.

16. RADAR OVERLAY

5. [INT Reject] reduces radar interference. Radar interference can occur when your vessel is in the area of another radar that operates in the same frequency band (3 GHz) as own radar. The interference is seen on the screen as a number of bright spikes either in irregular pattern or as dotted lines that extend from the center of the edge of the picture. When this type of interference appears on the screen, use the interference rejector.

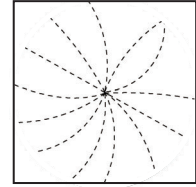

Four settings are available, [1], [2], [3] and [OFF]. The higher the setting the greater the degree of interference rejection. Turn the rejector off when no interference is present, so as not to miss small targets.

6. [Initiative Range], when checked, sends the current ECDIS range to the RCB. For example, the current ECDIS range is 4 NM. Then, "4 NM" is sent to the RCB and the RCB sends echo data within that range to the ECDIS. If multiple ECDIS units are in the system, only one ECDIS can have [Initiative Range] checked, so all ECDIS displays are synced. If unchecked, the radar sends echo data corresponding to the previously set ECDIS range.
7. Click the [RCB Detail Settings] button to show the [RCB Detail Settings] dialog box. Set each item as shown on the next page. The dialog box has two divisions, [Common] and [Individual]. The [Common] settings apply to all the radars connected to the ECDIS via the Radar Connection Box. The [Individual] settings apply to the radar currently feeding echo data to the ECDIS via the Radar Connection Box.

Note: For FURUNO radars, it is recommended to use the settings set on the radar in order to match the radar overlay picture with the radar picture.

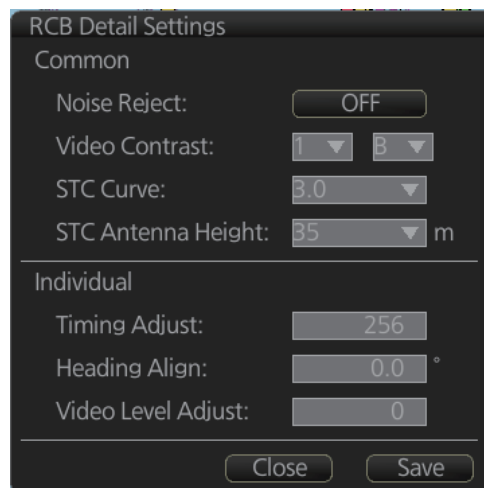

RCB Detail Settings	
Common	
Noise Reject:	OFF
Video Contrast:	1 ▼ B ▼
STC Curve:	3.0 ▼
STC Antenna Height:	35 ▼ m
Individual	
Timing Adjust:	256
Heading Align:	0.0 °
Video Level Adjust:	0
Close Save	

- 1) [Noise Reject] suppresses white noise.
- 2) [Video Contrast] adjusts the video dynamic range and curve. Refer to the figure below for settings and results.

The gain at the center of the signal strength is low, suitable for distinguishing targets from sea and rain clutters.

The gain at the center of the signal strength is high, making it difficult to distinguish targets from sea and rain clutters.

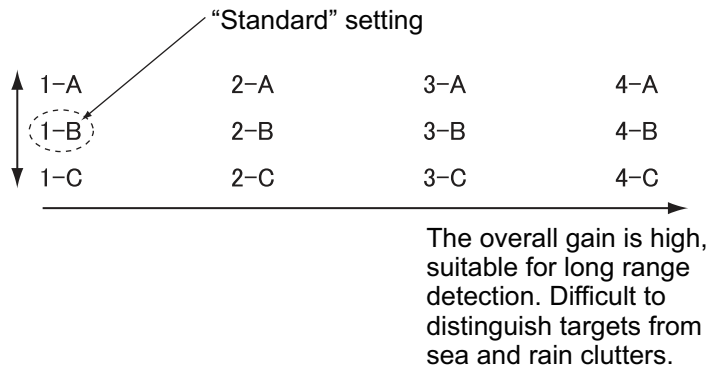

- 3) [STC Curve]: If sea clutter is not sufficiently suppressed with the [A/C Sea] control on the [RCB Common] page, try to adjust the STC curve. The choices are 2.5, 3.0, 3.5 and 4.2. The higher the number the greater the STC effect.
- 4) [STC Antenna Height] sets the antenna height (m) above sea level. The choices are 5, 7.5, 10, 15, 20, 25, 30, 35, 40, 45, and [more 45].
- 5) If a target appears pushed inward or pushed outward (when it should be straight), or targets displayed near the center of the screen are not at their correct distances, adjust [Timing Adjust] to straighten the target.

Note: Improper adjustment causes echoes to be displayed weakly.

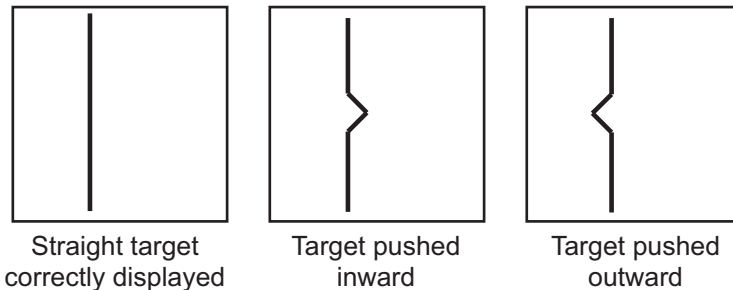

- 1) Transmit the radar and set the chart scale on the ECDIS to 1:4,000.
- 2) Adjust the gain, sea clutter, etc. to display the radar image properly.
- 3) Find a target on the ECDIS that should be displayed straightly, like a pier or jetty.
- 4) While monitoring the target, enter a figure in [Timing Adjust] that straightens the target.

16. RADAR OVERLAY

- 6) [Heading Align]: Some positioning error may occur when the antenna unit is installed. This error can be compensated from the ECDIS.

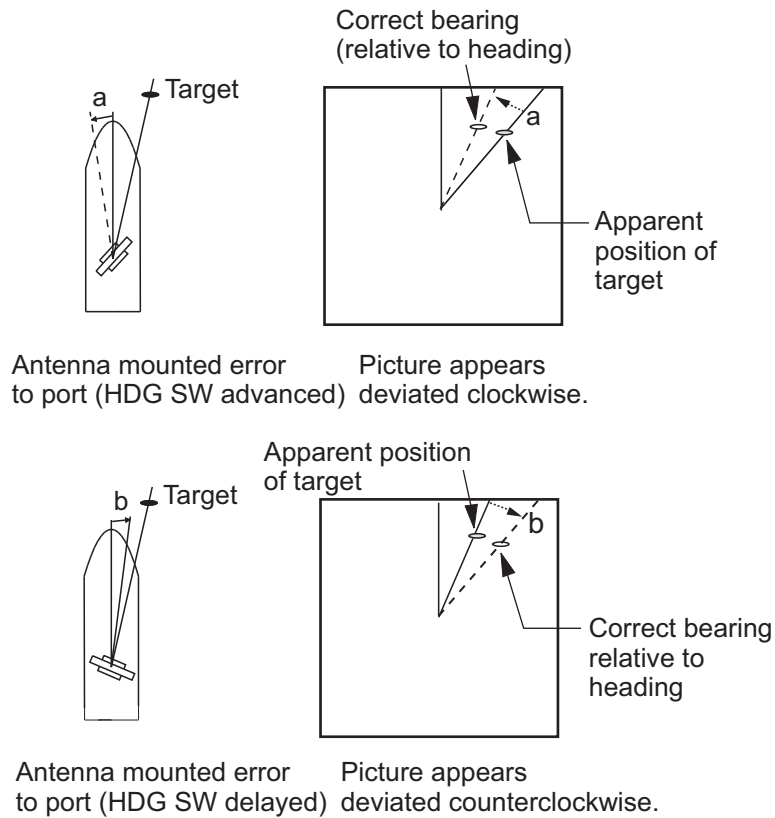

- 1) Set the chart scale on the ECDIS between 1:2,000 and 1:4,000. Select a target echo which is near the radar heading line on the ECDIS.
- 2) Use the EBL control on the ECDIS to bisect the target echo.
- 3) Read the target bearing.
- 4) Measure bearing of the target on the chart to calculate the difference between the actual bearing and apparent bearing on the radar screen.
- 5) Enter the difference found in step 4) in the [Heading Align] box.
- 7) [Video Level Adjust]: When the signal cable is very long, the video amplifier input level decreases, shrinking target echoes. To prevent this, confirm (and adjust if necessary) video amplifier input level.
- 8) Click the [Save] button to save the settings.
- 9) Click the [Close] button to close the [RCB Detail Settings] dialog box.

16.4 Error Between Radar Echo Image and Chart

There are several reasons why the radar echo image and chart display do not match exactly. The mismatch is a combination of several reasons and removing one reason doesn't solve the mismatch perfectly. There is a fundamental difference between the radar echo image and corresponding chart feature. The radar echo is a reflection from the real life target and the actual position of the real life target is the front edge of the radar echo. Therefore, the radar echo should start from the chart feature and exists as far as the radar pulse length goes.

Causes of bearing error

Bearing error occurs in the following instances:

- Gyro error
- Inaccurate chart
- Improper installation parameters (radar overlay bearing offset)

Causes of position error

Position error is caused by the following:

- Inaccurate position
- Position offset
- Inaccurate chart
- Improper installation parameters (conning position offset, position receiver antenna offset, radar overlay range offset)

16.5 Error Sources for Radar Echo Image and TT Mismatch

There are several reasons why the radar echo image and tracked target symbols do not match exactly.

- Different gyro value at radar overlay and at ECDIS.
- Improper installation parameters (radar overlay bearing offset, radar overlay range offset, conning position offset).

The example below shows how different gyro value set at radar overlay and at ECDIS affect the display of the ECDIS.

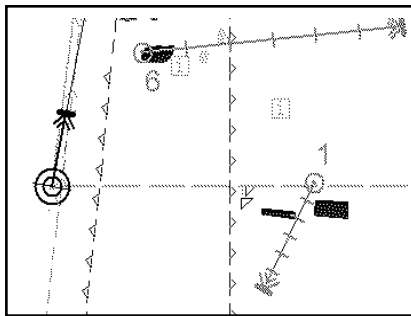

Different gyro value at radar and ECDIS

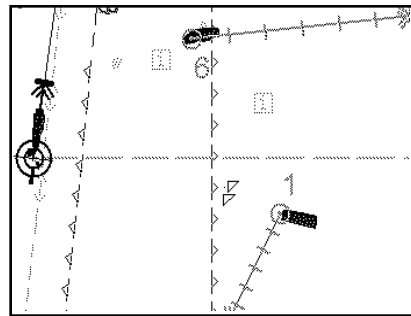

Equal gyro value at radar and ECDIS

17. WEATHER OVERLAY

17.1 What is the Weather Overlay?

The weather overlay, available in the Voyage navigation and Voyage planning modes, provides an animated display of weather information over time for the area selected. The information may include wave, ocean current, wind, temperature, cloud coverage, and precipitation rate. Spot weather information, which provides cursor-picked weather reports, is also provided.

The weather overlay is driven by GRIB (Gridded Information in Binary) data files. (This equipment supports GRB1 (1st edition) files.) GRIB is the format used by the world's meteorological institutes to transport and process global weather data. (GRIB2 files are output direct from Numerical Weather Prediction programs, which is usually the US GFS (General Forecast System.) Other models are used, however no one model is more reliable or accurate than another.

GRIB files are sent without review, thus there is no assurance that the data are accurate or correct. They are intended as an aid to weather forecasting - use them in conjunction with other weather data such as GMDSS forecasts and Navtex broadcasts.

GRIB forecasts are useful for short term planning. The US GFS mathematical model, for example, is run four times a day, and produces forecasts for up to 16 days in advance, but with decreasing reliability over time. The model calculates on a 3-D grid with horizontal spacing of approx. 27 km on a 1/2 degree grid - namely approx. 30 mile spacing.

Global forecasts (GRIB files) are available through a wide variety of sources; for example, e-mail, FTP, and web browser, and most are free to the user.

17.2 How to Activate, Deactivate the Weather Overlay

To activate the weather overlay, get into the Voyage navigation mode then click the Weather overlay button on the InstantAccess bar. The overlay is active when the background color of the button is light blue.

Note: The weather overlay and manual update mode (if active) are activated or deactivated reciprocally.



17. WEATHER OVERLAY

When the weather overlay is made active, two weather overlay dialog boxes appear, [Weather Overlay Control] and [Weather Overlay]. The [Weather Overlay Control] dialog box selects and plays back weather data files. The [Weather Overlay] dialog box controls what weather information to display and how to display it.

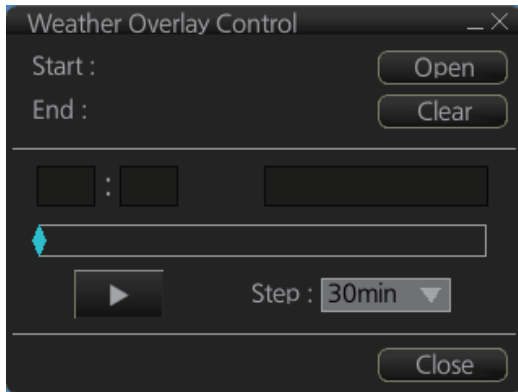

Weather Overlay Control dialog box

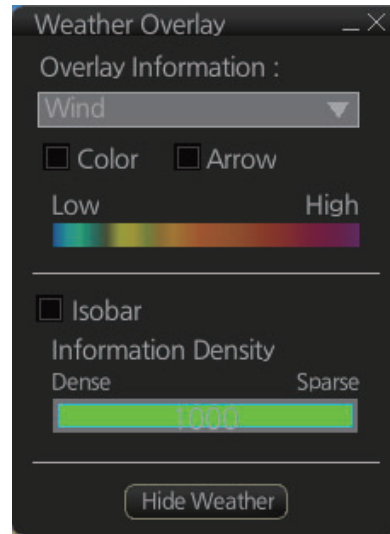

Weather Overlay dialog box

To deactivate the weather overlay, click the [Clear] button on the [Weather Overlay Control] dialog box to remove the weather overlay display then click the Weather overlay button on the InstantAccess bar.

17.3 How to Select, Playback a Weather Data File

1. Copy the weather data file (.grb extension) to a USB flash memory and insert the drive into a USB port on the PCU.
2. Activate the weather overlay then click the [Open] button on the [Weather Overlay Control] dialog box to show the [OPEN FILE] window. Click the [Volume select] drop-down list to select the USB flash memory.

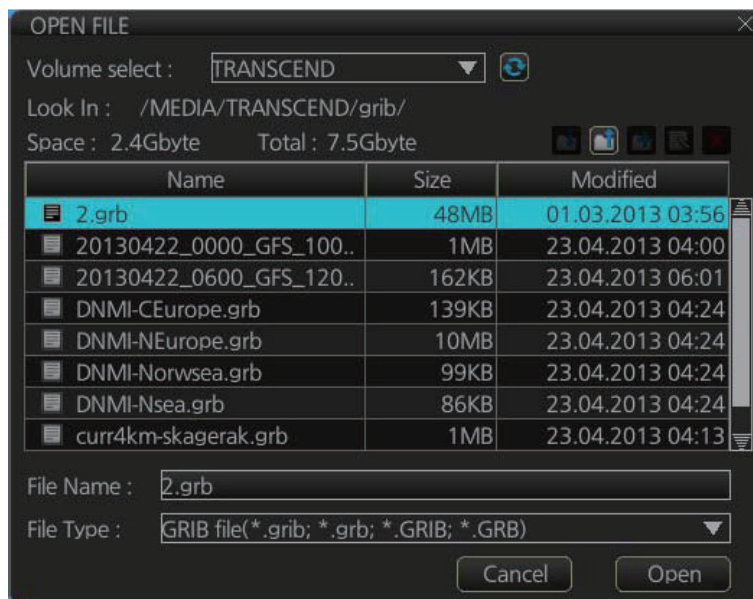

- Select the weather data file then click the [Open] button.
The message "Now Preparing..." appears while the file is being read, and "Now unmounting the media" appears when the reading is completed. The [Weather Overlay Control] dialog box shows the start and end times of the file. If the file is too large, the message "An error occurred. The file size is too large." appears. Select a smaller file - the maximum file size is 100 MB. If there is a problem with the file, the message "An error occurred while reading weather data file." appears. Select another file.

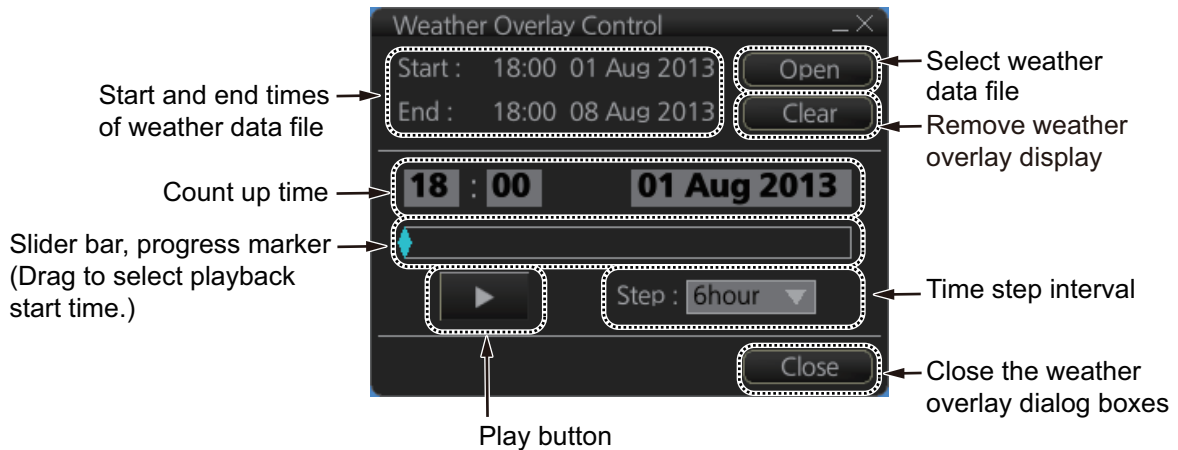

- To select a specific start time, drag the slider bar to show that time on the Count up time indication. (The time and date can also be entered manually. Use the software keyboard to enter the time. Click the date to show the [Set date] dialog box to select the date.)
- Use the [Step] drop-down list to select the time step interval, which defines how often to refresh (non-real time) the weather display. The choices are 30 minutes, 1 hour, 2 hours, 4 hours, and 6 hours.
- To play or pause the playback, click the Play (▶) button.
- To close both weather overlay dialog boxes, click the [Close] button. (The weather overlay remains active.) To redisplay them, click the Weather overlay button.

17.4 How to Set up the Weather Overlay

The weather overlay is set up from the [Weather Overlay] dialog box, in the Voyage planning mode or the Navigation planning mode (overlay must be active).

- Select a display from the [Overlay Information] drop-down list. The choices are [Wind], [Temperature], [Cloud Coverage], [Precipitation Rate], [Wave], and [Ocean Current]. (The weather data file must contain the data selected in order to display it.)

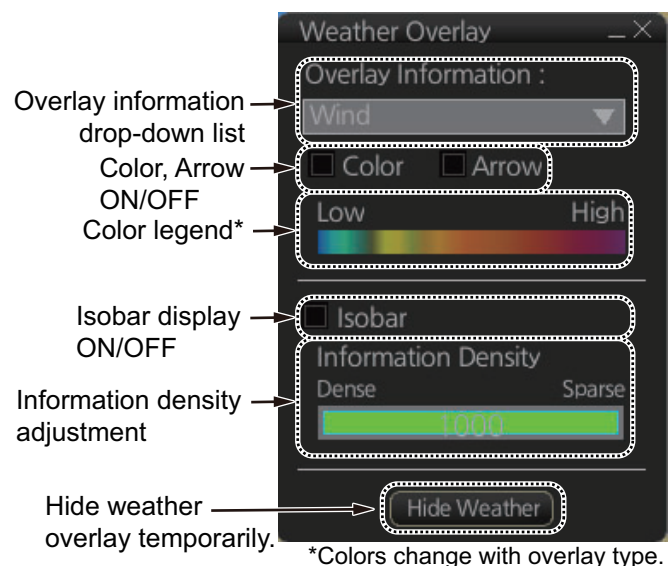

*Colors change with overlay type.

17. WEATHER OVERLAY

- The [Color] checkbox, when checked, provides a color presentation of the weather item selected. (Unchecking the checkbox erases the color presentation.)
- The [Wind], [Wave] and [Ocean Current] displays can show windbarbs (wind) or arrows (waves, ocean currents) to indicate the direction of respective item. Check [Arrow] to show the windbarbs or arrows.
- For any display, show or hide the isobar with [Isobar]. The isobar is the black curved line in the right figure and it connects points of equal atmospheric pressure. "H" appears in the case of high atmospheric pressure; "L" for low atmospheric pressure.
- Set the information density with the [Information Density] bar. Drag the bar to required setting. The figure below shows several information density settings and the resulting displays.

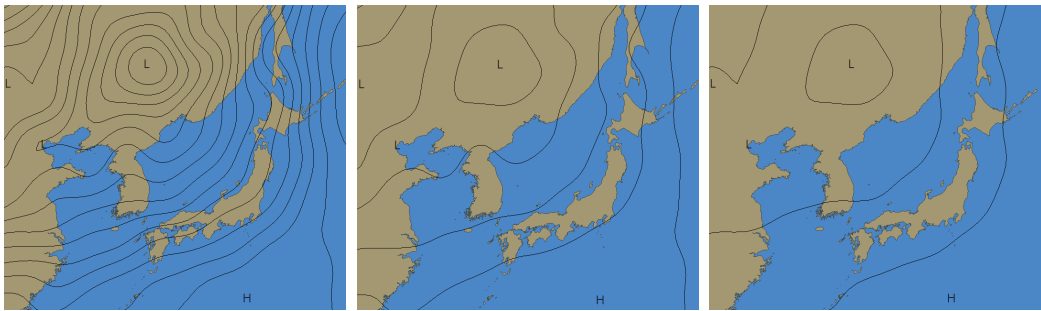
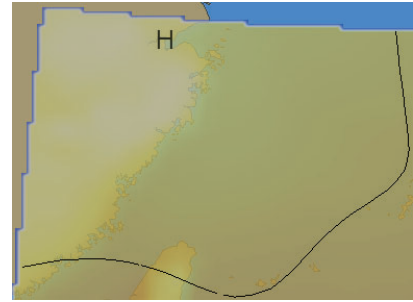

Full dense

Medium

Full sparse

- To hide the weather overlay temporarily, click and hold down the [Hide Weather] button. Release the button to redisplay the overlay.

17.5 Weather Overlay Examples

17.5.1 Wind display

The wind display provides wind speed and direction. Windbarbs show both wind speed and direction. The relative wind speed is shown in colors, from blue (low) to magenta (high).

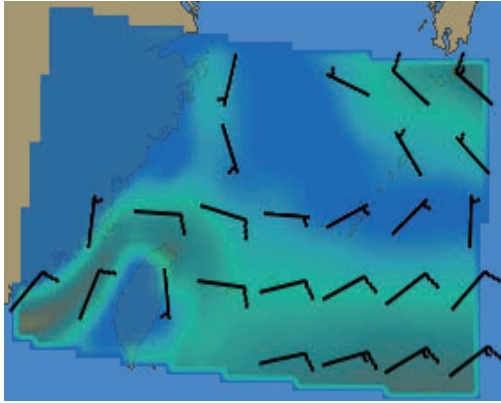

How to read the windbarbs

Windbarbs represent both wind speed and direction. The windbarbs point in the direction from which the wind is blowing. Lines and filled pennants on the windbarbs indicate speed.

- A half line represents speed from 1.49 to 4.08 kn
- A full line represents speed from 4.09 to 6.68 kn
- A filled pennant represents speed from 24.69 to 27.28 kn

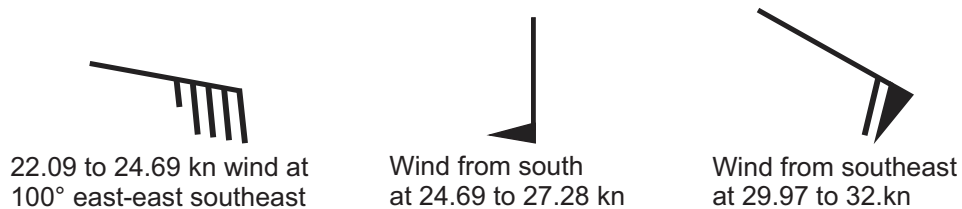

Example windbarbs

17.5.2 Temperature display

The temperature display provides air temperature information, in colors from blue (low) to red (high). The entire area in the figure below has moderately high temperatures.

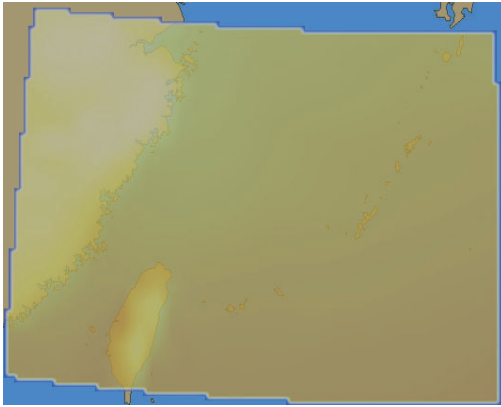

17.5.3 Cloud coverage display

The cloud coverage display shows areas obscured by clouds, in transparent (low) to light gray (high). In the figure below, clouds are covering the landmass and body of water at the top left corner.

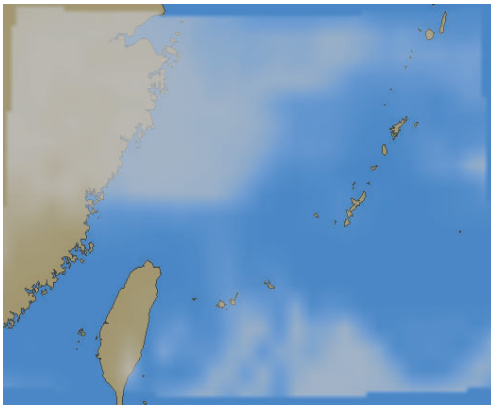

17.5.4 Precipitation rate display

The precipitation rate display shows accumulated precipitation over an hour, in colors from blue (low) to blue (high). In the figure below light-to-heavy rain is present at the top left corner.

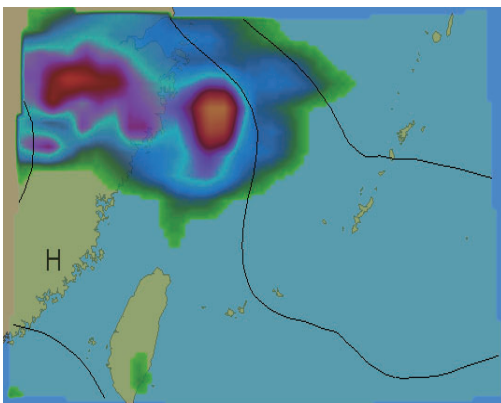



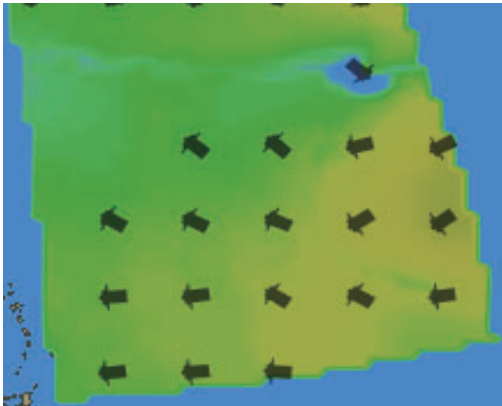

17.5.5 Waves display

The waves display shows the average height of the highest waves, in colors from transparent (low) to red (high). The length of an arrow indicates wave height. The arrow points in the direction of the main swell.



Arrow length and wave height (m)







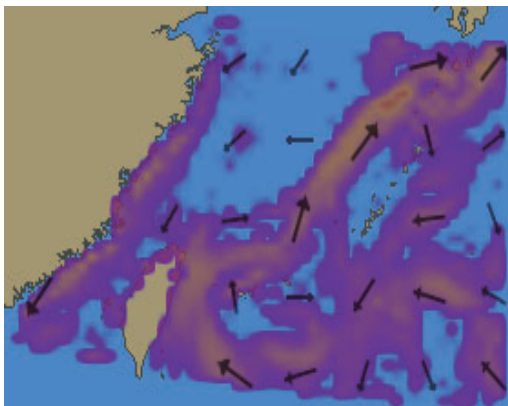



Less than 1	Less than 3	Less than 5
(No arrow)		
Less than 7	Less than 9	Higher than 9
		

17.5.6 Ocean current display

The ocean current display provides ocean current direction and speed information. The arrows show both direction and speed. Speed is also shown with colors, from transparent (low) to red (high). The color of the currents in the figure below indicate that their speed is low.



Arrow length and current speed (kn)

Less than 0.06	Less than 0.25	Less than 0.97	Less than 1.45
(No arrow)			
Less than 1.94	Less than 2.43	Less than 2.91	Less than 3.4
			
Less than 3.88	Less than 4.37	More than 4.37	
			

17.6 Weather Spot Information

You can get various weather information for any area with the weather spot information feature, in the Voyage navigation and Voyage planning modes. The weather overlay must be active and position data available.

1. Right-click the location for which you want to know its weather to show the context-sensitive menu.
2. Click [Weather INFO] to show the [Weather Spot Information] window. The window shows [N/A] where there is no data for the corresponding weather item.

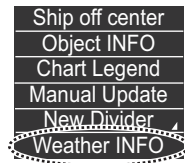

Weather Spot Information	Item	Description
Time : 14:00	Time	Time and date of weather forecast.
POSN : 06 Dec 2013	POSN	L/L position of weather forecast.
26° 09.704' N	Wind	Wind speed (kn) and direction (degree).
126° 15.132' E	Temperature	Temperature, in °C.
Wind : 7.4kn 19.4°	Cloud Coverage	The fraction of the sky obscured by clouds, expressed in percentage.
Temperature : 20.8° C	Precipitation Rate	The amount of precipitation (rain, snow, etc.) in millimeters to fall in one hour.
Cloud Coverage : 8.9%	Wave	Wave height (in meters) and wave direction (in degrees).
Precipitation Rate : 0.0mm/h	Ocean Current	Current velocity (kn) and direction (degree).
Wave : 2.3m 20.3°	Pressure	Atmospheric pressure, expressed in hPa.
Ocean Current : 0.1kn 327.8°		
Pressure : 1018.7hPa		

3. To erase the window, click the Close button at the top right corner of the window.

17.7 Summary of Weather Overlay Viewability, Operability and Operating Mode

The table below summarizes the operability and viewability of the weather overlay according to the operating mode.

Item	Operating mode	
	NAVI	PLAN
Activate weather overlay	Yes	No
View weather overlay	Yes	Yes
Select weather data file	Yes	Yes*
Operate weather overlay related dialog boxes	Yes	Yes
Deactivate weather overlay	Yes	Yes
Restore weather display when switching from chart mode or playback mode	Yes*	Yes*
Weather spot information window	Yes	Yes

*Weather display previously active

18. NAVIGATION SENSORS

18.1 CCRS

This ECDIS employs a Consistent Common Reference System (CCRS) for the acquisition, processing, storage and distribution of sensor information. The CCRS ensures that all parts of the system uses the same source and values, e.g., speed through water, heading, etc. The illustration below shows the CCRS diagram.

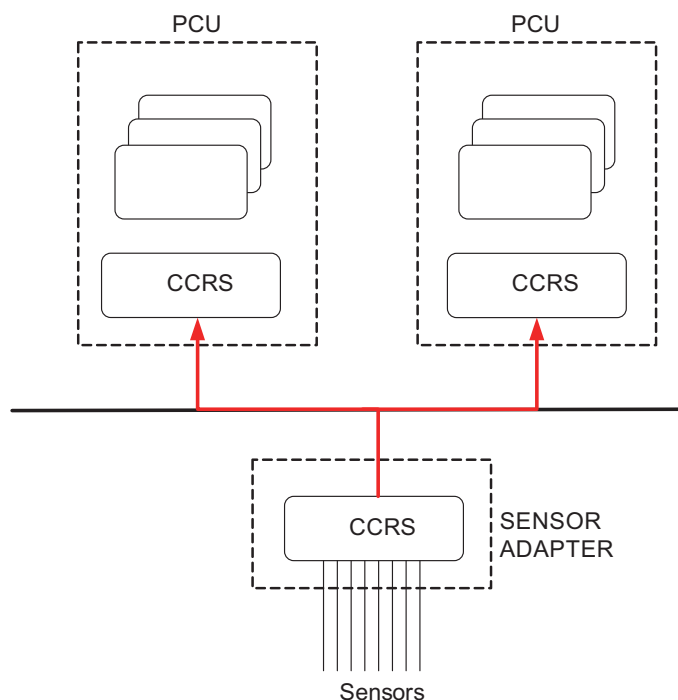

The CCRS process NMEA0183 and IEC 61162-1 sentences. No other types of data (video signals, etc.) are processed.

Check for validity, legitimacy

The system checks received sentences for validity and legitimacy.

Validity check: A sentence's checksum, status (A/V), Mode indicator and setting values are checked. (If checksum error is found, the sentence is dis-affirmed.)

Legitimacy check: The range and accuracy of a sentence is checked.

If the check for both is OK a valid flag results. If either is invalid, the invalid flag is given.

Types of CCRS

There are two types of CCRS: System and Local. The System CCRS integrates all navigation devices. In the Local CCRS each navigation device operates independently.

Representative sensors

If the system has multiple like sensors, the CCRS selects the representative sensor. Generally, the system uses common representative sensors; however, independent representative sensors (local representative sensors) can also be used.

18.2 How to Select Navigation Sensors

The operator can choose navigation sensors to use for navigation and view their current values on the applicable page in the [System Sensor Settings] and [Local Sensor Settings] menus. To access these menus, right-click the [Sensor information] box then click [Open MENU].

18.2.1 Sensors menu description

HDG page



Local sensor HDG page

Sensors: Select the heading sensor to use.

Analog Gyro: No use.

Manual: Set heading manually when there is no heading sensor available.

Gyro Correction: Check to enable gyro correction. Enter correction value in box. Not shown in system sensor [HDG] page. Valid for sensor activated on database.

SPD page

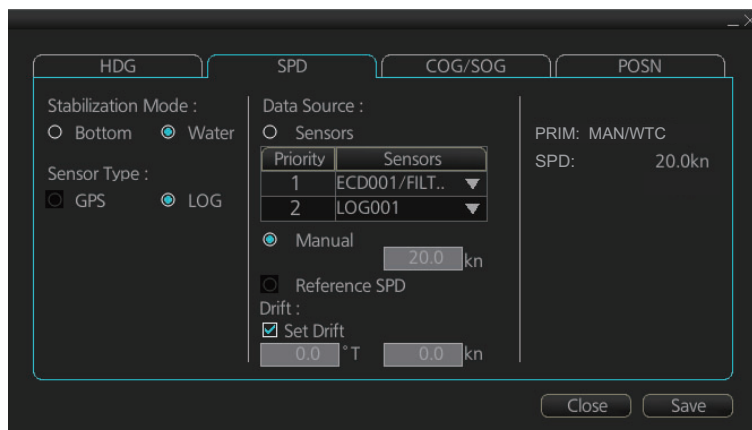

Local sensor SPD page

Stabilization Mode: Select the water stabilization mode: Select [Bottom] for ground stabilization, or select [Water] for sea stabilization.

Sensor Type: Select [GPS] in case of a GPS navigator, or [LOG] for speed log.

Data Source: Check [Sensors] to use a sensor in the [Sensors] list, or click [Manual] to enter speed manually. Use [Manual] when no speed source is available.

Reference SPD: If checked, radar is used as the source for speed and course. Checkmark is valid when the speed measurement method is “ground”. Not available with system sensor.

Set and drift: Check the [Set Drift] checkbox to manually set speed and course of drift. Note that you can select manual drift only if you deactivate the AIS function. Checkmark is valid when the speed measurement method is “water”. Not available with system sensor.

Angle = Difference between heading and COG

Spd = Speed component of the drift vector

Cse = Course component of the drift vector

Vector defined by (SOG and COG) is equal to vector sum of vectors defined by (SPD and HDG) and (set and drift).

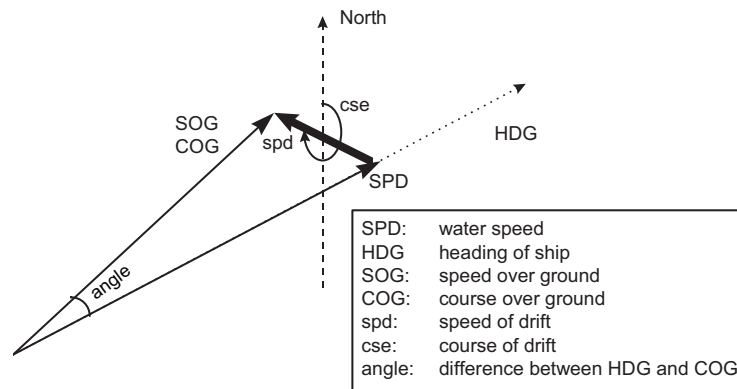

COG/SOG page

Select the source (GPS receiver) for speed over the ground and course over the ground.

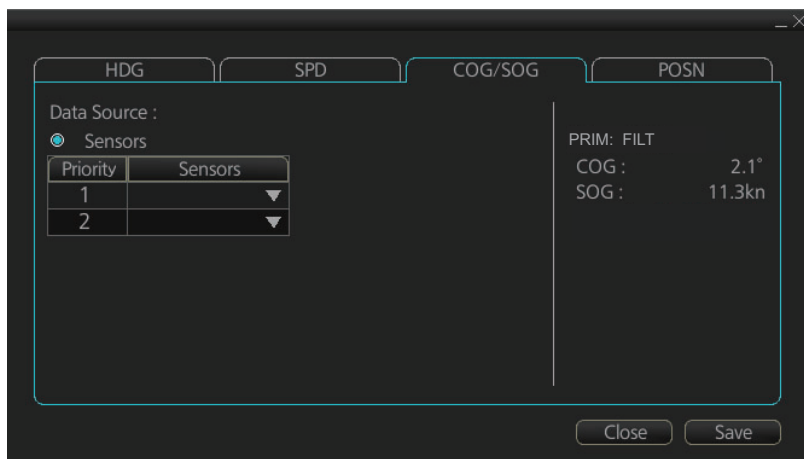

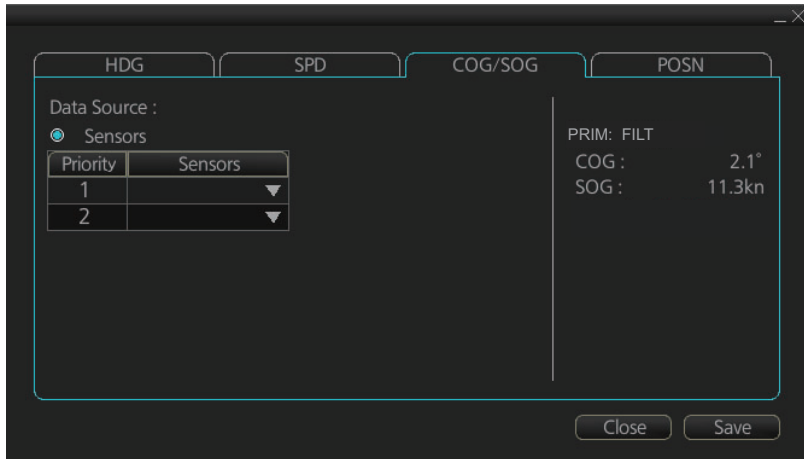
POSN (Position) page

Sensor: Name of sensor used. Position sensors have priority in order of accuracy. When a sensor is changed, the Alert 30602 "Position Source Change" appears.

Manual: When a sensor cannot be used, select [Manual], then enter position manually.

Other sensors page

To show the [Other Sensors] page, open the menu and select [Other Sensor Settings].

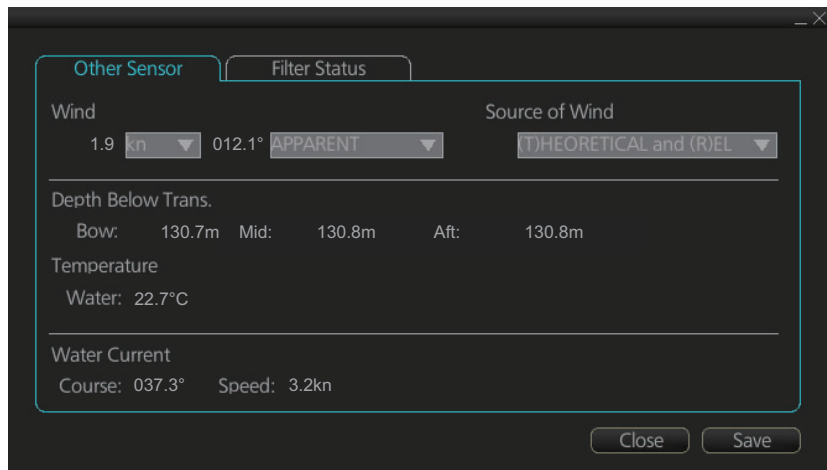

Wind: Select wind unit, wind reference, and wind source. See section 18.9.

Depth Below Trans: Depth from hull at bow and aft to bottom. A depth alert value may be entered to alert you when the depth is within the value set.

Temperature: Water surface temperature.

Water Current: Tide at own ship's position.

18.3 Source of Position

The figure below shows how source for position is chosen. The position sensors have either primary or secondary as input for their calculation. DGPS position sensors are considered more accurate than other position sensors.

The latitude and longitude position is shown at the top-right position on the chart display, and in the example below the position source is DGPS. Other indications that may be displayed in the position area are as follows:

- **DR:** Shown in yellow when position source is dead reckoning.
- **DGPS, GPS:** Name of position source.

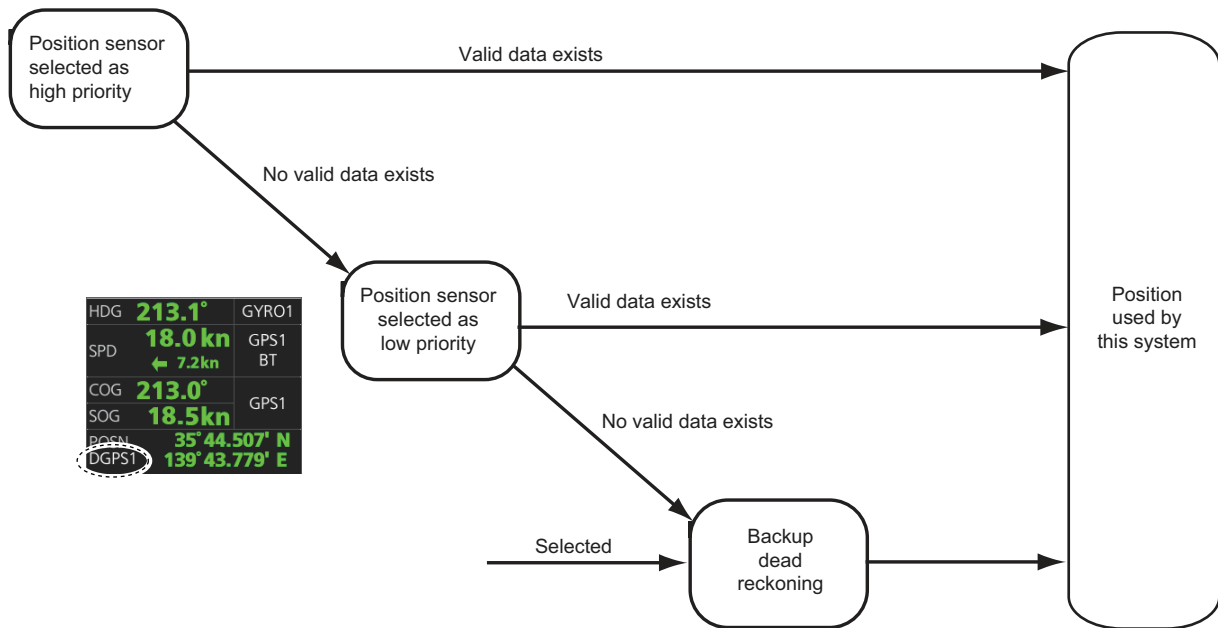

If the system changes the source of position because of lost sensor data, the system immediately generates the Alert 472 "Position Source Change".

18.4 CCRP, Primary and Secondary Positions of Own Ship

This system displays position in one of four methods

- **CCRP position:** CCRP
- **Primary position:** Position generated by position source chosen as highest priority.
- **Secondary position:** Position generated by position source chosen as 2nd highest priority.
- **Pivot position:** Ship's pivot point position.

The position source for primary position of own ship is chosen as Primary on the [POSN] page of the [Sensor] menu.

The position source for secondary position of own ship is chosen as Secondary on the [POSN] page of the [Sensor] menu. Secondary position of own ship is not available as latitude/longitude value for the user.

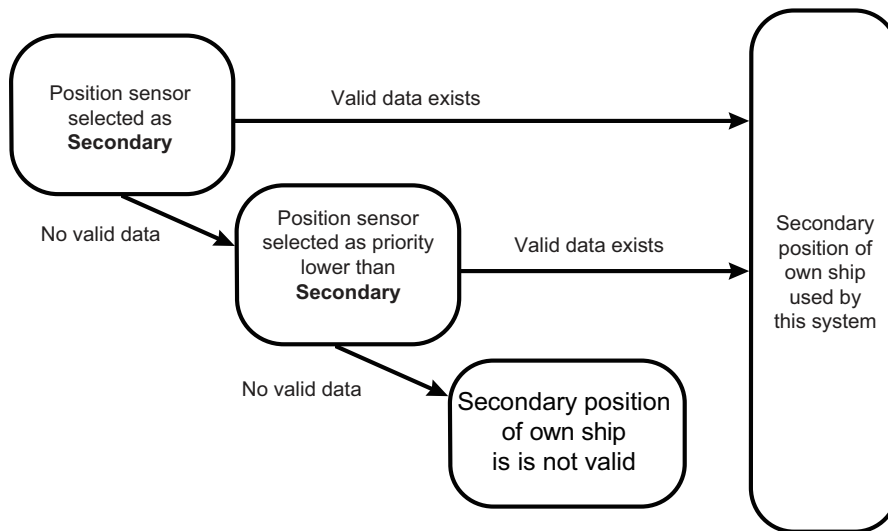

Past ship's track can be plotted on the chart with reference to CCRP, Primary, Secondary or Pivot position. You can control their visibility of the tracks, etc. from the [Tracking] page of the [Symbol Display] menu, shown in the right figure. In this example, past tracks are plotted using the primary position-fixing equipment.

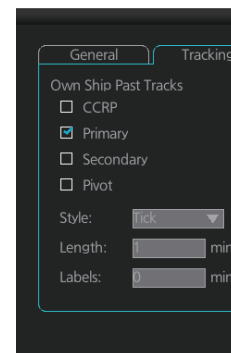

18.5 Source of Navigation Data

The figure below shows how various sources of navigation data are chosen. "SOG, COG" is speed over the ground and course over the ground, respectively. "SPD" is speed through the water. "Drift" is the difference between speed through the water and speed over ground.

Heading used by the system is shown at the top-right position on the chart display. In the example shown below, heading is received from a gyrocompass and it is shown without additional text, meaning the value is referenced to true North. Additional gyro-related text that may appear is "(GYRO-A)" if the value is referenced to magnetic North.

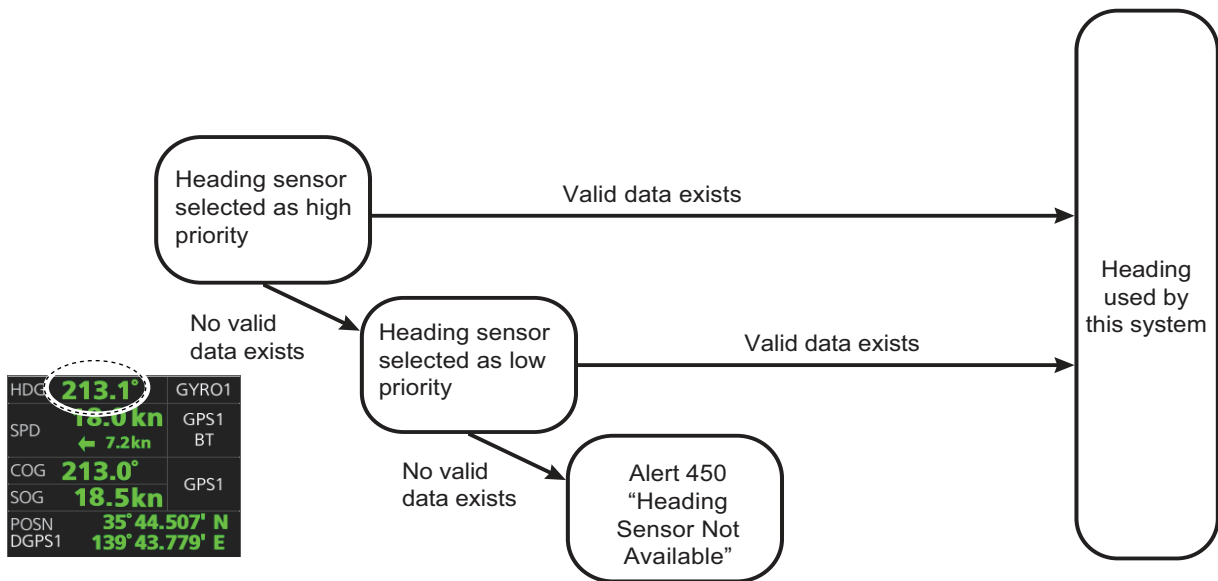

SOG/COG used by the system is shown at the top-right position on the chart display. In the example below, COG and SOG are from chosen position sensors and this is indicated with the text "GPS*" or "LOG*" (* is the number of sensors).

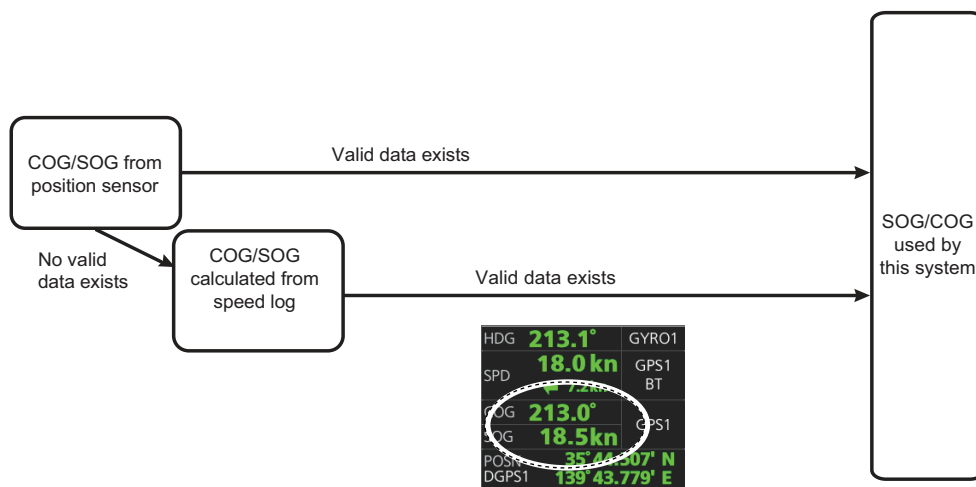

18. NAVIGATION SENSORS

Speed used by the system is shown at the top-right position on the chart display. The figure below shows the source of water speed is used for drift calculation.

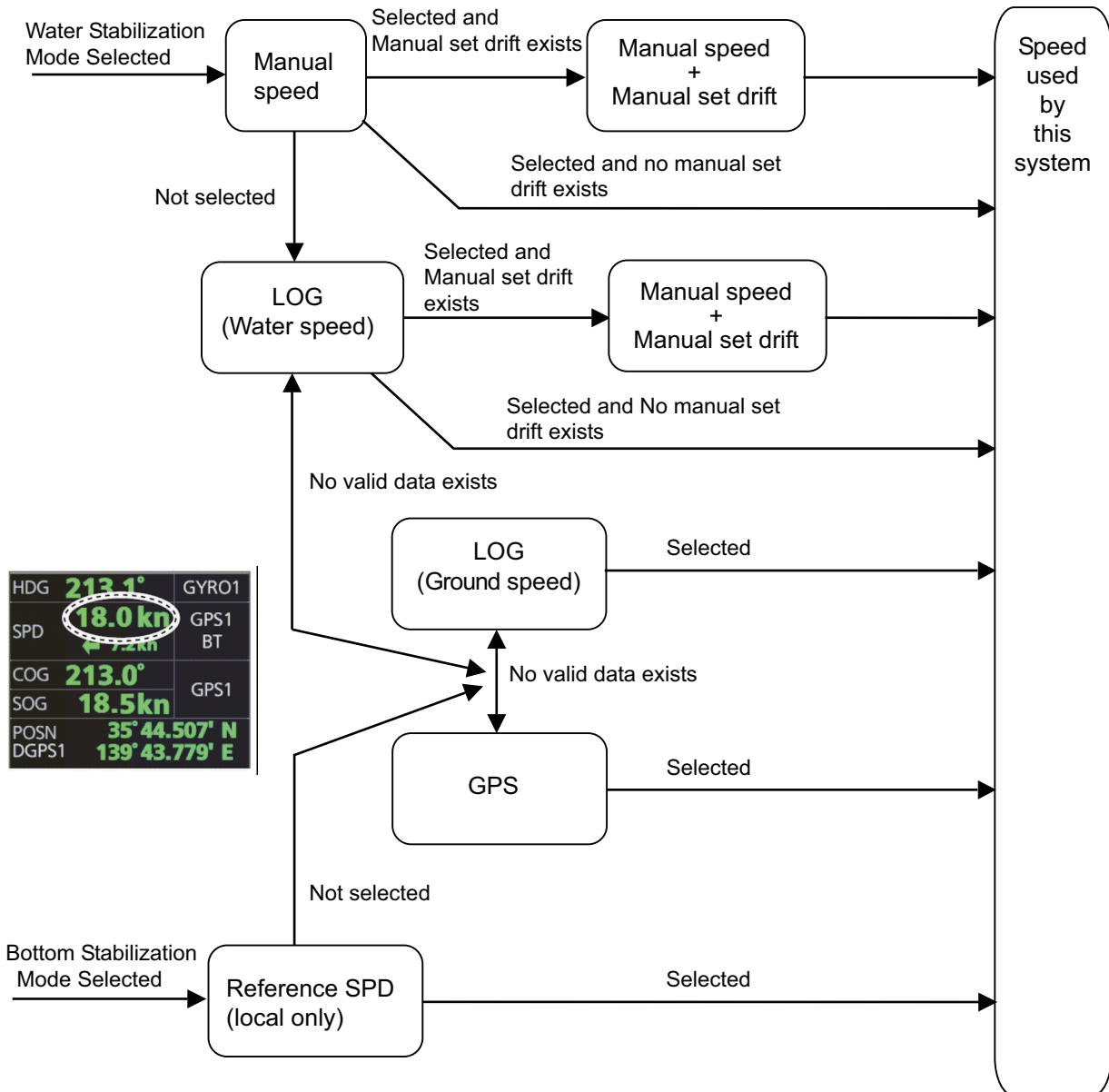

Alert related to SOG, COG, speed and heading components

It is possible that the operator has not chosen any speed or heading sensors, or that the chosen sensors do not have any valid values. This kind of a situation is critical for the system, because it cannot even perform dead reckoning.

When no heading source is available, the system generates the Alert 450 "Heading Sensor Not Available."

When no speed source is available, the system generates the Alert 453 "SDME Sensor Not Available."

When no COG/SOG data is available, the system generates the Alert 279 "COG/SOG Not Available."

18.6 Switching of Sensor and Indication

When a sensor cannot be used because of some problem, the system automatically switches the sensor. When this occurs the name of the newly selected sensor appears in yellow.

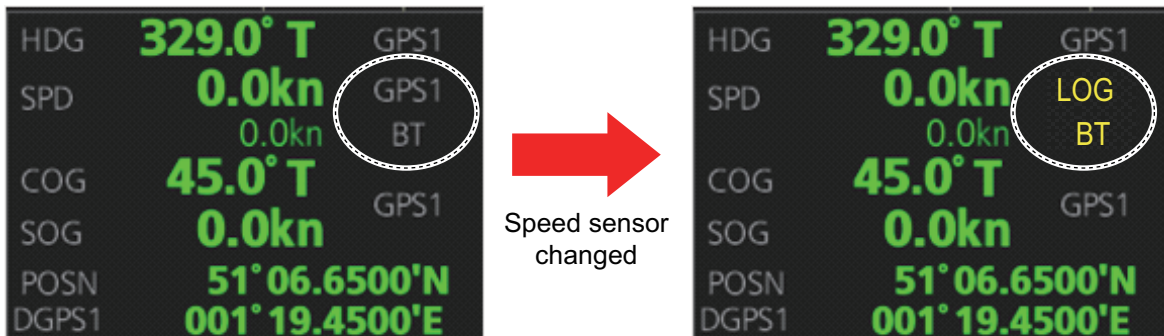

18.7 Filter Status

The ECDIS incorporates a filter that receives raw sensor data, checks sensor integrity and processes multiple sensor data to produce a continuous estimate of ship's position and motion.

By default, the filtering uses data from all available sensors for filtering and integrity monitoring. The exception is heading data; only the selected heading device affects the filter output, but other heading sensors (including magnetic compasses) are used for integrity monitoring.

Sensors may be excluded manually or automatically. An excluded sensor participates in neither integrity monitoring or filtering. The filter automatically excludes a sensor from use if the sensor fails the first level of integrity check (for example, if a sudden jump is detected). If the actual integrity check fails for some reason and the filter is able to identify the faulty sensor, the faulty sensor is automatically excluded.

Sensor integrity is determined by:

(1) monitoring the statistical accuracy of each sensor independently and analyzing the input values and using the information of the type of sensor.

(2) monitoring the difference between pairs of sensors.

The system checks heading, rate of turn, position, COG/SOG and CTW/STW data for integrity, in accordance with INS regulations (IEC-61924-2). The result is either [Doubtful], [Excluded], [Failed], [Not Available] or [Passed]. The integrity check result appears in the following locations:

- [Filter Status] page in [Other Sensor Setting] menu.
- [Local Sensor Setting] and [System Sensor Setting] menus.

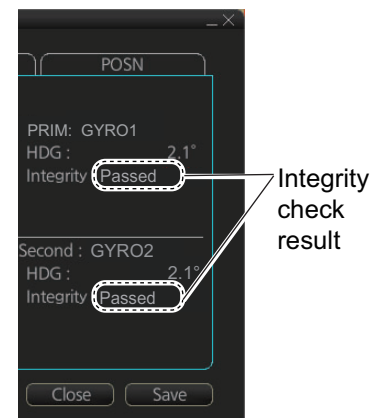

Note: The integrity results appear in the [Local Sensor Setting] and [System Sensor Setting] menus only if the menu item [Color of own ship's information(TEXT) will be changed by result of integrity check] is checked during installation.

Passed: Data is available for comparison and data is normal.

Low Accuracy: Data signal strength is low, but data is normal.

Doubtful: Data is not available for comparison, but data is normal.

Failed: Data may or may not be available for comparison, and data is abnormal

Excluded: Data value changed significantly

Not Available: Sensor malfunction or data is improper.

Note: For heading data, if there is only one gyro connected, the judgment is "Doubtful" when the speed is 10 kn or less because heading cannot be checked against COG. If the speed is higher than 10 kn, COG can be checked against heading so the judgment is "Passed".

The methods of integrity monitoring are outlined in the table below.

Sensor	Comparison
Position	<ul style="list-style-type: none"> • Comparison with other position sensors. • Comparison with dead reckoning position.
Heading	<ul style="list-style-type: none"> • Comparison with other heading sensors. • Comparison with a COG sensor (used only if other heading sensors are not available and if COG is high enough).
Speed over the ground	<ul style="list-style-type: none"> • Comparison with other SOG sensors. • Comparison with water speed sensors is a secondary option (used only if other SOG sensors are not available).
Speed through the water	<ul style="list-style-type: none"> • Comparison with other STW sensors. • Comparison with SOG sensors is a secondary option (used only if other STW sensors are not available).
Rate of turn	<ul style="list-style-type: none"> • Comparison with other rate of turn sensors.

The status and integrity of all sensors can be monitored from the [Filter Status] page in the [Other Sensor Settings] menu. Sensors can also be unselected and the filter re-set from this page.

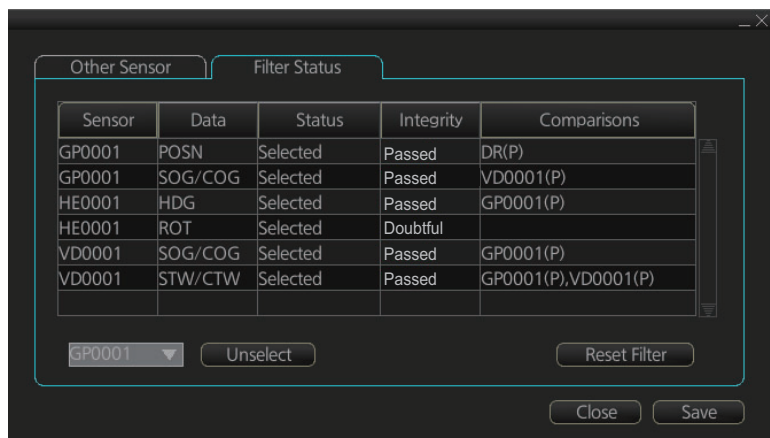

The [Status] column indicates sensor status as follows:

- [Selected] (sensor selected for use in filter)
- [Unselected] (sensor not used in filter)

- [Not Available] (no sensor information)
- [Excluded] (automatically excluded sensor)

The [Integrity] column indicates sensor integrity as either [Passed] or [Failed]. The integrity evaluation is [Doubtful] when there are no other sensors to compare with.

The [Comparisons] column shows the sensors compared and the integrity evaluation of compared sensors in parentheses. Using the illustration above as an example, SOG/COG data fed from GP0002 is compared with the sensors GP0001 and VD0001. The integrity evaluation for the compared sensors is [Passed].

To deselect a sensor manually, select the sensor from the drop-down list at the bottom left corner of the page, click the [Unselect] button then click the [Save] button. [Unselected] appears in the [Status] column. To reselect an unselected sensor, select the sensor from the drop-down list, click the [Select] button. [Selected] appears in the [Status] column.

The [Reset Filter] button functions to recover from sensor failure. When the button is operated:

- Automatically excluded sensors are re-included.
- All data history is erased.
- Output values are re-estimated using new data.
- Integrity monitoring is restarted using new data.

Note 1: The filter can also be reset from the context-sensitive menu. Right-click anywhere in the [Own ship information] box, then select [Filter Reset].

Note 2: The filter reset feature resets all units connected in the network.

18.8 Position Alignment

The position alignment feature functions to fine tune ship's position by using radar, radar echo target and ECDIS chart material.

If position alignment is in use, the Alert 30803 "Chart Align: Over 30 Min." is generated every 30 minutes to remind the user to align position. The alert is automatically erased in 10 seconds.

Note: This feature is effective with the ECDIS unit whose data source for FILT is assigned the highest priority.

18.8.1 How to align position

If the radar echo targets' symbols are not positioned correctly on the chart, there is either position error or gyro error or some combination of these errors.

Position may be aligned on the ECDIS display by moving own ship position or by moving radar target position. To align position, get into the Voyage navigation mode, then click the [Offset] button at the

top-right position on the screen. (You are asked if you want to align position; click the [Yes] button to proceed.) Put the cursor on the correct position then click. The amount of offset, in bearing and range, appears to the right the [Offset] button. The maximum offset in distance is 10.0 NM.



18. NAVIGATION SENSORS

The latitude and longitude position indication is shown in yellow characters when the position align feature is active.

18.8.2 How to cancel position alignment

Click the [Offset] button to cancel the position offset.

18.9 Wind Sensor

ECDIS can display and output wind data in the following three formats:

Apparent: Windmeter-measured wind speed and direction.

Wind angle reference: Heading

North: True wind angle, true wind speed, referenced to North

Wind angle reference: True North

Theoretical: True wind angle, true wind speed, referenced to heading

Wind angle reference: Heading

The illustration below shows wind speed and direction with given ship data.

The wind values are as shown below.

Ship information:

COG: 60°

SOG: 8.7 kn

Heading: 45°

	Wind angle	Wind speed
Apparent	345°	10 kn
North (true wind, referenced to North)	330°	5 kn
Theoretical (true wind, referenced to heading)	285°	5 kn

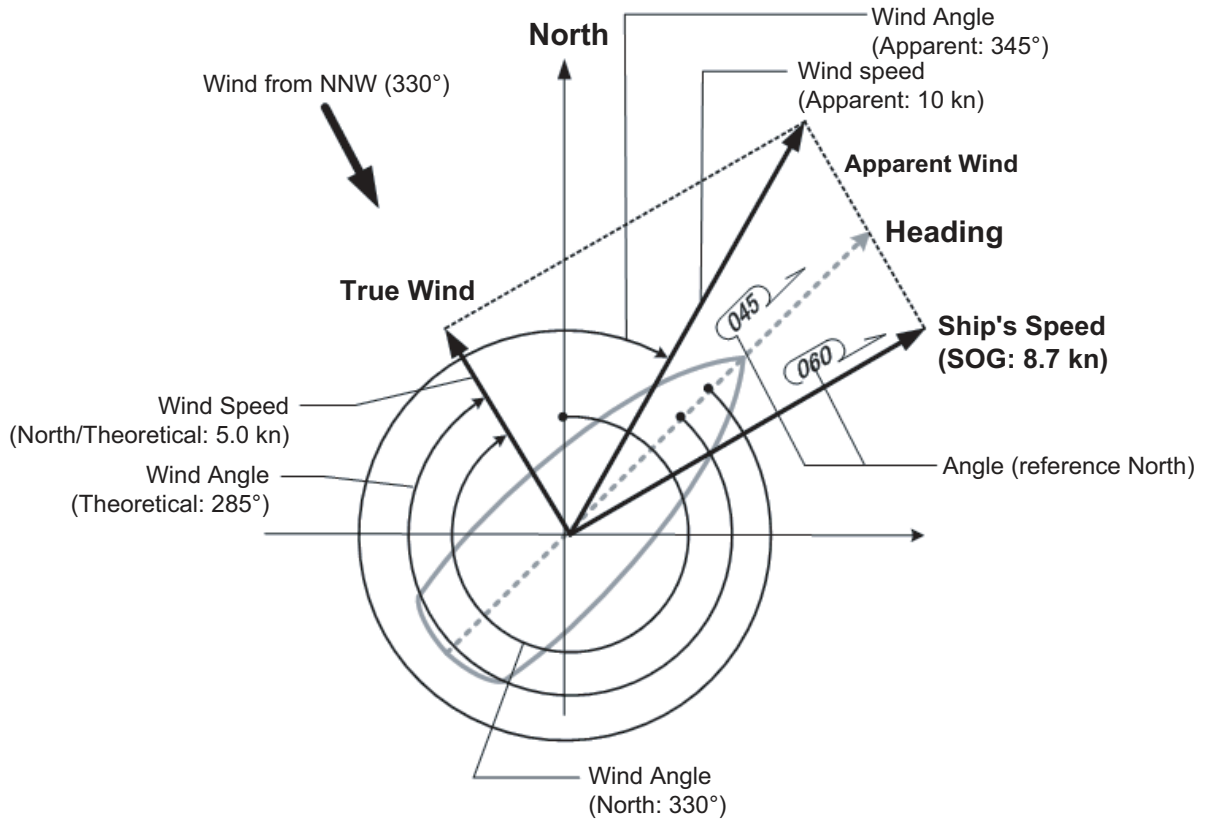

Apparent, North (true wind referenced to North), Theoretical (true wind referenced to heading) may be selected from the [Other Sensor Settings] menu. If the wind indication is not accurate; for example, the wind is blowing from the North but the wind direction displays otherwise, check if the format is Theoretical. If it is, switch to another format.

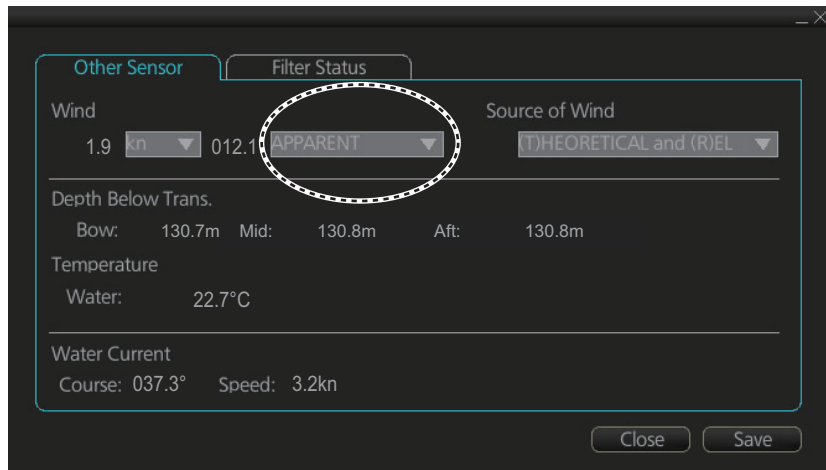

18.10 Depth Sensor

The depth output from a depth sensor (for example, echo sounder) is shown on the [Other Sensor] page in the [Other Sensor Settings] menu.

The content of the [Other Sensor] page depends on sensors connected.

In this example there are three transducers (bow, mid and aft) installed.

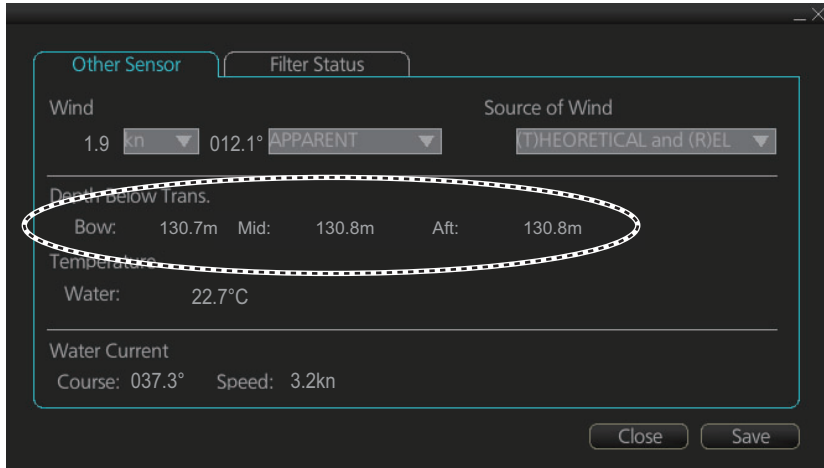

The system displays depth value as depth below the transducer. If required, you can get an alert when the measured depth is less than the "Echo Alarm Limit" setting at the [UKC] page in the [Overlay/NAV Tools] box. The system generates the Alert 30801 "Depth Limit".

19. RECORDING FUNCTIONS, PLAY-BACK FUNCTIONS

The ECDIS records various items during a voyage, like movement and position of your ship and dangerous radar targets (from the radar). These items are recorded in the following logs:

Update log:	Records the install and update history for the ENC, ARCS and C-MAP charts (see section 7.3).
Event log:	Records user events and position events.
NAV log:	Records entire voyage (i.e., a sailing of a route from first point to the last, also MOB data), details (position, speed and course every minute), chart usage (information on charts used for display).
Target log:	Records dangerous TT, AIS.
Alert log:	Records alerts generated by the system (see section 20.7).
Route transfer log:	Records sent and received route-related communications.

19.1 How to Record User, Position Events

This equipment can save/show a maximum of 2,000 events.

19.1.1 User events

A user event is a comment about an event (weather, etc.). You can show user events on the chart area. Open the [Tracking] page of the [Symbol Display] menu show or hide the events.

To record a user event:

1. Click the [Record], [Event Log] and [User Event] buttons on the InstantAccess bar to show the [Record User Event] window.
2. Enter a comment. Click the [OK] button to finish and close the text box.



An event marker (☑) (orange) appears at your position and the event is recorded to the [Voyage] log.

To view an event comment, get into an ECDIS mode other than Chart maintenance, put the cursor on the event then left click to show the [Event Information] window. The window shows the name of the event ([UserEvent]), time and date of entry, latitude and longitude position of the event and comment. Note that the comment can be edited from this window. Edit the comment then click the [OK] button to save.

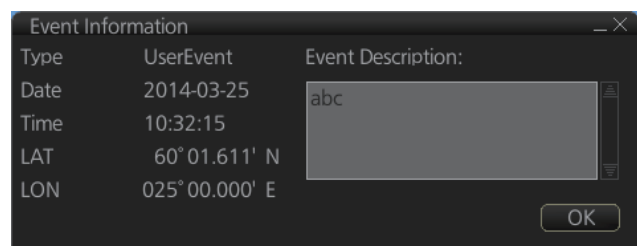

19.1.2 Position events

The purpose of a position event is to record current position data to the [Voyage] log. Position events can be shown in the chart area by checking [Positions] on the [Tracking] page of the [Symbol Display] menu. Do as shown below to record position events.

To record a position, do the following.

1. Get into the Voyage planning mode.
2. Click the [Record], [Event Log] and [POSN Event] buttons on the InstantAccess bar to show the [Position Event] dialog box.

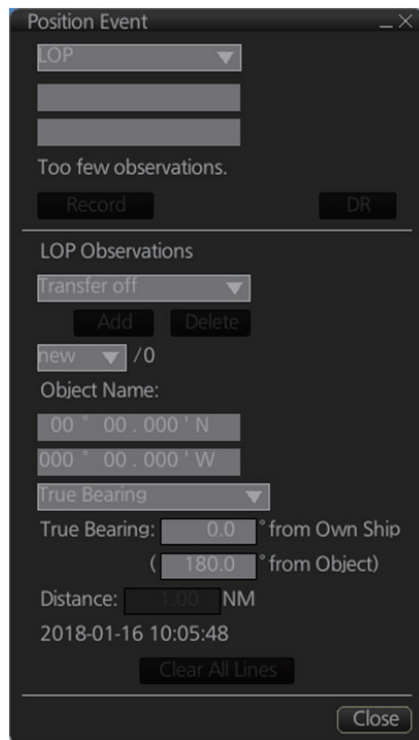

3. At the list box at the top of the dialog box, select position type.
[LOP]: Latitude and longitude position of a fixed object at ship's position.
[Position]: Ship's position fed from navigator selected.
[Manual]: Manual entry of position.
4. If you selected position at step 3, click the [Record] button.



The [Position Event] window shows the position at the moment the [Record] button is clicked. The position is recorded to the [Voyage] log.

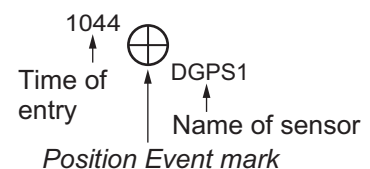

5. If you selected [Manual] at step 3, enter latitude and longitude position and comment (optional), then click the [Record] button.

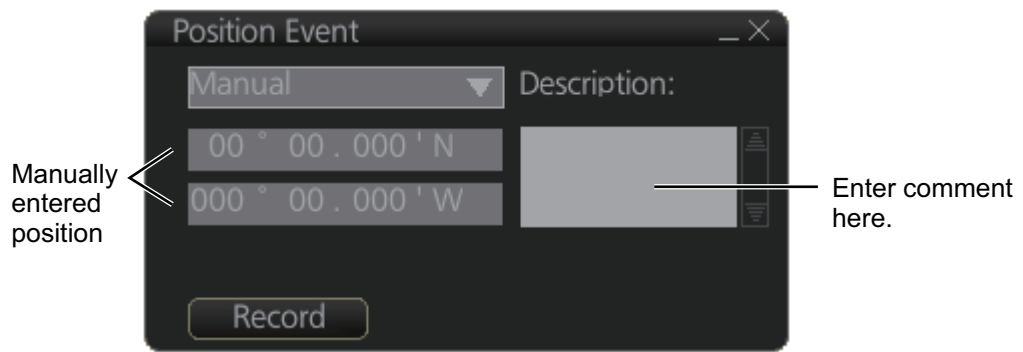

The [Position Event] window shows the position at the moment the [Record] button is clicked. The position is recorded to the [Voyage] log.

6. For [LOP], see the description below.

A plotted line on which a vessel is located, determined by observation or measurement of the range or bearing to an aid to navigation or other charted element. Two or more simultaneous observations can be combined to produce an estimate of the ship's current position. If the position is based on only two observations, it is an "estimated position" (EP); otherwise it is called a fix. A maximum of 6 observations can be entered to obtain a fix.

Basic operation: Coordinates of the aid to navigation can be entered into dialog boxes or they can be selected graphically on the chart:

- S57: Click on a charted object (beacon, light, buoy etc.) or any location. Description of the object appears above coordinate boxes.
- ARCS: Click anywhere in the chart.

Default values for bearing and range are approximated from ship's current position information. The time of observation is stopped when the object is selected (or when the [Add] button is clicked). Click the [Add] box to include the observation in the fix computation. The counter shows "new/1", at the input of the second observation. The word "new" indicates that the observation currently displayed is not yet included in the fix computation, and it appears as a dashed line or ring on the chart. The added observations can be edited or deleted after selecting them at the counter. When at least two measurements are entered, the EP or fix is computed and the coordinates are shown in the top part of the dialog. To show a position symbol on the chart, click the [Record] button. In the case of an EP, the letters EP are shown on the right side of the coordinates. If a valid position estimate cannot be obtained, a message is displayed under the coordinates. This may happen, for example, if the lines / circles have multiple crossings that are far apart, or if two lines are nearly parallel or don't intersect at all. The accuracy limit (estimated standard error) is 1.0 NM. If the estimate is valid, the [Record] box can be clicked to record the current position estimate in the [Voyage] log. Discrepancy between LOP result and ship position is also recorded in the log (this information may be viewed by Info query on the position event symbol on the chart - which is displayed if position event display is on in chart display settings).

Time transfer: If the observations are not simultaneous, they should be transferred to a common time. Transferring is based on dead reckoning of ship movement. If a position line (or ring) is transferred, the letters TPL are shown beside its

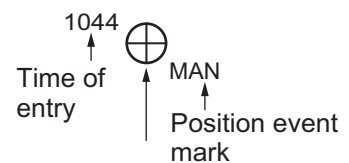

timestamp on the chart. The method of transfer may be selected in the bottom of the dialog. **Transfer to latest** transfers the measurements as if they were all made at the time of the newest measurement. **Continuous transfer** transfers all measurements to real time. **Transfer off** can be used to check where the measurement origins are. The position estimate and the record function follow the same logic, which means that Transfer off shows a position that has no relevance and Transfer to latest sends an old position to the [Voyage] log (timestamp in the log does not match the position).

If you are satisfied with the position shown in the latitude and longitude fields, then click the [Record] button to save the position observation to the Voyage log. If you wish you can also enter latitude and longitude values manually.

Timeouts: The observations cannot be used long after they were made because dead reckoning is inaccurate.

Click the [Record] button to put a position event at the LOP-calculated position. The position is recorded to the [Voyage] log.

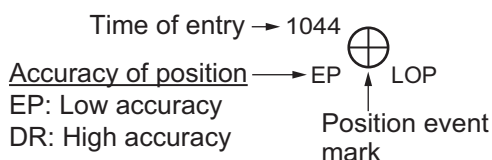

How to find position event information

You can find information about a position event in an ECDIS mode other than Chart maintenance. Put the cursor on the event mark then left click to show the [Event Information] window. This window shows event type (position event), time of entry, event position, name of sensor ([Position] only), comment (automatic for [LOP] and [Position]); user-entered comment* for [Manual]), and position line data ([LOP] only). *Comment cannot be changed from this window.

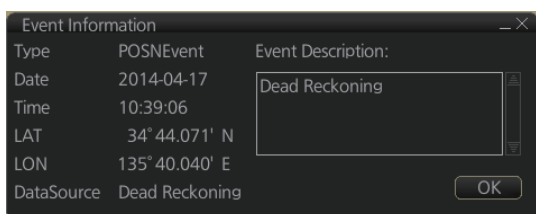

Position event: Position

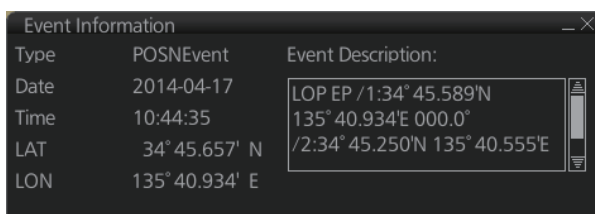

No.	Lat	Lon	Type
1	34° 45.488' N	135° 40.877' E	Bearing
2	34° 45.250' N	135° 40.555' E	Bearing

Position event: LOP

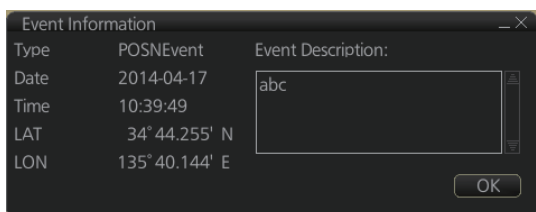

Position event: Manual

19.2 Details Log

The [Details] Log records the voyage information for the last 24 hours. Information is recorded every minute.

- Date of entry
- Time of entry
- Source: No. of unit which generated log
- Type: Type of position data
 - Auto: Automatic input of position
- Latitude, Longitude: Position as output by selected sensor and sensor used as the data source.
- Align/NM, Align/°T: Range, bearing offset, if used
- SOG/kn, COG/°T, S. SRC: Speed over the ground, course over ground and its source
- HDG/°T, S. SRC: Heading data and its source
- CORR/°T: Gyro correction value, if used.

How to view the Details log

On the InstantAccess bar™, click the [Log], [NAV Log] and [Detail] buttons.

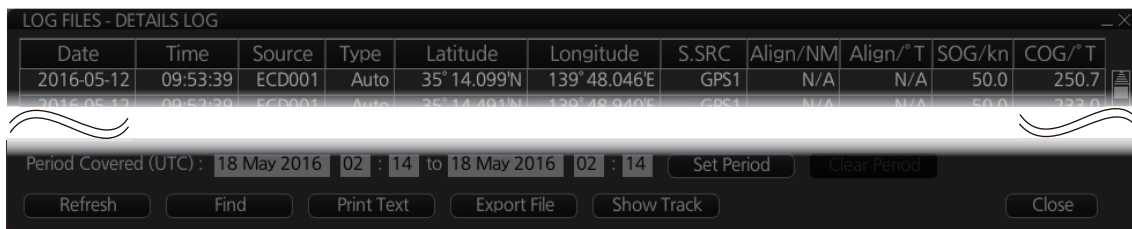

- **To show the logs of a specific period**, enter the period to show with [Period Covered (UTC)] then click the [Set Period] button. Use the [Clear Period] button to display all logs. Log entries outside the set period become gray and the entries inside the set period remain visible. To show log entries which are not visible, spin the scrollwheel upward to scroll up the log, downward to scroll down the log.
- **To refresh the log**, click the [Refresh] button.
- **To search the log**, do as follows:
 - 1) Click the [Find] button to show the [Find text] box.
 - 2) Click the input box then enter the text to search.
 - 3) Select the search direction with the up or down radio button.
 - 4) Click the [Find] button. The first matching text is highlighted in yellow at the top of the screen.
 - 5) To continue the search click the [Find] button. To cancel the search, click the [Cancel] button.
- **To print the log**, click the [Print Text] button. Select printing format then click the [Print] button. [Spread Portrait] prints two pages of data on one page.
- **To show track for the period selected**, click the [Show Track] button. Use the [Hide Track] button to erase the track.
- **To export the log**, click the [Export File] button. The file is named DetailsLogYYYYMMDDhhmmss.csv.

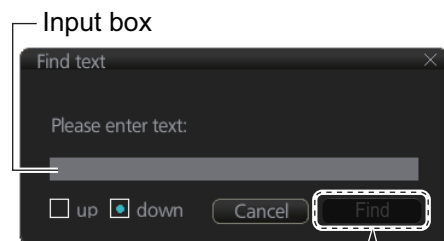

Input text in box and [Find] button appears.

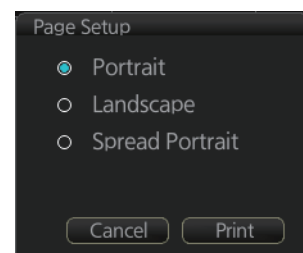

19.3 Voyage Log

The [Voyage] log records all voyage-related data of the past three months. Recorded events are:

- Date: Date of entry
- Time: Time of entry
- Type: Log entry types
 - Auto: Automatic entry of ship position, in 1 to 4 hr intervals, set by operator.
 - Ship: Logged if the amount of change in speed or course equal set values.
 - MOB: MOB position, entered with [MOB] button.
 - User: Operator-entered position. The information entered in the [Description] box is logged.
 - Posdev: Operator-entered GPS position or LOP. The information entered in the [Description] box is logged.

Automatically entered data (Position: data source, LOP: see below.

The latitude and longitude position and bearing (or distance) of a maximum of three objects are automatically recorded to each log entry. An object whose position accuracy is low is not recorded. If an object has both a bearing and distance, separate entries are made.

L/L position, bearing of object (no.1)

```
LOP DR /1:35° 20.743' N 139° 44.925' E 123.4° /2:35° 20.482' N 139° 48.658' E 214.9°
/3:35° 17.437' N 139° 44.820' E 3.07NM
```

- Latitude, Longitude: Position as output by selected sensor and sensor used as the data source.
- SOG/kn, COG/°T, S.SRC: Speed over the ground, course over the ground. and their source
- HDG/°T, S.SRC: Heading and its source
- CORR/°T: Offset bearing, if used
- Wind/kn Wind/°T: Wind speed and angle
- Dist/NM: Navigation distance
- Depth/m: Depth in meters
- Description: Show recorded contents, for [User], [PosDev] above.

If desired items other than [Posdev] can be edited. Click an item to show the [Edit Description] box. Edit the description as required then click the [OK] button.

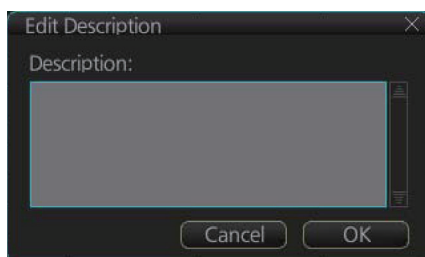

How to view the Voyage log

Click the [Record], [NAV Log] and [Voyage] buttons on the InstantAccess bar.

Date	Time	Source	Type	Latitude	Longitude	S.SRC	SOG/kn	COG/°T	S.SRC
30.05.2013	15:38:18	ECD001	Auto	47° 30.529'N	065° 27.930'W	19.9	243.3	243.2	LOG1
30.05.2013	13:29:08	ECD002	Auto	47° 43.856'N	064° 27.605'W	20.0	260.4	260.4	LOG1

Period Covered (UTC) : 29 May 2013 19 : 38 to 29 May 2013 19 : 38

Buttons: Refresh, Find, Print Text, Export File, Show Track, Close

- **To show the logs of a specific period**, enter the period to show with [Period Covered (UTC)] then click the [Set Period] button. Use the [Clear Period] button to display all logs. Log entries outside the set period become gray and the entries inside the set period remain visible. To show log entries which are not visible, spin the scrollwheel upward to scroll up the log, downward to scroll down the log.
- **To refresh the log**, click the [Refresh] button.
- **To search the log**, do as follows:
 - 1) Click the [Find] button to show the [Find text] box.
 - 2) Click the input box then enter the text to search.
 - 3) Select the search direction with the up or down radio button.
 - 4) Click the [Find] button. The first matching text is highlighted in yellow at the top of the screen.
 - 5) To continue the search click the [Find] button. To cancel the search, click the [Cancel] button.
- **To print the log**, click the [Print Text] button. Select printing format then click the [Print] button.
- **To show track for the period selected**, click the [Show Track] button. Use the [Hide Track] button to erase the track.
- **To export the log**, click the [Export File] button. The file is named VoyageLogYYYYMMDDhhmmss.csv.

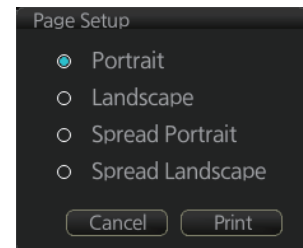

19.3.1 How to set conditions for voyage logging

The operator can set the conditions for automatic voyage logging (logging interval only). When the following conditions are met, data is stored into the Voyage log.

- Speed (or course) change is equal to the set value.
- The logging interval time has elapsed.

To set the conditions of logging, do as follows:

1. Open the menu and select [Log], [NAV Log] and [Voyage] to show the [Voyage] menu.
2. Set the logging interval (1 - 4 hr, 1 hr increment).
3. Click the [Save] button to save the settings, then click the [Close] button to finish.

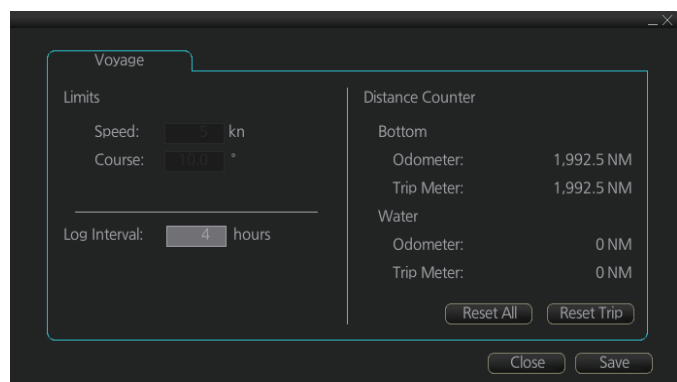

19.4 Chart Usage Log

The [Chart Usage] log stores which charts were used on the ECDIS display. To open the log, click [Log], [NAV Log] and [Chart Usage] on the InstantAccess bar™. The following information is recorded in the chart usage log:

- Date and time chart was displayed
- Chart ID
- Center position of display (Lat, Lon)
- Chart source
- Chart edition
- Display scale
- Compilation scale
- The latest update included to chart
- Chart base

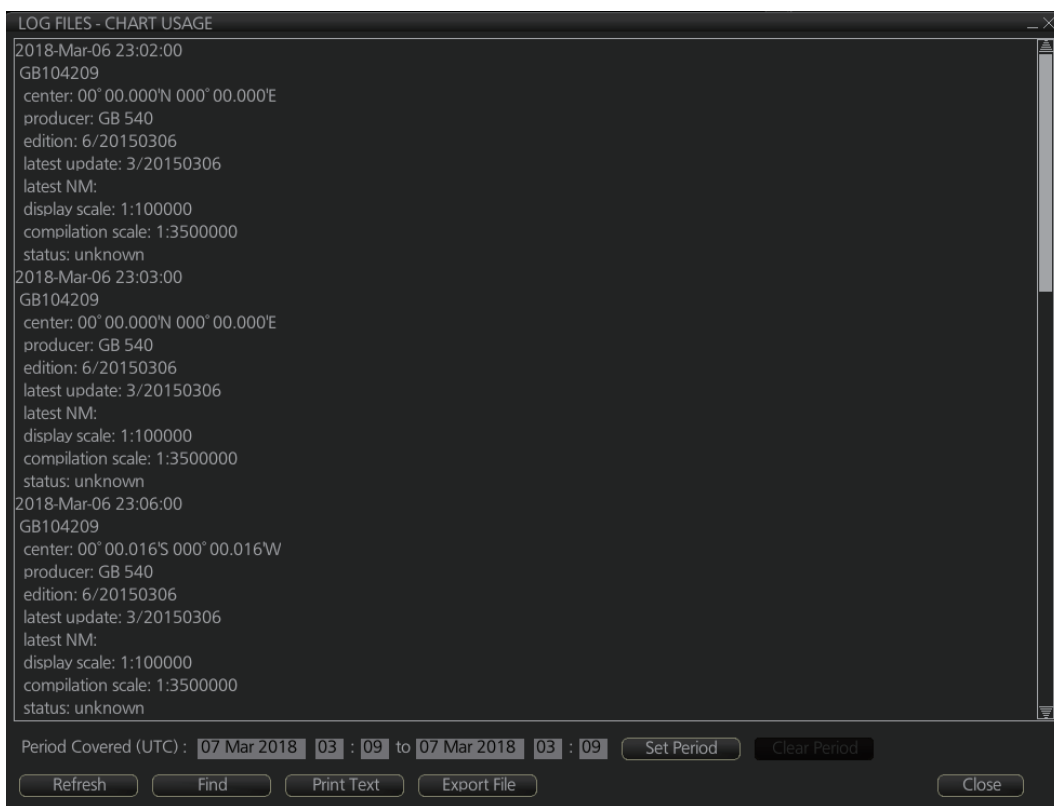

- **To show the logs of a specific period**, enter the period to show with [Period Covered (UTC)] then click the [Set Period] button. Use the [Clear Period] button to display all logs.
- **To refresh the log**, click the [Refresh] button.
- **To search the log**, do as follows:
 - 1) Click the [Find] button to show the [Find text] box.
 - 2) Click the input box then enter the text to search.
 - 3) Select the search direction with the up or down radio button.
 - 4) Click the [Find] button. The first matching text is highlighted in yellow at the top of the screen.
 - 5) To continue the search click the [Find] button. To cancel the search, click the [Cancel] button.
- **To export the log**, click the [Export File] button. The file is named ChartUsageLogYYYYMMDDhhmmss.txt
- **To print the log**, click the [Print Text] button.

19.5 Danger Targets Log

The [Danger Targets] log stores information about dangerous targets (CPA/TCPA alarm) that are received from a radar (TTs) and/or AIS targets received from an AIS transponder.

If a TT or AIS target is within the set CPA (Closest Point of Approach) and TCPA (Time to CPA), information of all TTs (including non-dangerous targets) are recorded into the danger target log. This data is as follows:

- Date: Date of entry
- Time: Time of entry
- Source: Unit which generated log
- Type: Type of dangerous target (TT or AIS)
- Target ID: When [Type] is [TT] - Dangerous target's number
When [Type] is [AIS] - MMSI number
- Latitude and Longitude: Latitude and longitude position of dangerous AIS target or TT
- SPD/kn: Speed of dangerous AIS target or TT
- CRS/°T: Course of dangerous AIS target or TT
- HDG/°T: Heading of dangerous AIS target or TT
- CPA/NM, TCPA/min: CPA and TCPA of dangerous AIS target or TT

How to view the danger targets log

On the InstantAccess bar™, click the [Log], [Target Log] and [Danger Target] buttons.

Date	Time	Source	Type	Target ID	Latitude	Longitude	SPD/kn	CRS/°T	HDG/°T	CPA/NM
2016-05-12	13:55:59	ECD001	TT	01	35°38.164'N	139°49.842'E	15.1	193.3	N/A	1.3

- **To show the logs of a specific period**, enter the period to show with [Period Covered (UTC)] then click the [Set Period] button. Use the [Clear Period] button to display all logs. Log entries outside the set period become gray and the entries inside the set period remain visible. To show log entries which are not visible, spin upward to scroll up the log, downward to scroll down the log.
- **To refresh the log**, click the [Refresh] button.
- **To search the log**, do as follows:
 - 1) Click the [Find] button to show the [Find text] box.
 - 2) Click the input box then enter the text to search.
 - 3) Select the search direction with the up or down radio button.
 - 4) Click the [Find] button. Matching text is highlighted in yellow at the top of the screen.
 - 5) To continue the search click the [Find] button. To cancel the search, click the [Cancel] button.
- **To print the log**, click the [Print Text] button. Select printing format then click the [Print] button.
- **To export the log**, click the [Export File] button. The file is named DangerTargetLogYYYYMMDDhhmmss.csv.

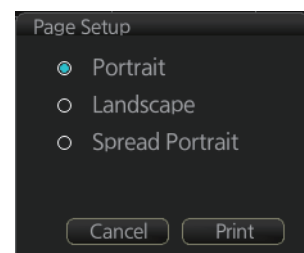

19.5.1 How to filter the dangerous targets log

You can filter the dangerous targets log by CPA or TCPA. When a TT or AIS target's CPA or TCPA is lower than the setting here, the target's details are automatically logged.

To set the filter, do the following:

1. Open the menu and select [Log], [Target Log] and [Danger Target] to show the [Danger Targets] menu.

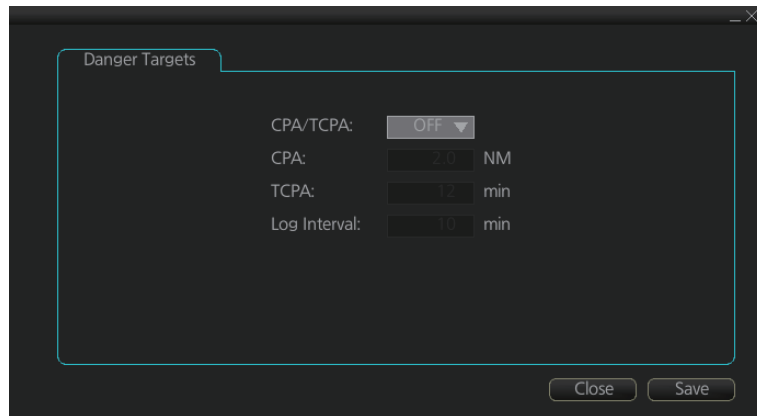

2. At [CPA/TCPA], select [ON].
3. At [CPA], set the distance for the CPA.
4. At [TCPA], set the time for the TCPA.
Note: [Log Interval] is fixed at 10 minutes.
5. Click [Save] to save the settings, then click [Close] to close the menu.

19.6 Route Transfer Log

The [Route Transfer] log keeps a tab of sent and received route-related communications. When one or more of the following conditions are met, an entry is made in the [Route Transfer] log.

- RRT sentence is sent from this system.
- RRT sentence is received by this system.
- A sent RRT sentence is not acknowledged by an external device.

The log data includes the following:

- Date: Date of entry
- Time: Time of entry
- Communication Type: Send, Receive or No Response
- Source: UID of route related communication
- Destination: UID of destination of route related communication
- Detail: Content of transfer
- Transfer Type: Type of communication - Monitor route, Plan route, or Query
- Transfer Name: Name of transferred route
- Transfer Version: Transferred route's version
- Current WPT: Current waypoint
- Transfer Status: Current transfer status of the transferred route
- Application Status: Current status of the transfer application

How to view the route transfer log

On the InstantAccess bar™, click the [Log], [Target Log] and [Route TRANS Log] buttons

Date	Time	Communication Type	Source	Destination	Detail	Transfer Type
2007-06-02	21:26:56	Send	EI0002	*****	Information request.	Query
2007-06-02	15:39:47	Receive	EI0001	EI0002	Success.	Plan route

Period Covered (UTC) : 05 Apr 2016 00 : 43 to 05 Apr 2016 00 : 43

Buttons: Refresh, Find, Print Text, Export File, Close

- **To show the logs of a specific period**, enter the period to show with [Period Covered (UTC)] then click the [Set Period] button. Use the [Clear Period] button to display all logs. Log entries outside the set period become gray and the entries inside the set period remain visible. To show log entries which are not visible, spin upward to scroll up the log, downward to scroll down the log.
- **To refresh the log**, click the [Refresh] button.
- **To search the log**, do as follows:
 - 1) Click the [Find] button to show the [Find text] box.
 - 2) Click the input box then enter the text to search.
 - 3) Select the search direction with the up or down radio button.
 - 4) Click the [Find] button. Matching text is highlighted in yellow at the top of the screen.
 - 5) To continue the search click the [Find] button. To cancel the search, click the [Cancel] button.
- **To print the log**, click the [Print Text] button. Select printing format then click the [Print] button.
- **To export the log**, click the [Export File] button. The file is named RouteTransferLogYYYYMMDDhhmmss.csv.

19.7 How to Playback the Log

The log can be played back to check ship's movements within a given time frame.

Cautions for data recording, playback

- In rare cases, data may be corrupted when recorded.
 - The most recent playback data (max. last 10 minutes) is not saved in an unintentional power outage or a system restart. If the power was turned off with the power key on the Control Unit, the playback data which was present until the power was turned off is saved.
 - Playback is not available when unacknowledged alerts exist.
1. On the Status bar, click the [OTHERS] and [Playback] buttons. A confirmation message appears to inform you that, during playback, the logging function and alert handling function are not available. Click the [OK] button to proceed. The window shown below appears.

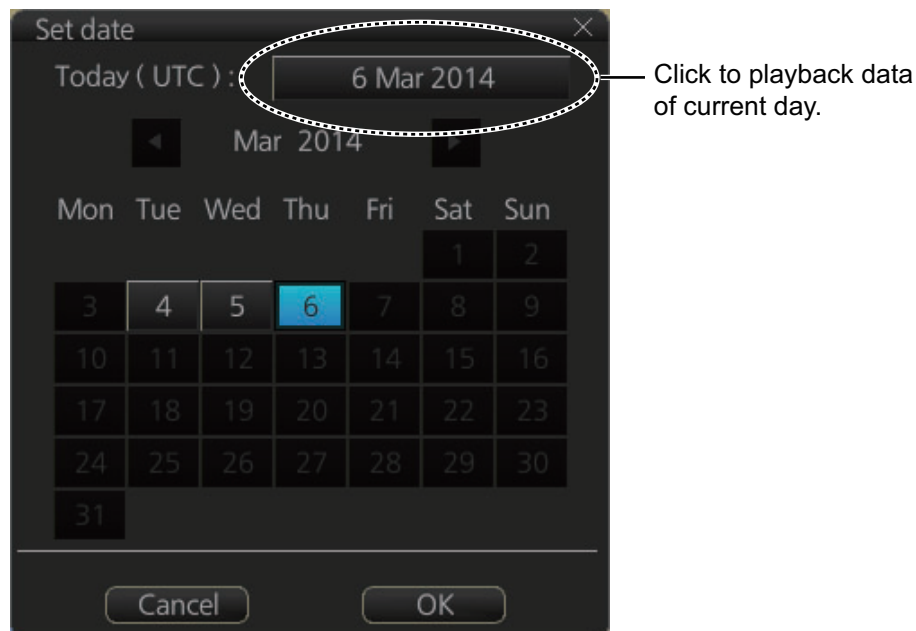

2. Select the date to playback. Log data is stored by the day. To play back data in the current month, click a day in the calendar. For other dates, click the [◀] or [▶] button to select the month and then click a day in the calendar. To playback the current day, click the button at the top of the screen.
3. Click the [OK] button, and the dialog box shown on the next page appears. This box has controls for
 - Start and End times
 - Time elapsed
 - Slider bar (drag the bar to change start time)
 - Playback speed list box (change the playback speed). The choices are x1, x2, x4, x10 and x60.

- The [Select] button selects a file. Playback is stopped and a message asks if you are sure to select a different file.

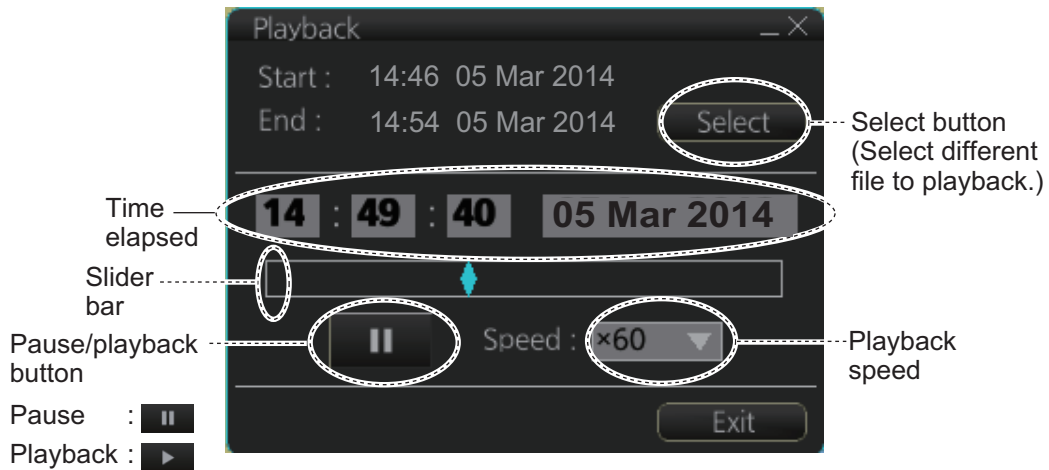

All your ship's movements and chart-related operations during the time period selected are plotted on the screen and the screen shows the message "PLAYBACK". To stop playback and return to the normal display, click the [Exit] button. The message "Please Restart ECDIS for using other functions without playback." appears. Click the [Restart] button to restart ECDIS.

19. RECORDING FUNCTIONS, PLAYBACK FUNCTIONS

This page is intentionally left blank.

20. ALERTS

This chapter describes how the internal alert system works. For a complete list of alerts, See Appendix 4.

20.1 What is an Alert?

"Alert" is a generic name for a notice to any unusual or potentially dangerous situation generated within the system.

Alerts are classified according to priority and category.

Alert priority

There are four alert priorities: emergency*, alarm, warning and caution.

* Generated when this ECDIS is connected to the AMS (Alert Management System, scheduled for future release).

Emergency: Immediate danger to human life or to the ship and its machinery exists and that immediate action must be taken. **Emergency alerts are handled the same as an alarm.**

Alarm: Situations or conditions which require immediate attention, decision and (if necessary) action by the bridge team to avoid any kind of hazardous situation and to maintain the safe navigation of the ship.

Warning: Conditions or situations which require immediate attention for precautionary reasons, to make the bridge team aware of conditions which are not immediately hazardous, but may become so.

Caution: Awareness of a condition which continues to require attention out of the ordinary consideration of the situation or of given information.

Alert category

An alert is further classified by category, A, B or C, according to its degree of severity or source.

Category	Description
A	Category A alerts include the following, and must be confirmed from the equipment that generated the alert. <ul style="list-style-type: none">• Danger of collision• Danger of grounding
B	Category B alerts are alerts where no additional information for decision support is necessary. Category B alerts are all alerts not falling under category A.
C	IAS (Integrated Automation System) generated engine alert

20.2 Alert Box

When an alert is generated, the related alert message and alert state icon appear in the [Alert] box, which is at the bottom right corner on the screen. An audible alarm is additionally generated for emergencies, alarms and warnings.

In addition to the alert message and alert state icon, the [Alert] box provides access to the [Alert List] and [Alert Log].

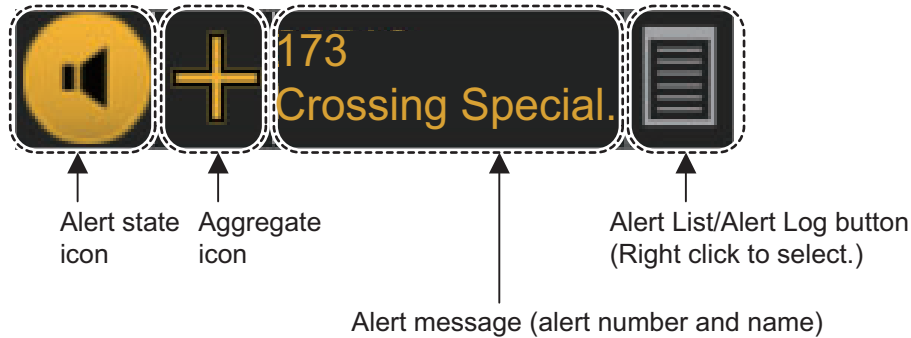

Aggregate icon: The aggregate icon indicates an alert within an alert group and is accompanied with the [Emergency], [Alarm], [Warning] or [Caution] icon. The aggregate alert name appears in the Alert box. You can click the icon to confirm and acknowledge the corresponding alert. See section 20.3 for details.

Alert state icon: The state of an alert is shown with an icon. See "Alert state icons" on page 20-4.

Alert message: The alert message area shows the name of the alert having the highest priority of the generated alerts together with the alert number. The color of the characters and the background changes according to alert priority and alert state. You can enlarge the text by putting the cursor in the area.

An alert can be acknowledged from the [Alert] box or [Alert List]. An alert remains in the [Alert] box and [Alert List] until it is acknowledged and rectified. See section 20.5.





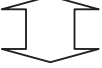
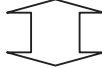









Alert List/Alert Log button: Right-click to select [Alert List Window] or [Alert Log Window]. The background color of the button is light blue when the list or log is open. See section 20.6 and section 20.7 for a description of the list and log.

Alert message display format

Alert indication	Priority of alert	Alert state	Display state
<div style="background-color: red; color: black; padding: 2px; display: inline-block;">172 Off Track Alarm</div>  Displayed alternately <div style="background-color: black; color: red; padding: 2px; display: inline-block;">172 Off Track Alarm</div>	Emergency, Alarm	- Not acknowledged, Not rectified. OR - Not acknowledged, Rectified.	Black characters on red background. (Flashing) Red characters on gray background.
<div style="background-color: black; color: red; padding: 2px; display: inline-block;">172 Off Track Alarm</div>	Emergency, Alarm	Acknowledged, Not rectified.	Red characters on gray background.
<div style="background-color: orange; color: black; padding: 2px; display: inline-block;">30510 No Filter Source</div>  Displayed alternately <div style="background-color: black; color: orange; padding: 2px; display: inline-block;">30510 No Filter Source</div>	Warning	- Not acknowledged, Not rectified. OR - Not acknowledged, Rectified.	Black characters on yellow-orange. (Flashing) Yellow-orange characters on gray background.
<div style="background-color: black; color: orange; padding: 2px; display: inline-block;">30510 No Filter Source</div>	Warning	Acknowledged, Not rectified.	Yellow-orange characters on gray background.
<div style="background-color: black; color: yellow; padding: 2px; display: inline-block;">30400 Wind Direction/Wind</div>	Caution	Not rectified.	Yellow characters on gray background.
<div style="background-color: black; height: 20px; width: 100%;"></div>	Emergency, Alarm, Warning	Acknowledged, Rectified.	No display.
<div style="background-color: black; height: 20px; width: 100%;"></div>	Caution	Rectified.	No display.

Alert state icons

The table shows the icons used to indicate the different alert states for the emergency, alarm, warning and caution alerts.

No.	Icon	Alert state	Description
Emergency, Alarm alert			
1		Active - unacknowledged alarm	Red triangle with black loudspeaker in center of triangle. Flashing (on 1 s, off 1 s).
2		Active - silenced alarm	Red triangle with crossed out black loudspeaker in center of triangle. Flashing (on 1 s, off 1 s).
3		Active - acknowledged alarm	Steadily displayed red triangle with black exclamation point in center of triangle.
4		Active - responsibility transferred alarm	Steadily displayed red triangle. Right arrow at center. Presented together with alert text.
5		Rectified - unacknowledged alarm	Red triangle with black check mark in center of triangle. Flashing (on 1 s, off 1 s).
Warning alert			
6		Active - unacknowledged warning	Yellow-orange circle with black loudspeaker in center of circle. Flashing (on 1 s, off 1 s).
7		Active - silenced warning	Yellow-orange circle with crossed out black loudspeaker in center of circle. Flashing (on 1 s, off 1 s).
8		Active - acknowledged warning	Steadily displayed yellow-orange circle with black exclamation point in center of circle.
9		Active - responsibility transferred warning	Steadily displayed yellow-orange circle. Right arrow at center. Presented together with alert text.
10		Rectified - unacknowledged warning	Yellow-orange circle with black check mark in center of circle. Flashing (on 1 s, off 1 s).
Caution alert			
11		Caution	Yellow square. Exclamation mark at center. Presented together with alert text.
Other icons			
12		Aggregation	Plus sign. Presented together with the icon numbers 1 - 11.
13		Acknowledge not allowed for alarm	Red triangle. Cross in center of triangle. Presented together with icon numbers 1, 2 and 5.
14		Acknowledge not allowed for warning	Yellow-orange circle. Cross in center of circle. Presented together with icon numbers 6, 7 and 10.

20.3 Aggregated Alerts

MSC302(87) requires the use of the “aggregated alert,” which groups multiple similar alerts.

The illustration below shows the grouping possible with the FURUNO AMS. Grouped alerts can be collectively temporarily silenced.

Grouping of similar alerts with a single sensor

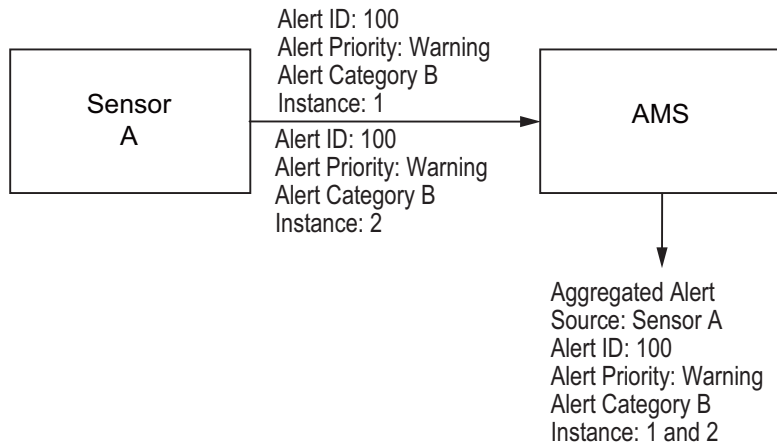

Grouping of similar alerts with multiple sensors

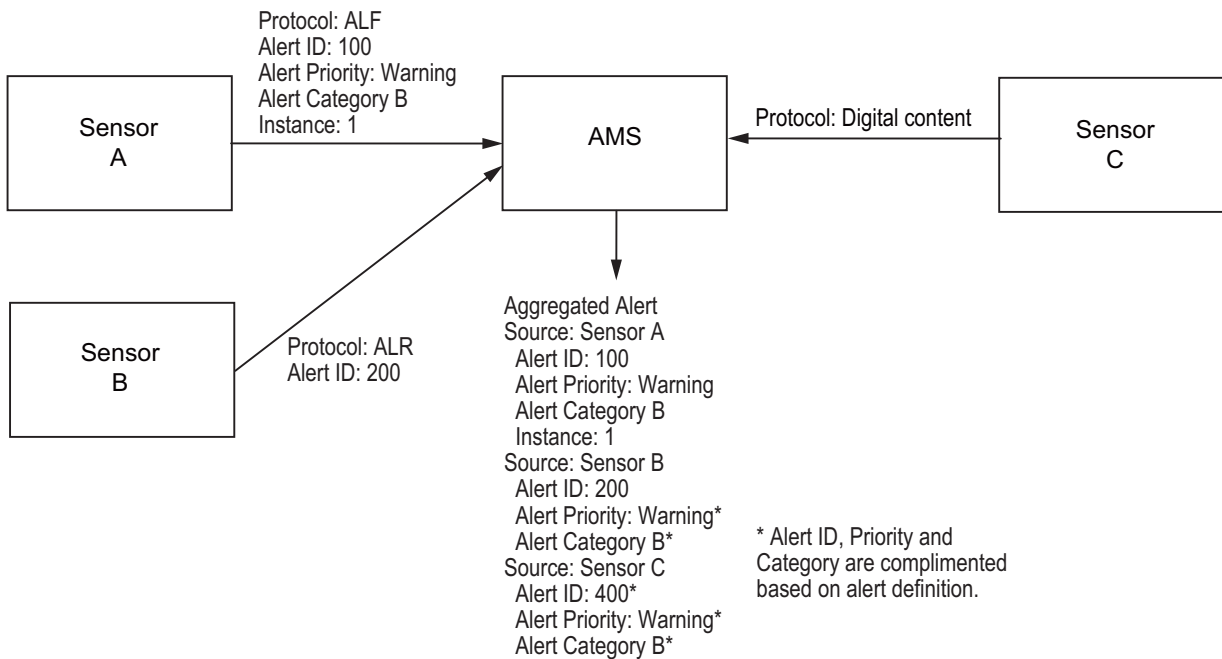

Grouping is done when the equipment is installed, and has these limitations.

- Grouped alerts cannot be collectively acknowledged. Each alert must be individually acknowledged.
- The alerts must all have the same alert priority and alert category. Alerts having different alert priority and alert category cannot be grouped.

20.4 How to Temporarily Silence the Buzzer for an Alarm or Warning

When the buzzer for an Emergency, Alarm or Warning sounds, you can temporarily silence it by clicking the [Silence] button in the [Alert] list.

The buzzer stops, however, the alert message remains in the [Alert] box and [Alert] list until acknowledged and rectified.

20.5 How to Acknowledge an Alarm or Warning

When an alarm or warning is generated, the buzzer sounds and the name of the alert appears and flashes in the [Alert] box and [Alert] list. To acknowledge the alert, do one of the following:

- Operate the **ALARM ACK** key on a Control Unit.
- In the [Alert] box, click the alert name (non-aggregate only).
- In the [Alert] list, click the alert name or click the [ACK] button. For an aggregate alert, click the [ACK] button in the [Aggregation] window.

When acknowledged, the buzzer stops and the flashing of the alert name stops. The state of the alert changes and the alert priority changes as shown below

Priority No.	Priority of Alert	Alert state	
High ↑ ↓ Low	1	Emergency, Alarm	Not acknowledged, Not rectified
	2	Warning	Not acknowledged, Not rectified
	3	Emergency, Alarm	Not acknowledged, Rectified
	4	Warning	Not acknowledged, Rectified
	5	Emergency, Alarm	Acknowledged, Not rectified
	6	Warning	Acknowledged, Not rectified
	7	Caution	Not rectified

Category of alert and place of alert acknowledgement

The place of alert acknowledgement depends on the category of the alert.

Category	Where alert notification occurs	Place of alert acknowledgement
A	Equipment that generated the alert and AMS* (Alert Management System, scheduled for future release).	Equipment that generated the alert.
B	Equipment that generated the alert and AMS.	Equipment that generated the alert or AMS.
C	IAS (Integrated Automation System) generated engine alert.	—

*: A category A alert does not sound at the AMS.

20.6 Alert List

The [Alert List] displays all active alerts, with unacknowledged alerts at the top, in priority order. To display the list, right-click the [Alert List/Alert Log] button in the [Alert] box then select [Alert List]. The ZDA sentence is required to display the time in the list.

The list shows:

- Alert no., alert instance
- Alert name
- Source of alert
- Time (UTC) alert was generated
- Time (UTC) alert was acknowledged
- Details about the alert selected
- Quantity of unacknowledged alerts

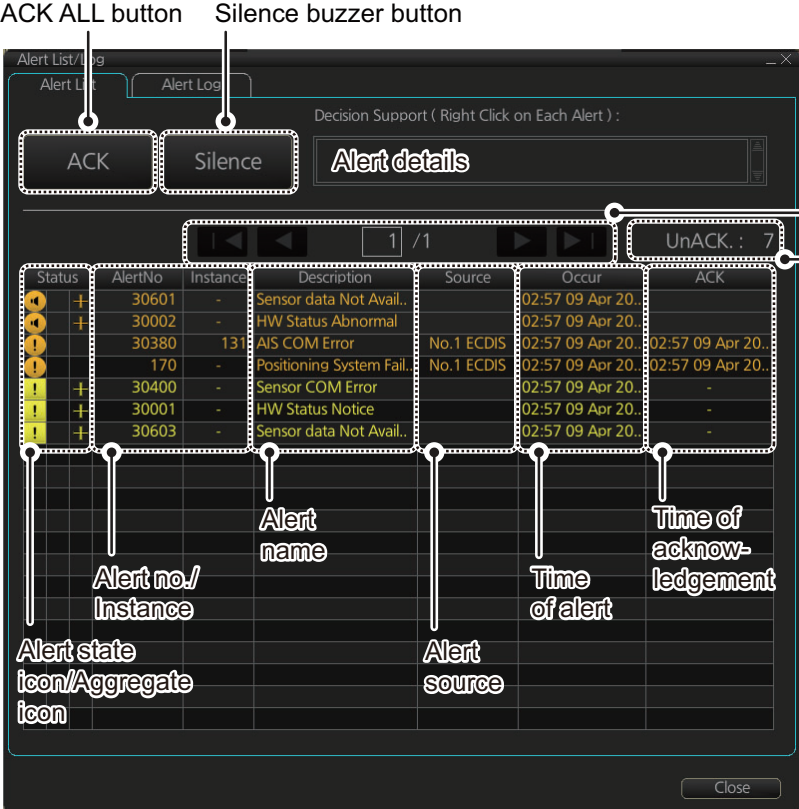

Page selection buttons
Click to select page. Available only when multiple pages exist.
 ▶ : Show next page
 ▶ | : Jump to last page
 ◀ : Show previous page
 | ◀ : Jump to first page

No. of unacknowledged alerts
If there are no unacknowledged alerts, "0" is shown.

The background color changes according alert state as follows.

- Unacknowledged alert (flashing display):** Emergency, Alarm, red; Warning, Bright yellow
- Acknowledged alert (steady display):** Emergency, Alarm, red; Warning, Bright yellow; Caution, yellow

The Alert status column shows the following:

- Left: Alert icon for Emergency, Alarm, Warning, Caution is shown. See 1-11 on page 20-4.
- Center: Alert icon for Emergency, Alarm, Warning is shown. See 13, 14 on page 20-4.
- Right: Aggregate icon is shown. See page 20-4. Blank if no active aggregate alert.

To find details about an alert, right-click the applicable alert. See the detailed information in the [Decision Support] box at the top of the screen.

The [ACK] button acknowledges the alert at the top of the Alert list. Emergency, Alarm, and Warning categories can be acknowledged by clicking them in the list.

20. ALERTS

The [Silence] button silences the buzzer.

The [Aggregation] window can be shown by clicking an aggregate icon. The window can also be opened by clicking an aggregate icon in the [Alert] box. Unacknowledged aggregate alerts can be acknowledged by clicking the [ACK] button.

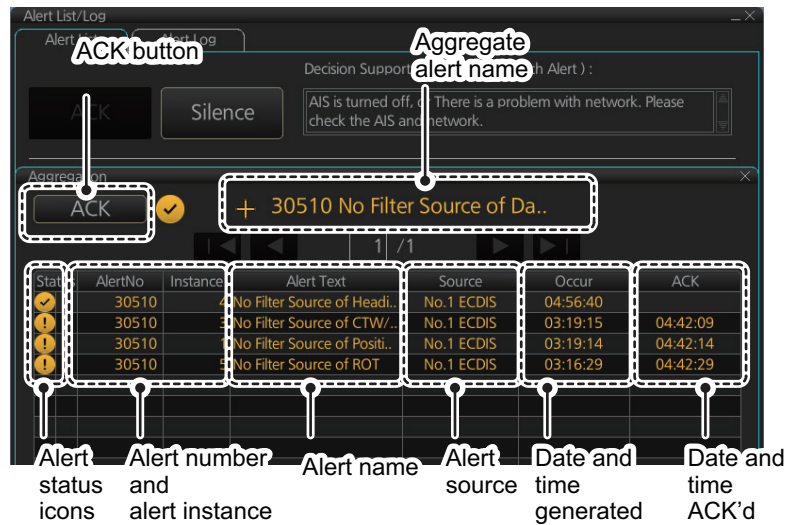

How the alert list is updated after acknowledgement, rectification

When you acknowledge an alert, its display method on the [Alert] list changes according to alert category and alert state. Acknowledged and rectified alerts are immediately removed from the list.

No.	Alert priority	Alert state	Display after acknowledgement	Display after rectifying
1	Alarm	Not acknowledged, Not rectified	5	2
2		Not acknowledged, Rectified	8	–
3	Warning	Not acknowledged, Not rectified	6	4
4		Not acknowledged, Rectified	9	–
5	Alarm	Acknowledged, Not rectified	–	8
6	Warning	Acknowledged, Not rectified	–	9
7	Caution	Not rectified	–	10
8	Alarm	Acknowledged, Rectified	–	–
9		Acknowledged, Rectified	–	–
10	Caution	Rectified	–	–

20.7 Alert Log

The [Alert Log] stores and displays the latest 10,000 alerts. To display the log, right-click the [Alert List/Alert Log] button then select [Alert Log Window]. The log shows the following information for each alert:

- Priority of alert (Emergency, Alarm, Warning, Caution)
- Category of alert (A, B or C)
- Alert no., instance
- Alert name
- Source of alert
- Occurred Time (UTC)
- Time ACKed (UTC)
- Time rectified (UTC)
- Time silenced (UTC)
- Time of transfer of authority to AMS (UTC)* *: scheduled for future release

You can select what priority and category of alerts to display with the [Priority] and [Category] filters at the top of the list. The log can be sorted by [Priority], [Cat.], [Description] or [Occurred Time]. Click the corresponding column title to sort accordingly. To search the log, enter text in the [Log Search] box then click the [Find] button. You can erase the contents of the [Log Search] box by clicking the [Reset] button. You can save the contents of the log to a USB flash memory, in .dat format, by clicking the [Export Log] button.

Priority filter

Category filter

Page navigation buttons
When more than one page exists:
▶ : Go to next page.
▶| : Go to last page.
◀ : Go to previous page.
|◀ : Go to first page.

Scroll right to view:
- Time acknowledged
- Time rectified
- Time silenced
- Time of transfer of authority to AMS

Priority	Cat.	AlertNo	Instance	Description	Source	Occurred Time(UTC)
Warning	A	173	1	Marine Farm / Aquaculture	No.1 ECDIS	05:24:54 20 Jul 2016
Warning	A	30173	-	UKC Limit	No.1 ECDIS	05:24:40 20 Jul 2016
Warning	A	173	1	Marine Farm / Aquaculture	No.1 ECDIS	05:20:13 20 Jul 2016
Alarm	A	171	-	Crossing Safety Contour	No.1 ECDIS	05:18:34 20 Jul 2016
Warning	A	173	-	Restricted Area	No.1 ECDIS	05:17:33 20 Jul 2016
Warning	B	30510	-	No Filter Source of Heading	No.1 ECDIS	05:17:01 20 Jul 2016
Warning	A	173	-	Caution Area	No.1 ECDIS	05:16:56 20 Jul 2016
Warning	B	30510	-	No Filter Source of Heading	No.1 ECDIS	05:15:27 20 Jul 2016
Warning	A	30173	-	UKC Limit	No.1 ECDIS	05:15:20 20 Jul 2016
Caution	A	30860	-	Navigational Hazard	No.1 ECDIS	05:13:14 20 Jul 2016
Alarm	A	171	-	Crossing Safety Contour	No.1 ECDIS	05:13:00 20 Jul 2016
Alarm	A	171	-	Crossing Safety Contour	No.1 ECDIS	05:12:45 20 Jul 2016
Warning	A	173	-	Restricted Area	No.1 ECDIS	05:10:53 20 Jul 2016
Warning	A	173	-	Caution Area	No.1 ECDIS	05:10:45 20 Jul 2016
Warning	A	173	1	Marine Farm / Aquaculture	No.1 ECDIS	05:04:33 20 Jul 2016
Warning	A	30173	-	UKC Limit	No.1 ECDIS	05:04:17 20 Jul 2016
Warning	A	30173	-	UKC Limit	No.1 ECDIS	05:04:13 20 Jul 2016
Warning	A	173	1	Marine Farm / Aquaculture	No.1 ECDIS	04:59:51 20 Jul 2016
Warning	A	30173	-	UKC Limit	No.1 ECDIS	04:58:14 20 Jul 2016

Priority **Category** **Alert name** **Date and time generated**

Alert number and alert instance Alert source

20.8 Alert Reception from Connected Sensors

An "ALR receive and ACK transmit" communication is available for every serial line input. The ALR message from the sensor includes information about alerts from the sensor, and is presented through the normal alert system. When you acknowledge an alert, an ACK message is sent to the sensor to do remote acknowledge.

This interface is based on IEC 61162-1 and IEC 80/520/INF.

21. PARAMETERS

21.1 Ship and Route Parameters

The purpose of the ship and route parameters is set the basic parameters for the ship. These parameters are relative to ship steering and they are very important to get correct function of the integrated navigation system. They must be maintained carefully. Modification requires a good knowledge of the parameters' importance.

Open the menu and select [Ship & Route Parameters] from the [General] menu to show the [Ship & Route] page. Set each item referring to the description below.

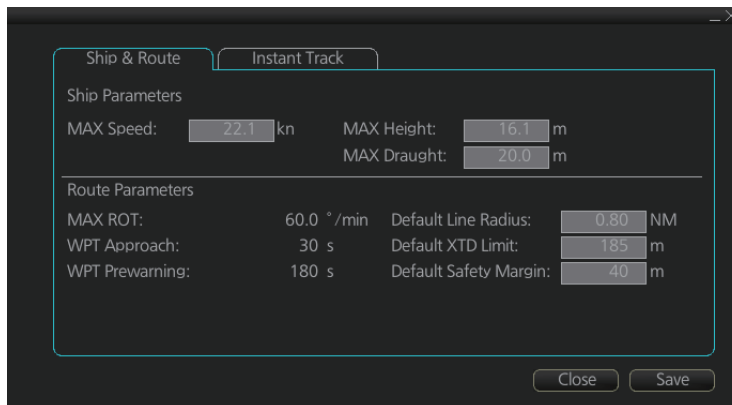

Ship Parameters description

[MAX Speed]: Maximum speed the ship can do.

[MAX Height]: Maximum height of ship above sea level.

[MAX Draught]: Maximum draught of ship.

Route Parameters description

[MAX ROT]*: The maximum rate of turn of the ship. Set at installation.

[WPT Approach]*: The alert time before reaching the wheel over point.

[WPT Prewarning]*: The alert time before reaching the wheel over point.

[Default Line Radius]: Define the default value of radius between waypoints during automatic route steering.

[Default XTD Limit]: Define the channel (XTD) limit.

[Default Safety Margin]: Define the default value of extension for channel limits to be checked against chart alerts.

* Set at installation. Not adjustable by the operator.

21.2 Forwarding Distances

The forwarding distances are the distances the ship travels straight after the steering command is given to the autopilot. These distances change according to the radius of turn.

The forwarding distances are entered at installation and cannot be changed by the operator. However, the operator can view the forwarding distances settings on the [Forwarding Distance] display ([MENU]→[General]→[Navigation Parameter]).

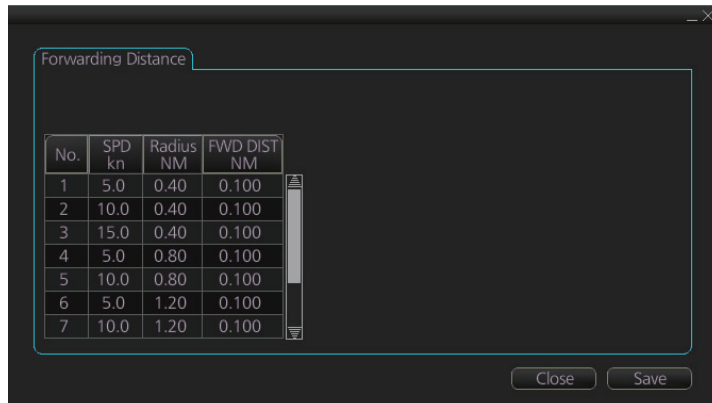

No.	SPD kn	Radius NM	FWD DIST NM
1	5.0	0.40	0.100
2	10.0	0.40	0.100
3	15.0	0.40	0.100
4	5.0	0.80	0.100
5	10.0	0.80	0.100
6	5.0	1.20	0.100
7	10.0	1.20	0.100

Note: These are the port side values. Starboard side values can also be shown. Contact a FURUNO dealer for details.

21.3 Cost Parameters

The cost parameters are used in the optimization calculation. Therefore define these parameters before doing the calculation.

Open the menu and select [Cost Parameters] from the [General] menu to show the [Cost Parameters] page. Set each item according to ship's plan, etc.

Speed kn	Heavy Fuel Oil ton/h	Diesel Oil ton/h
0.0	0.000	0.000
0.0	0.000	0.000
0.0	0.000	0.000
0.0	0.000	0.000
0.0	0.000	0.000
0.0	0.000	0.000
0.0	0.000	0.000
0.0	0.000	0.000
0.0	0.000	0.000
0.0	0.000	0.000
0.0	0.000	0.000
0.0	0.000	0.000

At the [Cost] window, enter the cost/hour and cost/ton for heavy fuel oil and diesel oil. At the [Fuel Consumption] window, define the fuel consumption figures for up to 12 different speeds. Before entering the data, plot the data on a graph, like the one shown below. Use a second graph if, for example, diesel oil consumption is different from that of heavy fuel oil. Reset the power to effect the settings.

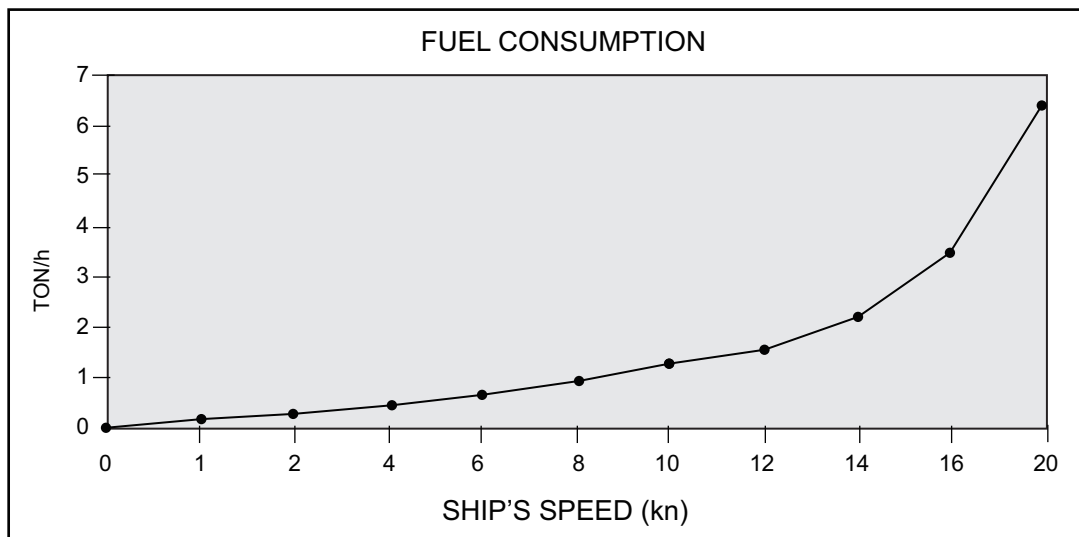

21.4 Instant Track Parameters

The instant track feature can create, in route monitoring, a simple route in the following situations:

- Return to the monitored route when the vessel goes outside the channel limits.
- Temporarily deviate from the monitored route (avoid collision, etc.).

How to set instant track parameters

Set the parameters for the instant track ([MENU]→[General]→[Ship & Route Parameters]→[Instant Track] tab).

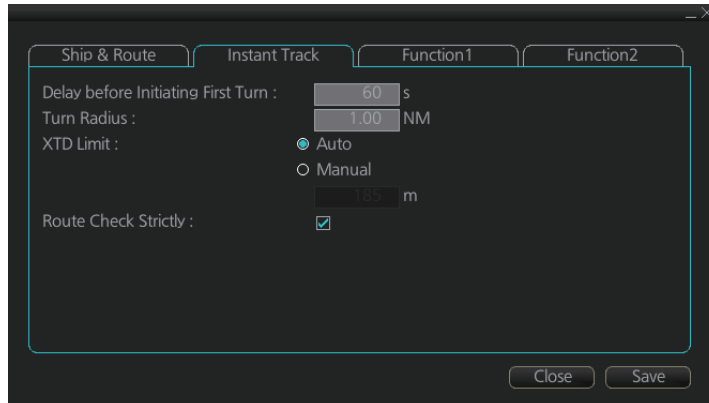

[Delay before Initiating First Turn]: Set the number of seconds (30 to 600 seconds) to wait before initiating the first turn in the simple route.

[Turn Radius]: Set the turning radius (0.02 to 3.00 NM) to use between waypoints (four waypoints) in the simple route.

[XTD Limit]: Set the channel limit (10 to 3704 m) for the instant track, automatically or manually. The [Auto] setting uses the channel limit set for the monitored route.

[Route Check Strictly]: Check to prevent monitoring of instant track when a chart alert (alarm or warning) is found through the route check. Uncheck to monitor instant track in spite of chart alert found through the route check.

22. SETTINGS MENU

The [Settings] menu provides file import, export and maintenance, alert setting, testing facilities (display, Trackball Control Unit, keyboard (option), self test), data sharing, customizing, screenshot processing, user default restoration, and CCRP selection.

22.1 How to Access the Settings Menu

Click the Settings button () on the Status bar then select [Settings]. The right message appears.

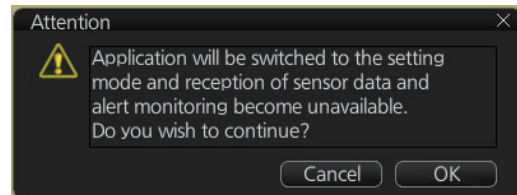

Click the [OK] button to show the [Settings] menu then click the [OK] button.

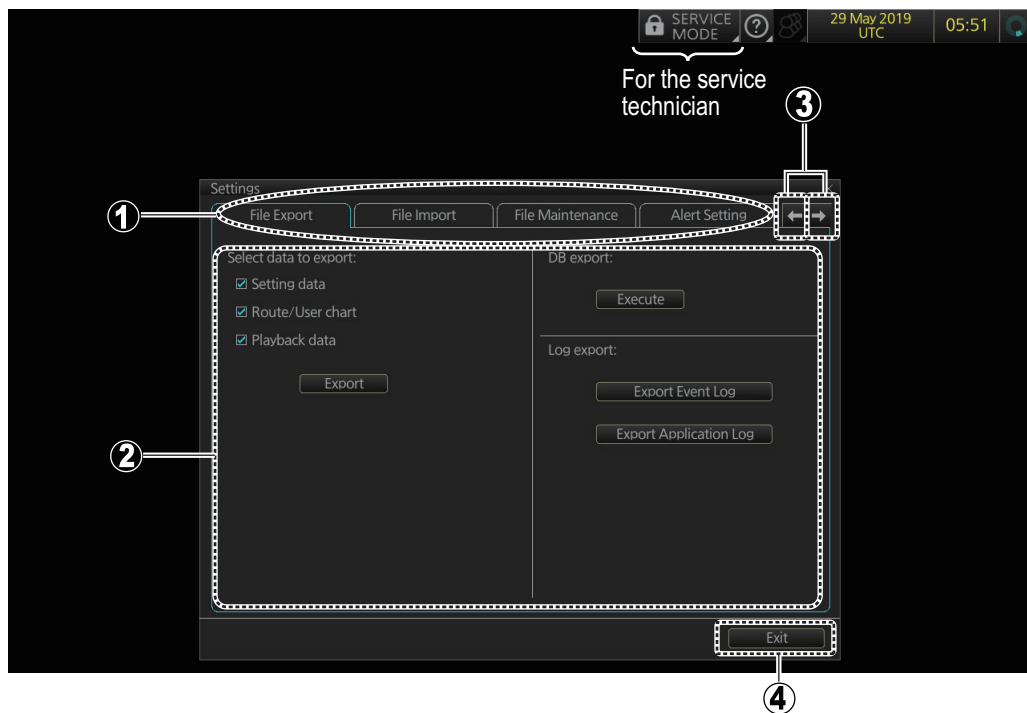

No.	Name	Description
1	Pages (menus)	A total of twelve menus. See the descriptions in this chapter.
2	Menu area	The menu for the selected page appears here.
3	Page selection buttons	Click to scroll the menus.
4	Exit button	Click to scroll the menus.

To open a page, use the page selection buttons to select a page then click the tab of the page required. The color of the border of the page selected is light blue.

22.2 File Export

The [File Export] page exports setting data, route/user charts, and playback data to a USB flash memory. Data is exported in .zip files

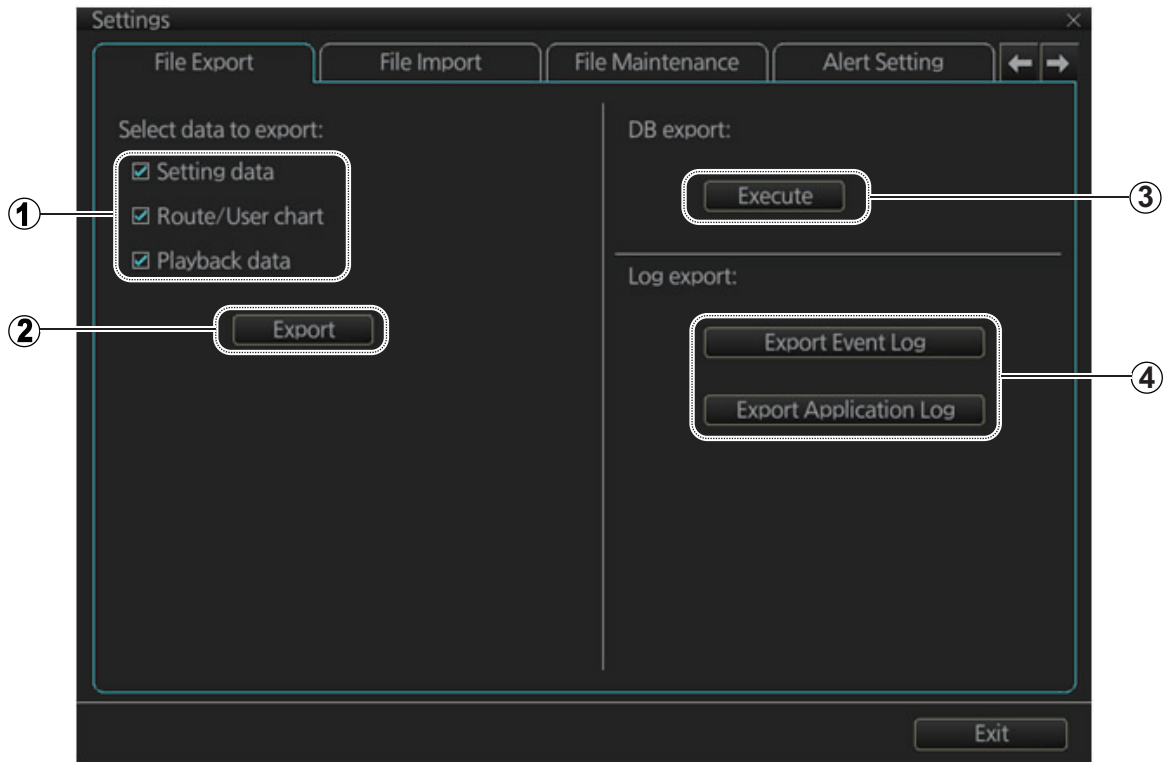

No.	Name	Description
1	Data selection	Check the data to export, setting data, route/user chart, and playback data. (The size of the log data is large, thus some time may be required to export the data.)
2	[Export] button	Click to export all items selected on this menu. The [SAVE FILE] dialog box appears. Select where to save the data, then click the [Save] button.
3	[Execute] button	Saves test data to the SSD, for use by service technicians. Only service technicians can extract the data.
4	[Export Event Log] button, [Export Application Log] button	Export the (encoded) event log and application log, respectively. The exported file can be sent to an agent or dealer to assist in troubleshooting.

Note 1: The [Export] button does not appear unless an item is checked.

Note 2: The message "Now processing" appears during the exporting, and "File export succeeded." appears upon completion. Click the [OK] button to finish.

22.3 File Import

The [File Import] page lets you import FMD-3xx0 series created setting data, routes/user charts and playback data from a USB flash memory.

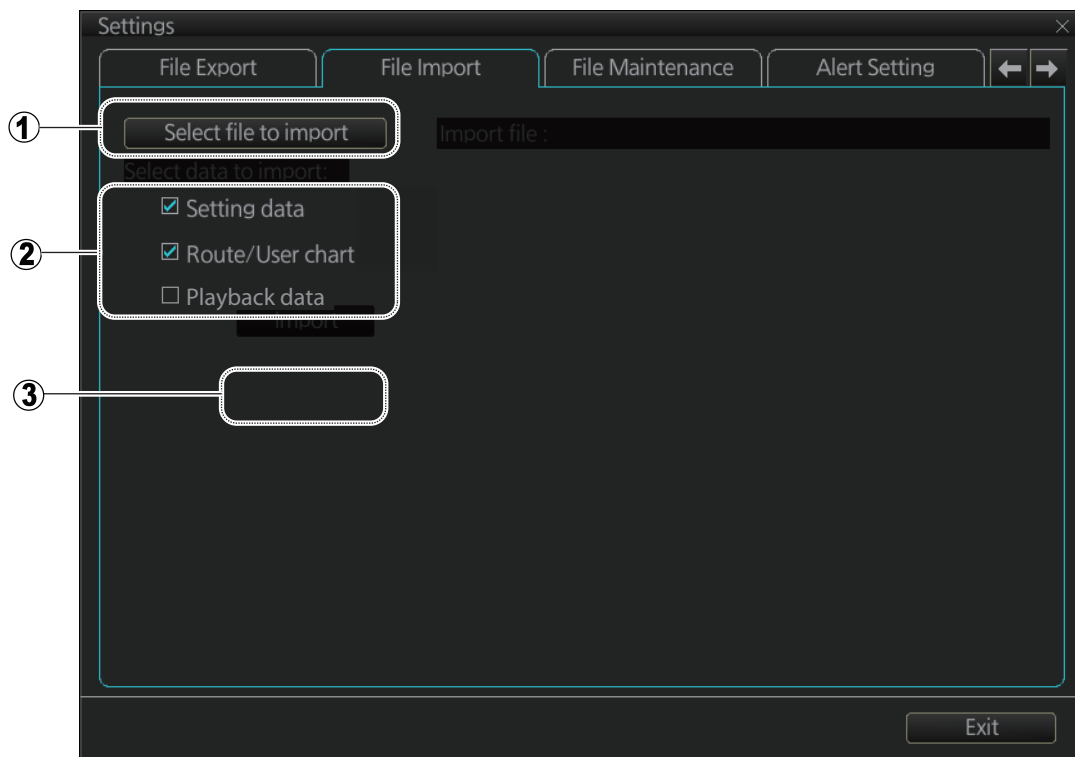

No.	Name	Description
1	Select file to import button	Click to show the [OPEN FILE] dialog box, where you can select the file to import.
2	Data selection	Check the data to import, setting data and route/user chart.
3	[Import] button	Click to import the objects selected. The message shown right appears. <div data-bbox="1018 1339 1417 1541" style="border: 1px solid black; padding: 5px; margin-top: 10px;"> <p>Attention</p> <p>Following data will be replaced with the imported data, and system will reboot automatically. Please export current data before import if needed.</p> <ul style="list-style-type: none"> - Setting data - Route/User chart <p>Do you wish to continue?</p> <p style="text-align: right;">No Yes</p> </div>

Note 1: Item 2 does not appear until after a file is selected. Item 3 appears after the data to import is selected.

Note 2: The message "Now processing" appears during the importing, and the message "File import finished." appears upon completion. Click the [OK] button.

Note 3: The size of the log data is large, thus some time may be required to import the data.

Note 4: The system automatically restarts after setting data is imported.

Note 5: If importing could not be completed, first check if the USB flash memory is properly inserted. If inserted properly, try importing again.

Note 6: Some setting data may be lost when importing that data from an FMD whose version is younger than 03.04. Confirm menu settings and re-set them as necessary.

22.4 File Maintenance

The [File Maintenance] page lets you restore the last-saved route/user chart application and Route/user chart system.

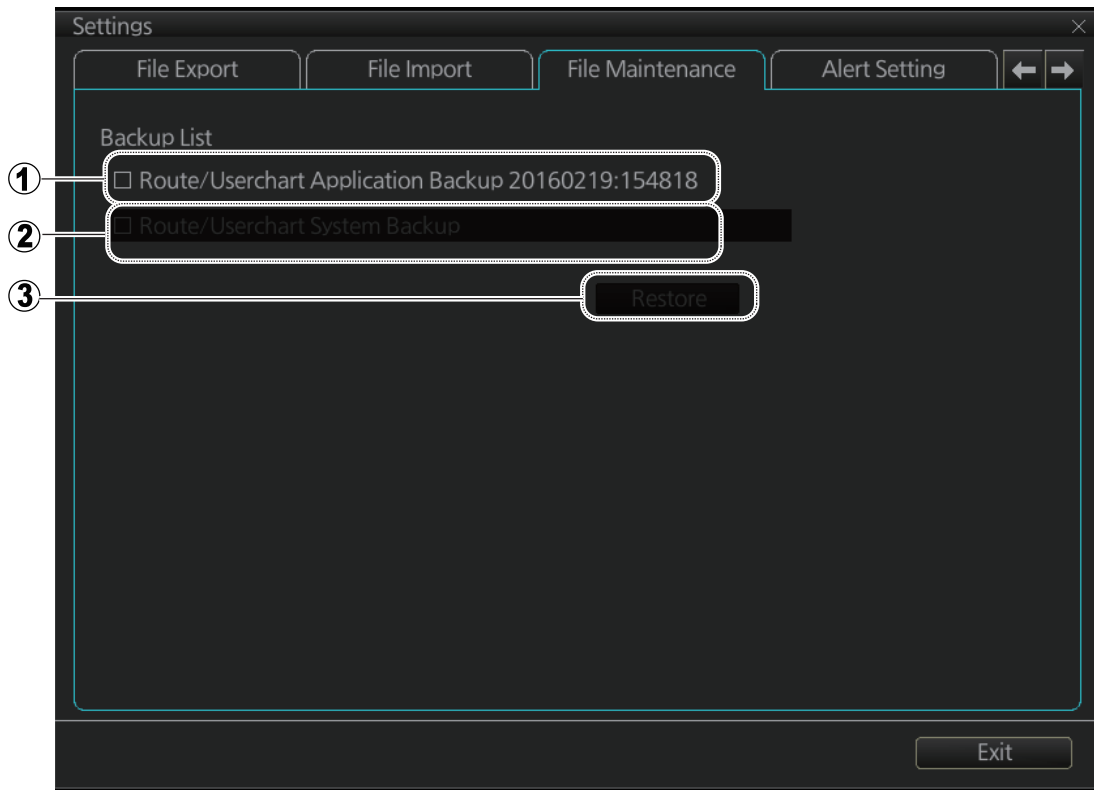

No.	Name	Description
1	Route/User chart Application backup	Check to restore last-saved route/user chart application.
2	Route/User chart System backup	Check to restore last-saved route/user chart system.
3	[Restore] button	Click to restore item selected.

Note: To restore the route data from the backup data, first check all route data then do the restore from the latest data.

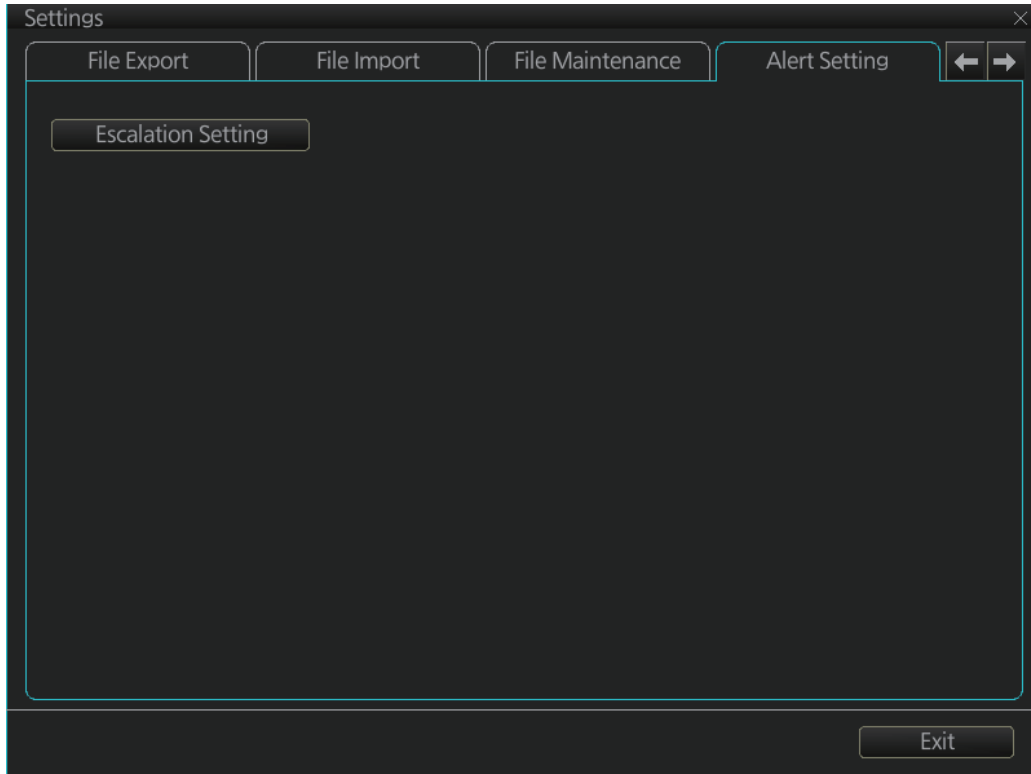

22.5 Alert Setting

The [Alert Setting] page sets how long to wait before the priority of an alert is raised to Warning or Alarm, when the alert goes unacknowledged. Click the [Escalation Setting] button to show the escalation settings. Alerts can be escalated to alarm level or repeated as a warning.

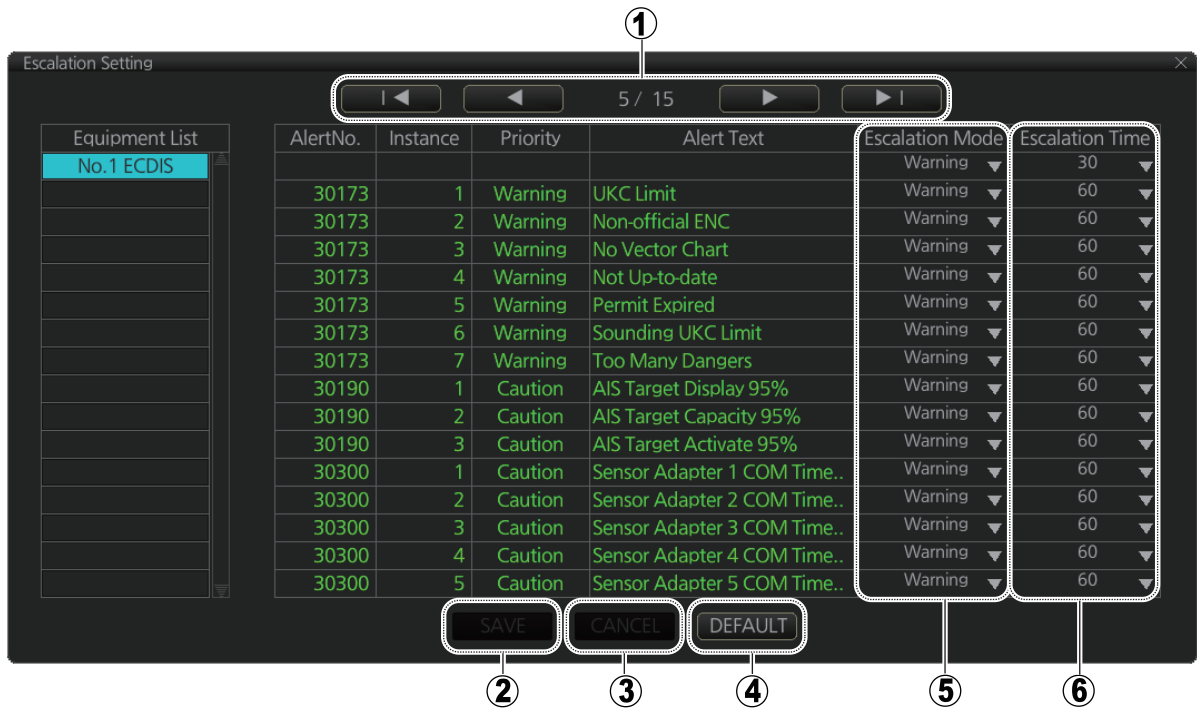

A grayed out [Escalation Mode] or [Escalation Time] value means that the value cannot be changed.

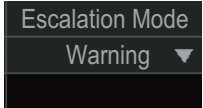

No.	Name	Description
1	Page selection buttons	Select alert page. ◀: Go to first page; ◀: Go to previous page ▶: Go to last page; ▶: Go to next page
2	[Save] button *1	Save settings.
3	[CANCEL] button *1	Cancel settings and restore all previous settings.
4	[DEFAULT] button	Restore factory settings.
5	Escalation Mode	<p>Set the escalation mode. [Warning]: Warning is repeated when the [Escalation Time] elapses. [Alarm]: The alert priority is changed if the alert is not acknowledged before the [Escalation Time] elapses. To globally assign escalation mode on the displayed page; change the setting below the item.</p> 
6	Escalation Time	<p>Escalation time is the number of seconds to wait before escalation occurs. The settings*2 are (in seconds) 30, 60, 90, 120, 150, 180, 210, 240, 270 and 300. To globally assign escalation time on the displayed page; change the setting below the item.</p>  <p>*2 The default value is 60 s, with the following exceptions:- “150 Early Course Change”: 30 s- “30802 Anchor Watch”: 120 s</p>

*1 These buttons appear when the setting of [Escalation Mode] or [Escalation Time] is changed.

22.6 Self Test

The [Self Test] page is used mainly to check the equipment. The equipment is inoperative during the test.

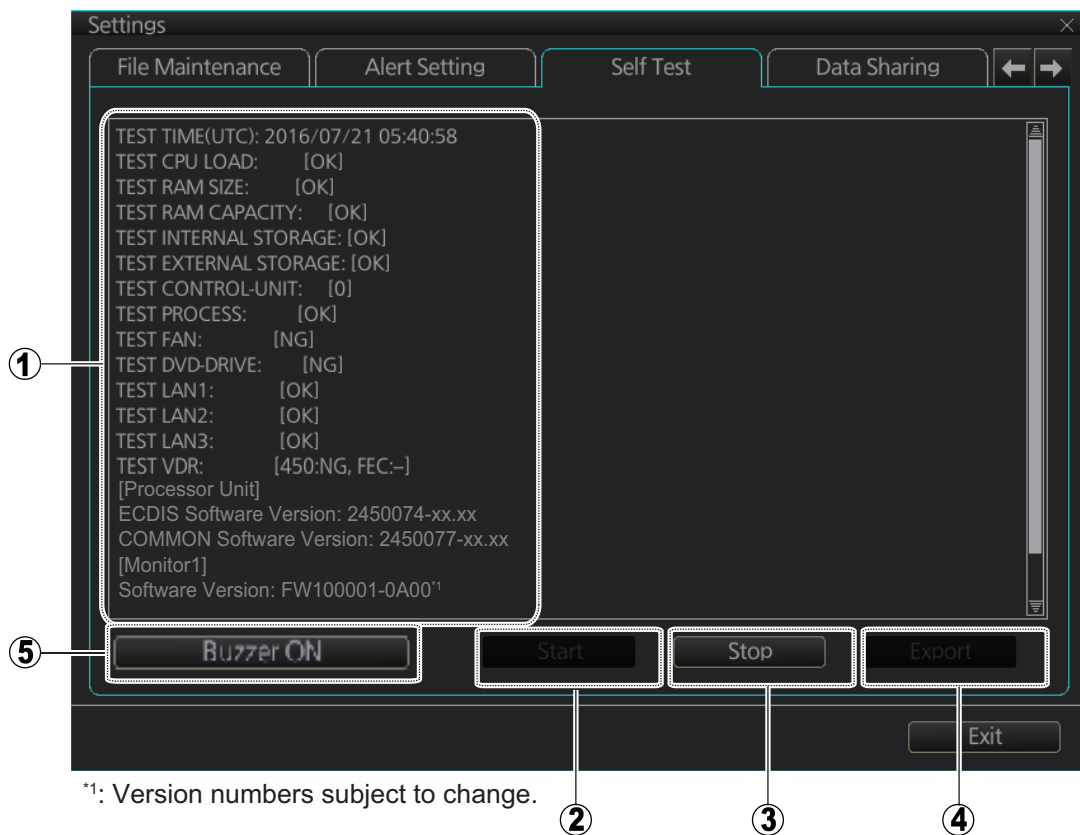

No.	Name	Description
1	Test results, program numbers, SSD info, IP conflict, dongle info	<ul style="list-style-type: none"> • Self test results • Program numbers for each software program • SSD's SMART information • IP conflict check result • Dongle information <p>Note: Program numbers and version numbers are subject to change.</p>
2	[Start] button	Start the self test.
3	[Stop] button	Stop the self test. (Shown during test.)
4	[Export] button	Export the results of the self test to an external medium (ex. USB flash memory).
5	[Buzzer ON] button	Test the buzzer.

22.7 Data Sharing

The [Data Sharing] page sets how to share data among units.

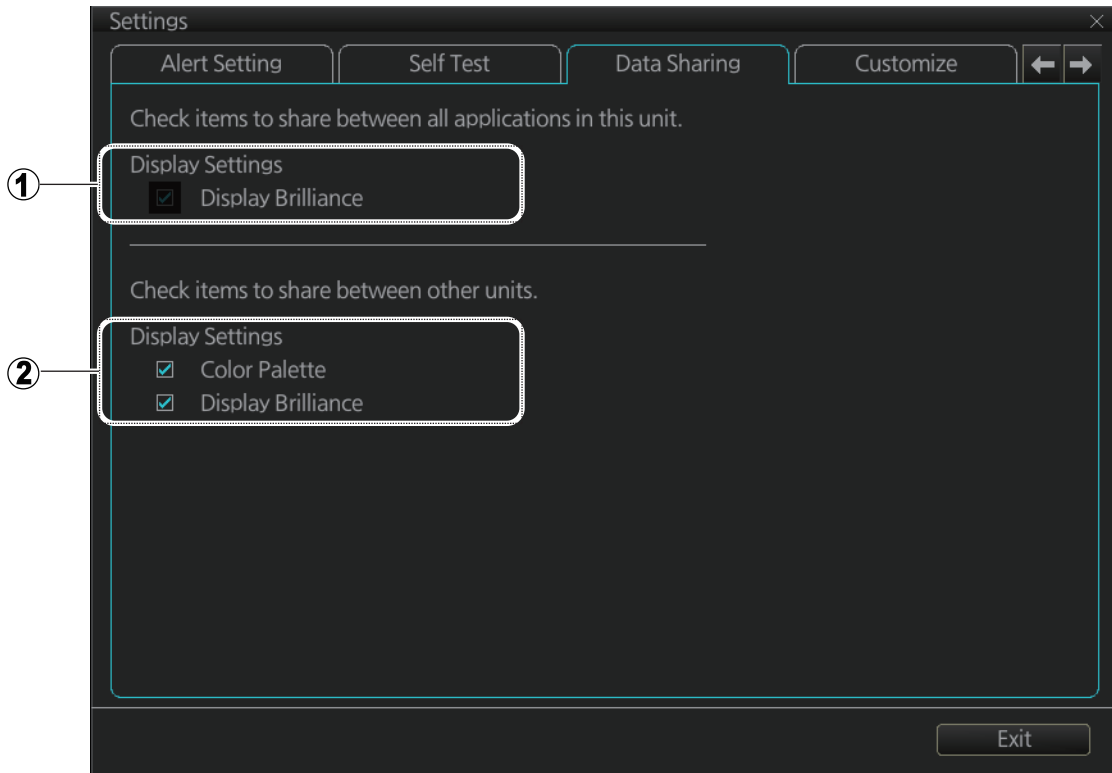

No.	Name	Description
1	Display Brilliance	Not used.
2	[Color Palette], [Display Brilliance]	<p>Set how to share color palette and display brilliance among the units (other FMD-3x00, FAR-3xx0) of the system. Check to share a setting among units, or uncheck to use local setting. After checking an item, a confirmation message appears. Click the [Yes] button to confirm selection. The chosen setting is reflected on the brilliance and color palette buttons on the Instant Access bar as follows:</p> <ul style="list-style-type: none"> • Item checked: “S” appears on the corresponding button to indicate the item is shared among the units of the system. • Item not checked: “L” appears on the corresponding button to indicate the item is not shared among the units of the system.

22.8 Customize

The [Customize] page lets you select scrollwheel rotation direction.

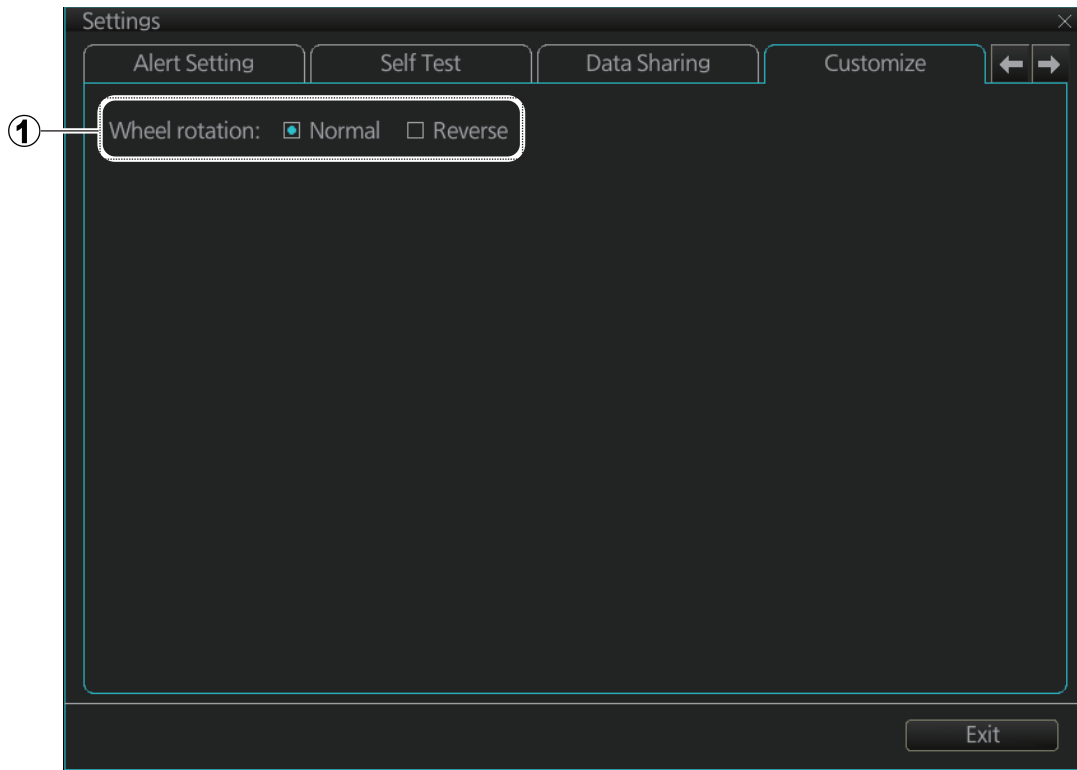

No.	Name	Description
1	Wheel rotation	Set the scroll direction. Normal: Downward to increase value, upward to decrease value. Reverse: Reverse of "Normal".

22.9 Display Test

The [Display Test] page displays various test patterns to check the PCU for proper display of colors. Click the [Display Test] button to start the test. The buzzer sounds at the start of the test.

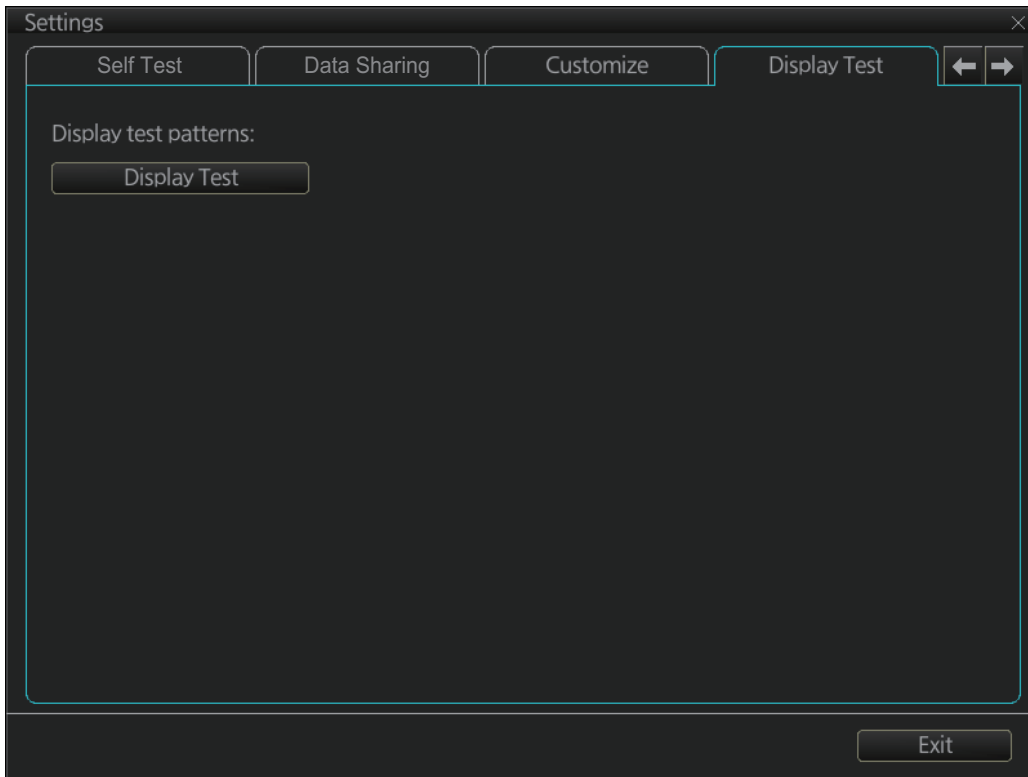

Left-click to proceed in the numerical order shown below; right click to proceed in reverse order.

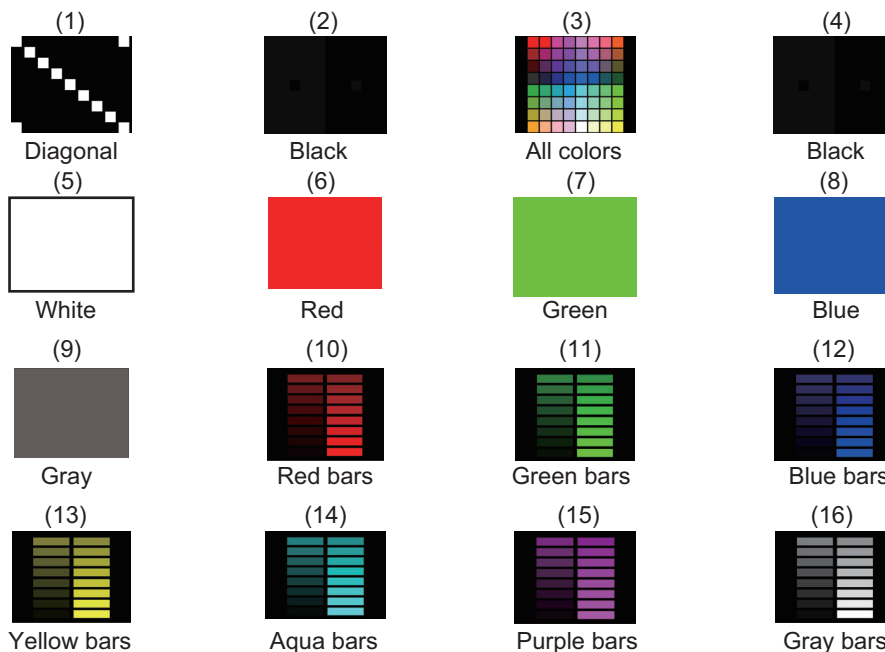

To quit the display test and close the [Settings] menu, click the [Exit] button. (The **Esc** key on the keyboard may also be used.)

22.10 Keyboard Test

The [Keyboard Test] page checks the controls on the Trackball Control Unit and the optional keyboard for proper operation.

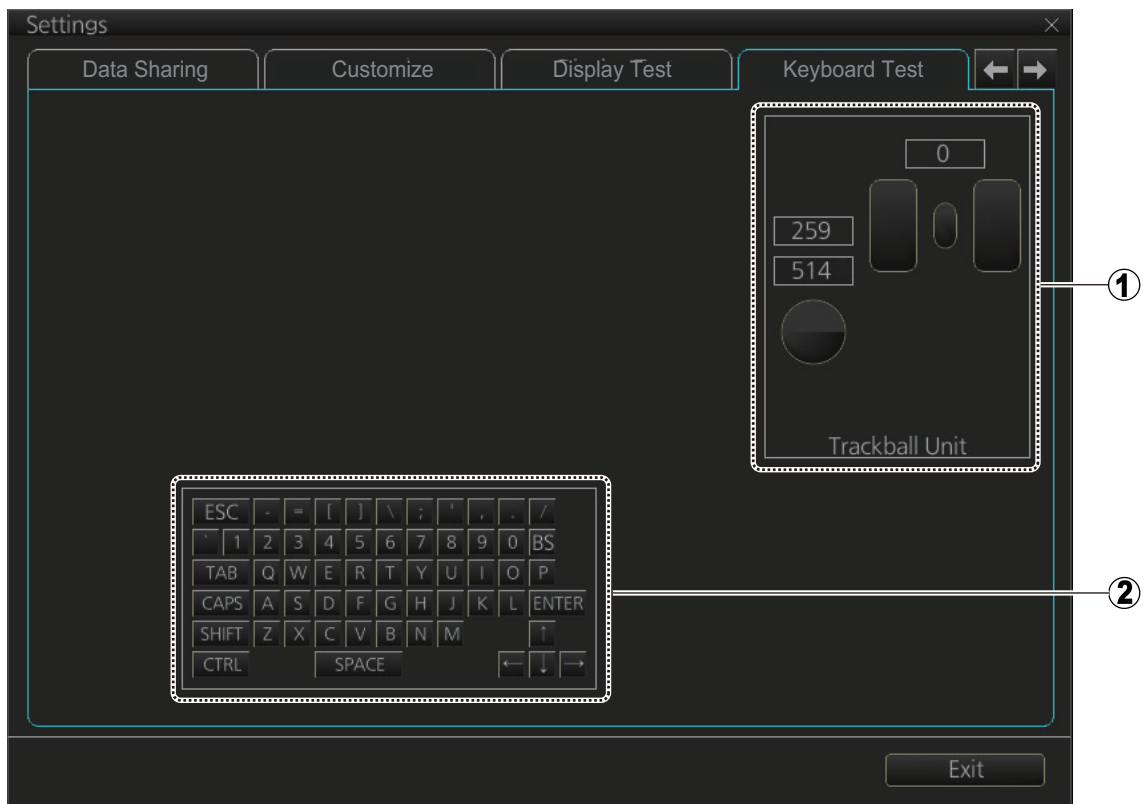

No.	Name	Description
1	Trackball Control Unit	<ol style="list-style-type: none"> 1) Spin the scrollwheel and rotate the trackball. The indication above the operated control shows the setting value. 2) Push each button. The window above a pushed button lights in light blue. 3) Push the scrollwheel. The window above the wheel lights in light blue.
2	Keyboard	Press a key. The corresponding location on screen lights in light blue if the key operation is normal.

22.11 Screenshots

The [Screenshot] page processes the screenshots saved to the HDD.



No.	Name	Description
1	List	List of screenshots taken. Screenshots are automatically assigned a file name consisting of the time and date the screenshot was taken.
2	Check boxes	Put a checkmark in the box of the screenshot to process.
3	Preview	Preview of the screenshot selected.
4	[Delete] button*	Delete the screenshot(s) selected.
5	[Export] button*	Export selected screenshot(s) to a USB flash memory.
6	[Print] button	Prints the selected screenshot.
7	[Apply] button*	Save comment.
8	Comment box	Enter comment for screenshot. Put a check in appropriate checkbox then enter comment.

* Button does not appear until related action is completed.

22.11.1 How to export screenshots

You can export screenshots to a USB flash memory as follows:

1. Insert a USB flash memory in a USB port on the PCU.
2. Open the [Screenshot] page.
3. Put a checkmark in the checkbox of the screenshot(s) to export.
4. Click the [Export] button.

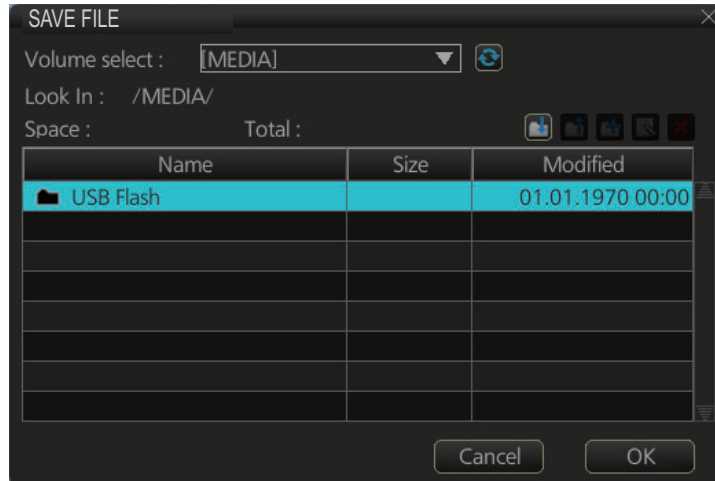

5. Select the USB flash memory.
6. Click the [OK] button to export the screenshots selected.

22.11.2 How to delete screenshots from the PCU

1. Select the [Screenshot] page.
2. Put a checkmark in the checkbox of the screenshot(s) to delete. To select all screenshots, right-click the box to the left of the [Date] column then select [Select all]. To clear all check marks, select [Clear all].
3. Click the [Delete] button. You are asked "Selected files will be deleted. Do you wish to continue?"
4. Click the [Yes] button to delete the screenshots selected.

22.11.3 How to print screenshots

With connection of a printer you can print the screenshots stored in the SSD of the processor unit.

1. Select the [Screenshot] page.
2. Select the screenshot to print. Note that multiple screenshots cannot be printed at the same time.
3. Click the [Print] button.
4. Click the [OK] button to finish.

22.12 User Default

The [User Default] page restores all default settings for the [Chart Display] and [Symbol Display]. Click the [Restore User Setting] button. The power is reset after the default settings are restored.

If you require the settings shown below, copy them to a USB flash memory (using the file export feature), BEFORE restoring user defaults.

- Setting data
- Route/User chart

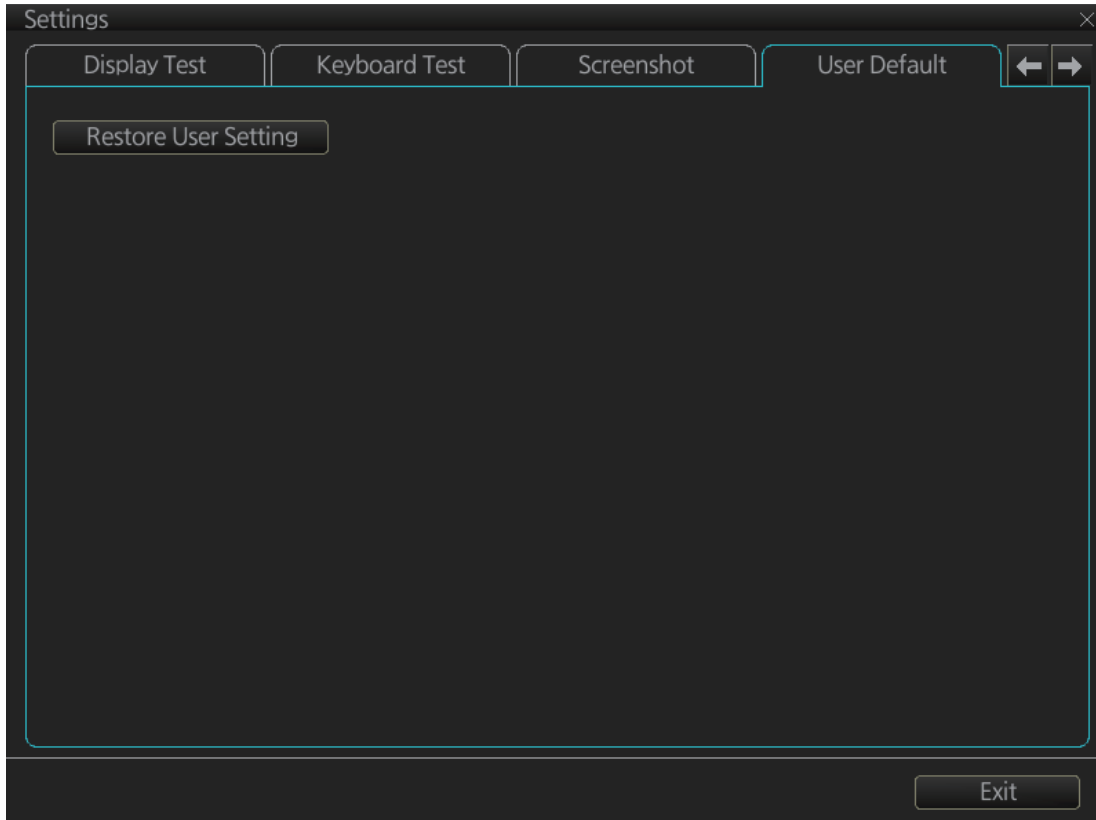

22.13 CCRP

The [CCRP] page provides for selection of CCRP (Consistent Common Reference Point) and shows the location of various sensors.

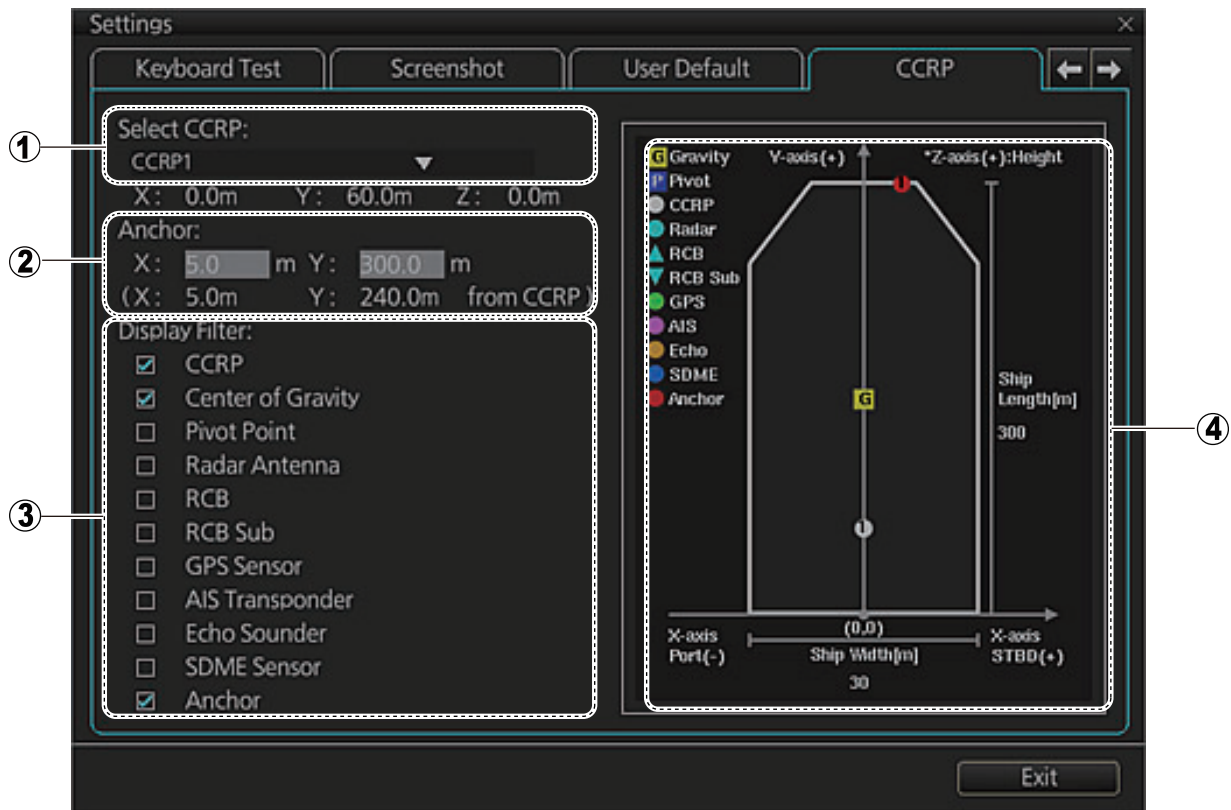



No.	Name	Description
1	CCRP	Select the CCRP to use in the case of multiple CCRPs.
2	Anchor	Enter anchor installation position (X and Y values from CCRP). The setting ranges are X, -15.0 to 15 m; Y, 0.0 to 300.0 m.
3	Display Filter	Check the items to show on the ship's graphic.
4	Ship's graphic	Shows the location of the sensors selected at the [Display Filter].

This page is intentionally left blank.

23. MAINTENANCE AND TROUBLESHOOTING

Periodic checks and maintenance are important for proper operation of any electronic system. This chapter contains maintenance and troubleshooting instructions to keep optimum performance and the longest possible life of the equipment. Before attempting any maintenance or troubleshooting procedure please review the safety information below. If you cannot restore normal operation after following the troubleshooting procedures, do not attempt to check inside any unit; there are no operator-serviceable parts inside. Refer any repair work to a qualified technician.

 WARNING	NOTICE
 <p>ELECTRICAL SHOCK HAZARD Do not open the equipment.</p> <p>Only qualified personnel can work inside the equipment.</p>	<p>Do not apply paint, anti-corrosive sealant or contact spray to coating or plastic parts.</p> <p>Those items contain organic solvents that can damage coating and plastic parts, especially plastic connectors.</p>

23.1 Maintenance

Regular maintenance is essential to good performance. A regular maintenance program should be established and should at least include the items shown in the table below.

Interval	Check point	Check and measures	Remarks
When needed	LCD	To clean the LCD, wipe the LCD carefully to prevent scratching, using tissue paper and an LCD cleaner. To remove dirt or salt deposits, use an LCD cleaner, wiping slowly with tissue paper so as to dissolve the dirt or salt. Change paper frequently so the salt or dirt will not scratch the LCD. Do not use solvents such as thinner, acetone or benzene for cleaning. Also, do not use a degreaser or an antifog solution, as they can strip the coating from the LCD.	Do not use chemical-based cleaners for cleaning. They can remove paint and markings.
3 to 6 months	Cabling	Check that all cabling is firmly connected and is not damaged.	Replaced damaged cabling.

23.2 Trackball Maintenance

If the cursor moves abnormally, clean the trackball and inside the trackball housing (including the lens) as shown below:

1. Turn the retaining ring on the trackball module in the direction of the arrows (see figure below) to unlock it, then remove the retaining ring.

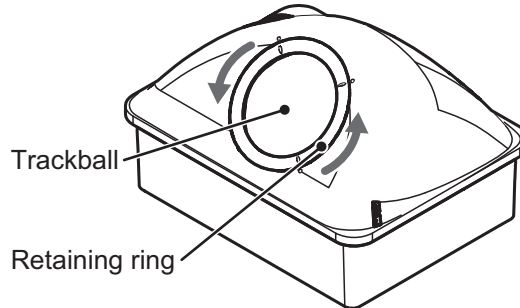

2. Use cellophane tape to remove the trackball from the trackball housing. Place the trackball and the retaining ring on a clean, soft cloth laid on a flat surface.
3. Clean the ball with a damp, soft cloth, then use a dry, lint-free cloth to carefully wipe the ball dry.
4. Use a swab, moistened with water, to carefully clean the inside of the retaining ring, the inside of the trackball housing, the supports and the lens. Change the swab regularly so that dirt and dust build-up is easily removed. Use a dry swab to wipe away moisture.

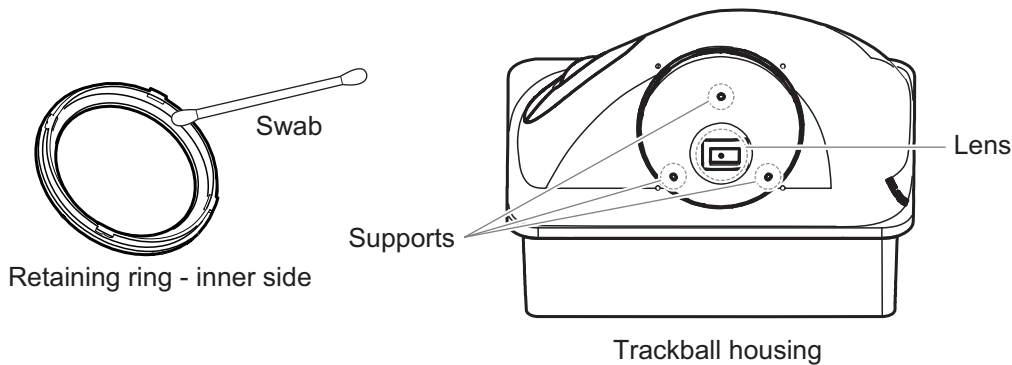

5. Re-set the ball and retaining ring. Be sure the retaining ring is not inserted reversely.

23.3 Troubleshooting

The troubleshooting table below provides common faults and the remedies with which to restore normal operation.

Troubleshooting

If...	then...	Remedy
power cannot be turned on	<ul style="list-style-type: none"> power connector may have loosened. power supply is off. 	<ul style="list-style-type: none"> Check connector. Check power supply.
power can be turned on but nothing appears on the display	<ul style="list-style-type: none"> brilliance is too low. 	<ul style="list-style-type: none"> Adjust brilliance.
the picture freezes (display is not updated)	<ul style="list-style-type: none"> ECDIS internal error. 	<ul style="list-style-type: none"> Press the power switch until the power goes off. Turn on the power again to restore normal operation.
<ul style="list-style-type: none"> the buzzer is sounding continuously and the working indicator has stopped the buzzer is sounding continuously and the screen is blacked out 	<ul style="list-style-type: none"> suspect system error 	<ul style="list-style-type: none"> Press and hold down the power switch until the power goes off. Then turn on the power again to restore normal operation.
message "There is no dongle or an error has occurred in the dongle. The system will automatically shut down." appears	<ul style="list-style-type: none"> dongle is not connected. data in the dongle is corrupted. 	<ul style="list-style-type: none"> Connect dongle. Contact FURUNO for assistance.
monitored route is not displayed	<ul style="list-style-type: none"> route has not been selected. monitor route has not been selected to be visible above the chart. 	<ul style="list-style-type: none"> Select route to monitor. Open the [Route] page of the [Symbol Display] menu and check the monitored route parts to show.
planned route is not displayed	<ul style="list-style-type: none"> route has not been selected. planned route has not been selected to be visible above the chart. 	<ul style="list-style-type: none"> Select route as "planned". Open [Route] page of [Symbol Display] menu and check the planned route parts to show.
symbol of user chart cannot be erased	<ul style="list-style-type: none"> two or more symbols may be superimposed on each other. 	<ul style="list-style-type: none"> Do the delete action several times.
route monitored is stopped	<ul style="list-style-type: none"> Alert 691: RM Stop - Exceed Max XTE. Own ship is too far away from the route. Alert 692: No Valid Sensor Data. ECDIS internal error. Alert 693: RM Stop - Other Causes. Required data (position, SOG/COG) not found. 	<ul style="list-style-type: none"> Steer the ship back to the route then restart route monitoring. Request service. Check sensor connections.
position cannot be found	<ul style="list-style-type: none"> position sensor(s) is not selected on the [POSN] page. position sensor is turned off. sensor cable has loosened. 	<ul style="list-style-type: none"> Check position sensor selections. Turn on position sensor. Check cable.

If...	then...	Remedy
ARCS chart cannot be displayed	<ul style="list-style-type: none"> no ARCS chart for area. dongle is not connected. license has expired. 	<ul style="list-style-type: none"> Open ARCS chart from the [Manage Charts] dialog box. Connect dongle. Renew ARCS license.
S57 chart cannot be displayed	<ul style="list-style-type: none"> no ENC chart for area. dongle is not connected. 	<ul style="list-style-type: none"> Open S57 chart from [Manage Charts] dialog box. Connect dongle.
past track is not displayed	<ul style="list-style-type: none"> past track is not selected to be visible. 	<ul style="list-style-type: none"> Open [Tracking] page of [Symbol Display] menu and select [Own Ship Past Tracks] to [CCRP], [Primary], [Secondary] or [Pivot] as appropriate.
monitored user chart is not displayed on ECDIS display	<ul style="list-style-type: none"> user chart is not selected to be visible. 	<ul style="list-style-type: none"> Open [Mariner] page of [Symbol Display] menu and select parts to show.
user chart is not displayed on radar overlay	<ul style="list-style-type: none"> user chart is not selected in Voyage navigation mode. 	<ul style="list-style-type: none"> Select user chart in Voyage navigation mode.
the message "Nearing memory usage limit. Click the Restart button to restart the system to prevent trouble." appears	<ul style="list-style-type: none"> the memory usage limit for software is close to capacity. Performance may be affected. 	<ul style="list-style-type: none"> If you need to save your work, click the [Later] button then reset the power. If you don't need to save your work, click the [Restart] button.
message "Nearing memory usage limit. If you will start monitoring, click the Restart button to restart the system to prevent trouble during route monitoring."	<ul style="list-style-type: none"> the memory usage limit for software is close to capacity. Performance may be affected. 	<ul style="list-style-type: none"> Click the [Restart] button.
the message "Memory usage limit reached. Click the Restart button to restart the system to prevent trouble." appears.	<ul style="list-style-type: none"> the memory usage limit for software is reached. Performance may be affected. 	<ul style="list-style-type: none"> Reset the power. No other operations are available other than restart.

23.4 Consumable Parts

The table below lists the consumable parts in the Sensor Adapter MC-3000S. Replace the parts before their expected expirations.

Unit	Part	Type	Life
Sensor Adapter MC-3000S	MC-CS Board	24P0114	8.5 years

23.5 Color Differentiation Test for S57 Charts

The color differentiation checks if the monitor can distinguish between the various color-coded areas, lines and symbols.

1. Click the [Chart INFO] and [Chart 1] buttons on the InstantAccess bar to show the [ECDIS Chart 1] menu.

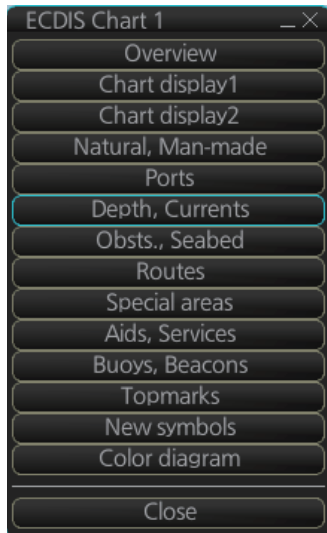

2. Click [Color diagram] to show the color test diagram.

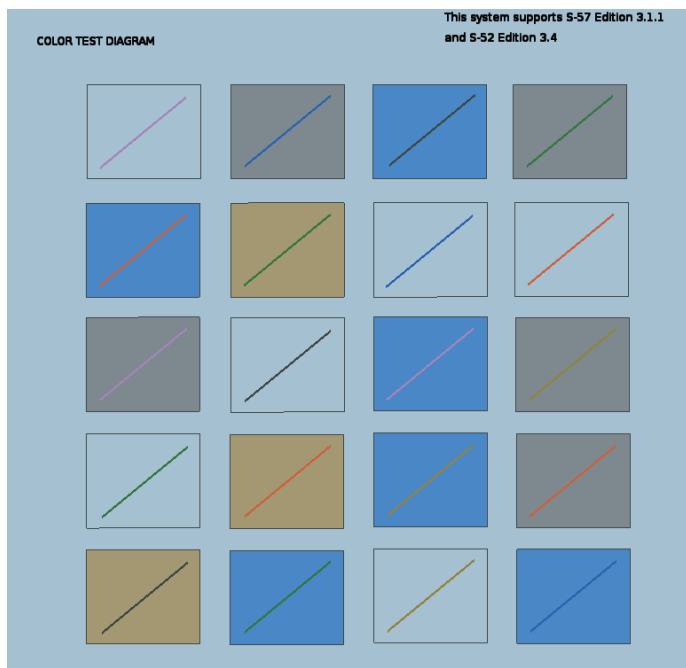

If the colors are correct, the diagonal line will be distinguishable from its surroundings, at any brilliance setting.

This page is intentionally left blank.

APPX. 1 MENU TREE

Main Menu

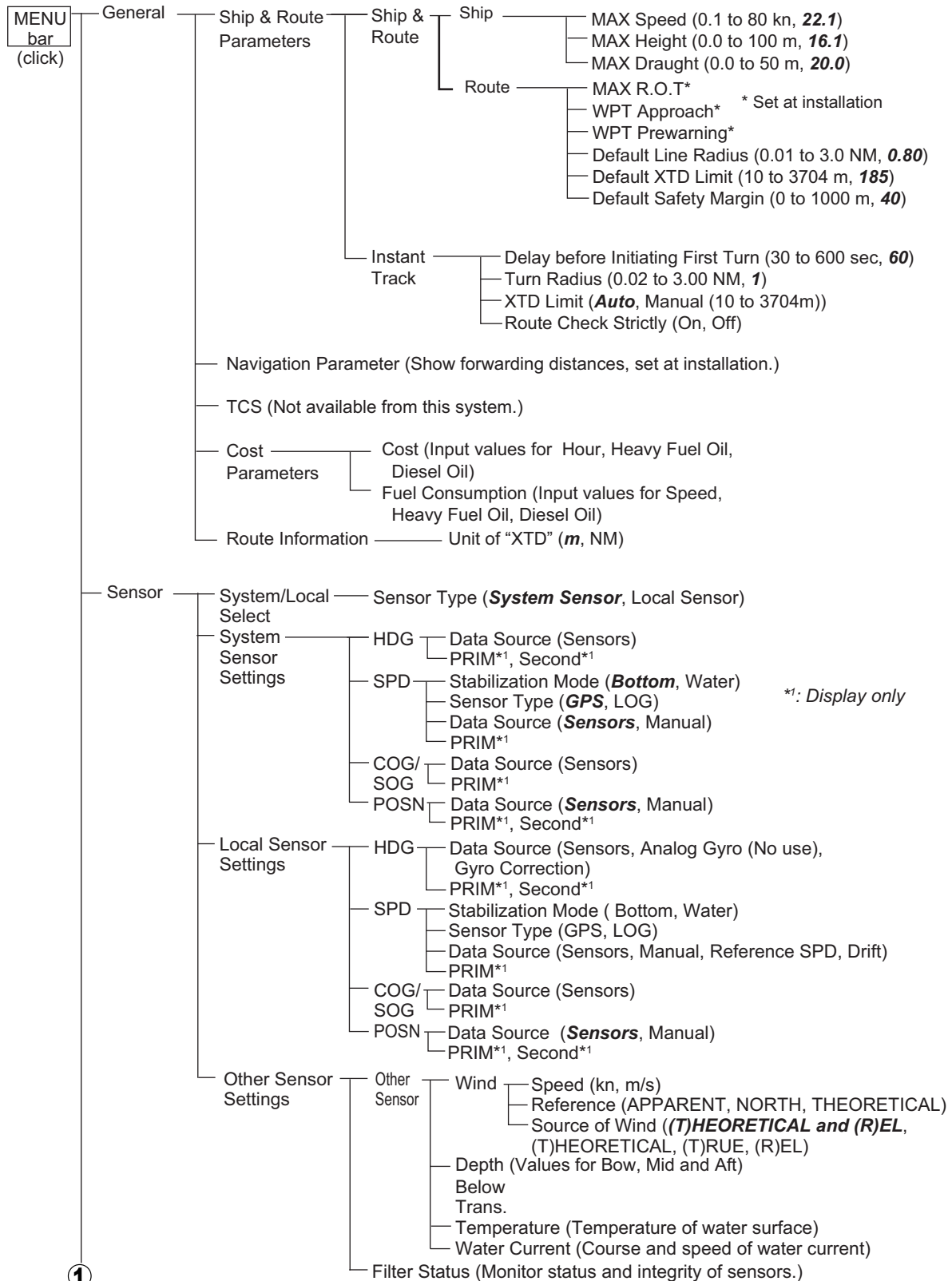

①

(Con't on next page)

APPX. 1 MENU TREE

① (Con't from previous page)

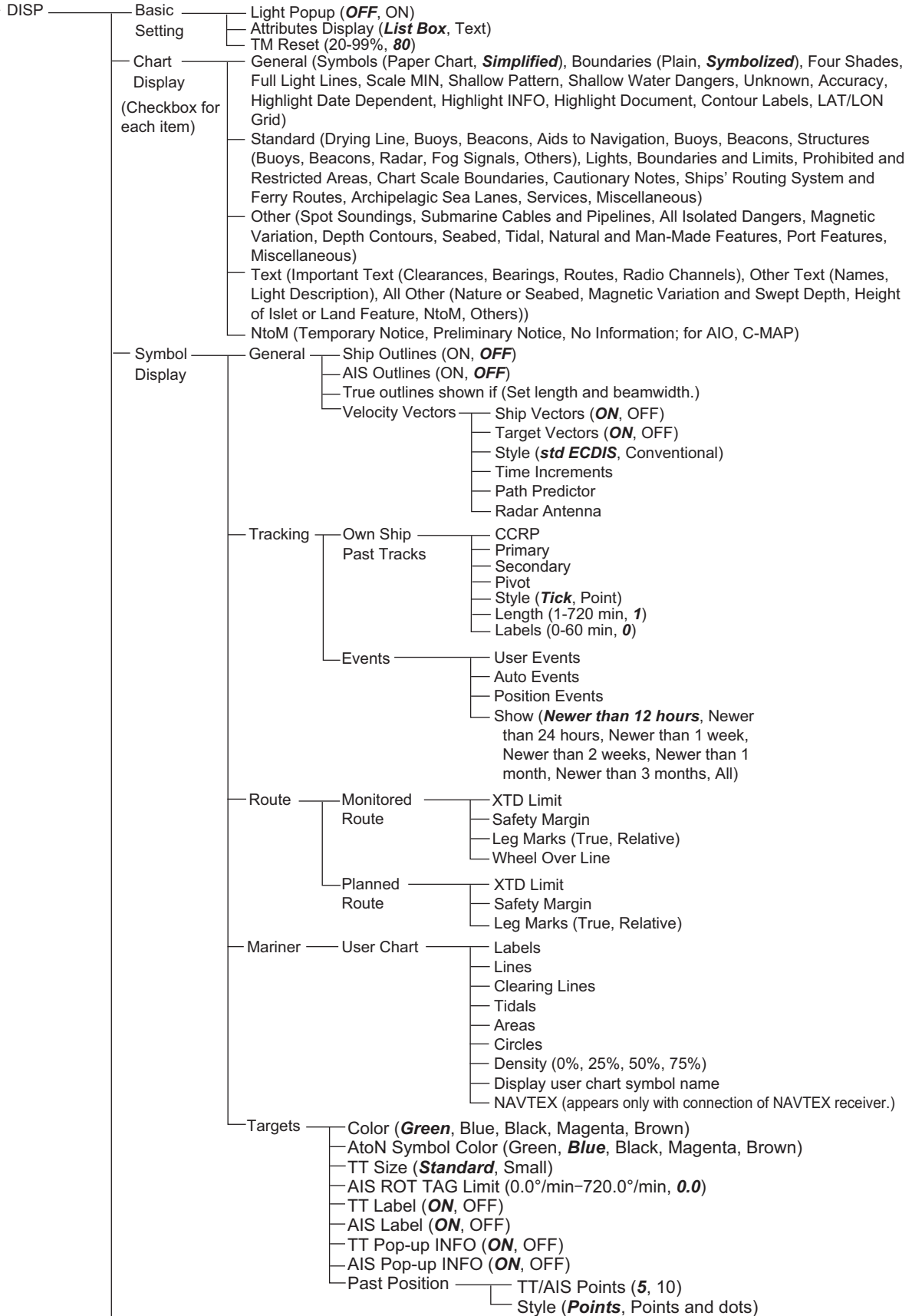

①

② (Con't on next page)

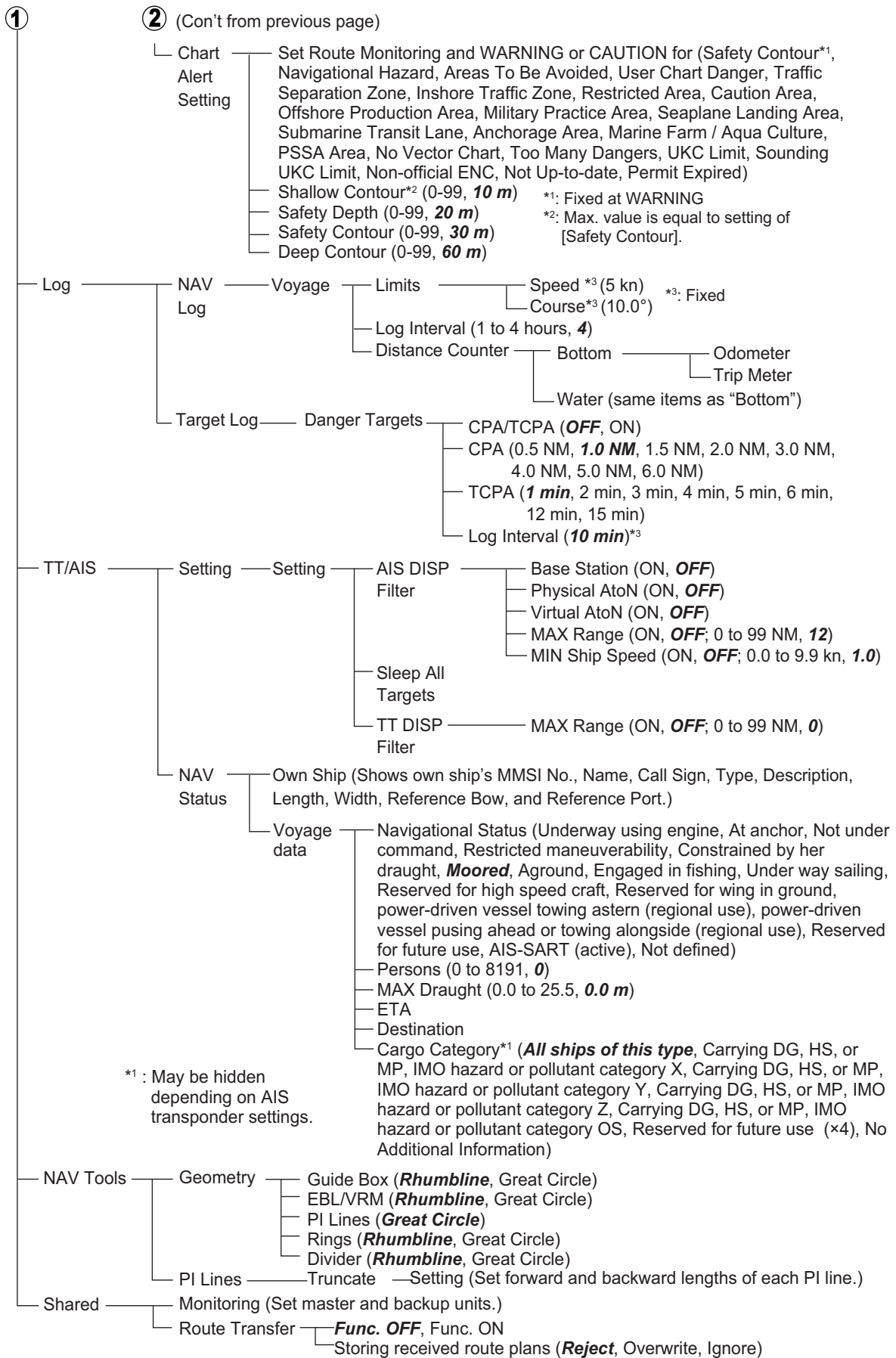

Settings Menu

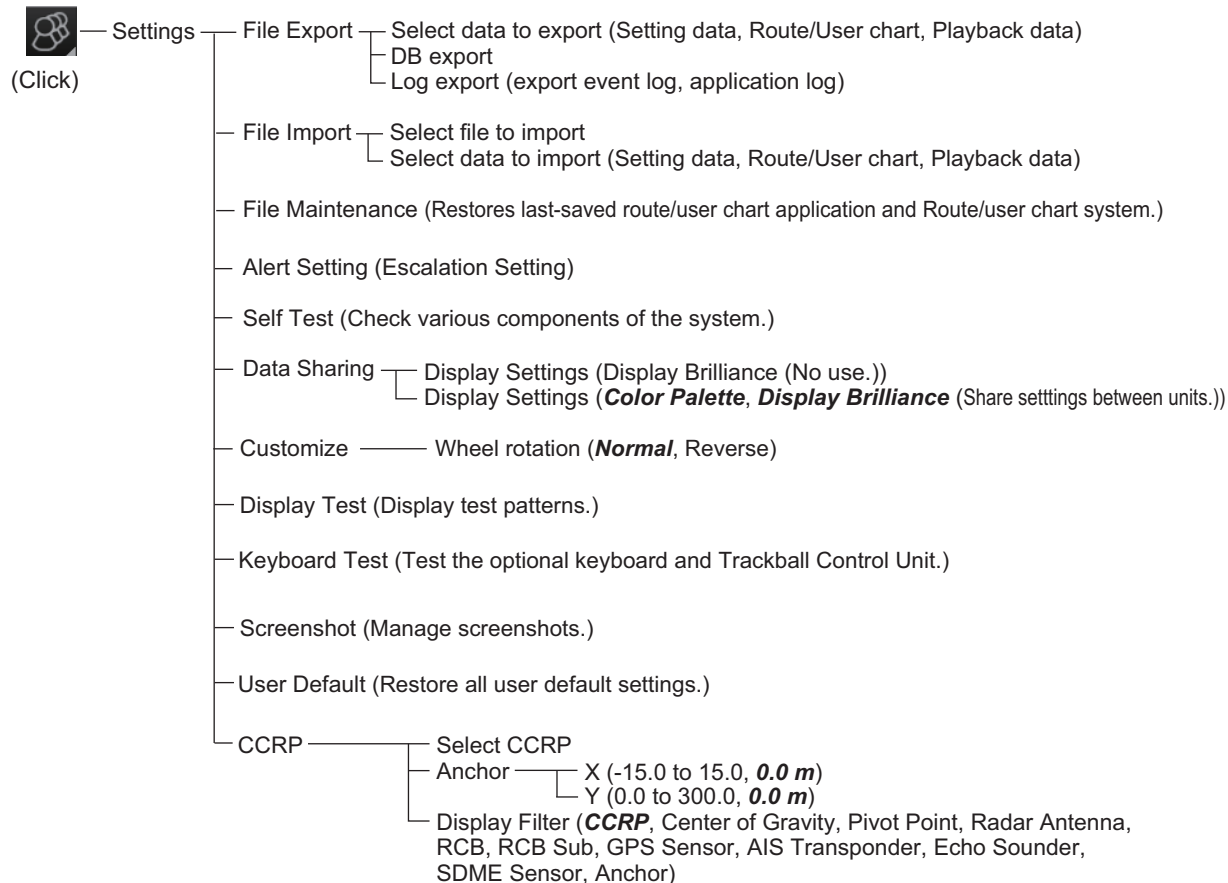

APPX. 2 ABBREVIATIONS,SYMBOLS

Abbreviations

Abbreviation	Meaning
ACK	Acknowledge
ACQ	Acquire
ACT	Activate
ADJ	Adjustment
AIO	Admiralty Information Overlay
AIS	Automatic Identification System
ANT	Antenna
Apr	April
ATON	Aid To Navigation
Aug	August
AUTO	Automatic
BB	Blackbox
BCR	Bow Cross Range
BCT	Bow Cross Time
BLU	Blue
BNWAS	Bridge Navigational Watch Alarm System
BRG	Bearing
BT	Bottom Tracking
Caps	Capital (letters)
CAT	Category
CCRP	Common Consistent Reference Point
CH	Channel
COG	Course over the Ground
COM	Communication
CONFIG	Configuration
CORRE	Correlation
CPA	Closest Point of Approach
CPU	Central Processing Unit
CSE	Course
CU/TM	Course-up/True Motion
CYA	CYAN
Dec	December
DEMO	Demonstration
DISP	Display
DR	Dead Reckoning
E	English
E	East
EBL	Electronic Bearing Line
EPFS	Electronic Position Fixing System
ETA	Estimated Time of Arrival
EXT	External
Feb	February
FILT	Filter





APPX. 2 ABBREVIATIONS,SYMBOLS



Abbreviation	Meaning
GPS	Global Positioning System
GRN	Green
GRY	Gray
Gyro	Gyrocompass
HDG	Heading
hr	hour
IHO	International Hydrographic Organization
IMO	International Maritime Organization
IND	Indication
INS	Integrated Navigation System
J	Japanese
Jan	January
Jul	July
Jun	June
kyd	kiloyard
L	Long (pulse length), or Local
L/L	Latitude/Longitude
LAN	Local Area Network
LL	Latitude, Longitude
LO	Low
MAG	Magnetic or Magenta
MAN	Manual
Mar	March
MAX	Maximum
MID	Middle
min	minute
MIN	Minimum
MMSI	Maritime Mobile Service Identity
MOB	Man Overboard
MON	Monitor
MSG	Message
N	North
NAV	Navigation, Navigator
Navtex	Navigational Telex
NM	Nautical miles
NO.	Number
Nov	November
NtoM	Notice to Mariners
Oct	October
OP	Operation
OS	Own Ship
PC	Personal Computer
PERPENDIC	Perpendicular
PI	Parallel Index (lines)
POSN	Position
PRIM	Primary
PSSA	Particularly Sensitive Sea Area
R	Relative
REF	Reference



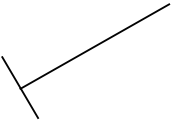

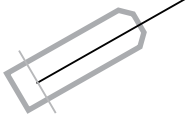
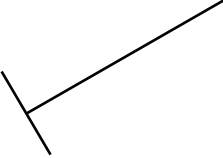
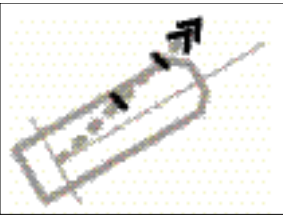
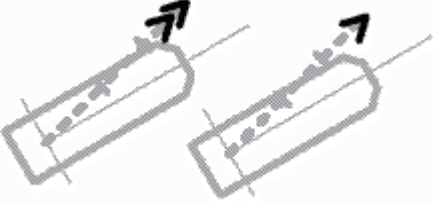

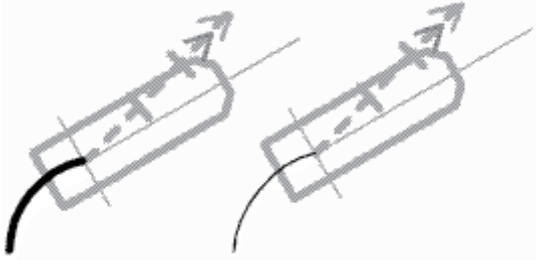
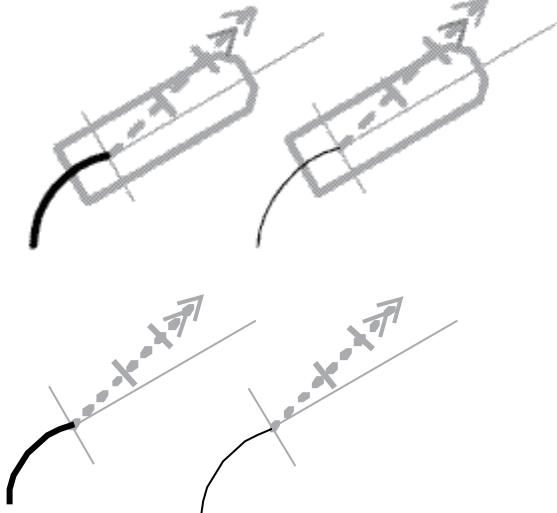
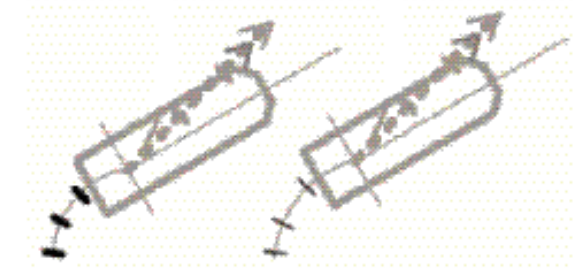
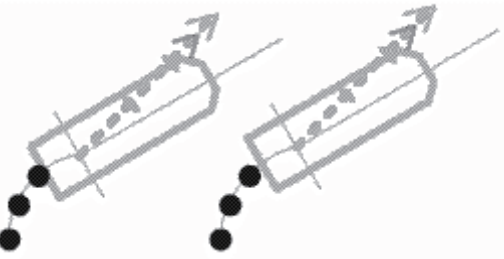
Abbreviation	Meaning
Rel	Relative
RM	Relative Motion
RNG	Range
ROT	Rate of Turn
S	South, or System
s	Second
S1 (2)	Short1(2) (pulse length)
SAR	Search And Rescue
SART	Search And Rescue Transponder
SDME	Speed and Distance Measuring Equipment
SEL	Select
Sep	September
SM	Statute Miles
SOG	Speed Over the Ground
SPD	Speed
SPEC	Specification
SSD	Solid State Drive, Solid State Device
S.SRC	Sensor Source
STAB	Stabilization
STBY	Stand-by
STD	Standard
SW	Switch
SYNC	Synchronization
T	True
TB	True Bearing
TC	Track Control
TCPA	Time to Closest Point of Approach
TCS	Track Control System
TGT, TGTS	Target, Targets
TM	True Motion
T.GND	True-ground
T.WAT	True-sea
TT	Tracked Target or Target Tracking
TTD	Tracked Target Data
TTG	Time to go
TTM	Tracked Target Information
TX	Transmit
UKC	Under Keel Clearance
UTC	Universal Time, Coordinated
VECT	Vector
VRM	Variable Range Marker
W	West
W/O	Without
WHT	White
WOL	Wheel Over Line
WOP	Wheel Over Point
WPT	Waypoint
WT	Water Tracking
XTD	Cross Track Distance





Abbreviation	Meaning
YEL	Yellow

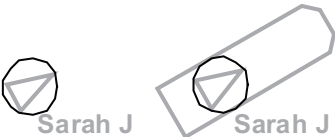



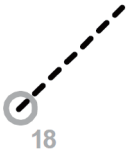
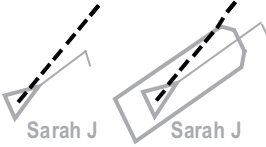
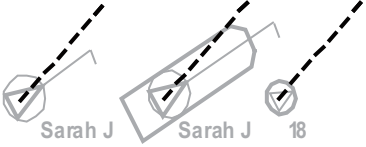
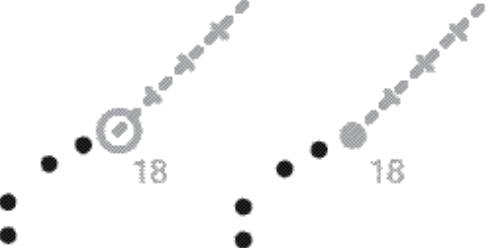
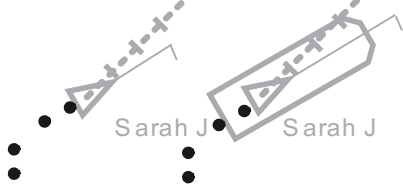
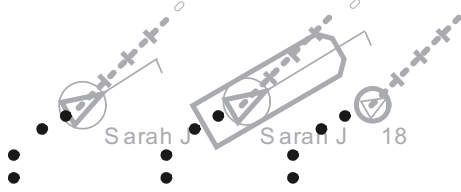

ECDIS Symbols

Symbol name and description	Symbol graphic(s)
<p>Own ship - true scaled outline This can be displayed when based on user selection either beam width or length is more than 3 mm.</p>	
<p>Own ship - simplified symbol</p>	
<p>Own ship - minimized symbol</p>	
<p>Radar antenna position This symbol indicates location of the radar antenna. Select if position of radar antenna is displayed with symbol X by Symbol Display menu.</p>	
<p>Own ship heading line This line originates from CCRP or Radar antenna position. CCRP: Consistent Common Reference Point</p>	
<p>Beam line This line passes through the CCRP or radar antenna position.</p>	
<p>Velocity vector - time increments</p>	
<p>Velocity vector - stabilization indicator Ground stabilization is indicated by double arrowhead and water stabilization is indicated as single arrowhead.</p>	



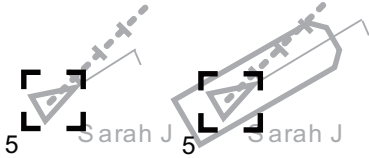
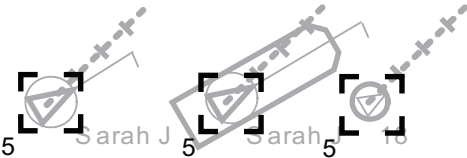

Symbol name and description	Symbol graphic(s)
<p>Past track System past track is indicated by thick line. Raw sensor primary past track is indicated by thin line. Raw sensor secondary past track is indicated by gray thin line.</p>	
<p>Past track - time increments Time increments are presented as single lines perpendicular to the past track.</p>	
<p>Past track - past positions Past positions are drawn as bold lines.</p>	
<p>Past track - past positions Past positions are drawn as small filled circular symbols.</p>	
<p>Radar targets in acquisition state</p>	 <p>5 mm in diameter</p>
<p>Tracked radar targets TT: Std or small user selection by Symbol Display</p>	 <p>3 mm in diameter</p>

Symbol name and description	Symbol graphic(s)
<p>Tracked radar targets - alternative TT: Std or small user selection by Symbol Display</p>	 1 mm in diameter
<p>Sleeping AIS targets Orientation is towards heading (or COG if heading unknown). If both heading and COG are unknown the orientation is toward top of display.</p>	 Sleeping AIS target Sleeping AIS target with no CPA/TCPA data
<p>Activated AIS targets Orientation is towards heading (or COG if heading unknown). If both heading and COG are unknown the orientation is toward top of display.</p>	 Activated AIS target Activated AIS target with no CPA/TCPA data
<p>Activated AIS targets - true scaled outline</p> <ul style="list-style-type: none"> This can be displayed when based on user selection either beam width or length is more than 3 mm. AIS outline: ON/OFF 	
<p>Activated AIS targets - associated target</p>	<p>Associated targets represented by AIS target symbols</p>  <hr/> <p>Associated targets represented by radar target symbols</p> 
<p>Activated AIS targets - heading lines - turn indicators</p>	

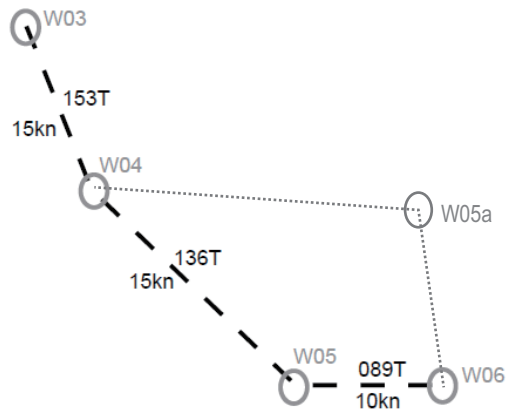
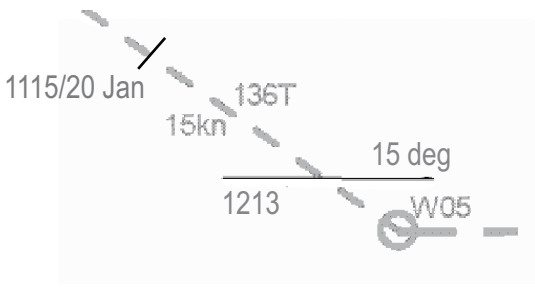
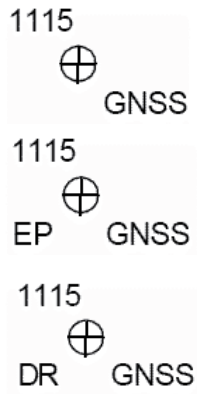
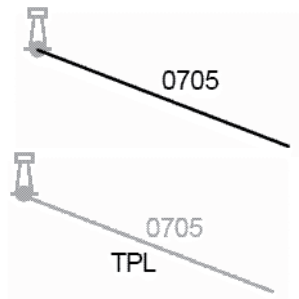
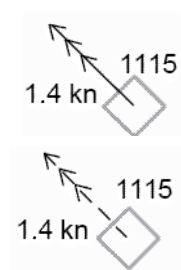

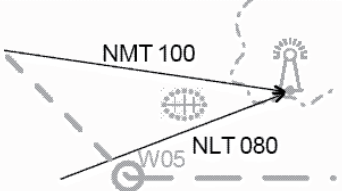



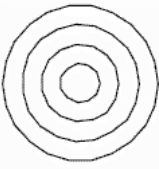
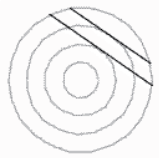

Symbol name and description	Symbol graphic(s)
<p>Velocity vectors</p>	<p>Radar target velocity vectors</p>  <hr/> <p>AIS target velocity vectors</p>  <hr/> <p>Associated target velocity vectors</p> 
<p>Target past positions</p>	<p>Radar target past positions</p>  <hr/> <p>AIS target past positions</p>  <hr/> <p>Associated target past positions</p> 
<p>AIS aid to navigation (ATON) Real ATON is without "V" and virtual ATON is with "V". An ATON in off position is yellow.</p>	
<p>AIS search and rescue transmitter -SART Light-blue in color.</p>	
<p>AIS base station Light-blue in color.</p>	

Symbol name and description	Symbol graphic(s)
AIS SAR vessel Green in color.	
AIS aircraft Green in color.	
Selected targets	<div data-bbox="786 450 1345 658"> <p>Selected radar targets</p>  </div> <div data-bbox="786 665 1345 909"> <p>Selected AIS targets</p>  </div> <div data-bbox="786 916 1345 1160"> <p>Selected association targets</p>  </div> <div data-bbox="786 1167 1345 1312"> <p>Selected AIS ATON</p>  </div> <div data-bbox="786 1319 1345 1480"> <p>Selected AIS SART</p>  </div>
Waypoint	
Next waypoint	





Symbol name and description	Symbol graphic(s)
<p>Routes - Monitor Monitored route leg lines are dashed. Leg lines may indicate planned speed and bearing.</p>	
<p>Wheel over position</p>	
<p>Plotted positions Plotted position includes some labels. Type is DR, EP or Fix (Fix is without label). Examples of source labels are GNSS: G GPS: G DGPS: dG Loran: L etc.</p>	
<p>Line of position Abbreviation is LOP. Label TPL is used to indicate measurement transferred by dead reckoning.</p>	
<p>Tidal stream User defined tidal stream symbols are available as part of User Chart. Actual tidal stream use solid vector and predicted tidal stream use dashed vector.</p>	

Symbol name and description	Symbol graphic(s)
<p>Danger highlight Route Plan, Route Monitor and own ship Chart Alarm search area use danger highlight to indicate violation against user selected dangers.</p>	
<p>Danger bearing Also called by traditional name clearing line. User defined clearing line symbols are available as part of User Chart.</p>	
<p>Event marker Event markers indicate events recorded into the Voyage record. The Man overboard event marker has the label "MOB".</p>	
<p>User cursor</p>	
<p>Electronic bearing line (EBL) Second example show with range marker.</p>	
<p>Variable range marker (VRM)</p>	
<p>Range rings</p>	
<p>Parallel index lines</p>	

Symbols on operating buttons

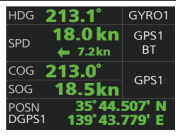
Symbol	Meaning	Symbol	Meaning
	Minimize button (on InstantAccess bar)		Screenshot capture
	Access AIS, Navtex message processing		Adjust monitor brilliance. The sharing method is shown as "S" (System) or "L" (Local).
	Access user profile, common settings		Color palette selection. The sharing method is shown as "S" (System) or "L" (Local).
	Information (show program no., operator's manual)		Activate weather display
	Undo, redo		

APPX. 3 DATA COLOR AND MEANING

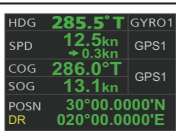
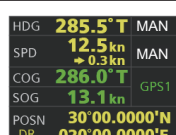
	Indication color	Sensor color	HDG	L/L	SPD	COG/SOG	Display example
SYSTEM/ LOCAL	GRN	WHT	THS-A HDT	GNS-A, D, F, P, R GGA-1, 2, 3, 4, 5 GLL-A, D and (status: A) RMC-A, D, F, P, R and (status: A) *1	VBW-A VHW	VTG-A,D,P RMC-A, D, F, P, R and (status: A) *1	 All values in green.
	YEL	WHT		DGPS update interval in GGA, GNS sentence is higher than 10 seconds. GNS-A, D, F, P, R RMC-A, D, F, P, R and (status: A) *2		RMC-A,D, F, P, R and (status: A) *2	 Position in yellow characters.
	YEL-ORG	WHT		GNS-E,M,S GGA-6,7,8 GLL-E,M,S and (status: A) RMC-E,M,S and (status: A)	VBW (SOG: without either of Field 4 or 5)	VTG-E,M,S RMC-E,M,S and (status: A)	 SPD, COG, SOG and POSN values and pos. source name in yellow-orange.
	GRN (***)	WHT	THS-E, M, S: Invalid HDT: Invalid No sentences	GNS-N: Invalid GGA-0: Invalid GLL-N or (status: V): Invalid RMC-N or (status: V): Invalid No sentences	VBW-V: Invalid VHW: Invalid No sentences	VTG-N: Invalid RMC-N or (status: V): Invalid No sentences	 HDG value shown with asterisks.
	GRN	YEL (DR)		Internally calculated due to loss of communication with sensor. (Dead Reckoning)			 Position in green characters, DR in yellow characters.
MANUAL	YEL	WHT (MAN) (DR)	Manual setting value (Type A or B) Correction setting value (Local setting)	Manual setting value (Dead Reckoning)	Manual setting value	 HDG, SPD and POSN values in yellow characters and "MAN" in white characters.	

*1: Navigational status in RMC, GNS sentence shown in "S", "V" only (IEC 61162-1 Ed. 4 or later).

*2: Navigational status in RMC, GNS sentence shown in "C", "U", "null" only (IEC 61162-1 Ed. 4 or later).

*3: "CORR1" replaces "MAN" in case of heading offset.

APPX. 4 ALERT LIST

Some alerts are presented on-screen as Aggregated (grouped) alerts, with a designated “Aggregated Alert Name”. Alerts which are presented as aggregated alerts are highlighted in the list with a gray background. Non-highlighted alerts have no aggregated alert name. The following table shows the aggregated alert name with the corresponding ALF alert number.

Aggregated Alert Name	ALF No.*	Aggregated Alert Name	ALF No.*
Crossing special area	173,x	Sensor COM Error	30400,x
Datum Mismatch	175,x	Sensor Banned	30500,x
Target Capacity	190,x	No Filter Source of Data	30510,x
HW Status Notice	30001,x	Sensor data Not Available	30601,x
HW Status Abnormal	30002,x	Source Change in use	30602,x
Serial Ch. COM Timeout	30050,x	Sensor data Not Available	30603,x
Crossing special area	30173,x	RM Stop	30800,x
Network COM Timeout	30300,x		

*: “x” indicates instance number.

The following table lists the possible alerts for this equipment. Each alert is listed with priority, category and escalation. This equipment can output alerts in ALF or ALR format. The alert number depends on the output format and may differ between formats.

The default escalation time is 60 seconds, with the exception of the following:

- Alert 150 Early Course Change: 30 seconds
- Alert 495 (ALF format: 30802) Anchor Watch: (120 seconds)

Alerts which are not acknowledged within the set time limit are escalated to either Alarm level (**), or are repeated as a warning(*). If you require a different time limit or different level, see section 22.5.

You can change the priority for some alerts from the [Chart Alerts] page (see section 8.1.2).

Alert No.		Alert Name, Meaning and Remedy	Priority/Category
ALF	ALR		
115 -	115	Name: Loss of System Communication* Meaning: Loss of communication between processor unit and external equipment. Remedy: Check that the device is securely connected.	Warning/B
150,-	150	Name: Early Course Change* Meaning: Waypoint is soon being approached. Ship's position is less than set time of prewarning from WOL. Default: 90 seconds Remedy: Be careful that WPT is approaching.	Warning/A
158,-	158	Name: Course Difference* Meaning: Waypoint is now being approached. When alert 150 and 151 are not acknowledged, ship crosses WOL. When alert 150 is not acknowledged, this is generated instead of alert 151. (30 seconds before WOL) Remedy: Be careful that ship crossed WPT.	Warning/A

APPX. 4 ALERT LIST

Alert No.		Alert Name, Meaning and Remedy	Priority/Category
ALF	ALR		
159,-	159	Name: Low Speed* Meaning: While carrying out TCS, ship's speed becomes less than set value. Remedy: Raise speed or stop track control.	Warning/B
170,-	170	Name: Positioning System Failure* Meaning: All position data has been lost for more than 30 seconds. Remedy: Check the connection with all GPS.	Warning/B
171,-	171	Name: Crossing Safety Contour Meaning: When a check area is set, the vessel entered a shallower area than the threshold set in [Safety Contour]. Remedy: Reconfirm Safety Contour setting or change the course.	Alarm/A
172,-	172	Name: Off Track Alarm Meaning: Deviation is big between planning course and current heading. While monitoring route, ship position deviates XTD Limit. Remedy: Reconfirm XTD Limit or keep own ship inside of channel limit.	Alarm/A
173,1	620	Name: User Chart Danger Area* Meaning: A User Chart Danger Area that is set to Warning/Caution in chart alert is detected inside the check area. Remedy: Be careful of the object mentioned here, on ship's direction.	Warning/A
173,2	621	Name: Traffic Separation Zone* Meaning: A Traffic Separation Zone that is set to Warning/Caution in chart alert is detected inside the check area. Remedy: Be careful of the object mentioned here, on ship's direction.	Warning/A
173,3	622	Name: Inshore Traffic Zone* Meaning: An Inshore Traffic Zone that is set to Warning/Caution in chart alert is detected inside the check area. Remedy: Be careful of the object mentioned here, on ship's direction.	Warning/A
173,4	623	Name: Restricted Area* Meaning: A Restricted Area that is set to Warning/Caution in chart alert is detected inside the check area. Remedy: Be careful of the object mentioned here, on ship's direction.	Warning/A
173,5	624	Name: Caution Area* Meaning: A Caution Area that is set to Warning/Caution in chart alert is detected inside the check area. Remedy: Be careful of the object mentioned here, on ship's direction.	Warning/A
173,6	625	Name: Offshore Production Area* Meaning: An Offshore Production Area that is set to Warning/Caution in chart alert is detected inside the check area. Remedy: Be careful of the object mentioned here, on ship's direction.	Warning/A

Alert No.		Alert Name, Meaning and Remedy	Priority/ Category
ALF	ALR		
173,7	626	Name: Military Practice Area* Meaning: A Military Protection Area that is set to Warning/Caution in chart alert is detected inside the check area. Remedy: Be careful of the object mentioned here, on ship's direction.	Warning/A
173,8	627	Name: Seaplane Landing Area* Meaning: A Seaplane Landing Area that is set to Warning/Caution in chart alert is detected inside the check area. Remedy: Be careful of the object mentioned here, on ship's direction.	Warning/A
173,9	628	Name: Submarine Transit Lane* Meaning: A Submarine Transit Lane that is set to Warning/Caution in chart alert is detected inside the check area. Remedy: Be careful of the object mentioned here, on ship's direction.	Warning/A
173,10	629	Name: Anchorage Area* Meaning: An Anchorage Area that is set to Warning/Caution in chart alert is detected inside the check area. Remedy: Be careful of the object mentioned here, on ship's direction.	Warning/A
173,11	630	Name: Marine Farm/Aquaculture* Meaning: A Marine Farm/Aquaculture that is set to Warning/Caution in chart alert is detected inside the check area. Remedy: Be careful of the object mentioned here, on ship's direction.	Warning/A
173,12	631	Name: PSSA Area* Meaning: A PSSA Area that is set to Warning/Caution in chart alert is detected inside the check area. Remedy: Be careful of the object mentioned here, on ship's direction.	Warning/A
173,13	632	Name: Areas to be Avoided* Meaning: An Areas to be Avoided that is set to Alarm in chart alert is detected inside the check area. Remedy: Be careful of the object mentioned here, on ship's direction.	Warning/A
174-	174	Name: WPT Approach* Meaning: If this ECDIS is connected in the network to an FMD-3200/3300 ECDIS that is interfaced with an IEC 62065 Ed.2 compliant TCS (YDK Technologies PT-900, Tokyo Keiki PR-9000, EMRI FAP-3000, Raytheon Anschutz NP-5400), this alert is generated at each waypoint if the TCS is not connected to the ECDIS in route monitoring. Check ECDIS and network connections. 175 1 455 EPFS1 Invalid/ missing datum Warning/ B Ship position data from No.1 GPS has been discontinued for more than set time.(Set at installation) Default: 60 seconds No.1 GPS is turned off, or there is a problem with network. Remedy: Check ECDIS and network connections.	Warning/A

Alert No.		Alert Name, Meaning and Remedy	Priority/ Category
ALF	ALR		
175,1	455	<p>Name: EPFS1 Invalid/missing datum*</p> <p>Meaning: Ship position data from No.1 GPS has been discontinued for more than set time. (Set at installation) Default: 60 seconds No.1 GPS is turned off, or there is a problem with network.</p> <p>Remedy: Check the connection with No.1 GPS and network.</p>	Warning/B
175,2	456	<p>Name: EPFS2 Invalid/missing datum*</p> <p>Meaning: Ship position data from No.2 GPS has been discontinued for more than set time. (Set at installation) Default: 60 seconds No.2 GPS is turned off, or there is a problem with network.</p> <p>Remedy: Check the connection with No.2 GPS and network.</p>	Warning/B
175,3	457	<p>Name: EPFS3 Invalid/missing datum*</p> <p>Meaning: Ship position data from No.3 GPS has been discontinued for more than set time. (Set at installation) Default: 60 seconds No.3 GPS is turned off, or there is a problem with network.</p> <p>Remedy: Check the connection with No.3 GPS and network.</p>	Warning/B
175,4	458	<p>Name: EPFS4 Invalid/missing datum*</p> <p>Meaning: Ship position data from No.4 GPS has been discontinued for more than set time. (Set at installation) Default: 60 seconds No.4 GPS is turned off, or there is a problem with network.</p> <p>Remedy: Check the connection with No.4 GPS and network.</p>	Warning/B
175,5	459	<p>Name: EPFS5 Invalid/missing datum*</p> <p>Meaning: Ship position data from No.5 GPS has been discontinued for more than set time.(Set at installation) Default: 60 seconds No.5 GPS is turned off, or there is a problem with network.</p> <p>Remedy: Check the connection with No.5 GPS and network.</p>	Warning/B
175,6	460	<p>Name: EPFS6 Invalid/missing datum*</p> <p>Meaning: Ship position data from No.6 GPS has been discontinued for more than set time. (Set at installation) Default: 60 seconds No.6 GPS is turned off, or there is a problem with network.</p> <p>Remedy: Check the connection with No.6 GPS and network.</p>	Warning/B
175,7	461	<p>Name: EPFS7 Invalid/missing datum*</p> <p>Meaning: Ship position data from No.7 GPS has been discontinued for more than set time. (Set at installation) Default: 60 seconds No.7 GPS is turned off, or there is a problem with network.</p> <p>Remedy: Check the connection with No.7 GPS and network.</p>	Warning/B
175,8	462	<p>Name: EPFS8 Invalid/missing datum*</p> <p>Meaning: Ship position data from No.8 GPS has been discontinued for more than set time. (Set at installation) Default: 60 seconds No.8 GPS is turned off, or there is a problem with network.</p> <p>Remedy: Check the connection with No.8 GPS and network.</p>	Warning/B
175,9	463	<p>Name: EPFS9 Invalid/missing datum*</p> <p>Meaning: Ship position data from No.9 GPS has been discontinued for more than set time. (Set at installation) Default: 60 seconds No.9 GPS is turned off, or there is a problem with network.</p> <p>Remedy: Check the connection with No.9 GPS and network.</p>	Warning/B

Alert No.		Alert Name, Meaning and Remedy	Priority/ Category
ALF	ALR		
175,10	464	Name: EPFS10 Invalid/missing datum* Meaning: Ship position data from No.10 GPS has been discontinued for more than set time. (Set at installation) Default: 60 seconds No.10 GPS is turned off, or there is a problem with network. Remedy: Check the connection with No.10 GPS and network.	Warning/B
190,1	531	Name: AIS Target Display 100%* Meaning: 100% of maximum number of target which can be displayed is used. Remedy: The number of AIS target became 100% of that can be displayed. Change the display number using filter function.	Warning/A
190,2	533	Name: AIS Target Display 100%* Meaning: 100% of memory capacity for AIS targets is filled. Remedy: Memory for AIS targets is filled 100%. Cancel unnecessary targets.	Warning/A
190,3	535	Name: AIS Target Activate 100%* Meaning: 100% of capacity for active AIS is filled. Remedy: The number of active AIS target became 100% of its limit. Change the unnecessary targets to sleep mode.	Warning/A
30001,17	073	Name: Processor Unit CPU Temp High Meaning: CPU temperature in processor unit exceeds threshold. Remedy: Turn off Processor Unit. If same error occurs after a few minutes, contact FURUNO.	Caution/B
30001,19	075	Name: Processor Unit CPU Board Temp High Meaning: CPU temperature in processor unit exceeds threshold. Remedy: Turn off Processor Unit. If same error occurs after a few minutes, contact FURUNO.	Caution/B
30001,23	079	Name: Processor Unit Fan1 Rotation Speed Lowering Meaning: Rotation speed of fan1 in processor unit is below threshold. Remedy: If the error frequently occurs, contact FURUNO and inform frequency of occurrence.	Caution/B
30001,26	089	Name: Processor Unit CPU board Battery Power Error Meaning: CPU board battery voltage in processor unit is out of threshold. Remedy: Turn off Processor Unit. If same error occurs after a few minutes, contact FURUNO.	Caution/B
30001,27	090	Name: Processor Unit CPU board Core Power Error Meaning: CPU board core voltage in processor unit is out of threshold. Remedy: Turn off Processor Unit. If same error occurs after a few minutes, contact FURUNO.	Caution/B
30001,31	400	Name: Network Printer Not Available Meaning: When executing printout, network printer is not recognized, network printer connection is interrupted, or printer error such as paper shortage, paper jam and run out of ink occurs. Remedy: Check that the printer is connected to network or printer errors such as paper shortage, paper jam and run out of ink does not occur.	Caution/B

APPX. 4 ALERT LIST

Alert No.		Alert Name, Meaning and Remedy	Priority/Category
ALF	ALR		
30001,32	401	<p>Name: Local Printer Not Available</p> <p>Meaning: When executing printout, local printer is not recognized, local printer connection is interrupted, or printer error such as paper shortage, paper jam and run out of ink occurs.</p> <p>Remedy: Check that the printer is connected to network or printer errors such as paper shortage, paper jam and run out of ink does not occur.</p>	Caution/B
30002,14	083	<p>Name: Processor Unit Fan1 Fan No Rotation*</p> <p>Meaning: Rotation speed of fan1 in processor unit is below threshold.</p> <p>Remedy: If the error frequently occurs, contact FURUNO and inform frequency of occurrence.</p>	Warning/B
30002,17	086	<p>Name: Processor Unit CPU board 5V Power Error*</p> <p>Meaning: 5 V power voltage of CPU board in processor unit is out of threshold.</p> <p>Remedy: If the error frequently occurs, contact FURUNO and inform frequency of occurrence.</p>	Warning/B
30002,18	087	<p>Name: Processor Unit CPU board 3.3V Power Error*</p> <p>Meaning: 3.3 V power voltage of CPU board in processor unit is out of threshold.</p> <p>Remedy: If the error frequently occurs, contact FURUNO and inform frequency of occurrence.</p>	Warning/B
30002,19	088	<p>Name: Processor Unit CPU board 12V Power Error*</p> <p>Meaning: 12 V power voltage of CPU board in processor unit is out of threshold.</p> <p>Remedy: If the error frequently occurs, contact FURUNO and inform frequency of occurrence.</p>	Warning/B
30050,1	320	<p>Name: Processor Unit Ch.01 COM Timeout</p> <p>Meaning: Input from EC-3000 serial ch.1 has been discontinued for more than certain time.(Set at installation) Default: No timeout</p> <p>Remedy: Check the connection of Ch.1.</p>	Caution/B
30050,2	321	<p>Name: Processor Unit Ch.02 COM Timeout</p> <p>Meaning: Input from EC-3000 serial ch.2 has been discontinued for more than certain time.(Set at installation) Default: No timeout</p> <p>Remedy: Check the connection of Ch.2.</p>	Caution/B
30050,3	322	<p>Name: Processor Unit Ch.03 COM Timeout</p> <p>Meaning: Input from EC-3000 serial ch.3 has been discontinued for more than certain time.(Set at installation) Default: No timeout</p> <p>Remedy: Check the connection of Ch.3.</p>	Caution/B
30050,4	323	<p>Name: Processor Unit Ch.04 COM Timeout</p> <p>Meaning: Input from EC-3000 serial ch.4 has been discontinued for more than certain time.(Set at installation) Default: No timeout</p> <p>Remedy: Check the connection of Ch.4.</p>	Caution/B

Alert No.		Alert Name, Meaning and Remedy	Priority/ Category
ALF	ALR		
30173,1	634	<p>Name: UKC Limit*</p> <p>Meaning: Measured depth from echo sounder is less than set UKC limit value.</p> <p>Remedy: Be careful that measured depth is less than UKC limit.</p>	Warning/A
30173,2	635	<p>Name: Non-official ENC*</p> <p>Meaning: When Non-official ENC is set to Warning/Caution in chart alert, the non-official chart area is detected inside the check area.</p> <p>Remedy: Be careful of the object mentioned here, on ship's direction.</p>	Warning/A
30173,3	636	<p>Name: No Vector Chart*</p> <p>Meaning: When No Vector Chart is set to Warning/Caution in chart alert, the No Vector Chart area is detected inside the check area.</p> <p>Remedy: Be careful of the object mentioned here, on ship's direction.</p>	Warning/A
30173,4	637	<p>Name: Not Up-to-date*</p> <p>Meaning: When Not Up to Date is set to Warning/Caution in chart alert, a chart area that is not up-to-date is detected inside the check area.</p> <p>Remedy: Be careful of the object mentioned here, on ship's direction.</p>	Warning/A
30173,5	638	<p>Name: Permit Expired*</p> <p>Meaning: When Permit Expired is set to Warning/Caution in chart alert, a chart area that has an expired permit is detected inside the check area.</p> <p>Remedy: Be careful of the object mentioned here, on ship's direction.</p>	Warning/A
30173,6	646	<p>Name: Sounding UKC Limit*</p> <p>Meaning: Chart depth for one or more legs is outside the UKC threshold.</p> <p>Remedy: Adjust course accordingly.</p>	Warning/A
30173,7	647	<p>Name: Too Many Dangers*</p> <p>Meaning: Selected route and look-ahead area have too many dangerous objects.</p> <p>Remedy: The check area may not be completely checked for dangerous objects. Make the route or look-ahead area smaller.</p>	Warning/A
30300,1	030	<p>Name: Sensor Adapter 1 COM Timeout</p> <p>Meaning: Communication error with No.1 sensor adapter is detected. 30 seconds timeout. No.1 sensor adapter is turned off, or there is a problem with network.</p> <p>Remedy: Check the connection with No.1 sensor adapter and network.</p>	Caution/B
30300,2	031	<p>Name: Sensor Adapter 2 COM Timeout</p> <p>Meaning: Communication error with No.2 sensor adapter is detected. 30 seconds timeout. No.2 sensor adapter is turned off, or there is a problem with network.</p> <p>Remedy: Check the connection with No.2 sensor adapter and network.</p>	Caution/B

Alert No.		Alert Name, Meaning and Remedy	Priority/ Category
ALF	ALR		
30300,3	032	<p>Name: Sensor Adapter 3 COM Timeout</p> <p>Meaning: Communication error with No.3 sensor adapter is detected. 30 seconds timeout. No.3 sensor adapter is turned off, or there is a problem with network.</p> <p>Remedy: Check the connection with No.3 sensor adapter and network.</p>	Caution/B
30300,4	033	<p>Name: Sensor Adapter 4 COM Timeout</p> <p>Meaning: Communication error with No.4 sensor adapter is detected. 30 seconds timeout. No.4 sensor adapter is turned off, or there is a problem with network.</p> <p>Remedy: Check the connection with No.4 sensor adapter and network.</p>	Caution/B
30300,5	034	<p>Name: Sensor Adapter 5 COM Timeout</p> <p>Meaning: Communication error with No.5 sensor adapter is detected. 30 seconds timeout. No.5 sensor adapter is turned off, or there is a problem with network.</p> <p>Remedy: Check the connection with No.5 sensor adapter and network.</p>	Caution/B
30300,6	035	<p>Name: Sensor Adapter 6 COM Timeout</p> <p>Meaning: Communication error with No.6 sensor adapter is detected. 30 seconds timeout. No.6 sensor adapter is turned off, or there is a problem with network.</p> <p>Remedy: Check the connection with No.6 sensor adapter and network.</p>	Caution/B
30300,7	036	<p>Name: Sensor Adapter 7 COM Timeout</p> <p>Meaning: Communication error with No.7 sensor adapter is detected. 30 seconds timeout. No.7 sensor adapter is turned off, or there is a problem with network.</p> <p>Remedy: Check the connection with No.7 sensor adapter and network.</p>	Caution/B
30300,8	037	<p>Name: Sensor Adapter 8 COM Timeout</p> <p>Meaning: Communication error with No.8 sensor adapter is detected. 30 seconds timeout. No.8 sensor adapter is turned off, or there is a problem with network.</p> <p>Remedy: Check the connection with No.8 sensor adapter and network.</p>	Caution/B
30300,9	038	<p>Name: Sensor Adapter 9 COM Timeout</p> <p>Meaning: Communication error with No.9 sensor adapter is detected. 30 seconds timeout. No.9 sensor adapter is turned off, or there is a problem with network.</p> <p>Remedy: Check the connection with No.9 sensor adapter and network.</p>	Caution/B
30300,10	039	<p>Name: Sensor Adapter 10 COM Timeout</p> <p>Meaning: Communication error with No.10 sensor adapter is detected. 30 seconds timeout. No.10 sensor adapter is turned off, or there is a problem with network.</p> <p>Remedy: Check the connection with No.10 sensor adapter and network.</p>	Caution/B
30300,11	094	<p>Name: Sensor Adapter 11 COM Timeout</p> <p>Meaning: Communication error with No.11 sensor adapter is detected. 30 seconds timeout. No.11 sensor adapter is turned off, or there is a problem with network.</p> <p>Remedy: Check the connection with No.11 sensor adapter and network.</p>	Caution/B

Alert No.		Alert Name, Meaning and Remedy	Priority/ Category
ALF	ALR		
30300,12	095	Name: Sensor Adapter 12 COM Timeout Meaning: Communication error with No.12 sensor adapter is detected. 30 seconds timeout. No.12 sensor adapter is turned off, or there is a problem with network. Remedy: Check the connection with No.12 sensor adapter and network.	Caution/B
30300,13	096	Name: Sensor Adapter 13 COM Timeout Meaning: Communication error with No.13 sensor adapter is detected. 30 seconds timeout. No.13 sensor adapter is turned off, or there is a problem with network. Remedy: Check the connection with No.13 sensor adapter and network.	Caution/B
30300,14	097	Name: Sensor Adapter 14 COM Timeout Meaning: Communication error with No.14 sensor adapter is detected. 30 seconds timeout. No.14 sensor adapter is turned off, or there is a problem with network. Remedy: Check the connection with No.14 sensor adapter and network.	Caution/B
30300,15	098	Name: Sensor Adapter 15 COM Timeout Meaning: Communication error with No.15 sensor adapter is detected. 30 seconds timeout. No.15 sensor adapter is turned off, or there is a problem with network. Remedy: Check the connection with No.15 sensor adapter and network.	Caution/B
30300,16	099	Name: Sensor Adapter 16 COM Timeout Meaning: Communication error with No.16 sensor adapter is detected. 30 seconds timeout. No.16 sensor adapter is turned off, or there is a problem with network. Remedy: Check the connection with No.16 sensor adapter and network.	Caution/B
30310,-	510	Name: IAS COM Timeout (MODBUS)* Meaning: Connection to the IAS (MODBUS) is loss or interrupted. Remedy: Check connection.	Warning/B
30380,131	380	Name: AIS COM Error* Meaning: Data from AIS has been discontinued for more than set time. (Set at installation) Default: 60 seconds AIS is turned off, or there is a problem with network. Remedy: Check the connection with AIS and network.	Warning/B
30400,1	255	Name: Gyro 1 COM Error Meaning: Data from No.1 gyro has been discontinued for more than set time. (Set at installation) Default: 60 seconds Remedy: No.1 gyro is turned off, or there is a problem with network.	Caution/B
30400,2	256	Name: Gyro 2 COM Error Meaning: Data from No.2 gyro has been discontinued for more than set time. (Set at installation) Default: 60 seconds Remedy: No.2 gyro is turned off, or there is a problem with network.	Caution/B

APPX. 4 ALERT LIST

Alert No.		Alert Name, Meaning and Remedy	Priority/ Category
ALF	ALR		
30400,3	257	<p>Name: Gyro 3 COM Error</p> <p>Meaning: Data from No.3 gyro has been discontinued for more than set time. (Set at installation) Default: 60 seconds</p> <p>Remedy: No.3 gyro is turned off, or there is a problem with network.</p>	Caution/B
30400,4	258	<p>Name: Gyro 4 COM Error</p> <p>Meaning: Data from No.4 gyro has been discontinued for more than set time. (Set at installation) Default: 60 seconds</p> <p>Remedy: No.4 gyro is turned off, or there is a problem with network.</p>	Caution/B
30400,5	259	<p>Name: Gyro 5 COM Error</p> <p>Meaning: Data from No.5 gyro has been discontinued for more than set time. (Set at installation) Default: 60 seconds</p> <p>Remedy: No.5 gyro is turned off, or there is a problem with network.</p>	Caution/B
30400,11	391	<p>Name: ROT Gyro 1 COM Error</p> <p>Meaning: Data from No.1 ROT gyro has been discontinued for more than set time. (Set at installation) Default: 60 seconds</p> <p>Remedy: Check the connection with No.1 ROT gyro.</p>	Caution/B
30400,12	392	<p>Name: ROT Gyro 2 COM Error</p> <p>Meaning: Data from No.2 ROT gyro has been discontinued for more than set time. (Set at installation) Default: 60 seconds</p> <p>Remedy: Check the connection with No.2 ROT gyro.</p>	Caution/B
30400,13	393	<p>Name: ROT Gyro 3 COM Error</p> <p>Meaning: Data from No.3 ROT gyro has been discontinued for more than set time. (Set at installation) Default: 60 seconds</p> <p>Remedy: Check the connection with No.3 ROT gyro.</p>	Caution/B
30400,21	290	<p>Name: EPFS 1 COM Error</p> <p>Meaning: Ship position data from No.1 GPS has been discontinued for more than set time. (Set at installation) Default: 60 seconds</p> <p>Remedy: No.1 GPS is turned off, or there is a problem with network.</p>	Caution/B
30400,22	291	<p>Name: EPFS 2 COM Error</p> <p>Meaning: Ship position data from No.2 GPS has been discontinued for more than set time. (Set at installation) Default: 60 seconds</p> <p>Remedy: No.2 GPS is turned off, or there is a problem with network.</p>	Caution/B
30400,23	292	<p>Name: EPFS 3 COM Error</p> <p>Meaning: Ship position data from No.3 GPS has been discontinued for more than set time. (Set at installation) Default: 60 seconds</p> <p>Remedy: No.3 GPS is turned off, or there is a problem with network.</p>	Caution/B

Alert No.		Alert Name, Meaning and Remedy	Priority/ Category
ALF	ALR		
30400,24	293	<p>Name: EPFS 4 COM Error</p> <p>Meaning: Ship position data from No.4 GPS has been discontinued for more than set time. (Set at installation) Default: 60 seconds</p> <p>Remedy: No.4 GPS is turned off, or there is a problem with network.</p>	Caution/B
30400,25	294	<p>Name: EPFS 5 COM Error</p> <p>Meaning: Ship position data from No.5 GPS has been discontinued for more than set time. (Set at installation) Default: 60 seconds</p> <p>Remedy: No.5 GPS is turned off, or there is a problem with network.</p>	Caution/B
30400,26	295	<p>Name: EPFS 6 COM Error</p> <p>Meaning: Ship position data from No.6 GPS has been discontinued for more than set time. (Set at installation) Default: 60 seconds</p> <p>Remedy: No.6 GPS is turned off, or there is a problem with network.</p>	Caution/B
30400,27	296	<p>Name: EPFS 7 COM Error</p> <p>Meaning: Ship position data from No.7 GPS has been discontinued for more than set time. (Set at installation) Default: 60 seconds</p> <p>Remedy: No.7 GPS is turned off, or there is a problem with network.</p>	Caution/B
30400,28	297	<p>Name: EPFS 8 COM Error</p> <p>Meaning: Ship position data from No.8 GPS has been discontinued for more than set time. (Set at installation) Default: 60 seconds</p> <p>Remedy: No.8 GPS is turned off, or there is a problem with network.</p>	Caution/B
30400,29	298	<p>Name: EPFS 9 COM Error</p> <p>Meaning: Ship position data from No.9 GPS has been discontinued for more than set time. (Set at installation) Default: 60 seconds</p> <p>Remedy: No.9 GPS is turned off, or there is a problem with network.</p>	Caution/B
30400,30	299	<p>Name: EPFS 10 COM Error</p> <p>Meaning: Ship position data from No.10 GPS has been discontinued for more than set time. (Set at installation) Default: 60 seconds</p> <p>Remedy: No.10 GPS is turned off, or there is a problem with network.</p>	Caution/B
30400,41	280	<p>Name: SDME 1 COM Error</p> <p>Meaning: Speed data from No.1 SDME has been discontinued for more than set time. (Set at installation) Default: 60 seconds No.1 SDME is turned off, or there is a problem with network.</p> <p>Remedy: Check the connection with No.1 SDME and network.</p>	Caution/B
30400,42	281	<p>Name: SDME 2 COM Error</p> <p>Meaning: Speed data from No.2 SDME has been discontinued for more than set time. (Set at installation) Default: 60 seconds No.2 SDME is turned off, or there is a problem with network.</p> <p>Remedy: Check the connection with No.2 SDME and network.</p>	Caution/B

APPX. 4 ALERT LIST

Alert No.		Alert Name, Meaning and Remedy	Priority/ Category
ALF	ALR		
30400,43	282	<p>Name: SDME 3 COM Error</p> <p>Meaning: Speed data from No.3 SDME has been discontinued for more than set time. (Set at installation) Default: 60 seconds No.3 SDME is turned off, or there is a problem with network.</p> <p>Remedy: Check the connection with No.3 SDME and network.</p>	Caution/B
30400,51	235	<p>Name: Echo Sounder 1 COM Error</p> <p>Meaning: Input of depth data from No.1 echo sounder has been discontinued for more than set time. (Set at installation) Default: 60 seconds</p> <p>Remedy: No.1 echo sounder is turned off, or there is a problem with network.</p>	Caution/B
30400,52	236	<p>Name: Echo Sounder 2 COM Error</p> <p>Meaning: Input of depth data from No.2 echo sounder has been discontinued for more than set time. (Set at installation) Default: 60 seconds</p> <p>Remedy: No.2 echo sounder is turned off, or there is a problem with network.</p>	Caution/B
30400,53	237	<p>Name: Echo Sounder 3 COM Error</p> <p>Meaning: Input of depth data from No.3 echo sounder has been discontinued for more than set time. (Set at installation) Default: 60 seconds</p> <p>Remedy: No.3 echo sounder is turned off, or there is a problem with network.</p>	Caution/B
30400,61	300	<p>Name: Rudder 1 COM Error</p> <p>Meaning: Rudder data from No.1 rudder sensor has been discontinued for more than set time. (Set at installation) Default: 60 seconds No.1 Rudder is turned off, or there is a problem with network.</p> <p>Remedy: Check the connection with No.1 rudder sensor and network.</p>	Caution/B
30400,62	301	<p>Name: Rudder 2 COM Error</p> <p>Meaning: Rudder data from No.2 rudder sensor has been discontinued for more than set time. (Set at installation) Default: 60 seconds No.2 Rudder is turned off, or there is a problem with network.</p> <p>Remedy: Check the connection with No.2 rudder sensor and network.</p>	Caution/B
30400,63	302	<p>Name: Rudder 3 COM Error</p> <p>Meaning: Rudder data from No.3 rudder sensor has been discontinued for more than set time. (Set at installation) Default: 60 seconds No.3 Rudder is turned off, or there is a problem with network.</p> <p>Remedy: Check the connection with No.3 rudder sensor and network.</p>	Caution/B
30400,71	303	<p>Name: HCS 1 COM Error</p> <p>Meaning: Data from No.1 HCS has been discontinued for more than set time. (Set at installation) Default: 60 seconds No.1 HCS is turned off, or there is a problem with network.</p> <p>Remedy: Check the connection with No.1 HCS and network.</p>	Caution/B

Alert No.		Alert Name, Meaning and Remedy	Priority/ Category
ALF	ALR		
30400,72	304	<p>Name: HCS 2 COM Error</p> <p>Meaning: Data from No.2 HCS has been discontinued for more than set time. (Set at installation) Default: 60 seconds No.2 HCS is turned off, or there is a problem with network.</p> <p>Remedy: Check the connection with No.2 HCS and network.</p>	Caution/B
30400, 81	305	<p>Name: VDR COM Error</p> <p>Meaning: Sentence from VDR has been discontinued for more than set time. (Set at installation) Default: 180 seconds VDR is turned off, or there is a problem with network.</p> <p>Remedy: Check the connection with VDR and network.</p>	Caution/B
30400,91	306	<p>Name: BNWAS1 COM Error</p> <p>Meaning: Caution Sentence from BNWAS has been discontinued for more than set time. (Set at installation) Default: 180 seconds BNWAS is turned off, or there is a problem with network.</p> <p>Remedy: Check the connection with BNWAS and network.</p>	Caution/B
30400,92	307	<p>Name: BNWAS2 COM Error</p> <p>Meaning: Caution Sentence from BNWAS2 has been discontinued for more than set time. (Set at installation) Default: 180 seconds BNWAS2 is turned off, or there is a problem with network.</p> <p>Remedy: Check the connection with BNWAS2 and network.</p>	Caution/B
30400,93	308	<p>Name: BNWAS3 COM Error</p> <p>Meaning: Caution Sentence from BNWAS3 has been discontinued for more than set time. (Set at installation) Default: 180 seconds BNWAS3 is turned off, or there is a problem with network.</p> <p>Remedy: Check the connection with BNWAS3 and network.</p>	Caution/B
30400,101	360	<p>Name: Wind Sensor 1 COM Error</p> <p>Meaning: Data from No.1 wind sensor has been discontinued for more than set time. (Set at installation) Default: 60 seconds No.1 wind sensor is turned off, or there is a problem with network.</p> <p>Remedy: Check the connection with No.1 wind sensor.</p>	Caution/B
30400,102	361	<p>Name: Wind Sensor 2 COM Error</p> <p>Meaning: Data from No.2 wind sensor has been discontinued for more than set time. (Set at installation) Default: 60 seconds No.2 wind sensor is turned off, or there is a problem with network.</p> <p>Remedy: Check the connection with No.2 wind sensor.</p>	Caution/B
30400,103	362	<p>Name: Wind Sensor 3 COM Error</p> <p>Meaning: Data from No.3 wind sensor has been discontinued for more than set time. (Set at installation) Default: 60 seconds No.3 wind sensor is turned off, or there is a problem with network.</p> <p>Remedy: Check the connection with No.3 wind sensor.</p>	Caution/B

APPX. 4 ALERT LIST

Alert No.		Alert Name, Meaning and Remedy	Priority/ Category
ALF	ALR		
30400,111	370	<p>Name: Water Current COM Error</p> <p>Meaning: Data from water current has been discontinued for more than set time. (Set at installation) Default: 60 seconds Water current sensor is turned off, or there is a problem with network. Check the connection with water current and network.</p> <p>Remedy: Check the connection with water current and network.</p>	Caution/B
30400,121	371	<p>Name: Water Temp COM Error</p> <p>Meaning: Data from water temp. has been discontinued for more than set time. (Set at installation) Default: 60 seconds Water temp sensor is turned off, or there is a problem with network.</p> <p>Remedy: Check the connection with water temp and network.</p>	Caution/B
30400,141	390	<p>Name: NAVTEX COM Error</p> <p>Meaning: Data from NAVTEX has been discontinued for more than set time. (Set at installation) Default: 180 seconds NAVTEX is turned off, or there is a problem with network.</p> <p>Remedy: Check the connection with NAVTEX and network.</p>	Caution/B
30400,151	310	<p>Name: Other Sensor 1 COM Error</p> <p>Meaning: Data from No.1 other sensor has been discontinued for more than set time. (Set at installation) Default: 180 seconds No.1 other sensor is turned off, or there is a problem with network.</p> <p>Remedy: Check the connection with No.1 other sensor and network.</p>	Caution/B
30400,152	311	<p>Name: Other Sensor 2 COM Error</p> <p>Meaning: Data from No.2 other sensor has been discontinued for more than set time. (Set at installation) Default: 180 seconds No.2 other sensor is turned off, or there is a problem with network.</p> <p>Remedy: Check the connection with No.2 other sensor and network.</p>	Caution/B
30400,153	312	<p>Name: Other Sensor 3 COM Error</p> <p>Meaning: Data from No.3 other sensor has been discontinued for more than set time. (Set at installation) Default: 180 seconds No.3 other sensor is turned off, or there is a problem with network.</p> <p>Remedy: Check the connection with No.3 other sensor and network.</p>	Caution/B
30400,154	313	<p>Name: Other Sensor 4 COM Error</p> <p>Meaning: Data from No.4 other sensor has been discontinued for more than set time. (Set at installation) Default: 180 seconds No.4 other sensor is turned off, or there is a problem with network.</p> <p>Remedy: Check the connection with No.4 other sensor and network.</p>	Caution/B

Alert No.		Alert Name, Meaning and Remedy	Priority/ Category
ALF	ALR		
30400,155	314	<p>Name: Other Sensor 5 COM Error</p> <p>Meaning: Data from No.5 other sensor has been discontinued for more than set time. (Set at installation) Default: 180 seconds No.5 other sensor is turned off, or there is a problem with network.</p> <p>Remedy: Check the connection with No.5 other sensor and network.</p>	Caution/B
30400,156	315	<p>Name: Other Sensor 6 COM Error</p> <p>Meaning: Data from No.6 other sensor has been discontinued for more than set time. (Set at installation) Default: 180 seconds No.6 other sensor is turned off, or there is a problem with network.</p> <p>Remedy: Check the connection with No.6 other sensor and network.</p>	Caution/B
30400,157	316	<p>Name: Other Sensor 7 COM Error</p> <p>Meaning: Data from No.7 other sensor has been discontinued for more than set time. (Set at installation) Default: 180 seconds No.7 other sensor is turned off, or there is a problem with network.</p> <p>Remedy: Check the connection with No.7 other sensor and network.</p>	Caution/B
30400,158	317	<p>Name: Other Sensor 8 COM Error</p> <p>Meaning: Data from No.8 other sensor has been discontinued for more than set time. (Set at installation) Default: 180 seconds No.8 other sensor is turned off, or there is a problem with network.</p> <p>Remedy: Check the connection with No.8 other sensor and network.</p>	Caution/B
30400,159	318	<p>Name: Other Sensor 9 COM Error</p> <p>Meaning: Data from No.9 other sensor has been discontinued for more than set time. (Set at installation) Default: 180 seconds No.9 other sensor is turned off, or there is a problem with network.</p> <p>Remedy: Check the connection with No.9 other sensor and network.</p>	Caution/B
30400,160	319	<p>Name: Other Sensor 10 COM Error</p> <p>Meaning: Data from No.10 other sensor has been discontinued for more than set time. (Set at installation) Default: 180 seconds No.10 other sensor is turned off, or there is a problem with network.</p> <p>Remedy: Check the connection with No.10 other sensor and network.</p>	Caution/B

APPX. 4 ALERT LIST

Alert No.		Alert Name, Meaning and Remedy	Priority/Category
ALF	ALR		
30400,161	411	<p>Name: Other Sensor 11 COM Error</p> <p>Meaning: Data from No.11 other sensor has been discontinued for more than set time. (Set at installation) Default: 180 seconds No.11 other sensor is turned off, or there is a problem with network.</p> <p>Remedy: Check the connection with No.11 other sensor and network.</p>	Caution/B
30400,162	412	<p>Name: Other Sensor 12 COM Error</p> <p>Meaning: Data from No.12 other sensor has been discontinued for more than set time. (Set at installation) Default: 180 seconds No.12 other sensor is turned off, or there is a problem with network.</p> <p>Remedy: Check the connection with No.12 other sensor and network.</p>	Caution/B
30400,163	413	<p>Name: Other Sensor 13 COM Error</p> <p>Meaning: Data from No.13 other sensor has been discontinued for more than set time. (Set at installation) Default: 180 seconds No.13 other sensor is turned off, or there is a problem with network.</p> <p>Remedy: Check the connection with No.13 other sensor and network.</p>	Caution/B
30400,164	414	<p>Name: Other Sensor 14 COM Error</p> <p>Meaning: Data from No.14 other sensor has been discontinued for more than set time. (Set at installation) Default: 180 seconds No.14 other sensor is turned off, or there is a problem with network.</p> <p>Remedy: Check the connection with No.14 other sensor and network.</p>	Caution/B
30400,165	415	<p>Name: Other Sensor 15 COM Error</p> <p>Meaning: Data from No.15 other sensor has been discontinued for more than set time. (Set at installation) Default: 180 seconds No.15 other sensor is turned off, or there is a problem with network.</p> <p>Remedy: Check the connection with No.15 other sensor and network.</p>	Caution/B
30400,166	416	<p>Name: Other Sensor 16 COM Error</p> <p>Meaning: Data from No.16 other sensor has been discontinued for more than set time. (Set at installation) Default: 180 seconds No.16 other sensor is turned off, or there is a problem with network.</p> <p>Remedy: Check the connection with No.16 other sensor and network.</p>	Caution/B

Alert No.		Alert Name, Meaning and Remedy	Priority/ Category
ALF	ALR		
30400,167	417	<p>Name: Other Sensor 17 COM Error</p> <p>Meaning: Data from No.17 other sensor has been discontinued for more than set time. (Set at installation) Default: 180 seconds No.17 other sensor is turned off, or there is a problem with network.</p> <p>Remedy: Check the connection with No.17 other sensor and network.</p>	Caution/B
30400,168	418	<p>Name: Other Sensor 18 COM Error</p> <p>Meaning: Data from No.18 other sensor has been discontinued for more than set time. (Set at installation) Default: 180 seconds No.18 other sensor is turned off, or there is a problem with network.</p> <p>Remedy: Check the connection with No.18 other sensor and network.</p>	Caution/B
30400,169	419	<p>Name: Other Sensor 19 COM Error</p> <p>Meaning: Data from No.19 other sensor has been discontinued for more than set time. (Set at installation) Default: 180 seconds No.19 other sensor is turned off, or there is a problem with network.</p> <p>Remedy: Check the connection with No.19 other sensor and network.</p>	Caution/B
30400,170	420	<p>Name: Other Sensor 20 COM Error</p> <p>Meaning: Data from No.20 other sensor has been discontinued for more than set time. (Set at installation) Default: 180 seconds No.20 other sensor is turned off, or there is a problem with network.</p> <p>Remedy: Check the connection with No.20 other sensor and network.</p>	Caution/B
30400,171	421	<p>Name: Other Sensor 21 COM Error</p> <p>Meaning: Data from No.21 other sensor has been discontinued for more than set time. (Set at installation) Default: 180 seconds No.21 other sensor is turned off, or there is a problem with network.</p> <p>Remedy: Check the connection with No.21 other sensor and network.</p>	Caution/B
30400,172	422	<p>Name: Other Sensor 22 COM Error</p> <p>Meaning: Data from No.22 other sensor has been discontinued for more than set time. (Set at installation) Default: 180 seconds No.22 other sensor is turned off, or there is a problem with network.</p> <p>Remedy: Check the connection with No.22 other sensor and network.</p>	Caution/B

APPX. 4 ALERT LIST

Alert No.		Alert Name, Meaning and Remedy	Priority/Category
ALF	ALR		
30400,173	423	<p>Name: Other Sensor 23 COM Error</p> <p>Meaning: Data from No.23 other sensor has been discontinued for more than set time. (Set at installation) Default: 180 seconds No.23 other sensor is turned off, or there is a problem with network.</p> <p>Remedy: Check the connection with No.23 other sensor and network.</p>	Caution/B
30400,174	424	<p>Name: Other Sensor 24 COM Error</p> <p>Meaning: Data from No.24 other sensor has been discontinued for more than set time. (Set at installation) Default: 180 seconds No.24 other sensor is turned off, or there is a problem with network.</p> <p>Remedy: Check the connection with No.24 other sensor and network.</p>	Caution/B
30400,175	425	<p>Name: Other Sensor 25 COM Error</p> <p>Meaning: Data from No.25 other sensor has been discontinued for more than set time. (Set at installation) Default: 180 seconds No.25 other sensor is turned off, or there is a problem with network.</p> <p>Remedy: Check the connection with No.25 other sensor and network.</p>	Caution/B
30400,176	426	<p>Name: Other Sensor 26 COM Error</p> <p>Meaning: Data from No.26 other sensor has been discontinued for more than set time. (Set at installation) Default: 180 seconds No.26 other sensor is turned off, or there is a problem with network.</p> <p>Remedy: Check the connection with No.26 other sensor and network.</p>	Caution/B
30400,177	427	<p>Name: Other Sensor 27 COM Error</p> <p>Meaning: Data from No.27 other sensor has been discontinued for more than set time. (Set at installation) Default: 180 seconds No.27 other sensor is turned off, or there is a problem with network.</p> <p>Remedy: Check the connection with No.27 other sensor and network.</p>	Caution/B
30400,178	428	<p>Name: Other Sensor 28 COM Error</p> <p>Meaning: Data from No.28 other sensor has been discontinued for more than set time. (Set at installation) Default: 180 seconds No.28 other sensor is turned off, or there is a problem with network.</p> <p>Remedy: Check the connection with No.28 other sensor and network.</p>	Caution/B

Alert No.		Alert Name, Meaning and Remedy	Priority/ Category
ALF	ALR		
30400,179	429	<p>Name: Other Sensor 29 COM Error</p> <p>Meaning: Data from No.29 other sensor has been discontinued for more than set time. (Set at installation) Default: 180 seconds No.29 other sensor is turned off, or there is a problem with network.</p> <p>Remedy: Check the connection with No.29 other sensor and network.</p>	Caution/B
30400,180	430	<p>Name: Other Sensor 30 COM Error</p> <p>Meaning: Data from No.30 other sensor has been discontinued for more than set time. (Set at installation) Default: 180 seconds No.30 other sensor is turned off, or there is a problem with network.</p> <p>Remedy: Check the connection with No.30 other sensor and network.</p>	Caution/B
30431,-	431	<p>Name: HUB-3000 LinkUP Error*</p> <p>Meaning: A network error has occurred between the HUB-3000 and one or more connected units.</p> <p>Remedy: Check network connections between the EC-3000 and networked units.</p>	Warning/B
30500,1	851	<p>Name: EPFS 1 Sensor Banned</p> <p>Meaning: Own ship position data from No.1 GPS is determined abnormal by integrity check.</p> <p>Remedy: Reset the filter to confirm that it isn't a temporal error value. If the data is normal, it is reusable. However, if it's continually removed, there is a possibility that correct data is not received from sensor. In this case, contact FURUNO.</p>	Caution/B
30500,2	852	<p>Name: EPFS 2 Sensor Banned</p> <p>Meaning: Own ship position data from No.2 GPS is determined abnormal by integrity check.</p> <p>Remedy: Reset the filter to confirm that it isn't a temporal error value. If the data is normal, it is reusable. However, if it's continually removed, there is a possibility that correct data is not received from sensor. In this case, contact FURUNO.</p>	Caution/B
30500,3	853	<p>Name: EPFS 3 Sensor Banned</p> <p>Meaning: Own ship position data from No.3 GPS is determined abnormal by integrity check.</p> <p>Remedy: Reset the filter to confirm that it isn't a temporal error value. If the data is normal, it is reusable. However, if it's continually removed, there is a possibility that correct data is not received from sensor. In this case, contact FURUNO.</p>	Caution/B
30500,4	854	<p>Name: EPFS 4 Sensor Banned</p> <p>Meaning: Own ship position data from No.4 GPS is determined abnormal by integrity check.</p> <p>Remedy: Reset the filter to confirm that it isn't a temporal error value. If the data is normal, it is reusable. However, if it's continually removed, there is a possibility that correct data is not received from sensor. In this case, contact FURUNO.</p>	Caution/B

Alert No.		Alert Name, Meaning and Remedy	Priority/ Category
ALF	ALR		
30500,5	855	<p>Name: EPFS 5 Sensor Banned</p> <p>Meaning: Own ship position data from No.5 GPS is determined abnormal by integrity check.</p> <p>Remedy: Reset the filter to confirm that it isn't a temporal error value. If the data is normal, it is reusable. However, if it's continually removed, there is a possibility that correct data is not received from sensor. In this case, contact FURUNO.</p>	Caution/B
30500,6	856	<p>Name: EPFS 6 Sensor Banned</p> <p>Meaning: Own ship position data from No.6 GPS is determined abnormal by integrity check.</p> <p>Remedy: Reset the filter to confirm that it isn't a temporal error value. If the data is normal, it is reusable. However, if it's continually removed, there is a possibility that correct data is not received from sensor. In this case, contact FURUNO.</p>	Caution/B
30500,7	857	<p>Name: EPFS 7 Sensor Banned</p> <p>Meaning: Own ship position data from No.7 GPS is determined abnormal by integrity check.</p> <p>Remedy: Reset the filter to confirm that it isn't a temporal error value. If the data is normal, it is reusable. However, if it's continually removed, there is a possibility that correct data is not received from sensor. In this case, contact FURUNO.</p>	Caution/B
30500,8	858	<p>Name: EPFS 8 Sensor Banned</p> <p>Meaning: Own ship position data from No.8 GPS is determined abnormal by integrity check.</p> <p>Remedy: Reset the filter to confirm that it isn't a temporal error value. If the data is normal, it is reusable. However, if it's continually removed, there is a possibility that correct data is not received from sensor. In this case, contact FURUNO.</p>	Caution/B
30500,9	859	<p>Name: EPFS 9 Sensor Banned</p> <p>Meaning: Own ship position data from No.9 GPS is determined abnormal by integrity check.</p> <p>Remedy: Reset the filter to confirm that it isn't a temporal error value. If the data is normal, it is reusable. However, if it's continually removed, there is a possibility that correct data is not received from sensor. In this case, contact FURUNO.</p>	Caution/B
30500,10	860	<p>Name: EPFS 10 Sensor Banned</p> <p>Meaning: Own ship position data from No.10 GPS is determined abnormal by integrity check.</p> <p>Remedy: Reset the filter to confirm that it isn't a temporal error value. If the data is normal, it is reusable. However, if it's continually removed, there is a possibility that correct data is not received from sensor. In this case, contact FURUNO.</p>	Caution/B
30500,11	871	<p>Name: Gyro 1 Sensor Banned</p> <p>Meaning: Heading data from No.1 Gyro is determined abnormal by integrity check.</p> <p>Remedy: Reset the filter to confirm that it isn't a temporal error value. If the data is normal, it is reusable. However, if it's continually removed, there is a possibility that correct data is not received from sensor. In this case, contact FURUNO.</p>	Caution/B

Alert No.		Alert Name, Meaning and Remedy	Priority/ Category
ALF	ALR		
30500,12	872	<p>Name: Gyro 2 Sensor Banned</p> <p>Meaning: Heading data from No.2 Gyro is determined abnormal by integrity check.</p> <p>Remedy: Reset the filter to confirm that it isn't a temporal error value. If the data is normal, it is reusable. However, if it's continually removed, there is a possibility that correct data is not received from sensor. In this case, contact FURUNO.</p>	Caution/B
30500,13	873	<p>Name: Gyro 3 Sensor Banned</p> <p>Meaning: Heading data from No.3 Gyro is determined abnormal by integrity check.</p> <p>Remedy: Reset the filter to confirm that it isn't a temporal error value. If the data is normal, it is reusable. However, if it's continually removed, there is a possibility that correct data is not received from sensor. In this case, contact FURUNO.</p>	Caution/B
30500,14	874	<p>Name: Gyro 4 Sensor Banned</p> <p>Meaning: Heading data from No.4 Gyro is determined abnormal by integrity check.</p> <p>Remedy: Reset the filter to confirm that it isn't a temporal error value. If the data is normal, it is reusable. However, if it's continually removed, there is a possibility that correct data is not received from sensor. In this case, contact FURUNO.</p>	Caution/B
30500,15	875	<p>Name: Gyro 5 Sensor Banned</p> <p>Meaning: Heading data from No.5 Gyro is determined abnormal by integrity check.</p> <p>Remedy: Reset the filter to confirm that it isn't a temporal error value. If the data is normal, it is reusable. However, if it's continually removed, there is a possibility that correct data is not received from sensor. In this case, contact FURUNO.</p>	Caution/B
30500,21	861	<p>Name: SDME 1 Sensor Banned</p> <p>Meaning: Own ship speed data from No.1 SDME is determined abnormal by integrity check.</p> <p>Remedy: Reset the filter to confirm that it isn't a temporal error value. If the data is normal, it is reusable. However, if it's continually removed, there is a possibility that correct data is not received from sensor. In this case, contact FURUNO.</p>	Caution/B
30500,22	862	<p>Name: SDME 2 Sensor Banned</p> <p>Meaning: Own ship speed data from No.2 SDME is determined abnormal by integrity check.</p> <p>Remedy: Reset the filter to confirm that it isn't a temporal error value. If the data is normal, it is reusable. However, if it's continually removed, there is a possibility that correct data is not received from sensor. In this case, contact FURUNO.</p>	Caution/B
30500,23	863	<p>Name: SDME 3 Sensor Banned</p> <p>Meaning: Own ship speed data from No.3 SDME is determined abnormal by integrity check.</p> <p>Remedy: Reset the filter to confirm that it isn't a temporal error value. If the data is normal, it is reusable. However, if it's continually removed, there is a possibility that correct data is not received from sensor. In this case, contact FURUNO.</p>	Caution/B

APPX. 4 ALERT LIST

Alert No.		Alert Name, Meaning and Remedy	Priority/Category
ALF	ALR		
30500,31	881	<p>Name: ROT Gyro 1 Sensor Banned</p> <p>Meaning: Heading data from No.1 ROT Gyro is determined abnormal by integrity check.</p> <p>Remedy: Reset the filter to confirm that it isn't a temporal error value. If the data is normal, it is reusable. However, if it's continually removed, there is a possibility that correct data is not received from sensor. In this case, contact FURUNO.</p>	Caution/B
30500,32	882	<p>Name: ROT Gyro 2 Sensor Banned</p> <p>Meaning: Heading data from No.2 ROT Gyro is determined abnormal by integrity check.</p> <p>Remedy: Reset the filter to confirm that it isn't a temporal error value. If the data is normal, it is reusable. However, if it's continually removed, there is a possibility that correct data is not received from sensor. In this case, contact FURUNO.</p>	Caution/B
30500,33	883	<p>Name: ROT Gyro 3 Sensor Banned</p> <p>Meaning: Heading data from No.3 ROT Gyro is determined abnormal by integrity check.</p> <p>Remedy: Reset the filter to confirm that it isn't a temporal error value. If the data is normal, it is reusable. However, if it's continually removed, there is a possibility that correct data is not received from sensor. In this case, contact FURUNO.</p>	Caution/B
30510,1	900	<p>Name: No Filter Source of Position*</p> <p>Meaning: No valid position sensor is available for filter. (Banned or connection error)</p> <p>Remedy: Reset the filter to confirm that it isn't a temporal error value. If the data is normal, it is reusable. However, if it's continually removed, there is a possibility that correct data is not received from sensor. Also, check the status of, and connection, with GPS. If the problem cannot be resolved, contact FURUNO.</p>	Warning/B
30510,2	901	<p>Name: No Filter Source of COG/SOG*</p> <p>Meaning: No valid COG/SOG sensor is available for filter. (Banned or connection error)</p> <p>Remedy: Reset the filter to confirm that it isn't a temporal error value. If the data is normal, it is reusable. However, if it's continually removed, there is a possibility that correct data is not received from sensor. Also, check the status of, and connection, with GPS. If the problem cannot be resolved, contact FURUNO.</p>	Warning/B
30510,3	902	<p>Name: No Filter Source of CTW/STW*</p> <p>Meaning: No valid CTW/STW sensor is available for filter. (Banned or connection error)</p> <p>Remedy: Reset the filter to confirm that it isn't a temporal error value. If the data is normal, it is reusable. However, if it's continually removed, there is a possibility that correct data is not received from sensor. Also, check the status of, and connection, with SDME sensors. If the problem cannot be resolved, contact FURUNO.</p>	Warning/B

Alert No.		Alert Name, Meaning and Remedy	Priority/ Category
ALF	ALR		
30510,4	903	<p>Name: No Filter Source of Heading*</p> <p>Meaning: No valid heading sensor is available for filter. (Banned or connection error)</p> <p>Remedy: Reset the filter to confirm that it isn't a temporal error value. If the data is normal, it is reusable. However, if it's continually removed, there is a possibility that correct data is not received from sensor. Also, check the status of, and connection, with heading sensors. If the problem cannot be resolved, contact FURUNO.</p>	Warning/B
30510,5	904	<p>Name: No Filter Source of ROT*</p> <p>Meaning: No valid position sensor is available for filter. (Banned or connection error)</p> <p>Remedy: Reset the filter to confirm that it isn't a temporal error value. If the data is normal, it is reusable. However, if it's continually removed, there is a possibility that correct data is not received from sensor. Also, check the status of, and connection, with heading sensors. If the problem cannot be resolved, contact FURUNO.</p>	Warning/B
30601,1	272	<p>Name: UTC Time Not Available*</p> <p>Meaning: Time data of all available GPS sensor has been not available for more than 3 seconds.</p> <p>Remedy: Check the connection with all GPS. Also, check sensor status.</p>	Caution/B
30601,2	277	<p>Name: Wind Speed/Direction Not Available*</p> <p>Meaning: Wind speed/direction data of all available WIND sensors has been not available for more than 3 seconds.</p> <p>Remedy: Check the connection with all wind sensors. Also, check sensor status.</p>	Caution/B
30601,3	279	<p>Name: COG/SOG Not Available*</p> <p>Meaning: COG/SOG data of all available GPS sensor has been not available for more than 3 seconds.</p> <p>Remedy: Check the connection with all GPS. Also, check sensor status.</p>	Caution/B
30601,4	284	<p>Name: SOG Not Available*</p> <p>Meaning: There is no SOG sensor data or the SOG sentence is invalid.</p> <p>Remedy: Check that the sensor is powered. Also, check sensor status.</p>	Caution/B
30601,5	450	<p>Name: Heading Sensor Not Available*</p> <p>Meaning: Heading data of all available gyro has been not available for more than 2 seconds.</p> <p>Remedy: Check the connection with all gyro. Also, check sensor status.</p>	Caution/B
30601,6	453	<p>Name: SDME Sensor Not Available*</p> <p>Meaning: Speed data from all available SDME has been not available for more than 3 seconds.</p> <p>Remedy: Check the connection with all SDME. Also, check sensor status.</p>	Caution/B
30602,1	472	<p>Name: Position Source Change</p> <p>Meaning: Position sensor used in system (distributed by own ship's information management) is changed.</p> <p>Remedy: -</p>	Caution/B

APPX. 4 ALERT LIST

Alert No.		Alert Name, Meaning and Remedy	Priority/Category
ALF	ALR		
30602,2	473	Name: Heading Source Change Meaning: Heading sensor used in system (distributed by own ship's information management) is changed. Remedy: -	Caution/B
30602,3	474	Name: COG/SOG Source Change Meaning: COG/SOG sensor used in system (distributed by own ship's information management) is changed. Remedy: -	Caution/B
30602,4	475	Name: CTW/STW Source Change Meaning: CTW/STW sensor used in system (distributed by own ship's information management) is changed. Remedy: -	Caution/B
30602,5	470	Name: Datum Change Meaning: Current datum of EPSF is changed. Acquisition timing: Once in 60 seconds or when position sensor used in system (distributed by own ship's information management) is changed. Remedy: Check the operator's manual of GPS.	Caution/B
30603,1	273	Name: Depth(Bow) Not Available Meaning: Depth data of all available depth sensor(Bow) has been not available for more than 3 seconds. Remedy: Check the connection with all echo sounders.	Caution/B
30603,2	274	Name: Depth(Mid) Not Available Meaning: Depth data of all available depth sensor(Mid) has been not available for more than 3 seconds. Remedy: Check the connection with all echo sounders.	Caution/B
30603,3	275	Name: Depth(Stern) Not Available Meaning: Depth data of all available depth sensor(Stern) has been not available for more than 3 seconds. Remedy: Check the connection with all echo sounders.	Caution/B
30603,4	278	Name: STW Not Available Meaning: STW data of all available SDME sensors has been not available for more than 3 seconds. Remedy: Check the connection with all SDME.	Caution/B
30603,5	285	Name: Heading Magnetic Not Available Meaning: Heading data of all available magnetic gyro has been not available for more than 3 seconds. Remedy: Check the connection with all magnetic gyro.	Caution/B
30644,-	644	Name: Actual UKC Limit* Meaning: Actual depth is outside the preset UKC limit. Remedy: Check depth, adjust heading accordingly.	Warning/A
30700,-	700	Name: RT Version is higher Meaning: Received route transfer sentence (RTZ) is a higher version than this system. Remedy: Check route details. Some route details may not be displayed correctly.	Caution/B
30702,-	528	Name: REF Target Lost* Meaning: REF target is lost and cannot be tracked. Remedy: REF target is lost. Check the lost target.	Warning/A

Alert No.		Alert Name, Meaning and Remedy	Priority/ Category
ALF	ALR		
30711,-	539	Name: AIS Message Received Meaning: AIS message is received. Remedy: -	Caution/B
30712,-	541	Name: AIS Message Transmit Error Meaning: AIS message transmission failed. Remedy: Check the connection with AIS.	Caution/B
30713,-	542	Name: AIS Transmitting Meaning: AIS transponder is transmitting. Remedy: -	Caution/B
30715,-	550	Name: Active AIS-SART/MOB/EPIRB* Meaning: Detected an active AIS-SART, MOB or EPIRB. Remedy: Take the appropriate action.	Warning/B
30800,1	691	Name: RM Stop - Exceed Max XTD Meaning: Route monitoring is stopped because distance from route is more than set value of Max XTD. Remedy: Start route monitoring after approaching the monitoring route.	Alarm/A
30800,2	692	Name: RM Stop - Sensor lost Meaning: Error occurs inside of route monitoring function. Remedy: If the error frequently occurs, contact FURUNO and inform frequency of occurrence.	Alarm/A
30800,3	693	Name: RM Stop - Internal Error Meaning: Required data for route monitoring such as position, SOG/COG cannot be acquired. Remedy: Check the connection with GYRO, GPS and SDME.	Alarm/A
30801,-	485	Name: Depth Limit Meaning: Seabed has been less than set depth for more than 3 seconds. Remedy: Be careful of risk of grounding.	Alarm/A
30802,-	495	Name: Anchor Watch** Meaning: While anchor watch alert function is enabled, ship's position has been outside of alarm area centering certain position for more than 3 seconds. Remedy: Be careful of dragging anchor.	Warning/A
30803,-	640	Name: Chartalign: Over 30 min Meaning: Own ship position has been offset for more than 30 minutes. Remedy: Reset offset.	Caution/B
30807,-	820	Name: NAVTEX Message Received Meaning: NAVTEX message is received. Remedy: -	Caution/B
30850,-	652	Name: End of track* Meaning: Ship will reach last waypoint in 30 seconds. Remedy: Be careful that last waypoint is approaching.	Warning/A
30855,-	695	Name: Position Monitor Meaning: When position data is input from two or more GPS, there is a difference between the position data from each GPS. Remedy: Check an accurate position data source, GPS reception status and GPS settings.	Caution/B

APPX. 4 ALERT LIST

Alert No.		Alert Name, Meaning and Remedy	Priority/ Category
ALF	ALR		
30860,1	645	Name: Navigational Hazard* Meaning: One or more navigational hazard detected by the Look-ahead function. Remedy: Adjust course as necessary.	Warning/A

**SPECIFICATIONS OF
Electronic Chart Display and Information System (ECDIS)
FMD-3100**

1 PANEL COMPUTER UNIT

1.1	Display type	24-inch color LCD, 1,920 x 1,080 pixel (Full-HD)
1.2	Brilliance	300 cd/m ² typical
1.3	Viewable distance	0.952 m nominal
1.4	Display mode	HU (RM)/NU (TM/RM)/CU (TM/RM)/RU (RM)
1.5	Chart materials	IMO/IHO S57/S63 ENC or C-MAP vectorized material BA ARCS rasterized material
1.6	Own ship's indication	Own ship's mark/track and numeral position in lat/lon, speed, course and heading
1.7	Target tracking (TT)	Range, bearing, speed, course, CPA/TCPA Target information from AIS
1.8	Other information	Route information, Waypoint, Route monitoring and several alarms
1.9	Display features	Chart zoom-in/out, Cursor (EBL, VRM, parallel index lines), Scroll, Symbol select, Palette select, One touch activation, Electronic chart information auto-update
1.10	Position calculation	Navigation by result of positioning found with external sensor Dead reckoning with gyro and log Highly accurate position, speed and heading from Kalman filter
1.11	Route planning	Planning by rhumb line, great circle, Chart alarm, Route creation, SAR composition, Optimize
1.12	Route monitoring	Off-track display, Waypoint arrival alarm, Shallow depth alarm, Route data is transferred to radar
1.13	User chart creation	1500 points max. (300 points x 5 files)
1.14	Notes	Create and display notes data; transferred to radar
1.15	AIS safety message	Receive, create and transmit safety messages View and modify own ship information stored in AIS transponder
1.16	NAVTEX message	Receive and display NAVTEX messages (position, etc.)
1.17	MOB (Man Overboard)	Position and other data at time of man overboard are recorded MOB mark is displayed on the screen
1.18	Manual update	User enters, deletes and edits chart objects
1.19	Other functions	Radar overlay, Playback voyage data

2 INTELLIGENT HUB (OPTION)

2.1	Number of ports	8 ports (10/100/1000BASE-T)
2.2	Switching method	Store and forward, non-blocking L2 switching
2.3	Capacitance of switching	16 Gbps
2.4	Flow Control	Full-Duplex (IEEE802.3x flow-controlled at automatic mode)
2.5	Ring aggregation	8 group max.
2.6	Spanning tree	STP(IEEE802.1D), RSTP(IEEE802.1w), MST(IEEE802.1s)
2.7	IGMP snooping	IGMP v1, v2, v3
2.8	Operation control	PING, SNMP v1, v2c, v3

- 2.9 VLAN Port-base VLAN, IEEE802.1Q Tag VLAN supported, VLAN ID: 1 to 4094, VLAN registration: 128 group
- 2.10 Multiple VLAN Communication between isolated ports is disabled
- 2.11 Cast control Broadcast, Multicast suppression

3 RADAR OVERLAY (OPTION)

- 3.1 Picture color Radar picture: 256 colors
- 3.2 Range 0.125 to 96 NM
- 3.3 Display mode Heading-up, North-up (heading data required)
- 3.4 Other functions Off-center, Echo trail, Interference rejection, Anchor watch

4 INTERFACE

4.1 Panel Computer Unit (PCU-3000)

- Serial I/O 4 ports (IEC61162-1/2: 2 ports, IEC61162-1: 2 ports)
- Data sentences (IEC61162-1/2)
 - Input ABK, ACN, ALC, ALF, ALR, ARC, CUR, DBT, DPT, DTM, ETL, GGA, GLL, GNS, HBT, HCR, HDT, MTW, MWV, NRM, NRX, NSR, OSD, PRC, RMC, ROR, ROT, RPM, RRT, RSA, THS, TLB, TRC, TRD, TTD, TTM, VBW, VDM, VDO, VDR, VHW, VLW, VSD, VTG, XDR, ZDA
 - Output ABM, ACK, ACN, ALC, ALF, ALR, ARC, BBM, DDC, EVE, HBT, OSD, RRT, RTE, VBW, VDR, VSD, WPL, XTE
 - DVI output 2 ports: DVI-D (DVI1), DVI-I or RGB (DVI2)
Note: Full HD monitor required
 - LAN 1 port: Ethernet, 1000Base-T (for local communication)
 - USB 4 ports (1 port for control unit), USB2.0 (type-A)

4.2 Sensor adapter (option)

- MC-3000S (serial) 8 ports: I/O, IEC61162-1/2: 4 ports, IEC61162-1: 4 ports
- MC-3020D (digital-in) 8 ports: relay contact, logics set from program
- MC-3030D (digital-out) 8 ports: relay contact, normal open and normal close available

4.3 IEC61162-450 (PCU-3000)

- Port (LAN2) 1000Base-T, IPv4, 8P8C connector
- Data sentences
 - Input ABK, ACN, ALC, ALF, ALR, ARC, CUR, DBT, DPT, DTM, ETL, GGA, GLL, GNS, HBT, HCR, HDT, MTW, MWV, NRM, NRX, NSR, OSD, PRC, RMC, ROR, ROT, RPM, RRT, RSA, THS, TLB, TRC, TRD, TTD, TTM, VBW, VDM, VDO, VDR, VHW, VLW, VSD, VTG, XDR, ZDA
 - Output ABM, ACK, ACN, ALC, ALF, ALR, ARC, BBM, DDC, EVE, HBT, OSD, RRT, RTE, VBW, VDR, VSD, WPL, XTE
- IEC61162-450 transmission group
 - Data sentences
 - Input MISC, TGTD, SATD, NAVD, VDRD, RCOM, TIME, PROP, USR1 to USR8
 - Output Arbitrary (default: TGTD)
 - Multicast address 239.192.0.1 to 239.192.0.16

- Destination port 60001 to 60016
- Re-transmittable binary image transfer
 - Multicast address 239.192.0.26 to 239.192.0.30
 - Destination port 60026 to 60030
- Other Network function excepted IEC61162-450
 - HTTP: *.*.*.:80, XML-RPC: *.*.*.:6403
 - Syslog: 239.192.0.254:514
- 4.4 IEC61162-450 (MC-3000S)
 - Port 100Base-TX, IPv4, 8P8C connector
 - Maximum data rate 800 sps
 - Data sentence Output: XDR
 - IEC61162-450 transmission group
 - Input MISC, TGTD, SATD, NAVD, VDRD, RCOM, TIME, PROP, USR1 to USR8
 - Output Arbitrary (default: MISC)
 - Multicast address 239.192.0.1 to 239.192.0.16
 - Destination port 60001 to 60016
 - Other Network function excepted IEC61162-450
 - HTTP: *.*.*.:80, XML-RPC: *.*.*.:6403
 - Syslog: 239.192.0.254:514
- 5 POWER SUPPLY**
 - 5.1 Panel Computer unit 100-230 VAC: 0.7-0.4 A, 1 phase, 50/60 Hz or 24 VDC: 3.0 A
 - 5.2 Sensor adapter (option) 24 VDC: 1.4 A (for 11 units), Input to MC-3000S, the sources of other sensor adapters are fed from MC-3000S
 - 5.3 Radar connection box (option) 24 VDC: 0.6 A
 - 5.4 HUB (HUB-3000, HUB-100, option) 100-230 VAC: 0.1 A, 1 phase, 50-60 Hz
- 6 ENVIRONMENTAL CONDITION**
 - 6.1 Ambient temperature -15°C to +55°C
 - 6.2 Relative humidity 93% or less at +40°C
 - 6.3 Degree of protection
 - Panel computer unit IP65 (panel), IP22 (chassis)
 - Control unit/ Radar connection box/ Intelligent HUB (HUB-3000) IP22
 - Sensor adapter IP20
 - Switching HUB (HUB-100) IPX0
 - 6.4 Vibration IEC 60945 Ed.4
- 7 UNIT COLOR**
 - 7.1 Panel computer unit N2.5 (fixed)
 - 7.2 Sensor adapter N2.5
 - 7.3 Radar connection box N2.5
 - 7.4 HUB N2.5 (HUB-3000), N3.0 (HUB-100)

INDEX

A

Abbreviations	AP-5
Aggregated alerts	20-5
AIO	
chart cells	5-10
chart object information	5-10
displaying	5-9
information to display	5-11
information to display (S57)	7-4
AIS	
automatic activation of sleeping targets	14-8
deleting received and sent	
safety messages	15-3
filtering targets	14-7
own ship data	14-13
past positions	14-12
received and sent safety messages	15-2
sending safety messages	15-1
showing, hiding targets	14-6
sleeping target	14-8
symbols	14-2
target data	14-9, 14-10
Vector length	14-11
voyage data	14-5
Alert box	2-13, 20-2
Alert list	20-7
Alert log	20-9
Alert parameters page	9-9
Alert setting	22-5
Alert setting page	22-5
Alerts	
acknowledging	20-6
aggregation	20-5
alert list	20-7, AP-17
alert log	20-9
alert state icons	20-4
buzzer silencing	20-6
definition	20-1
list of	AP-17
message format	20-3
Anchor watch	12-8
ARCS charts	
catalog of chart cells	3-18
chart cell grouping	3-20
chart installation	3-7
chart legend	6-1
datum	6-5
deleting	3-25
details	6-2
export list of	3-14
install/update history	3-17
license backup	3-15
license deletion	3-9
license display	3-15

license installation	3-6
license installation, automatic	3-6
license restoring	3-15
notes	6-4
permanent warnings	6-5
permit status	3-16
preferences for inset	6-3
SDD	6-4
subscriptions	6-6
T&P notices	6-2
warnings	6-3
Area report	10-15

B

Basic setting page	4-3
Brilliance	1-5
Buzzer stop button	20-4

C

CCRP page	22-15
CCRS	18-1
Chart alerts	
introduction	8-1
objects used in	8-3
own ship check	8-4
route planning	8-5
Chart cells	
AIO	5-10
catalog of	3-18
deleting	3-21
editing	3-21
grouping	3-20
status	3-21
Chart database button	4-12
Chart legend	
C-MAP	7-2
S57 (ENC)	5-2
Chart scale	2-18
Chart synchronization	
select units to synchronize	3-31
synchronization status	3-31
Chart usage log	19-8
Charts	
cell deleting	3-21
cell editing	3-21
Check area page	8-4, 12-5
Check results page	9-10
Circle report	10-15
Clearing line report	10-14
C-MAP charts	
cartographic services	7-1
catalog of chart cells	3-18
chart cell grouping	3-20
chart cell status	3-22
chart legend	7-2

- database deletion 3-14
- database installation 3-11
- eToken registration 3-10
- export list of 3-14
- install/update history 3-17
- installing from CD ROM..... 3-7
- license installation 3-12
- license status confirmation 3-14
- opening 3-22
- permit status..... 3-16
- update file, applying 3-14
- update file, generating, ordering 3-13
- COG/SOG page 18-3
- Color differentiation test
(S57 ENC charts) 23-5
- Consummable parts 23-4
- Context-sensitive menus 2-14
- Cost parameters 21-3
- Cursor position box 2-20
- Customize page 22-9
- D**
- Danger targets log
 - viewing 19-9
- Data sharing 22-8
- Deep contour 4-1
- Depth sensor 18-14
- Details log 19-5
- Display date 5-4
- Display test page..... 22-10
- Divider
 - activating 12-12
 - characteristics 12-13
 - deactivating 12-13
 - limitations 12-13
 - procedure 12-12
- DVD drive 1-3
- E**
- EBL
 - bearing reference 2-23
 - context-sensitive menu 2-24
 - measuring bearing with 2-23
 - showing 2-23
- EBL, VRM boxes 2-13
- ECDIS modes 2-17
- ECDIS system information 1-16
- Echo page 16-2
- ENC charts
 - AIO display 5-9
 - catalog of chart cells 3-18
 - chart cell grouping 3-20
 - chart cell status 3-22
 - chart installation 3-4
 - chart legend 5-2
 - clearing 3-35
 - color differentiation test 23-5
 - deleting 3-25
 - ENC coverage indication 3-26
 - ENC list export 3-15
 - ENC permit display..... 3-15
 - export list of 3-14
 - install/update history..... 3-17
 - installing from medium 3-7
 - license backup 3-15
 - license deletion 3-9
 - license installation, automatic..... 3-3
 - license installation, manual 3-3
 - license restore 3-16
 - manual updates..... 3-26
 - opening 3-22
 - permanent warnings..... 5-3
 - permit status..... 3-16
 - presentation library..... 5-7
 - publishers notes 3-25
 - reconverting 3-33
 - symbols used in..... 5-7
- F**
- File import page 22-3
- File maintenance page 22-4
- Filter status..... 18-9
- Forwarding distances 21-2
- Full user chart report 10-13
- Full WPT report 9-29
- G**
- Gate-1
 - chart installation 3-34
 - chart selection (for installation)..... 3-33
 - license installation 3-34
- General page 4-6
- H**
- Heading input 1-10
- I**
- Instant access bar 2-7
- Instant track
 - back to track 11-9
 - button label..... 11-15
 - details 11-12
 - messages 11-11
 - monitoring 11-12
 - parameters 21-4
 - returning to monitored route 11-14
 - safe off track..... 11-8
 - stopping monitoring 11-13
- J**
- Jeppesen charts
 - chart cell status 3-22
- K**
- Keyboard test 22-11
- L**
- Label report 10-15
- Line report 10-14
- Log playback 19-12
- M**
- Maintenance 23-1

INDEX

- Manual updates
 - deleting update symbols3-28
 - inserting new update symbols3-27
 - modifying existing update symbols3-29
- Mariner page4-10
- Menu treeAP-1
- Mini conning display12-11
- MOB button1-11
- MOB position1-11
- N**
- Navigation data18-7
- Navtex
 - deleting messages15-5
 - receiving messages15-4
- O**
- Odometer resetting2-33
- Operator's manual1-16
- Optimize page9-8, 9-18
- Other sensors page18-4
- Overlay/NAV Tools box
 - anchor watch12-8
 - check area page12-5
 - PI (parallel index) page12-1
 - predictor12-7
 - ring12-5
 - UKC12-9
- Overlay/Nav Tools box2-13
- Own ship functions box2-11
- P**
- Palette (color)1-4
- Palette button1-4
- Panel Computer Unit1-1
- Parallel index lines
 - activating, deactivating12-2
 - bearing reference12-2
 - interval12-3
 - length adjustment12-4
 - mode12-2
 - number of lines to display12-2
 - orientation12-3
 - resetting12-3
- Passage plan report9-30
- Permanent warning box2-13
- Permanent warnings
 - ARCS charts6-5
 - ENC charts5-3
- Permit status3-16
- PI (parallel index) page12-1
- Play back log19-12
- Position
 - alignment18-11
 - primary and secondary18-6
 - source18-5
- Position events19-2
- POSN page18-4
- Power switch1-3
- Predictor12-7
- Presentation library5-7
- Presentation mode2-19
- Printing
 - cell status list3-24
 - chart list3-23
- Public key (ENC charts)3-2
- Publishers notes3-25
- R**
- Radar overlay
 - adjusting overlay fed via RCB16-3
 - errors in16-7, 16-8
 - introduction16-1
 - setting up16-2
- RCB page (radar overly setup)16-3
- Recording
 - chart usage log19-8
 - danger targets log19-9
 - details log19-5
 - user events19-1
 - voyage log19-6
- Reports
 - area10-15
 - circle10-15
 - clearing line10-14
 - full user chart10-13
 - Full WPT9-29
 - label10-15
 - passage plan9-30
 - tidal10-13
 - WPT table9-28
- Ring page12-5
- Route bank9-16
- Route information box2-12
- Route page4-9
- Route transfer log19-10
- Routes
 - adding waypoints at end of route9-11
 - changing waypoint position9-11
 - creating new9-3
 - deleting9-23
 - deleting waypoints9-12
 - exporting9-22
 - exporting in FEA-2x07, csv, ASCII format9-23
 - full WPT report9-29
 - importing csv, ASCII data9-21
 - importing FEA-2x07 data9-21
 - importing FMD-3xx0, FCR-2xx9 data9-20
 - inserting waypoint9-12
 - optimizing9-18
 - overview in planning9-1
 - passage plan report9-30
 - route bank9-16
 - SAR9-14
 - selecting for monitoring11-1
 - selecting route components to display11-4
 - stopping monitoring11-4
 - switching monitored to planning11-7

- syncing 9-2
- user chart information in route
 - monitoring 11-6
 - user chart page (route planning) 9-7
 - Waypoints page (monitoring) 11-5
 - waypoints page (route planning) 9-6
 - WPT table 9-28
- S**
- S57 charts
 - chart object information 5-8
- Safety contour 4-1, 8-2
- Safety depth 4-1
- SAR route 9-14
- Screenshots
 - capturing 1-12
 - deleting 22-13
 - exporting 22-13
 - printing 22-13
- Screenshots page 22-12
- Sensor information box 2-10
- Sensor set (system, local) 1-7
- Sensors menu 18-2
- Settings menu 1-13
 - accessing 22-1
 - CCRP 22-15
 - customize page 22-9
 - display test page 22-10
 - file export page 22-2
 - file import page 22-3
 - file maintenance page 22-4
 - keyboard test page 22-11
 - screenshots page 22-12
 - self test page 22-7
 - user default page 22-14
- Shallow contour 4-1
- Ship and route parameters 21-1
- SPD page 18-2
- Speed input 1-8
- Split screen 1-17
- Standard page 4-4
- Status bar 2-5
- Symbols (ECDIS) AP-8
- T**
- T&P notices 6-2
- Targets page 4-11
- Tidal report 10-13
- Time 1-12
- Tips 1-17
- Trackball control unit 1-3
- Trackball maintenance 23-2
- Tracking page 4-7
- trip meter resetting 2-33
- Troubleshooting 23-3
- True motion reset 2-21
- TT
 - past positions, attributes 13-7
 - past positions, plot interval, reference... 13-7
 - showing, hiding 13-1
 - symbol color 13-2
 - symbol size 13-2
 - symbols and their attributes 13-2
 - target data 13-6
 - vector length 13-4
- TT filter 13-3
- U**
- UKC page
 - setting 12-9
 - UKC window 12-10
- UKC window 12-10
- Undo 9-5, 10-6
- User chart page
 - route monitoring 11-6
 - route planning 9-7
- User charts
 - area report 10-15
 - circle report 10-15
 - clearing line report 10-14
 - creating 10-3
 - deleting 10-12
 - deleting objects from 10-8
 - editing objects on 10-7
 - full report 10-13
 - importing 10-9, 10-10
 - information in route monitoring 11-6
 - line report 10-14
 - notes 10-5
 - object information 11-7
 - route monitoring 10-16
 - selecting objects to display 10-9
 - syncing 10-2
 - tidal report 10-13
- User default page 22-14
- User events 19-1
- User profile 1-13
- V**
- Vector length
 - AIS 14-11
 - TT 13-4
- Voyage log 19-7
- VRM
 - hiding 2-23
 - measuring range with 2-23
- W**
- Waypoints page
 - route monitoring 11-5
 - route planning 9-6
- Weather overlay
 - activating 17-1
 - cloud coverage display 17-6
 - deactivating 17-2
 - file playback 17-2
 - file selection 17-2
 - ocean current display 17-7
 - operability 17-8

INDEX

precipitation rate display	17-6
setup	17-3
temperature display.....	17-6
viewability.....	17-8
waves display.....	17-7
Weather Overlay Control dialog box	17-2
Weather Overlay dialog box.....	17-2
weather spot information.....	17-8
wind display.....	17-5
Wind sensor	18-12
WPT table report.....	9-28, 9-29, 9-30

Declaration of Conformity



0560

We **FURUNO ELECTRIC CO., LTD.**

(Manufacturer)

9-52 Ashihara-Cho, Nishinomiya City, 662-8580, Hyogo, Japan

(Address)

declare under our sole responsibility that the product

**ELECTRONIC CHART DISPLAY AND INFORMATION SYSTEM
FMD-3100**

(Serial No.1000-13xx-xxxx)

(Model name, type number)

to which this declaration relates conforms to the following standard(s) or normative document(s)

IMO Resolution A.694(17)	IEC 61174 Ed. 4.0: 2015
IMO Resolution MSC.36(63)	IEC 61162-1 Ed.5.0: 2016
IMO Resolution MSC.97(73)	IEC 61162-2 Ed. 1.0: 1998
IMO Resolution MSC.191(79)	IEC 61162-450 Ed.1.0 A1: 2016
IMO Resolution MSC.232(82)	IEC 62288 Ed. 2.0: 2014
IMO Resolution MSC.302(87)	IEC 60945 Ed. 4.0: 2002 incl. Corr. 1, 2008
IMO MSC.1/Circ.1503	IEC 61996-1 Ed. 2.0: 2013 Annex G

(title and/or number and date of issue of the standard(s) or other normative document(s))

For assessment, see

- EC Type Examination (Module B) certificate No.MEDB00001MN Rev.2 issued by DNV GL AS (0575), Norway.
- Product Quality System (Module D) certificate No. P 112 (Issue 46) issued by Telefication, The Netherlands.

This declaration is issued according to the Directive 2014/90/EU of the European Parliament and of the Council on marine equipment, and the Implementing Regulation (EU) 2019/1397.

On behalf of Furuno Electric Co., Ltd.

Nishinomiya City, Japan
July 29, 2020

(Place and date of issue)

Yoshitaka Shogaki
Department General Manager
Quality Assurance Department

(name and signature or equivalent marking of authorized person)