

FURUNO

OPERATOR'S MANUAL

AUTOPILOT

Model **NAVpilot-300**

 FURUNO ELECTRIC CO., LTD.



www.furuno.com

FURUNO ELECTRIC CO., LTD.

9-52 Ashihara-cho,
Nishinomiya, 662-8580, JAPAN

• FURUNO Authorized Distributor/Dealer

All rights reserved. Printed in Japan

Pub. No. OME-72840-E2

(YOTA) NAVpilot-300

A : OCT. 2017
E2 : OCT. 25, 2022



0 0 0 1 9 3 2 9 4 1 4

IMPORTANT NOTICES

General

- This manual has been authored with simplified grammar, to meet the needs of international users.
- The operator of this equipment must read and follow the instructions in this manual. Wrong operation or maintenance can void the warranty or cause injury.
- Do not copy any part of this manual without written permission from FURUNO.
- If this manual is lost or worn, contact your dealer about replacement.
- The contents of this manual and the equipment specifications can change without notice.
- The example screens (or illustrations) shown in this manual can be different from the screens you see on your display. The screens you see depend on your system configuration and equipment settings.
- Save this manual for future reference.
- Any modification of the equipment (including software) by persons not authorized by FURUNO will void the warranty.
- The following concern acts as our importer in Europe, as defined in DECISION No 768/2008/EC.
 - Name: FURUNO EUROPE B.V.
 - Address: Siriusstraat 86, 5015 BT, Tilburg, The Netherlands
- The following concern acts as our importer in UK, as defined in SI 2016/1025 as amended SI 2019/470.
 - Name: FURUNO (UK) LTD.
 - Address: West Building Penner Road Havant Hampshire PO9 1QY, U.K.
- All brand, product names, trademarks, registered trademarks, and service marks belong to their respective holders.
- The Bluetooth® word mark and logos are registered trademarks owned by Bluetooth SIG, Inc.

IC Approved Bluetooth®

8595A-ANNAB1

How to discard this product

Discard this product according to local regulations for the disposal of industrial waste. For disposal in the USA, see the homepage of the Electronics Industries Alliance (<http://www.eiae.org/>) for the correct method of disposal.

How to discard a used battery

Some FURUNO products have a battery(ies). To see if your product has a battery, see the chapter on Maintenance. Follow the instructions below if a battery is used. Tape the + and - terminals of battery before disposal to prevent fire, heat generation caused by short circuit.

In the European Union

The crossed-out trash can symbol indicates that all types of batteries must not be discarded in standard trash, or at a trash site. Take the used batteries to a battery collection site according to your national legislation and the Batteries Directive 2006/66/EU.

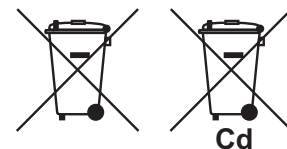

In the USA

The Mobius loop symbol (three chasing arrows) indicates that Ni-Cd and lead-acid rechargeable batteries must be recycled. Take the used batteries to a battery collection site according to local laws.

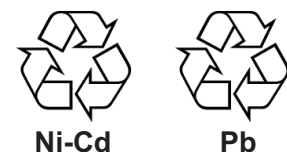



In the other countries

There are no international standards for the battery recycle symbol. The number of symbols can increase when the other countries make their own recycle symbols in the future.













SAFETY INSTRUCTIONS





Please read these safety instructions before you operate the equipment.



 WARNING	Indicates a condition that can cause death or serious injury if not avoided.
 CAUTION	Indicates a condition that can cause minor or moderate injury if not avoided.

 Warning, Caution	 Prohibitive Action	 Mandatory Action
--	--	--

 WARNING	
	Do not disassemble or modify the equipment. Fire or electrical shock can result if the equipment is modified.
	Turn off the power immediately if water leaks into the equipment or the equipment is emitting smoke or fire. Continued use of the equipment can cause fire or electrical shock.
	Do not set the course changing speed too high. The boat will be turned too sharply at the course change, which could create a very dangerous situation.
	Do not use the autopilot in the following situations: <ul style="list-style-type: none"> - Own ship speed is over 40 knots - When navigating narrow channels - When entering/leaving the harbor - When navigating areas with heavy traffic - When navigating areas with a narrow view, affected by fog/mist/rain - When moored

 WARNING	
	Observe the following cautions when using the autopilot: <ul style="list-style-type: none"> - Maintain a vigilant watch - Watch for drifting of vessel
	Do not use the SIMULATION mode on the boat. The rudder may move suddenly. This is a special-purpose mode for technicians.
	Do not use the ORBIT turn in rough seas. Because the boat turns a 360° circle around the waypoint, a large wave or strong wind can cause the boat to capsize.
	For the figure-eight mode, confirm that no object is in the general vicinity of the waypoint. The distance from the waypoint to the turning point depends on boat's speed.
	Use the correct fuse. Use of a wrong fuse can cause fire or damage the equipment.

 CAUTION	
	<p>Do not apply force excessive force or shock to the LCD panel.</p> <p>Force or shock can damaged the LCD or cause equipment failure</p>
	<p>In case of power failure, turn off the autopilot or manually steer the vessel.</p> <p>Leaving the equipment in the AUTO or NAV mode during power failure will cause wear on the rudder mechanism.</p>
	<p>Keep the following points in mind when using Fantum Feedback™.</p> <p>The autopilot cannot detect the rudder position when using Fantum Feedback™. Therefore, over-steering after reaching rudder limit can occur. If over-steering continues, the drive unit may malfunction, preventing automatic steering. To prevent over-steering, keep the following points in mind.</p> <ul style="list-style-type: none"> - Use the autopilot within the speed at which the autopilot can control the vessel. Pay particular attention when keeping the stern facing windward (or into the current) in the SABIKI mode. - Always check the rudder position to stop the rudder with the autopilot before reaching the rudder limit. - When the rudder reaches rudder limit, the drive unit is temporarily disabled and the autopilot cannot move the rudder. If this occurs, the deviation alarm (see section 3.5) sounds regardless of the setting value. In this case, switch to the STBY mode and turn the helm to move the rudder.

 CAUTION	
	<p>Only use the specified battery. When replacing the battery, make sure the polarity is correct.</p> <p>Incorrect placement of the battery can cause the battery to explode or damage the equipment.</p>
	<p>Do not use high-pressure cleaners to clean this equipment.</p> <p>This equipment has the waterproof rating outlined in the specifications, at the back of this manual. However, the use of high-pressure cleaning equipment can cause water ingress, resulting in damage to, or failure of, the equipment.</p>

Caution Label(s)

Caution label(s) is(are) attached to the equipment. Do not remove the label(s). If a label is missing or damaged, contact a FURUNO agent or dealer about replacement.

**Do not remove cover.
No user-serviceable parts inside.**

サービスマン以外の方はカバーを開けないで下さい。

请不要打开盖子。
内部无用户可以维修的器件。

Name: Caution Label (Small)
Type: 64-034-2002
Code No.: 100-416-400-10

About the TFT LCD

The TFT LCD is constructed using the latest LCD techniques, and displays 99.99% of its pixels. The remaining 0.01% of the pixels may drop out or blink, however this is not an indication of malfunction.

Notice for the FishHunter™ Drive

The FishHunter Drive™ is intended to operate as a navigational aid. Depending on sea and sensor conditions, the vessel may move unexpectedly.

Do not rely solely on this function while navigating.

When using this function, the customer is responsible for making decisions based on the following precautions.

- Be sure to check the safety of your surroundings before using this function.
- The propeller may rotate at any time. Therefore, keep well away from the propeller when in the water, and when getting in or out of the water. To prevent bodily injury or even death, observe the following:
 - 1) It is very dangerous to be in the water near the hull. Keep well clear of the hull.
 - 2) The hull can suddenly move in any direction, so take care not to fall overboard.
- Read the operator's manual carefully to ensure safe use.

To prevent bodily injury, attach the warning labels (FP64-01601, 001-634-970, 3 pcs.) supplied with the control unit (FAP-3011).

Attach one to the control unit and the other two in places easily noticeable, such as near the swim steps or the ladder, referring to "Attaching position" below.

Attaching position

NOTICE
<p>When attaching warning labels, observe the following:</p> <ul style="list-style-type: none">• Organic solvents and anti-corrosive sealants should be wiped off before attaching.• No organic solvents or anti-corrosive sealants should adhere to the label.• Labels should be attached on a flat, smooth surface.

Attach the labels to A and B or C as shown below.

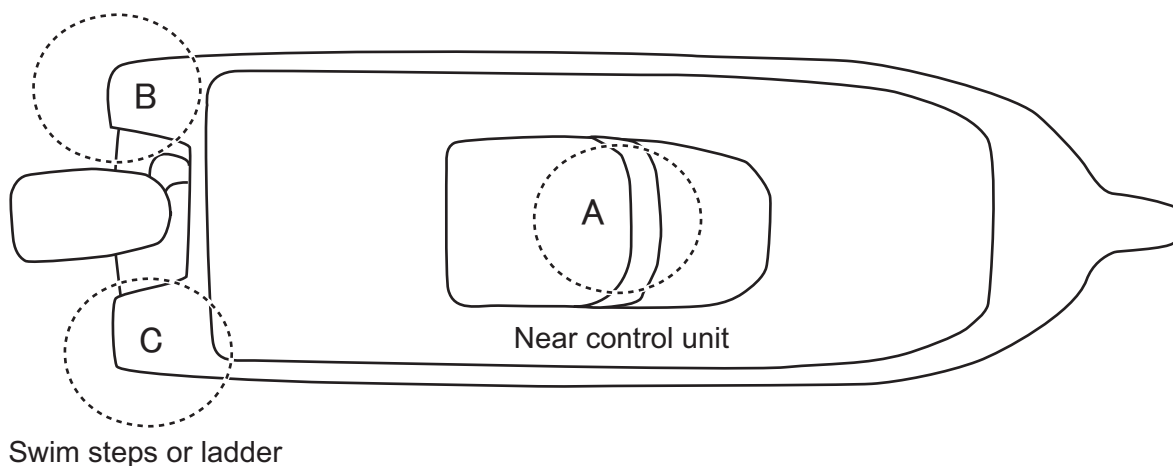

TABLE OF CONTENTS

FOREWORD	viii
SYSTEM CONFIGURATION	x
1. INTRODUCTION	1-1
1.1 Controls Overview	1-1
1.2 How to Turn Power On, Off	1-3
1.3 How to Adjust the Brilliance and Panel Dimmer	1-4
1.4 How to Change the Display Color	1-5
1.5 Steering Modes Overview	1-6
1.5.1 Graphic area.....	1-6
1.5.2 Data box area.....	1-9
1.6 Menu Operations Overview	1-10
2. STEERING MODES	2-1
2.1 Standby (STBY) Mode.....	2-1
2.2 AUTO mode.....	2-2
2.2.1 How to activate AUTO mode	2-2
2.2.2 ADVANCED AUTO mode	2-4
2.3 NAV Mode	2-5
2.3.1 How to activate NAV mode	2-5
2.3.2 Sailing method for NAV mode	2-7
2.3.3 Waypoint switching method.....	2-7
2.3.4 How to set the steering behavior of your boat after you arrive at a waypoint.....	2-8
2.4 TURN Mode.....	2-8
2.4.1 How to select a turn and start the turn	2-8
2.4.2 How to set the angle for turns	2-10
2.5 FishHunter™ Mode	2-11
2.5.1 How to select a FishHunter™ and start the turn	2-11
2.5.2 Types of turns available with FishHunter™	2-12
2.5.3 How to set up the FishHunter™ parameters.....	2-16
2.6 SABIKI™ Mode	2-17
2.6.1 How to use the SABIKI™ mode	2-18
2.6.2 How to adjust the response for SABIKI™ mode	2-19
2.7 DODGE and NFU Modes	2-20
2.7.1 How to use DODGE mode	2-20
2.7.2 How to use NFU mode	2-20
2.8 OVRD mode (only for EVC system)	2-21
2.8.1 OVRD mode activation in STBY mode.....	2-21
2.8.2 OVRD mode activation in the AUTO or NAV mode	2-21
2.9 Safe Helm Mode.....	2-22
2.10 Power Assist Mode.....	2-24
2.11 FishHunter™ Drive.....	2-25
2.11.1 Speed control	2-26
2.11.2 Deceleration during NAV mode	2-27
2.11.3 Point Lock™	2-29
2.11.4 SABIKI Lock™	2-31
3. ALERTS	3-1
3.1 How to Show the Alert Menu	3-2
3.2 How to Set the Watch Alert	3-2
3.3 How to Set the Deviation Alert.....	3-2
3.4 How to View the Alert Messages.....	3-3

TABLE OF CONTENTS

3.5	How to Show the Alert Log.....	3-3
4.	HOW TO CUSTOMIZE YOUR NAVPILOT	4-1
4.1	How to Setup the Parameters	4-1
4.1.1	Automatic parameter setup.....	4-1
4.1.2	Manual parameter setup.....	4-2
4.1.3	Speed calculation.....	4-4
4.2	Rudder Drive Level (For Fantum Feedback™).....	4-4
4.3	Nav Data Source.....	4-5
4.4	System Setup Menu.....	4-5
4.5	How to Open the NMEA2000 Sensor Menu	4-7
5.	GESTURE CONTROLLER GC-001.....	5-1
5.1	Gesture Controller GC-001 Overview	5-1
5.2	How to Turn the Power On/Off.....	5-1
5.3	Display Overview	5-2
5.4	GC-001 Menu Overview.....	5-3
5.5	GC-001 Alerts	5-5
5.5.1	Alert priority.....	5-5
5.5.2	Alert list	5-5
5.6	How to Adjust the Settings for Your GC-001.....	5-9
5.6.1	How to lock/unlock the keys.....	5-9
5.6.2	How to change the buzzer and vibration settings	5-9
5.6.3	How to enable/disable the gesture-to-turn feature	5-10
5.6.4	How to turn the screen's backlight on/off	5-10
5.6.5	How to set the sleep timer.....	5-10
5.6.6	How to use the [AUTO OFF] feature.....	5-11
5.7	How to Use the Gesture-To-Turn Feature	5-11
5.8	How to Connect (Pair) the GC-001 with Your NAVpilot-300	5-12
5.9	GC-001 Operations With NAVpilot-300.....	5-14
5.9.1	Standby (STBY) mode	5-14
5.9.2	Autopilot (AUTO) mode.....	5-15
5.9.3	Navigation (NAV) mode	5-16
5.9.4	TURN and FISHHUNTER™ modes	5-17
5.9.5	SABIKI™ mode.....	5-18
5.10	Diagnostics Menu.....	5-19
6.	MAINTENANCE, TROUBLESHOOTING.....	6-1
6.1	Preventive Maintenance.....	6-1
6.2	Replacement of Fuse	6-2
6.3	Troubleshooting	6-2
6.4	Diagnostics.....	6-4
6.4.1	Diagnostic menu	6-4
6.4.2	Processor unit test	6-5
6.4.3	Control unit test.....	6-6
6.4.4	Keyboard test.....	6-7
6.4.5	Screen test.....	6-7
6.4.6	Rudder test.....	6-8
6.4.7	Helm sensor test.....	6-11
6.5	System Data.....	6-12
6.6	Messages.....	6-13
6.6.1	Message pop-up display	6-13
6.6.2	Message menu.....	6-13
6.6.3	Message description	6-14
6.7	How to View the Sensors in Use.....	6-17

APPX. 1 MENU TREEAP-1
SPECIFICATIONS SP-1
INDEX IN-1

FOREWORD

A Word to the Owner of the NAVpilot-300

Congratulations on your choice of the NAVpilot-300. We are confident you will see why the FURUNO name has become synonymous with quality and reliability.

Since 1948, FURUNO Electric Company has enjoyed an enviable reputation for innovative and dependable marine electronics equipment. This dedication to excellence is furthered by our extensive global network of agents and dealers.

Your equipment is designed and constructed to meet the rigorous demands of the marine environment. However, no machine can perform its intended function unless properly operated and maintained. Please carefully read and follow the operation and maintenance procedures set forth in this manual.

Thank you for considering and purchasing FURUNO.

We would appreciate feedback from you, the end-user, about whether we are achieving our purposes.

Features

The NAVpilot-300 is comprised of a processor unit, display unit and a remote controller. This system is design for use in 25 ft or larger boats with inboard, outboard, in/outboard engines or DBW engines*.

The main features of the NAVpilot-300 are:

- Remote operation made possible with the standard supply GC-001 Gesture Controller.
- “Adaptive” technology which allows your NAVpilot to continue improving your boat’s steering on every voyage.
- Versatile, high-resolution color LCDs provide a variety of user-defined display configurations.
- Auto set-up and self-learning for boat speed and course.
- One-touch access to all operation modes.
- “FishHunter™” guides your boat in circle, orbit, spiral, figure-eight or zigzag maneuvers around fish schools or other targets.
- Compatible with NavNet TZtouch and NavNet TZtouch2 plotters.
- Network up to 3 NAVpilot-300 systems.

*: DBW (Drive By Wire) systems compatible with the NAVpilot-300 are as follows:

- VOLVO PENTA IPS
- YAMAHA Helm Master
- YANMAR VC10
- DOMETIC OPTIMUS (The software version of the connected Main PCM (Pump Control Module) must be “Rev. T” or later.)

Program numbers

System	Program no.	System	Program no.	System	Program no.
GC-001		FAP-3012		FAP-3011	
MAIN	6454030.xx	MAIN	6454026.xx	MAIN	6454024.xx
BOOT	6454029.xx	BOOT	6454027.xx	BOOT	6454025.xx
BLE	6454031.xx	BLE	6454032.xx		

“xx” denotes minor version changes.

CE/UKCA Declaration

With regards to CE/UKCA declarations, please refer to our website (www.furuno.com) for further information about RoHS conformity declarations.

Disclosure of information about China RoHS

With regards to China RoHS information for our products, please refer to our website (www.furuno.com).

SYSTEM CONFIGURATION

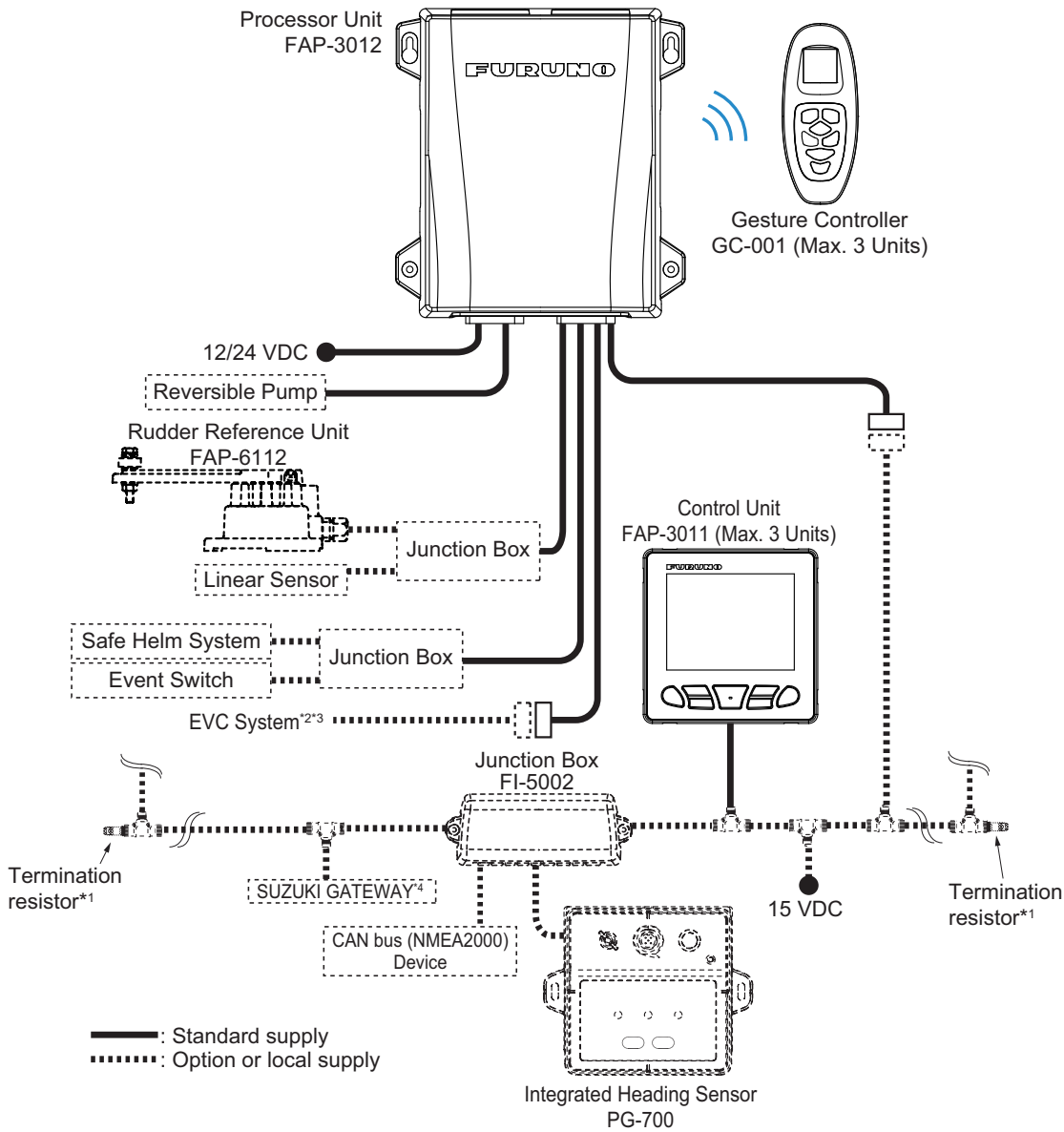

*1: Termination resistors must be installed at both ends of the backbone.

*2: EVC systems compatible with the NAVpilot are as follows:

EVC System	Remarks
VOLVO PENTA IPS	Requires VOLVO IPS gateway (available as an optional extra).
YAMAHA Helm Master	Requires YAMAHA HM gateway (available as an optional extra).
YANMAR VC10	-
Dometic Optimus	The software version of the Main PCM (Pump Control Module) must be "Rev. T" or later.

*3: Dometic Optimus is only available when using the SUZUKI Gateway.

*4: Below equipment is required to use FishHunter™ Drive.

Equipment	Compatible model
Throttle	67200-98L00, 98L10, 98L20
Outboards	DF140BG/115BG, DF150AP/DF200AP/175AP, DF300AP/250AP, DF350A/325A/300B
Gateway	34923-96L12 (34923-96L10, 96L11 is available with updating the software)
BCM	36770-98L01

1. INTRODUCTION

The NAVpilot-300 can be controlled either from the Control Unit (FAP-3011) or from the Gesture Controller (GC-001). For details regarding the GC-001, see chapter 5.

1.1 Controls Overview



The keys beep when operated to inform you if the operation was successful, or if the operation is not allowed. One beep indicates successful operation, two beeps indicates an operational error.

You can turn the key beeps off or on to suit your needs. See section 4.4 for details.





The figure below shows the FAP-3011 control unit. For GC-001 controls, see chapter 5.



The table below outlines the basic functions of the items highlighted in the figure above. Detailed instructions on their use is described chapter 2.

Name	Description
PORT 10 key 	<u>Short press:</u> <ul style="list-style-type: none"> • With Auto active: Change course by 10° to port. • Open the selected setup menu. <u>Long press:</u> <ul style="list-style-type: none"> • With Auto active: Start a 180° (factory default) turn to port. • With NAV mode active: Switch to Dodge (port turn) mode
PORT 1 key 	<u>Short press:</u> <ul style="list-style-type: none"> • With Auto active: Change course by 1° to port. • Increase the value for the selected setting. • Move the selection cursor upwards in the menu. • With the system in STBY: Switch between digital indications and dial indications. <u>Long press:</u> <ul style="list-style-type: none"> • With Auto active: Start a 90° (factory default) turn to port.

1. INTRODUCTION

Name	Description
<p>Power/Brill key</p> 	<p><u>Short press:</u></p> <ul style="list-style-type: none"> • With the system turned off: Turn the system on. • With the system turned on: Show the brilliance settings window. • With the brilliance settings window open: Cycle through the brilliance levels. <p><u>Long press:</u></p> <ul style="list-style-type: none"> • Turn the system power off (three second countdown appears).
<p>Auto Pilot key</p> 	<ul style="list-style-type: none"> • Close all open windows and menus. • Switch to STBY (standby) mode. <p><u>With no destination selected at the GPS navigator:</u></p> <ul style="list-style-type: none"> • Switch to AUTO mode. <p><u>With a destination selected at the GPS navigator:</u></p> <ul style="list-style-type: none"> • Open the mode ([NAV]/[AUTO]/[CANCEL]) selection window.
<p>STBD 1 key</p> 	<p><u>Short press:</u></p> <ul style="list-style-type: none"> • With AUTO mode active: Change course by 1° to starboard. • Decrease the value for the selected setting. • Move the selection cursor downwards in the menu. • With the system in STBY: Switch between digital indications and dial indications. <p><u>Long press:</u></p> <ul style="list-style-type: none"> • With Auto active: Start a 90° (factory default) turn to starboard.
<p>MENU key</p> 	<p><u>Short press:</u></p> <ul style="list-style-type: none"> • Open the [TURN] menu. • With the menu open: Go back one level in the menu. <p><u>Long press:</u></p> <ul style="list-style-type: none"> • Open/close the main menu.
<p>STBD 10 key</p> 	<p><u>Short press:</u></p> <ul style="list-style-type: none"> • With AUTO mode active: Change course by 10° to starboard. • Open the selected menu. <p><u>Long press:</u></p> <ul style="list-style-type: none"> • With AUTO mode active: Start a 180° (factory default) turn to starboard. • With NAV mode active: Switch to Dodge (starboard turn) mode

1.2 How to Turn Power On, Off

Note: When the Heading Sensor PG-500/PG-700 is connected, turn on the NAVpilot and wait a few minutes before you leave port, or steer the boat manually. This allows time for the PG-500/PG-700 heading data to stabilize.

Turning the power on

To turn the power on, press . The unit releases a “beep” to indicate when the startup procedure begins.

The equipment shows product information, connects to the processor unit and begins the startup test. The start up test checks the ROM, RAM and backup data for the processor unit and control unit. The test also

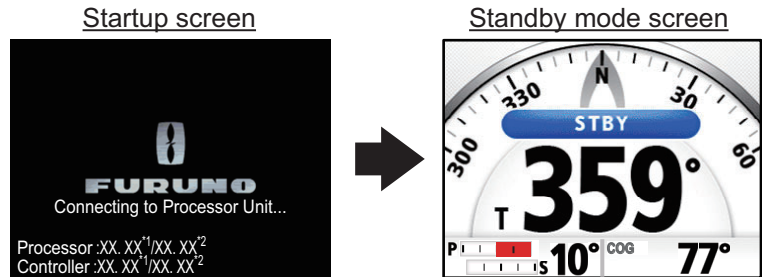

*1: Indicates the application version number.
*2: Indicates the boot program version number.

checks for the presence of heading information from the heading sensor and rudder angle information from the rudder reference unit. When all test results are indicated as "OK", the Auto Pilot main screen appears.

If a problem occurs with any of the tested items, an error message, shown in the table on the following page, appears. The test result is also indicated as "NG" (No Good). Follow the information below to restore normal operation. If you cannot restore normal operation, contact your dealer for information.

Priority	Error message	Meaning
High ↑	Communication error with the processor unit. Check connections. Contact your local dealer if the problem recurs.	The Control Unit failed to connect to the Processor Unit. Turn the system off and check the connections between the units. Re-connect any loose or disconnected cables. If the problem recurs after restarting the system, contact your local dealer.
	Processor has failed the startup test. Contact your local dealer.	The Processor Unit may be faulty. Contact your local dealer and arrange for service.
	Controller has failed the startup test. Contact your dealer.	The Control Unit may be faulty. Contact your local dealer and arrange for service.
	Processor backup data is corrupt or lost. Processor factory defaults will be restored. Press any key to continue.	Backup data for the Processor Unit is not usable. The system will restore factory default settings for the Processor Unit. Press a key to start the process.
Low ↓	Controller backup data is corrupt or lost. Controller factory defaults will be restored. Press any key to continue.	Backup data for the Control Unit is not usable. The system will restore factory default settings for the Control Unit. Press a key to start the process.
	Control unit and processor unit software versions do not match. Update software to latest version.	There is a difference in the software versions for the Processor and Control Units. Contact your local dealer to update the software of both units to the latest version.

1. INTRODUCTION

You can acknowledge and hide any of these errors. To acknowledge and hide an error message, press any key on the Control Unit. If there is more than one error, the next error appears.

Turning the power off





To turn the power off, press and hold . A countdown message appears on the screen. When the countdown completes, the control unit is turned off. If a GC-001 which is paired with the system is within range, the remote control is also turned off.

1.3 How to Adjust the Brilliance and Panel Dimmer

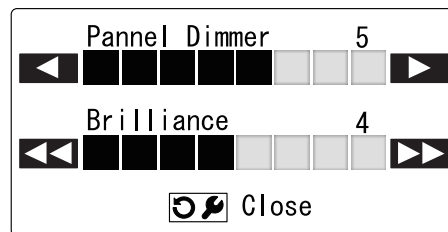
The **Power/Brill** key () also adjusts the screen brilliance and panel dimmer when the system is turned on.

1. Press  to show the screen for the adjustment of panel dimmer and brilliance.



2. Press  to increase, or press  to decrease, the panel brilliance.
3. Press  to increase, or press  to decrease, the screen contrast.
4. Press  to close the screen.
Also, if there is no operation for a short while, this screen automatically closes.

1.4 How to Change the Display Color

You can change the color scheme used in the display to suit your viewing conditions and requirements. There are two preset color schemes available: White (easier to view when there is sunlight or bright lights) and Black (easier to view in the dark, where there is little light available). The figure below is an example of both color schemes.

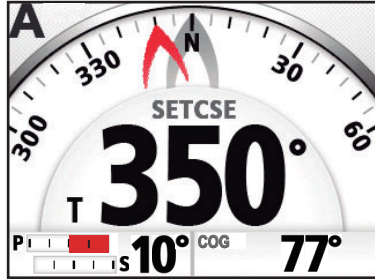



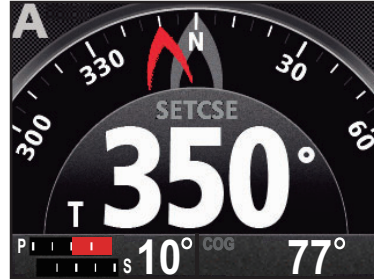





Example: [Display Color] = [White]



Example: [Display Color] = [Black]

To change the color scheme, do the following:

1. For all modes other than Safe Helm mode, press and hold  to open the menu.
For Safe Helm mode, press  to open the [TURN] menu, then select [MENU].
For details on how to use the menus, see section 1.6.
2. Press  or  to select [Display Color], then press .
3. Press  or  to select [White] or [Black], then press .
4. Press  to close the menu.

1.5 Steering Modes Overview

The NAVpilot-300 has following steering modes:

- Standby (STBY)
- Navigation (NAV)
- Safe Helm
- Autopilot (AUTO)
- Override (OVRD)
- NFU (Non Follow Up)
- FishHunter™
- Turn
- Dodge

The displayed contents for each mode are divided into two main areas: the graphics area and the data box area. The top section of the screen shows indications for the steering mode currently in use and equipment status.

For details on each turn mode, see chapter 2.

The figure below shows an example of the autopilot main screen, for reference.

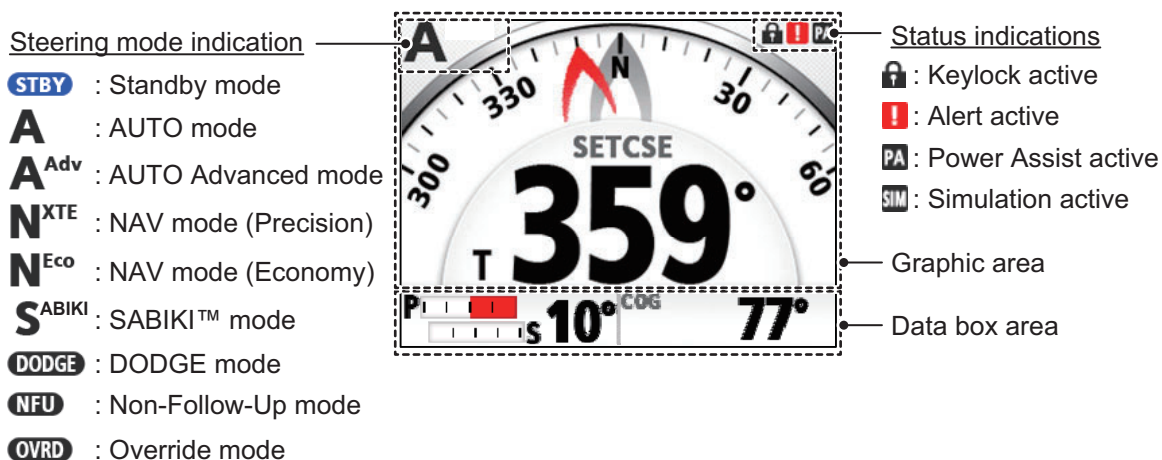

Note: When input data for following items exceed the display range, the NAVpilot indication changes to show an asterisk with the upper (or lower) limit value. For example, when input data for SOG exceed the upper limit, the NAVpilot indicates “*99.9kn”.

- SOG
- STW
- XTE
- Rudder

1.5.1 Graphic area

The contents of the graphic area change, depending on the steering mode in use.

Steering mode	Displayed contents/Function
Standby	Compass or digital display. Toggle between compass and digital displays is only available while the system is in standby mode. See section 1.5.2.
Autopilot, Override, NFU, Dodge	Data is display in the format selected during standby (digital or compass).
Navigation	Data is display in the format selected during standby, however, if compass is selected, the Highway display is shown.
Turn	Display contents are dependent on the turn mode in use. See section 2.4.1.
FishHunter™	Display contents are dependent on the FishHunter™ mode in use. See section 2.5.1.
Safe Helm	Display contents are dependent on the mode at recovery. See AUTO mode and NAV mode above.

Compass display

The compass display show ship’s heading and course. This display requires heading data. Depending on the compass display settings ([Installation Menu] → [Display Set-up] → [Compass Display]), the course indication, heading indication and the compass dial behave differently, as outlined in the table below. See the Installation Manual for how to change the display settings.

	[Compass Display] is set to [Head Up]	[Compass Display] is set to [Course Up]
Compass dial	Compass dial rotates to keep the heading indication at the top-center of the display.	Compass dial rotates to keep the course indication at the top-center of the display.
Heading indication	Indication is fixed in place.	Indication moves with heading changes.
Course indication	Indication moves with course changes.	Indication is fixed in place.

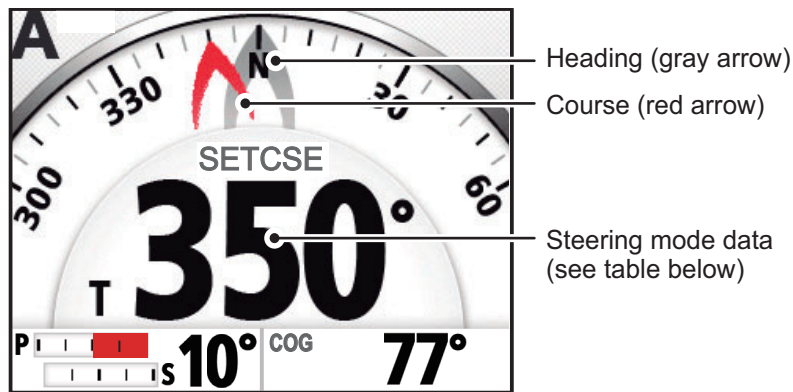

The steering mode data changes depending on the steering mode, as shown in the table below.

Steering mode	Displayed data
Standby, Non Follow Up, Override	Heading.
Autopilot, Dodge	Course.
Safe Helm	Safe Helm heading. (Flashing)

1. INTRODUCTION

Digital display

The digital display shows data in numerical format. Depending on the steering mode, the displayed data, and the location at which the data is displayed, changes. There are two methods used to display digital data, as shown in the figures below.

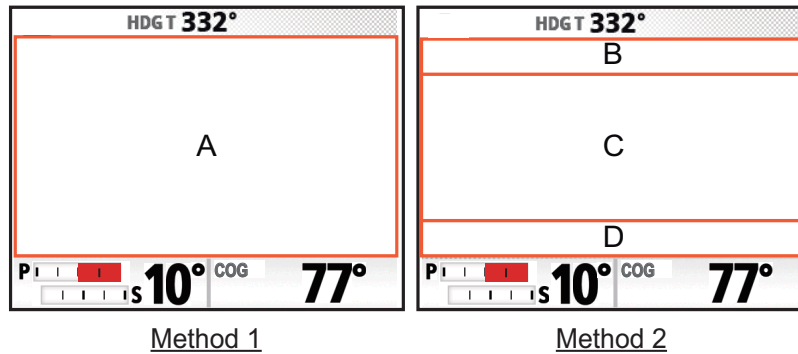

The following table outlines the location in which data is displayed, based on steering mode.

Steering mode	Display method	Data and display location
Standby, Non Follow Up, Override	Method 1	A: Heading
Autopilot, Dodge	Method 1	A: Course
Navigation	Method 2	B: Destination/waypoint C: Cross Track Error D: Time To Go (TTG)
Safe Helm (recovery mode: Autopilot)	Method 1	A: Safe Helm heading
Safe Helm (recovery mode: Navigation)	Method 2	B: Destination/waypoint C: Cross Track Error D: Time To Go (TTG)

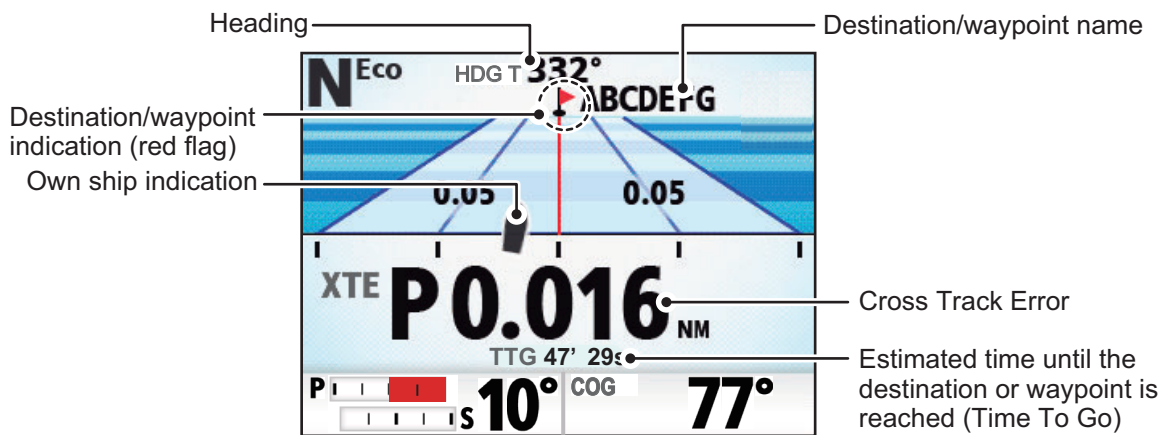

Highway display

The highway display shows a graphic image of your boat as it travels along the set course. The own ship indication moves to show your location in the course.



Compass/digital display toggle (Standby mode only)

To toggle between compass and digital display, do the following:

1. Press  to place the system in standby.
2. Press  to show the toggle the display.

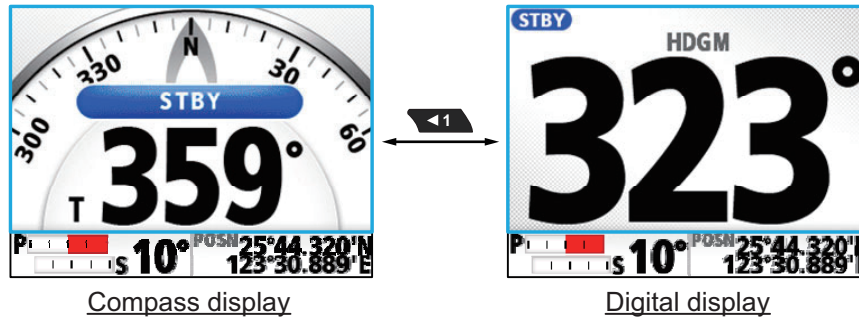

1.5.2 Data box area

The data box area can show the following data:

- Left-hand side: Rudder angle indication, or, for Fantum Feedback™, rudder direction indication.

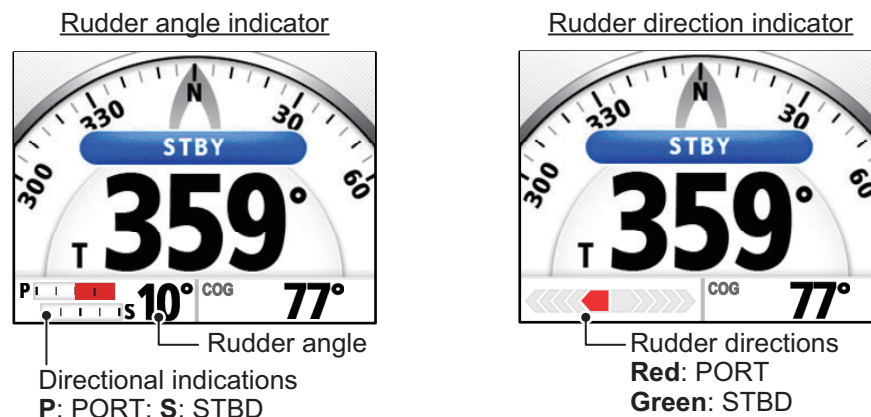



- Right-hand side: OS position (POSN), Course Over Ground (COG), Speed Over Ground (SOG) or Speed Through Water (STW).

In STBY mode, the data shown in the right-hand side of the data box can be changed. In all other modes, the data selected in standby is shown.

Data selection (Standby mode only)

To change the data shown in the right-hand side of the data box, do the following:

1. Press  to place the system in standby.
2. Press  to show the cycle through the data. The cyclic order is shown in the figure below.

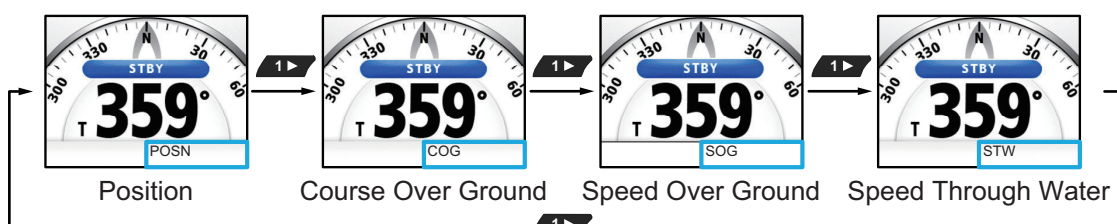

1.6 Menu Operations Overview

Depending on the steering mode in use, the contents of the menus changes. For details regarding menu contents, see "MENU TREE" on page AP-1.

1. In AUTO, STBY, NAV or OVRD mode, press and hold  to open the menu.

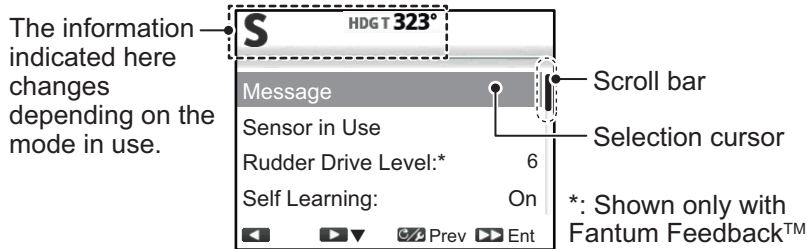



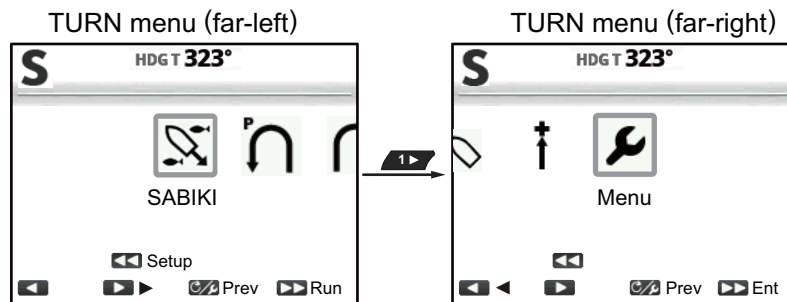









If  is not pressed for a long enough period of time, the [TURN] menu appears. In this case, you can select the menu from the far right of the [TURN] menu. For Safe Helm mode, there is no short-cut key. You can only select [Menu] from the [TURN] menu in Safe Helm mode.





After initial power on, the menu shows [SABIKI] at the center.

Note: During a turn, or with Fish Hunter™/NFU/DODGE mode active,  has no function. To open the menu, change modes, then follow the above step.

2. Press  or  to select (highlight) a menu item, then press .
 moves the selection cursor upwards in the menu and  moves the selection cursor downwards in the menu.
 If there is a scroll bar visible at the left of the menu, there are menu items other than those already visible.
3. For menus with “layers”, repeat step 2 as necessary. To go back one layer in the menu, press .
4. Press  or  to select an option or setting, then press .
 increases the setting value and  decreases the setting value.
5. Press and hold  to close the menu.

Note: For the sake of brevity, the procedures outlined in this manual use the following terminology/phrases when referring to menu operations.

- “Open/close the menu.” This means “Open/close the menu as outlined in step1 or step 5 of the above procedure.”
- “Select xxx.” This means “Press  or  to select xxx.” in a similar manner as outlined in steps 2 and 3 of the above procedure.

2. STEERING MODES

This chapter describes the steering modes and functions of the NAVpilot.

Note: For boats with external switches connected, the switch acts as a “go to standby” switch.

Notices for switching steering modes

When switching the steering modes while the heading sensor PG-500 or PG-700 is still initializing, keeping in mind the following points:

- The message "INITIALIZING HEADING SENSOR. THIS TAKES TWO MINUTES, PLEASE WAIT." may appear when switching steering modes. In this case, wait approx. two minutes to initialize the heading sensor, then switch steering modes again.
- When the heading sensor is restarted because of power supply interruption, etc. while the autopilot controls the rudder, the message indicated above appears and autopilot stops the rudder control. If this happens, switch to STBY mode and maneuver the boat manually.

2.1 Standby (STBY) Mode

After turning on the power, the equipment goes to the standby (STBY) mode. This is a manual steering mode. When sailing into or out of a harbor, steer the boat in the STBY mode by using the steering wheel (helm) of your boat.

While standby mode is active, the indication "STBY" appears on the screen at the following locations:

- Where standby mode is set to show the compass or highway display: Center of the screen.
- Where standby mode is set to show the digital display: Top-left of the screen.

If the compass is displayed, your heading is shown as a gray arrow on the compass and the compass spins to keep the arrow pointing to the top of the screen.

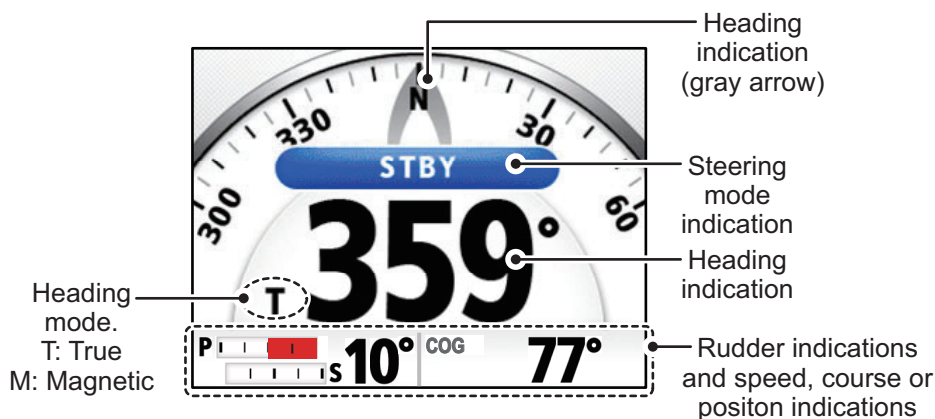

Note: Gesture Controller GC-001 is usable while the NAVpilot-300 is in standby. See chapter 5 for details.

2.2 AUTO mode

The AUTO mode steers the boat automatically on a course set by the operator.

The AUTO mode will not compensate for the effects of wind or tide, which can push you off course athwart in the ship direction. Use the AUTO mode for short, straight voyages. Otherwise switch to the NAV mode (see section 2.3).

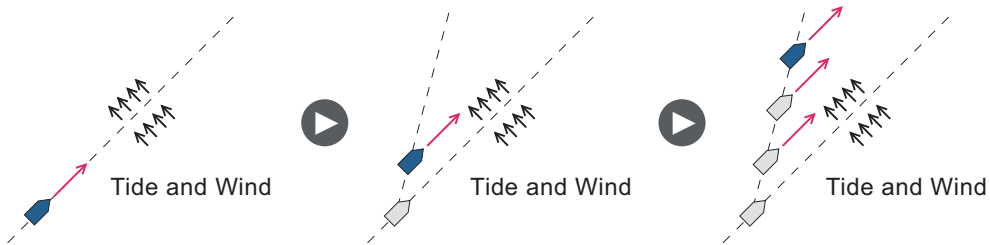

2.2.1 How to activate AUTO mode

To activate AUTO mode, follow the procedure below.

1. Direct the boat toward required course.



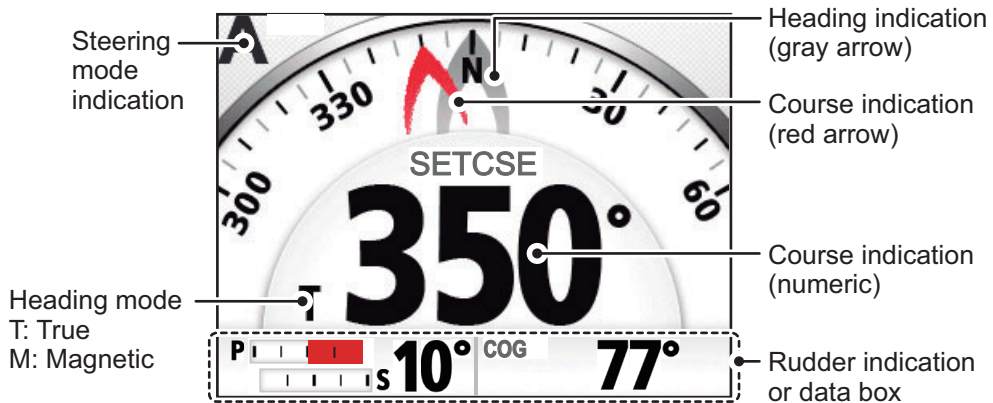

2. Press .

Your boat automatically maintains the current course when the key is pressed. When the heading changes from the set course, the NAVpilot automatically adjusts the rudder to return the boat to the set course. While the AUTO steering mode is active, the indication "A" appears at the top-left of the screen.



Note: If the NAVpilot-300 is connected to an GPS navigator with an active destination or route, and  is pressed, NAV mode is activated instead of AUTO mode (see section 2.3). Press the key a second time to show the AUTO screen.

3. To change the course setting in the AUTO mode, press the appropriate key, referring to the table below.

Key	Name & Description	Key	Name & Description
	PORT 10 key Change course by 10° to port.		STBD 10 key Change course by 10° to starboard.
	PORT 1 key Change course by 1° to port.		STBD 1 key Change course by 1° to starboard.

4. To exit the AUTO mode to steer manually, press . Steer your boat by the helm.

Note 1: During AUTO mode, if , , or is pressed, the following associated message appears. The turn angles shown in the below messages are based on factory default settings. To start the turn, press the appropriate key once more.

: "Starting STBD turn (90°)"

: "Starting STBD turn (150°)"

: "Starting PORT turn (90°)"

: "Starting PORT turn (150°)"

Note 2: The above operation is available from the GC-001. See section 5.9. The Control Unit releases a "beep" sound (requires [Key Beep] in the [System Setup] menu to be set to [ON]) under the following conditions:

- The mode is changed to AUTO mode from external equipment.
- The set course is changed from external equipment.

Note 3: While AUTO mode is active, if a route or destination is selected from a connected GPS navigator, NAV mode becomes available. A confirmation message appears. Press , or as appropriate.

Note 4: You can also activate AUTO mode from the [TURN] menu. Press to show the [TURN] menu, then select [AUTO] ().

2.2.2 ADVANCED AUTO mode

The AUTO mode keeps a set course, but your boat's course can change by the effects of tide and wind. To adjust for the effects of tide and wind, use the ADVANCED AUTO mode. The NAVpilot calculates your course according to your current position and heading, then sets a virtual "waypoint" in its memory to navigate towards. If either tide or wind begins to push you off course, the NAVpilot corrects your heading accordingly.

Your NAVpilot must be connected to a GPS navigator which outputs position data (Latitude and Longitude).

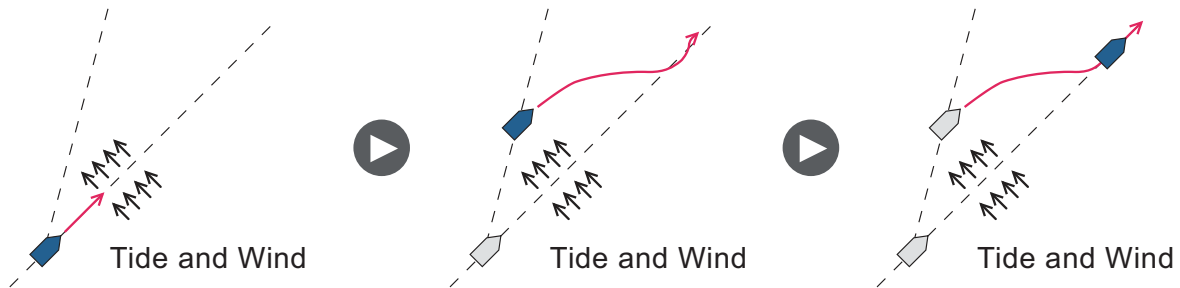

To get the Advanced AUTO mode, follow the procedure below.

1. With AUTO mode active, open the menu.

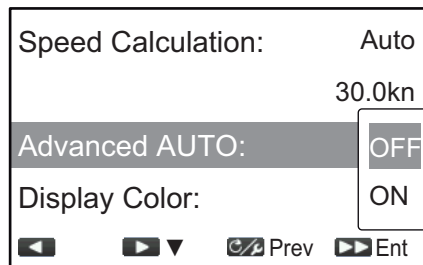

2. Select [Advanced AUTO] to show the advanced auto options window.
3. Select [ON].
Select [OFF] to deactivate Advanced AUTO mode.

When Advanced AUTO mode is activated, the mode indication at the top-left of the screen changes as shown in the figure to the right. **A^{Adv}**

Note: If there is no position data input to the NAVpilot-300 and you attempt to change the steering mode, an error message appears and an sound alert is released. Press any key to silence the alert, then check data input to the system.

4. Close the menu.

Note: How strictly the ADVANCED AUTO mode keeps the course depends on the [NAV Mode] setting in the [Auto Pilot Option] menu. [Economy] keeps the course within 0.03 NM and [Precision] keeps the course within 0.01 NM.

2.3 NAV Mode

NAVpilot steers the boat towards the current waypoint while compensating for the effects of tide and wind.

When connected to a GPS Navigator, NAVpilot steers the boat to follow a series of waypoints in sequence. When you arrive at each waypoint or destination, audible and visual alerts are activated.

The NAVpilot takes approximately 15 seconds to activate the NAV mode after the NAVpilot receives the destination information.

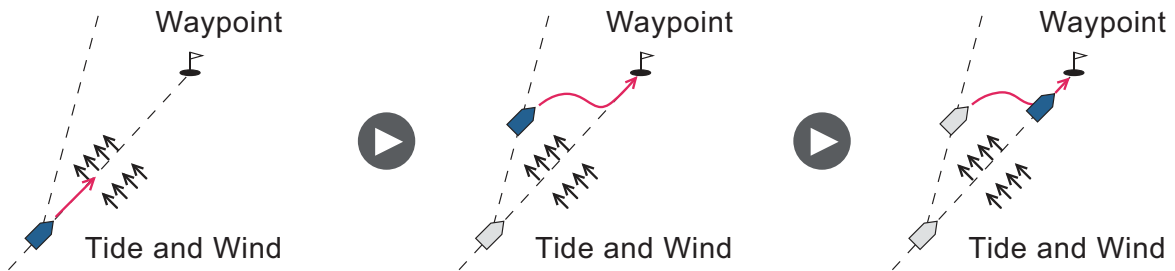



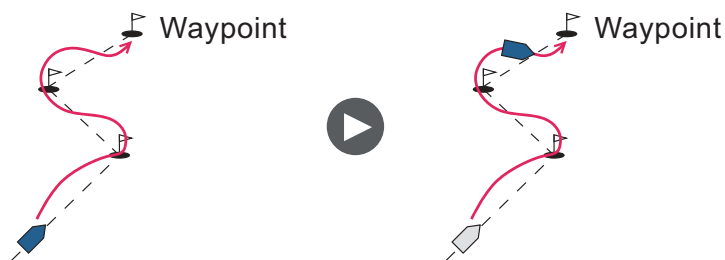

Steering to a single waypoint



Steering a route (a series of waypoints)

2.3.1 How to activate NAV mode

To activate NAV mode, follow the procedure below.

1. Set the destination waypoint (or route) on the GPS navigator or chart plotter.
To navigate a route, make sure that your plotter is navigating towards the nearest or required waypoint before you put the NAVpilot into the NAV mode.
2. Manually steer the boat toward the waypoint.
3. Press . A confirmation window appears.
4. Press ,  or  to select [Economy], [Precision] or AUTO mode, as appropriate.
 - [Economy]: keeps the course within 0.03 NM.
 - [Precision]: keeps the course within 0.01 NM.

2. STEERING MODES

While NAV mode is active, the steering mode indication appears at the top-left of the screen, accompanied by the XTE setting indication. The figure below shows an overview of the NAV mode screen.

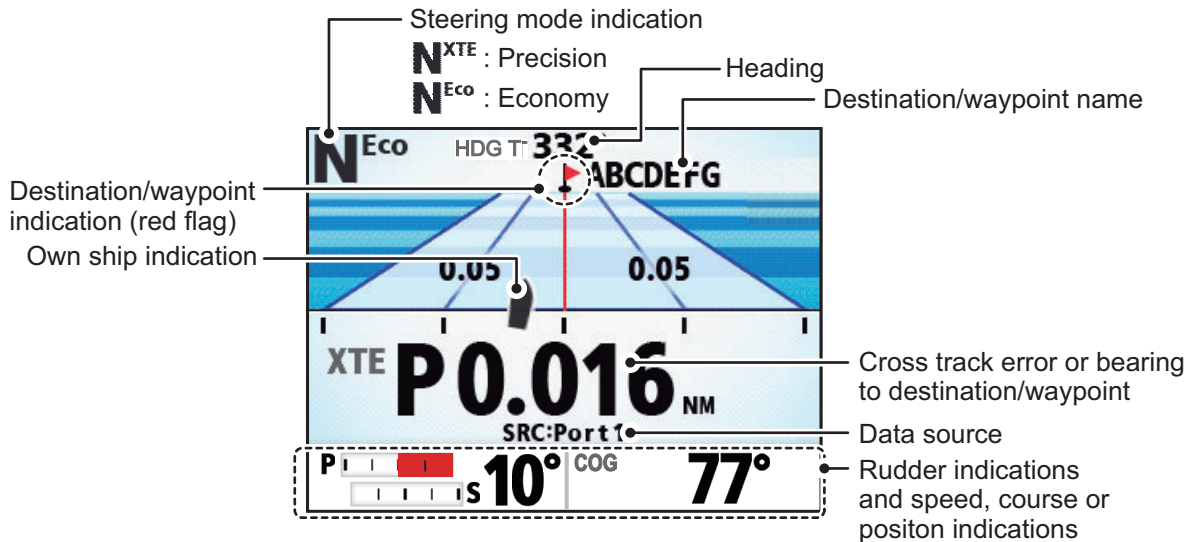



- To deactivate switch from NAV mode to SBTY mode, press . An audible alert sounds and the mode is changed. Use the steering wheel (helm) to steer the boat.

Note 1: The course reading on the NAVpilot is not always the same as the waypoint direction shown on the chart plotter.

Note 2: The above operation is available from the GC-001. See section 5.9. The Control Unit releases a “beep” sound (requires [Key Beep] in the [System Setup] menu to be set to [ON]) under the following conditions:

- The mode is changed to AUTO mode from external equipment.
- The set course is changed from external equipment.

Note 3: You can also activate NAV mode from the [TURN] menu. Press  to show the [TURN] menu, then select [NAV] ().

2.3.2 Sailing method for NAV mode

Your boat can go off course between waypoints in the NAV mode. This can occur when, for example, a command is received from the remote controller. To return to the course set, two methods are available: [Precision], and [Economy].

[Precision] and [Economy] both use the XTE (cross-track error) value to steer the boat towards your original course before dodging. [Precision] provides for tighter course keeping, within 0.01 NM of the set course. [Economy] gives less tighter course keeping, within 0.03 NM of the set course.

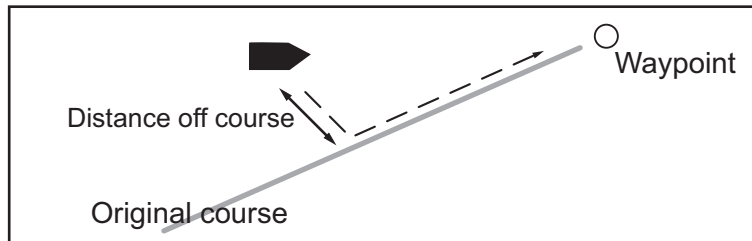

To select the sailing method, follow the procedure below.

1. With NAV mode active, open the menu.
2. Select [NAV Mode].
3. Select [Economy] or [Precision] as appropriate.
4. Close the menu.

2.3.3 Waypoint switching method

When you arrive at a waypoint on a route in the NAV mode, you can switch to the next waypoint automatically or manually.

To select the waypoint switching method, follow the procedure below.

1. With NAV mode active, open the menu.
2. Select [Waypoint Switching].
3. Select [Auto] or [Manual] as appropriate.

[Auto]: switches to the next destination waypoint when your boat is within the arrival alarm area (set on the chart plotter). When your boat is within the arrival alarm area, the buzzer sounds and a notification message appears. After five seconds, the buzzer stops and the message disappears. However, if your GC-001 is turned on at this time, the notification message is still displayed. Press any key to remove the message.

[Manual]: requires operator confirmation before switching to the next waypoint. For manual switching, the NAVpilot sounds an audible alarm when the boat arrives at the destination waypoint and a confirmation message appears. This confirmation message appears only on the FAP-3011 Control Unit.

Press  to acknowledge the message and switch to the next waypoint. The system releases another audible alert and a message appears on the FAP-3011 Control Unit to inform that the waypoint was changed. This message also disappears after five seconds, however key operation on the GC-001 is required to remove the message.

Note: Manual waypoint changing is only available from the FAP-3011.

4. Close the menu.

2.3.4 How to set the steering behavior of your boat after you arrive at a waypoint

The FishHunter™ mode, when enabled, can control the steering behavior of your boat after it reaches the last waypoint in a route. For details on the FishHunter™ mode, see section 2.5.

To set the steering behavior for use with the FishHunter™ mode, follow the procedure below.

1. With NAV mode active, open the menu.
2. Select [AFTER ARRIVAL] to show the after arrival options window.
3. Select the appropriate option.
 - Go Straight: Continue on the same heading.
 - Orbit to PORT: Continuously turn to port, “orbiting” the final waypoint.
 - Orbit to STBD: Continuously turn to starboard, “orbiting” the final waypoint.
 - Figure Eight PORT: Turn in a figure-eight motion to the port direction.
 - Figure Eight STBD: Turn in a figure-eight motion to the starboard direction.
4. Close the menu.

2.4 TURN Mode

The TURN mode turns the boat once only, in the selected direction. For repeated turns, use the FishHunter™ mode (see section 2.5).

2.4.1 How to select a turn and start the turn

Turn mode has two types of turns available: Turn1 (default: 180° turn) and Turn2 (default: 90° turn). In STBY, AUTO and NAV modes, you can select the turn direction (port or starboard). Further, the angle of the turn can be changed.

To activate TURN mode, follow the procedure below.

1. Press the **MENU** key () to show the Turn menu.

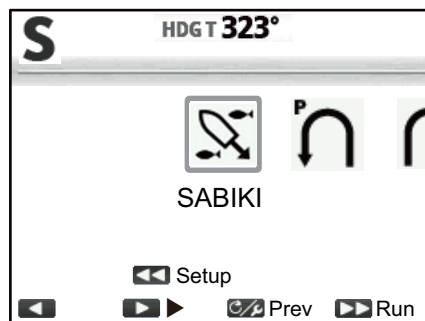

2. Select a turn. The cursor highlights current selection.

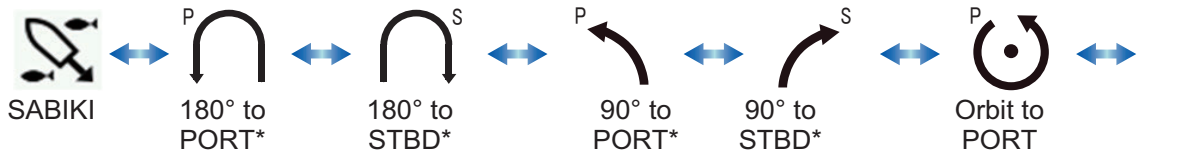

**: Turn angle for these turns depends on menu setting.
The default for Turn1 turns is 180° and the default for Turn2 turns is 90°.*

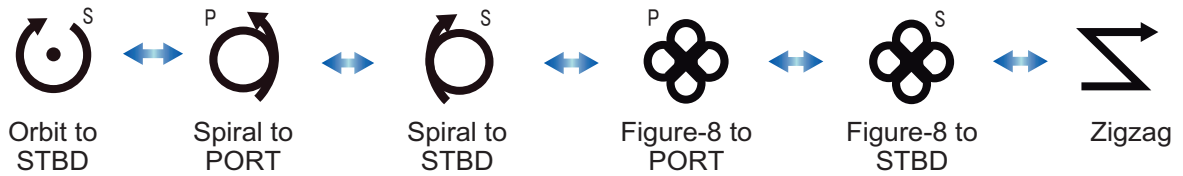

Note: Turn angle can be selected before the turn is started, by pressing . For details, see section 2.4.2.

3. Press  to start the turn.

After you start the turn, an information message appears, and the audible alert sounds three times. The on-screen indications change during the turn in a manner to that shown in the example figure below.

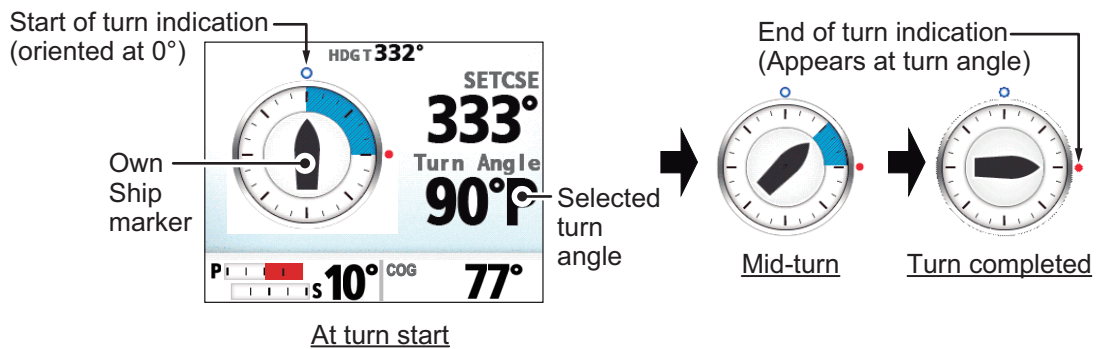



When the turn is completed, an information message appears.

Note: Operation from the GC-001 is available in TURN mode. See section 5.4.



2.4.2 How to set the angle for turns

You can set the angle at which turns for Turn1 and Turn2 are made. To set these angles, follow the procedure below.

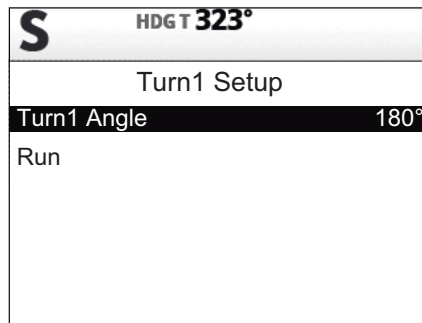
1. Press the **MENU** key () to show the [TURN] menu.
2. Select the appropriate turn and direction.
3. Press  to show the settings window. The example below shows the Turn1 settings.



The default turn angle for Turn1 turns is 180° and the default angle for Turn2 turns is 90°.

4. Select the angle item. A popup window appears and the angle can be adjusted.
5. Set the desired turn angle. Press  to decrease the value, or  to increase the value.
6. Select [Run]. Your boat now starts the turn using the angle set at step 4.

Note: The angles for Turn1 and Turn2 can also be set from their respective menus in the [Other Menu] → [Auto Pilot Option] menu.

2.5 FishHunter™ Mode

The FishHunter™ mode is a unique feature of FURUNO's NAVpilot series. Find a fish target with your FURUNO sonar/sounder or bird target with your FURUNO radar and feed the destination to the NAVpilot. The NAVpilot will activate the FishHunter™ mode to perform orbit, spiral, figure eight or zigzag maneuvers around the specified target.

2.5.1 How to select a FishHunter™ and start the turn

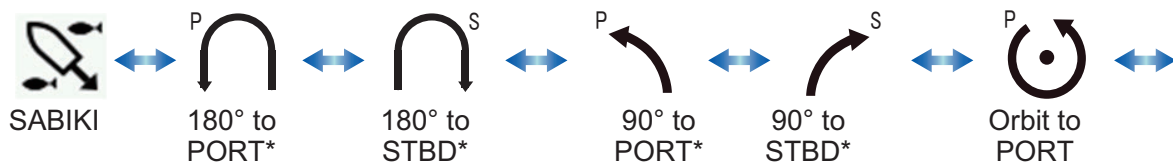

FishHunter™ mode can be activated from STBY, AUTO or NAV modes and can be adjusted to turn either to port or starboard (direction cannot be set for Zigzag).

1. Press the **MENU** key () to show the Turn menu.
2. Select the desired turn.
The cursor-selected item is highlighted with a blue box.
For details on each turn, see section 2.5.2.

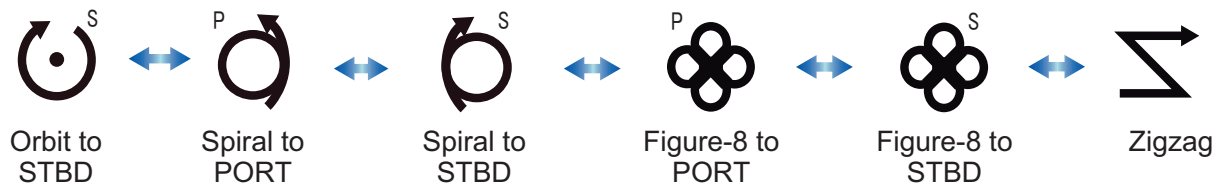

**: Turn angle for these turns depends on menu setting.
The default for Turn1 turns is 180° and the default for Turn2 turns is 90°.*



3. If you want to change the parameters for the turn, do 1) - 4) below. If you do not need to change the parameters, go to step 4 of this procedure.
 - 1) Press  to show the setting menu for the turn. If a setting menu does not appear, the parameters for that turn cannot be changed.
 - 2) Select the parameter you want to change. A popup window appears.
 - 3) Set the parameter as desired.
 - 4) Select [RUN] to start the turn, or press  to go back to the settings.
4. Press  to start the turn. The message "Fish Hunter mode activated." appears.

Note: The orbit and spiral turns require that the speed of the boat be less than 10 knots. If the speed is higher, the message "Too fast for this mode. Reduce speed to less than 10 knots." appears. Reduce the boat's speed to less than 10 knots.

The Own Ship indication moves during turns, as an indication that the boat is turning. This is not always an accurate depiction of the direction in which the boat is facing, or of the boat location.

To escape from the turn, press . The message "Turn complete" appears.

Note: Operation from the GC-001 is available in TURN mode. See section 5.4.

2.5.2 Types of turns available with FishHunter™

Orbit turn

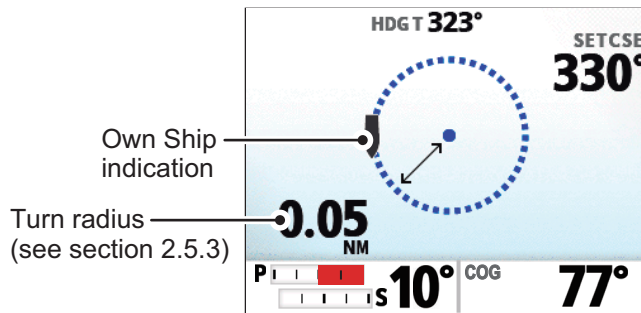

Your boat orbits around its current position. This function requires a chart plotter or GPS navigator.

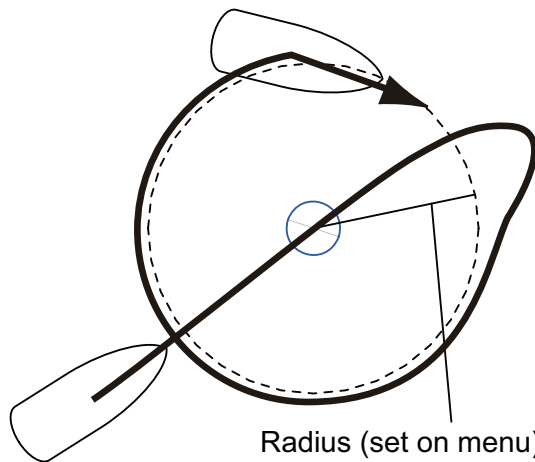

Note: Where [On Arrival] is set to [Orbit to PORT] or [Orbit to STBD] in the [Auto Pilot Option] menu, the last waypoint becomes the center-point for the orbit turn.

Spiral turn

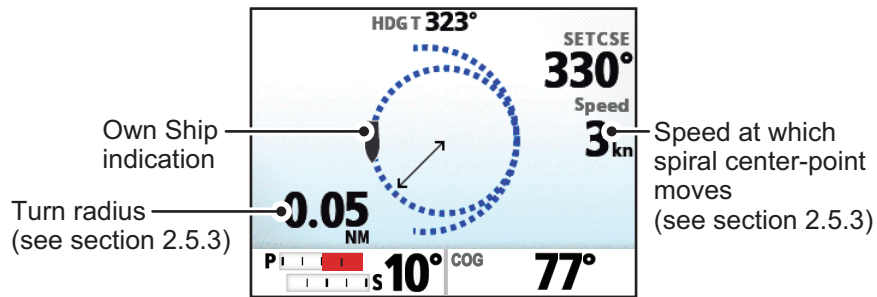

If the spiral turn is initiated from NAV mode, the waypoint/destination name appears on the spiral turn screen with the "NAV" icon indicating where the turn was initiated from.

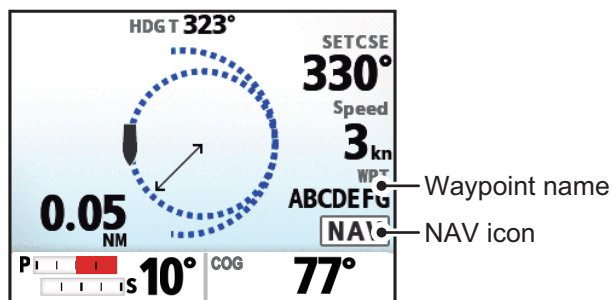

The boat spirals in the direction of current heading (STBY), set course (AUTO) or the course to the next waypoint (NAV) that was active at the moment that the spiral turn is started. The spiral speed can be set in the menu. The arrival alarm must also be active on the chart plotter.

The boat will continue to spiral until the **AUTO** or **STBY** key is pressed.

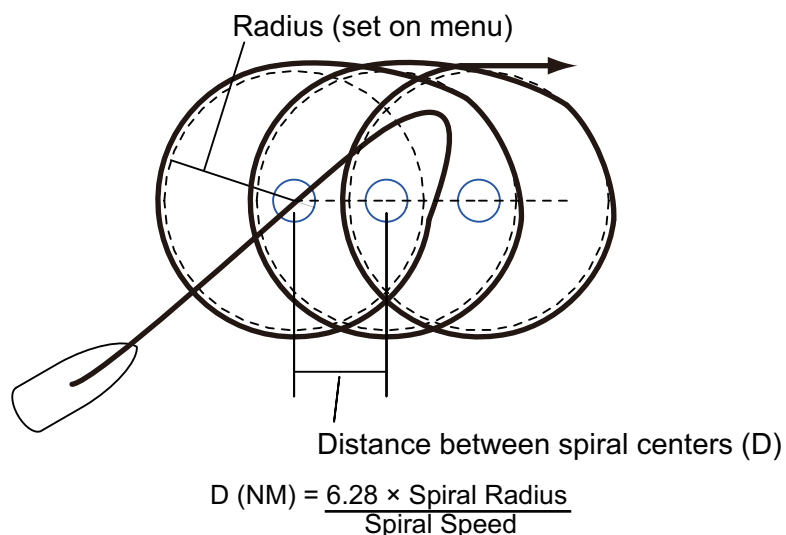

Note: If the boat does not enter the arrival alarm area, the NAVpilot does not switch to the next waypoint. To prevent this, set the arrival alarm range as large as possible and activate the perpendicular function on the chart plotter.

2. STEERING MODES

Figure-eight turn

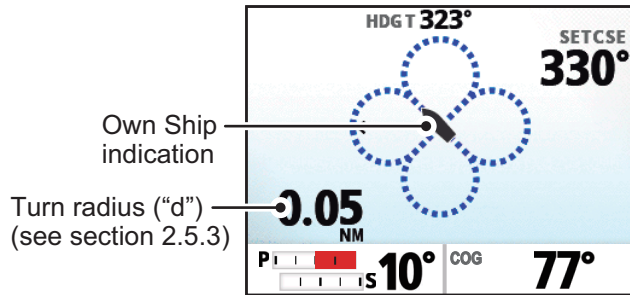

After the boat has traveled the distance "d" set on the menu, it starts turning in a figure-eight pattern, automatically returning to the position where the figure-eight was initiated. "d", the radius, is set on the menu.

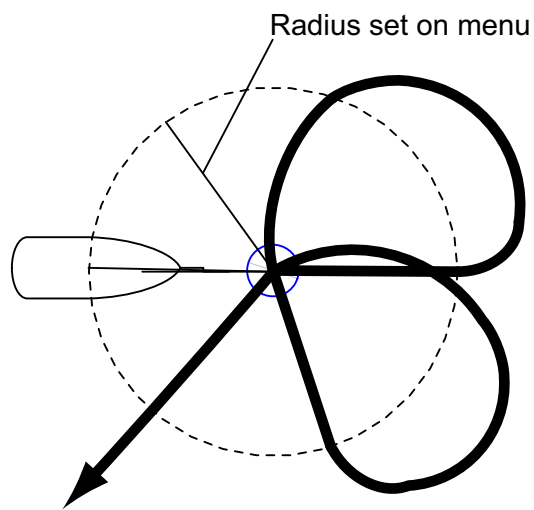

Zigzag turn

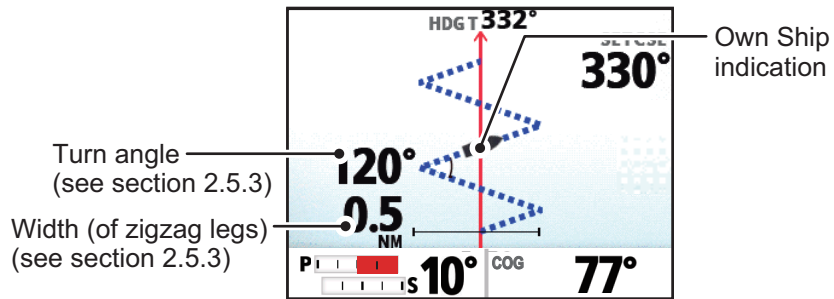

If the zigzag turn is initiated from NAV mode, the waypoint/destination name appears on the zigzag turn screen with the "NAV" icon indicating where the turn was initiated from.

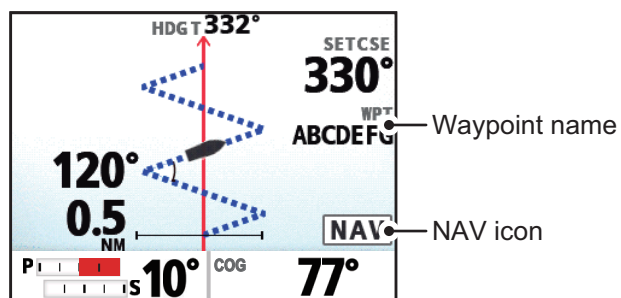

The zigzag turn starts from current position. The turn angle, number of turns and turn width can be set on the menu. This turn is available in the AUTO and NAV modes.

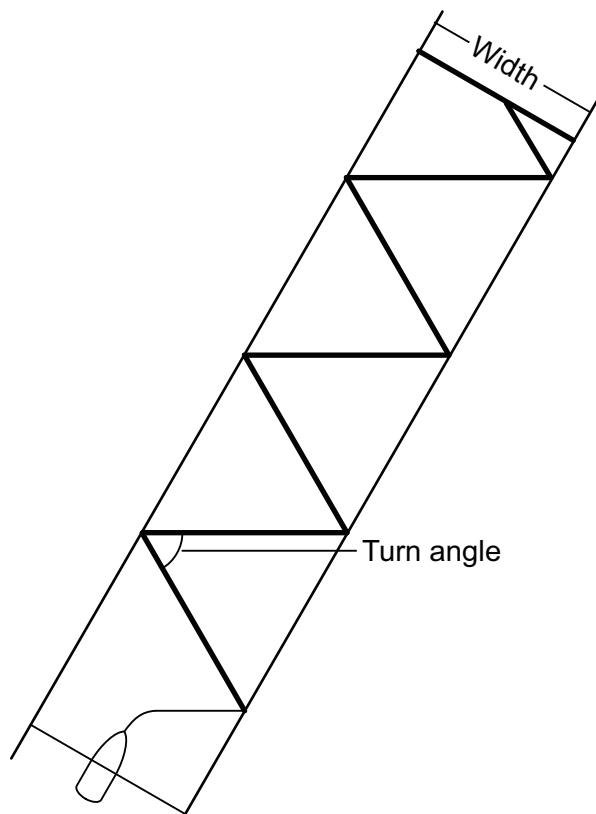

2.5.3 How to set up the FishHunter™ parameters

To set up the parameters for FishHunter™, follow the procedure below.

1. Open the menu.
2. Select [Other Menu].
3. Select [Fish Hunter Option]. The FishHunter™ menu appears.

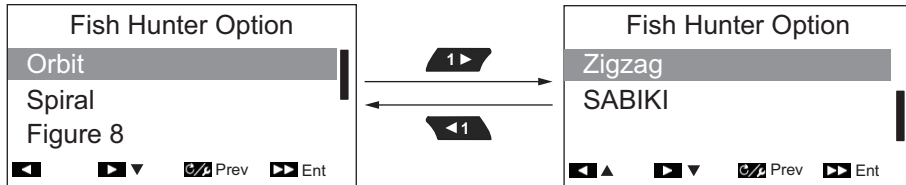

4. Select the turn you want to set up. The turn parameters appear, as shown in the figures below.

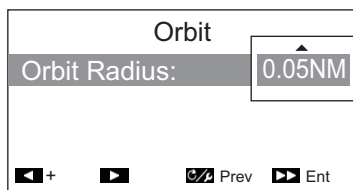

Setting range:
0.05 to 9.99 NM

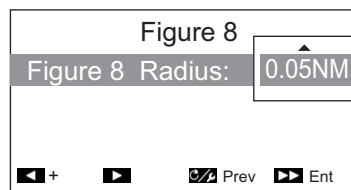

Setting range:
0.05 to 9.99 NM

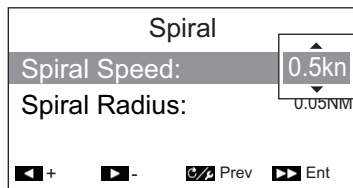

Setting range:
0.1 to 3.0 kn



Setting range:
30 to 150°

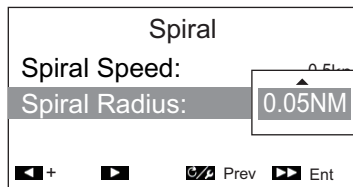

Setting range:
0.05 to 9.99 NM

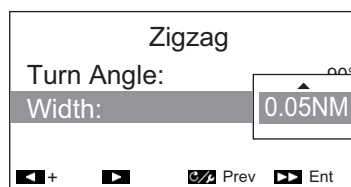

Setting range:
0.05 to 0.99 NM

5. Change the parameters as required.
6. Close the menu.

Note: While FishHunter™ mode is active, you can press  to access the menu for the turn in use (Zigzag excluded).

2.6 SABIKI™ Mode

The SABIKI™ mode controls the rudder while the boat is using reverse thrust, effectively keeping the stern facing windward (or into the current) while keeping the bow leeward (or with the current).

Due to the SABIKI™ mode's ability to control the rudder, only the throttle requires periodic adjustment to keep the boat facing in the same direction. The reduction of required adjustments allows you to focus more on fishing, even with a light crew on-board.

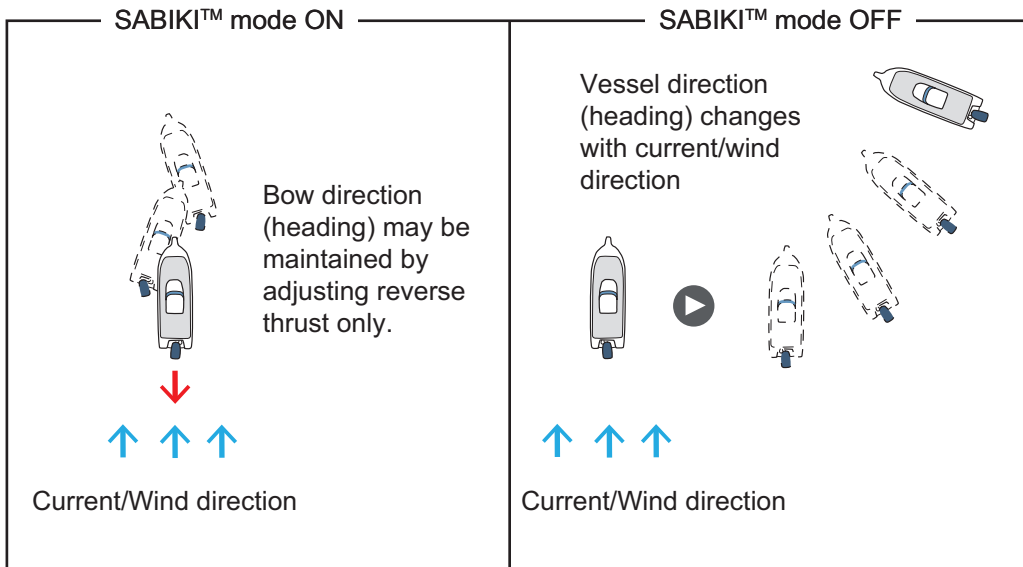

SABIKI™ mode is designed for the following boat types:

- Boats with [BOAT TYPE] set to [Outboard], [In/Outboard], [EVCS Outboard] or [EVCS In/Out] at installation.
- Boats with a length of 40 feet or less.

Important notes regarding the SABIKI™ mode

- SABIKI™ mode requires speed data input from an external sensor and is not available with manual speed input.
- While SABIKI™ mode is active, Dodge mode functions are not available.
- If the deviation alert is released, immediately check your boat's heading.
- When the setting for Deviation Alert is more than 45° and SABIKI™ mode is activated, the Deviation Alert setting is fixed at 45°. When SABIKI™ mode is deactivated, the setting reverts to its original value.
- The steering accuracy in SABIKI™ mode is dependent on the reversing capabilities of the outboard engines.
- SABIKI™ mode requires a speed of less than 5 kn. Attempts to activate SABIKI™ mode at speeds over 5 kn will show the message "REDUCE SPEED FOR SABIKI (<5KN)".
- To prevent over-steering while using SABIKI™ mode, keep within reaching distance of the throttle.
- For configurations with Fantum Feedback™, make sure the helm is centered (rudder facing directly forwards) before activating SABIKI™ mode. If the helm is not centered, SABIKI™ mode may steer the boat incorrectly.





2.6.1 How to use the SABIKI™ mode

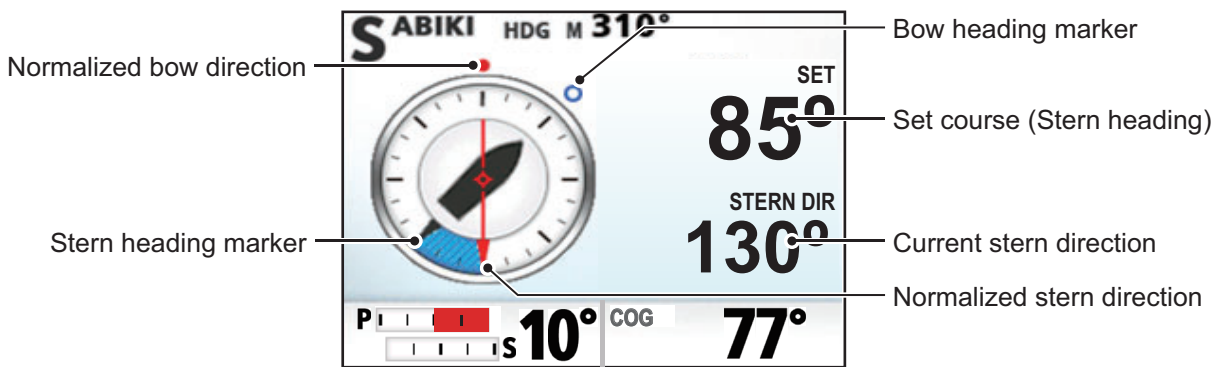



Preparations for the SABIKI™ mode

- Check that there is a speed sensor connected to the processing unit. Check that [Speed Calculation] is set to [Auto].
 - In the [Ship's Characteristics] menu, set [Boat Type] to [Outboard] or [In/Outboard], [EVCS-Outboard] or [EVCS-In/Out].
1. Reduce the vessel's speed to less than 5 knots.
 2. Orient the vessel with the stern in a windward direction, or into the current, then center the rudder.
 3. Push the  key to show the turn menu.
 4. Select [SABIKI]. The SABIKI™ mode is activated and a screen similar to the one shown below is displayed.



The vessel direction (heading) may be adjusted manually during the SABIKI™ mode. This is helpful in situations such as wind direction change.

Press the , ,  or  key to adjust the bow heading. Use the bow direction as a reference when adjusting course.

The  key adjust the bow heading by 1° to port and the  key adjusts the bow heading by 10° to port. Similarly, the  and  keys adjust bow heading to starboard.



When the stern is not facing the wind or current, increase reverse throttle as necessary, to adjust direction. Where this method does not rectify the vessel direction, see section 2.6.2.

Note: You can also activate SABIKI™ mode from the GC-001 (see section 5.4). Further, if [Key Beep] in the [System Setup] menu is set to [ON], the system release a short beep in the under the following circumstances:

- SABIKI™ mode is activated from an external device.
- Set course is changed from an external device.

2.6.2 How to adjust the response for SABIKI™ mode

If you find that SABIKI™ mode cannot keep the correct heading, follow the procedure below to adjust the response time.

1. In STBY mode, press  to open the menu.
2. With [SABIKI] highlighted, press . The [SABIKI] response setting appears.



You can also access the SABIKI™ response setting while SABIKI™ mode is active, by pressing the  key.



3. Select [SABIKI Response].
4. Adjust the setting as required.
 - Where SABIKI™ mode over-steers: Increase the response time. If SABIKI™ mode over-steers after this adjustment, reduce reverse throttle.
 - Where SABIKI™ mode under-steers: Decrease the response time. If SABIKI™ mode under-steers after this adjustment, increase reverse throttle.
5. Select [Run].



2.7 DODGE and NFU Modes



In situations where you need to quickly take control of the helm to avoid an obstruction, use either DODGE or NFU mode.

- DODGE mode: Used with NAV, TURN and FishHunter™ modes.
- NFU (Non Follow Up) mode: Used in STBY mode.

2.7.1 How to use DODGE mode



Press and hold  or  to steer appropriately until the boat has cleared the obstruction. The equipment goes into DODGE mode and the audible alarm sounds when one of the above keys is operated, to alert you to dodge operation. Note also that the indication **DODGE** appears at the top-left of the display.

To cancel DODGE mode, release  or . For NAV and FishHunter™ modes, the system returns to the mode in use before DODGE mode was activated. For TURN mode, the system switches to AUTO mode after DODGE mode is canceled.

Note 1: If  and  are pressed simultaneously, the boat is steered towards the heading at the time when the two keys are pressed.

Note 2: DODGE mode can also be activated from the GC-001. See section 5.9.3 and section 5.9.4.

2.7.2 How to use NFU mode

Press and hold  or  to steer appropriately until the boat has cleared the obstruction. The equipment goes into NFU mode and the audible alarm sounds when one of the above keys is operated, to alert you to dodge operation. Note also that the indication **NFU** appears at the top-left of the display.

To cancel NFU mode, release  or . The system returns to STBY mode.

Note: NFU mode can be activated from the GC-001. See section 5.9.1.

2.8 OVRD mode (only for EVC system)

When the EVC system controls the rudder, the OVRD (override) mode is automatically enabled. The autopilot can not control the boat in the OVRD mode.

Note: The OVRD mode is enabled when [BOAT TYPE] is set to [EVCS-Pod Drive], [EVCS-Outboard], [EVCS-Inboard] or [EVCS-In/Out].

2.8.1 OVRD mode activation in STBY mode

When the OVRD mode activates in the STBY mode, [OVRD] appears at the top-left position of the display. At this time only the menus are operative. When the EVC system releases control of the rudder, the autopilot goes to the STBY mode.

Note: For systems with DOMETIC OPTIMUS connected, a three second countdown message appears when OVRD mode is deactivated. When the countdown completes, the system automatically switches to STBY mode.

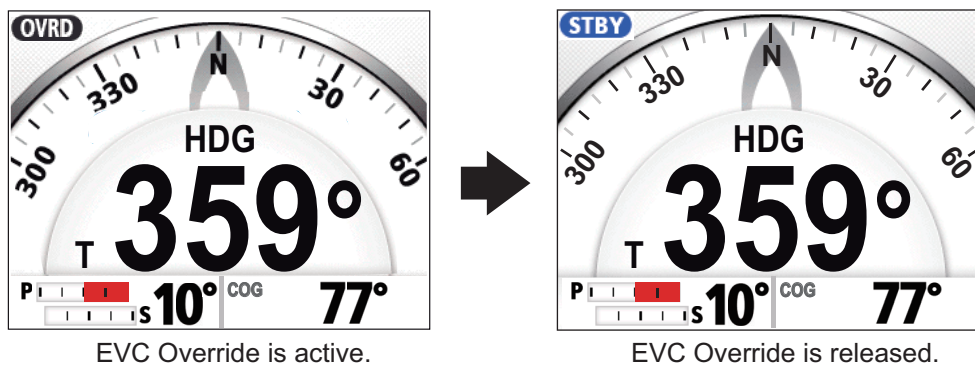

2.8.2 OVRD mode activation in the AUTO or NAV mode

For VOLVO IPS, YAMAHA HM or YANMAR VC10 EVCS configurations

When the OVRD mode activates in AUTO or NAV mode, the audio alarm sounds, the pop-up message "EVC OVERRIDE" appears, and the mode indication at the top-left position of the display shows [OVRD]. Press any key to stop the alarm and erase the pop-up. When the EVC system releases control of the rudder, the autopilot goes to STBY mode.

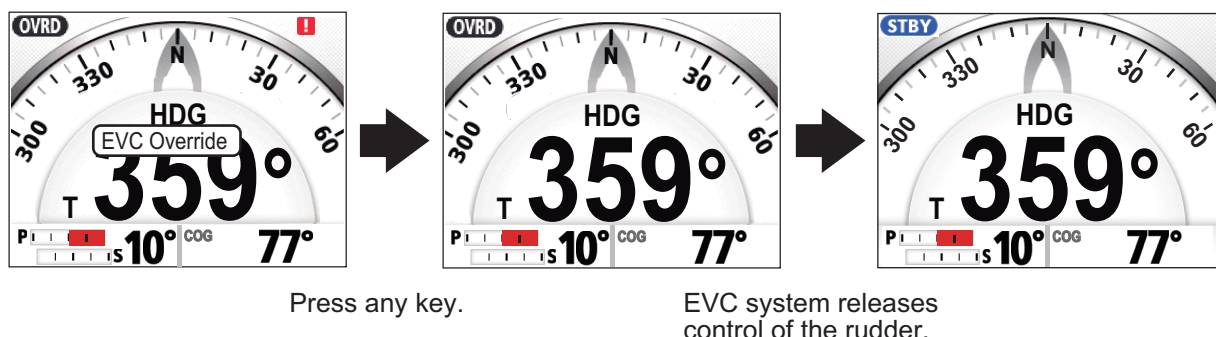

For DOMETIC OPTIMUS EVCS configurations

When the OVRD mode activates in AUTO or NAV mode, the audio alarm sounds, the pop-up message "EVC OVERRIDE" appears, and the mode indication at the top-left position of the display shows [OVRD]. When the EVC override is complete, the previous mode is activated. A countdown message "Resuming control in x seconds." (x indicates a number from 1 to 5) appears to indicate when the system mode changes.

Note: The audio alarm, released when OVRD mode is activated, can be disabled from [Safe Helm Beep] in the [System Setup] menu.

2.9 Safe Helm Mode

The safe helm mode, available with the Accu-Steer FPS 12V/24V drive unit, temporarily switches the NAVpilot to manual steering for the specified time interval when the helm is steered in an automatic steering mode (AUTO, NAV, etc.). This prevents continued turning of the helm. The mode and course indications flash when the safe helm mode activates.

The safe helm mode is deactivated and the previous automatic steering mode is restored in the following situations:

NAV mode: When the data from helm sensor is not input for the set time on [Return Delay]*.

AUTO mode: When cruising straight ahead and the data from helm sensor is not input for the set time on [Return Delay]*.

*: See section to set [Return Delay].

The figure below shows an example of the Autopilot screen, for reference.

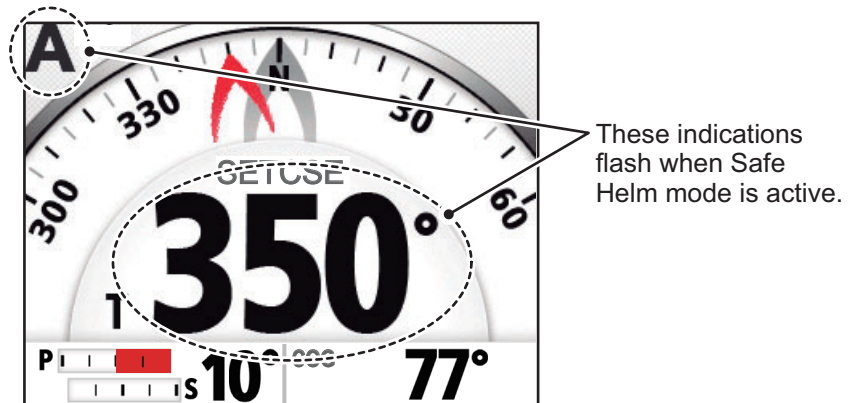

How to set the safe helm mode

1. With the system in STBY or OVRD mode, open the menu.
2. Select [Other Menu].
3. Select [Safe Helm Setup]. The [Safe Helm Setup] menu appears.
4. Select [Safe Helm].
5. Select [ON].
6. Select [Return Delay].
7. Set the return delay as required.
The setting range is 1-20 seconds.

With NAV mode active: When the data from helm sensor is not input for the set time, NAV mode is restored.

With AUTO mode active: When cruising straight ahead and the data from helm sensor is not input for the set time, the previous steering mode is restored.

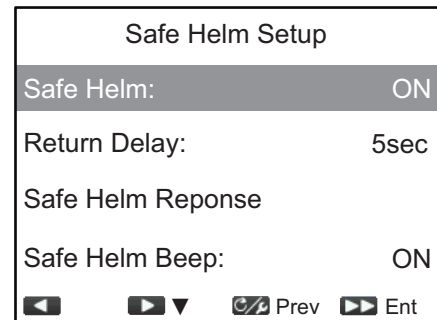

8. Select [Safe Helm Response]. The Safe Helm Response settings appear.

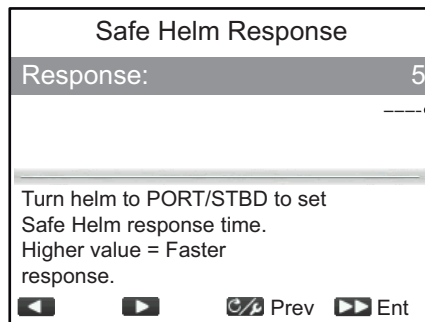

When the rudder is operated, "PORT" or "STBD" appears, depending on the direction in which the rudder moved.

9. Select [Response].
The higher the setting, the faster the response (setting range: 1 to 10).
10. Press  to go back to the Safe Helm menu.
11. Select [Safe Helm Beep].
[Safe Helm Beep] turns the beep on or off when the safe helm mode is activated.
12. Select [ON] to release an audible alert when Safe Helm is activated, or [OFF] for silent Safe Helm activation.
13. Close the menu.

2.10 Power Assist Mode

The power assist mode, available with the Accu-Steer FPS 12V/24V type drive, customizes manual steering to your own preferences. This mode requires connection to the Accu-Steer FPS 12V/24V type drive, and requires installation settings.

The mode is available during the safe helm mode and the STBY mode. The indication “PA” appears at top of the screen when the mode is active.

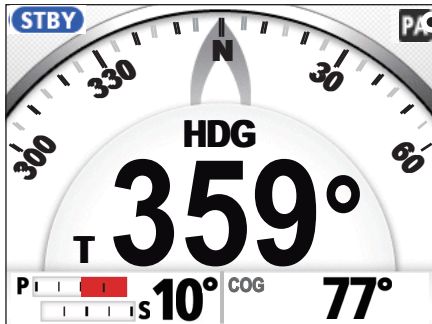

The “PA” indication appears when Power Assist mode is active.

How to set the power assist mode

1. With the system in STBY or OVRD mode, open the menu.
2. Select [Other Menu].
3. Select [Power Assist Setup].
The [Power Assist Setup] menu appears.
4. Select [Power Assist].
5. Select [ON].
When this is done the menu items for power assist appear.
6. Select [For Speeds Under].
7. Set the highest speed at which power assist activates. The setting range is 1.0 to 25.0 knots (default: 10.0 knots).
Note: When the power assist activates at high speed, the boat can be turned more greatly than the turn as intended. Set [For Speeds Under] according to the boat and rudder feature.
8. **If you want power assist in the STBY mode**, set [Power Assist STBY] to [ON].
9. Select [Power Assist Rudder Speed].

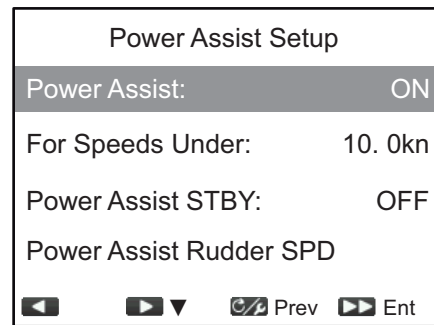

The example to the right shows the Power Assist Rudder Speed settings window for a vessel with Fantum Feedback™. Your screen may differ slightly.

10. Set [Power Assist Rudder Speed]. The setting range is 1 to 10 (default setting: 10). The higher the setting, the stronger the power assist.
11. Close the menu.

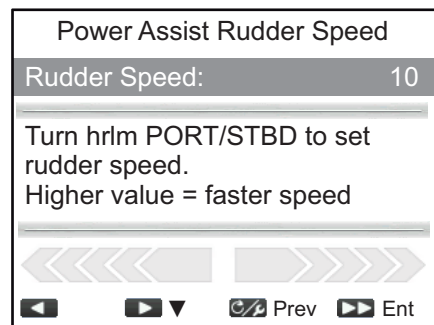



How to confirm the rudder steering

Turn the helm to port and starboard and confirm that the power assist activates according to the helm steering. If the power assist only works in one direction, do the helm sensor test (see section 6.4).

Note: Rudder steering confirmation should only be done when the ship is docked or cruising at low speed in a safely navigable area.

2.11 FishHunter™ Drive

FishHunter™ Drive is a proprietary feature. When used in combination with a suitable SUZUKI outboard motor (see "SYSTEM CONFIGURATION") and NAVpilot-300, the outboard motor can automatically control the rudder and throttle from the NAVpilot-300. The main functions include constant speed control, and automatic deceleration in NAV mode, Point Lock™, and SABIKI Lock™. When the FishHunter™ Drive is in use, the following icon appears in the upper right corner of the screen.

Icon	Meanins
 (Gray)	Communication with SUZUKI GATEWAY is established.
 (Blue)	Speed control (see section 2.11.1) is in place.
 (Green)	<p>Shown in one of the below cases.</p> <ul style="list-style-type: none"> • Point Lock™ is active. • SABIKI Lock™ is active. • Deceleration control is active upon arrival at the final waypoint. <p>Note: After decelerating to the final waypoint, if the driver returns to STBY mode without returning the remote control lever to N, engine control will stop and the ENG icon will blink. Return the lever to N to enable engine control.</p>

Note 1: Before using any of the functions, check the upper right corner of the screen to make sure that the gray SPD icon is displayed, meaning that communication with SUZUKI GATEWAY is established.

Note 2: Be aware that turning off the engine without the remote control lever in N will trigger an alarm from the NAVpilot-300.

Note 3: The following plotters are compatible with the FishHunter™ Drive.

- TZT9F/12F/16F/19F (NavNet TZtouch3 series): v3.01 or higher.
- TZTL12F/15F/TZT2BB (NavNet TZtouch2 series): v8.01 or higher.
- GP-1871F/1971F: v4.0 or higher.

Note 4: Update the GC-001 version to v1.07 or higher.

Note 5: The requirements for sensors are as follows:

2. STEERING MODES

Heading sensor	GPSsensor
Azimuth accuracy: $\pm 1.0^\circ$ or less.	GNSS: Within 10 m (drms, HDOP<4)
Azimuth resolution: 0.1° or less.	WAAS: Within 3 m (drms, HDOP<4)
Output cycle: 100 ms or less.	MSAS: Within 7 m (drms, HDOP<4)
Delay time: Within 75 ms.	Positioning cycle: 10 Hz or more.
	Smoothing: 1 second

2.11.1 Speed control



The NAVpilot-300 controls and maintains the selected ship's speed. Appropriate acceleration and deceleration are applied by taking into account load changes, throttle response characteristics, and disturbances such as wind, waves, and currents.

Notice for using speed control

- Speed control is not available when using SABIKI™ mode, Point Lock™ or SABIKI Lock™.
- Do not use the speed control when the speed is near the ship's planing speed, because the ship's speed will not be stable.
- When the remote control lever is a dual lever, use it in the single lever mode. Speed control is not available in the dual lever mode.

How to start the speed control

Note: Set the remote control lever to N before opening the menu.

1. Short press  to open the menu.
2. Long press , to enable setting. Select [Speed Control ON] and press . Then, the blue SPD icon in the upper right corner of the screen changes to grey.

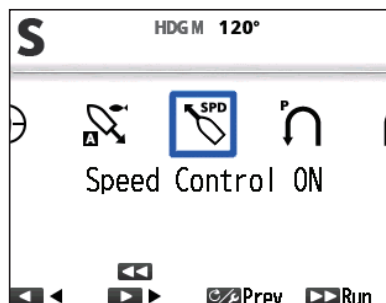



3. The ship runs at a constant speed with the remote control lever in [F] position, The indication SETSPD blinks while the NAVpilot is preparing for adjustment of speed control. When the indication stops blinking and lights up, you can adjust the speed control, by using the remote control lever.

How to adjust the speed

To set the ship's speed, move the SUZUKI control lever to Forward ([F]) or to Reverse ([R]). After moving the control lever, speed control starts again and the SETSPD stops blinking.

How to stop the speed control adjustment

1. Short press  to open the menu.
2. Select [Speed Control OFF] and press .
After the setting, blue SPD icon in the upper right corner of the screen changes to grey.

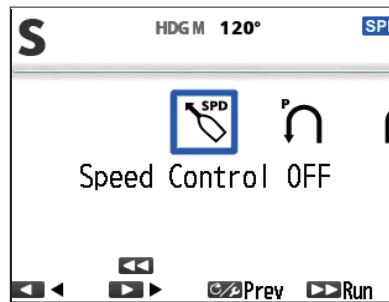

By long pressing , the setting is available.

How to stop the speed control adjustment from the SUZUKI control lever

You can stop the speed control adjustment by moving the control lever to Neutral ([N]). After the speed control stops, the autopilot mode is automatically set to the STBY mode. To resume speed control, refer to "How to start the speed control" on page 2-26.

2.11.2 Deceleration during NAV mode

Decelerate when changing routes, arriving at the final waypoint, or when switching to Point Lock (after reaching the final waypoint). PGN129285 must be output from the chart plotter to use this function.

How to decelerate before turning

When [Route Smoothing] is set to [ON], the ship automatically decelerates when arriving at the final waypoint in the NAV mode and automatically re-accelerates after turning. Ship speed after deceleration is shown on the screen.

This function works under the following conditions.

- [Speed Control ON] is active and SETSPD is not blinking.
- The turning angle of the route is 60° or more.
- The current ship speed is equal to or higher than the ship speed set in [Auto Pilot Option]-[Low Speed Limit].
- At least 15 seconds have passed after returning from each mode of Dodge, Safe-Helm, or PowerAssist.

2. STEERING MODES

Note: Keep the following in mind when using this function:

- When the remote control lever is operated during deceleration control, the deceleration function is released and the ship accelerates to the speed set with the lever.
- When the Dodge/SafeHelm/PowerAssist mode is selected during deceleration control, the ship's speed at that time is maintained. When returning to the NAV mode, the ship accelerates to the original ship's speed.
- Even if this function is turned ON, deceleration is not available at the final waypoint. If you want to decelerate at the final waypoint, see "Notes on arrival at final waypoint" below.

1. Long press  to open the menu.
2. Select [Auto Pilot Option].
3. Set [Route Smoothing] to [ON].

How to adjust the ship's speed during turns

Follow the below procedure to adjust the ship's speed when turning.

1. Long press  to open the menu.
2. Select [Auto Pilot Option].
3. To change the deceleration rate on turning, set [Deceleration Rate] to [Medium], [High] or [Low].

Note: The factory default is [Medium]. Set to [High] when the vessel speed is too fast when turning, or [Low] when it is too slow.

Notes on arrival at final waypoint

Note 1: When using this function with the SUZUKI control lever in the dual mode, set the left and right levers to the same position. When the left and right lever positions are not in the same position, automatic deceleration is unavailable when arriving near the final waypoint.

Note 2: When using FantumFeedback™, the Point Lock™ mode is not available. The [On Arrival] shows the [Auto Stop] instead of the [Point Lock]. Select [Auto Stop] to slow down when you arrive at your final waypoint, but transition to the STBY mode instead of the Point Lock™ mode.

Note 3: When [On Arrival] is set to [Point Lock], the ship will decelerate when arriving near the final waypoint even if [Route] - [End of route Operation] is set to [Continue Navigation] on the chart plotter.

Note 4: Set the waypoint switching method on the chart plotter: [WPT Switch Mode] → [Circle and Cross Line] or [Cross Line].

Note 5: When switching to the Point Lock™ mode after arriving at final waypoint, a message announces the return to the NAV mode. Read the message, then press the said key to erase the message. Note that heading deviation continues even if the message is not erased.

1. Long press  to open the menu.
2. Select [Auto Pilot Option].

3. Set [On Arrival] to [Point Lock] or [Auto Stop] (When using Fantum Feedback™).

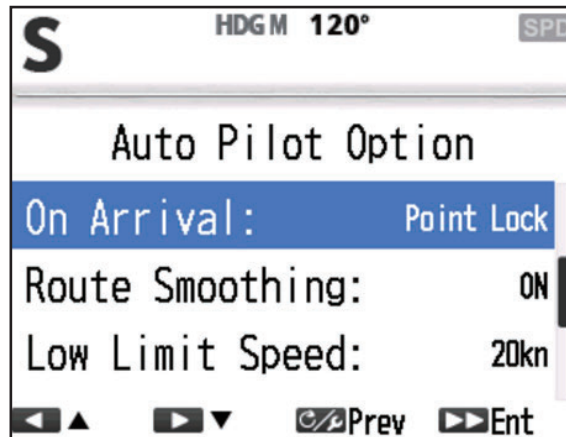

When set to [Point Lock], deceleration starts automatically after arriving near the final waypoint and the green ENG icon appears in the upper right corner of the NAVpilot-300 screen. When set to [Auto Stop], the ship's speed slows down at the final waypoint, but transitions to the STBY mode instead of Point Lock.

Note 1: Deceleration at the final waypoint starts even when [Speed Control] is set to [OFF].

Note 2: If the remote control lever is shifted to the [R] position during automatic deceleration, the engine speed is reduced to the speed set with the remote control lever immediately. If the remote control lever is at the [N] position and then returned to [F] or [R], the deceleration is interrupted.

2.11.3 Point Lock™

Point Lock™ holds the vessel in a set position, preventing the ship from being swept away while stopped. Observe the following remarks on Point Lock™ operation.

Note 1: Point Lock™ is not available when using FantumFeedback™.

Note 2: Before using this function, orient the stern in a windward direction to stop the ship and set the remote control lever to the [N] position.

Note 3: This function cannot change the setting course or holding position. To change the holding position, return to the STBY mode then start this function.

Note 4: A warning message appears when switching to Point Lock™. Read the message, then press said key to erase the message. The heading deviation continues even if the warning message remains on the display.

Note 5: The GPS sensor must be located in an unobstructed environment.

Note 6: Observe the following points.



- Keep at least five boat's lengths away from structures.
- Use only in sea conditions where the direction of the wind and the direction the ship is being swept are the same.

Note 7: An alarm will occur in sea conditions where Point Lock™ is not recommended. Press  once to confirm if the conditions are acceptable to use.

2. STEERING MODES

Note 8: The Point Lock™ will stop when the alarm for no heading, no ship's position, or Point Lock range circle is exceeded. Press  once to acknowledge.

How to start the Point Lock

1. Short press  to open the menu.
2. Select [Point Lock] and press .



How to adjust the strength of the pull to the center point

1. Long press  during the Point Lock™.



2. Change values on [Sensitivity] as below.

When the ship moves away from the center point of the control unit.	Decrease the [Sensitivity] value.
When the shift F / R is switched frequently.	Increase the [Sensitivity] value.
When the shift shock is heavy	

How to stop the Point Lock

From the Control Unit: Short press  to finish the Point Lock™.

From the remote control lever: Operate the lever to shift from [N] to [F] or [R].

When the Point Lock™ starts after stopping at the final waypoint in the NAV mode, set the remote control lever to the [N] position to stop the Point Lock™ and transition to the STBY mode.

2.11.4 SABIKI Lock™



SABIKI Lock™ adds throttle operation automation to the SABIKI™ mode (see section 2.6).

Note 1: A warning message appears when switching to SABIKI Lock™. Read the message, then press the said key to erase the message. The deviation continues even if the message remains on the screen.

Note 2: Before using this function, orient the stern in a windward direction to stop the ship and set the remote control lever to the [N] position.



Note 3: It is not recommended to use this function when the wind speed is 2 m/s or less, because the ship will continue to move toward the stern and the fishing line will flow toward the bow.

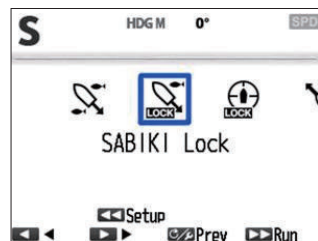

How to start the SABIKI Lock

1. Short press  to open the menu.
2. Select [SABIKI Lock] and press .



How to change the set course

While in the Auto SABIKI™ mode, short press  to change the course to 1° to starboard side, and short press the  to change course to 1° to port side.

Short press  to change the course to 10° to starboard side, and short press  to change course to 10° to port side.

How to adjust the SABIKI Lock

Note: When any of the following cases occur, adjust [Sensitivity].

When the SABIKI™ mode over-corrects the direction.	Decrease the [Sensitivity] value.
If the direction is under-corrected.	
When the SABIKI™ mode under-corrects direction.	Increase the [Sensitivity] value.
If the direction is over-corrected.	

2. STEERING MODES

1. Long press  during the Sabiki Lock™.



2. Change values on [Sensitivity] as below.

How to stop the SABIKI Lock

From the Control Unit: Short press  to finish the SABIKI Lock™.

From the remote control lever: Operate the lever from N to F or R to stop the Point Lock™.

3. ALERTS

Your NAVpilot has two types of alerts: Watch Alert and Deviation Alert.

When the alert conditions are violated, the buzzer sounds, the alert icon () flashes and a pop-up message appears (see section 6.6.3). Press any key to silence the buzzer and close the pop-up window. The icon flashes until the cause of the alert is rectified. If the alert condition are still violated after one minute, the buzzer sounds and the pop-up message appears again.

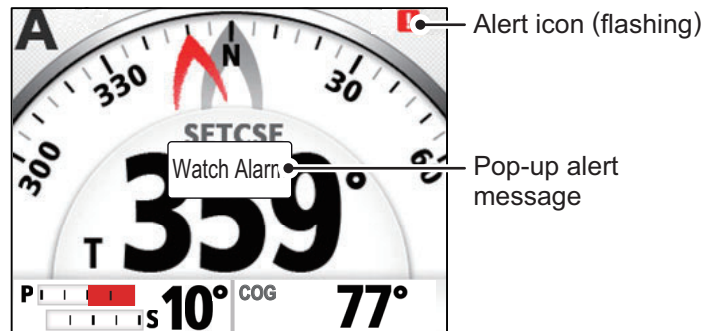

You can check which alerts are currently violated (see section 3.4) and alerts which have occurred previously (see section 3.5).

Note 1: If an alert occurs, switch to STBY mode and operate the vessel from the helm.

Note 2: If an alert occurs, the FAP-3011 releases an audible alert and displays an alert message. If the GC-001 is turned on, the GC-001 also releases an audible alert and shows an alert message (see section 5.5). The audible alert and alert message must be acknowledged individually for both the GC-001 and the FAP-3011.

Alert priority

Alerts have three priority levels: [Alarm], [Warning] and [Caution].

- Alarm: Situations or conditions which require immediate attention, decision and (if necessary) action by the crew to avoid any kind of hazardous situation and to maintain the safe navigation of the ship.
- Warning: Conditions or situations which require immediate attention for precautionary reasons, to make the crew aware of conditions which are not immediately hazardous, but may become so.
- Caution: Informs you of a condition which continues to require attention out of the ordinary consideration of the situation or of given information.

Depending on the alert priority, the alert buzzer also changes, as shown in the table below.

Alert Priority	Buzzer sound
Alarm	Continuous
Warning	Long beeps with a short silent interval
Caution	Short sharp beeps

Note 1: If multiple alerts are active, the alert with the highest priority is shown as a pop-up message. See section 6.6.3 for messages and their priority.

Note 2: If the alert is Alarm priority, the Alarm icon (**ALARM**) flashes at the top-left corner of the screen.

3.1 How to Show the Alert Menu

To show the Alert menu, do the following procedure.

1. Open the menu.
2. Select [Other Menu].
3. Select [Alert]. The [Alert] menu appears.

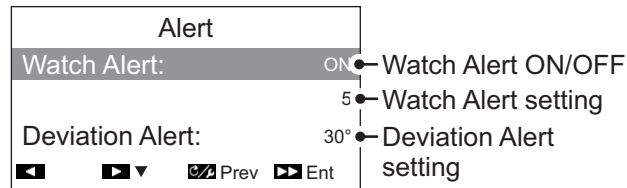

3.2 How to Set the Watch Alert

The watch alert periodically warns the helmsman to check the NAVpilot when in the AUTO or NAV mode.

1. Referring to section 3.1, open the [Alert] menu.
2. Select [Watch Alert].
3. Select [ON] or [OFF] as appropriate. For the purpose of this example, select [ON]. The Watch Alert setting value becomes selectable.
4. Select the [Watch Alert] setting.
5. Set the appropriate time for the watch alert to release a warning beep. The setting range is 1 to 99 (minutes) and the default setting is 5 (minutes).
6. Close the menu.

If the NAVpilot is not operated within the time set for the watch alert, the watch alert op-up message appears and the buzzer sounds. If there is no operation for a further 10 minutes, the alert sound becomes louder.

To disable the watch alert, select [OFF] at step 3 in the above procedure.

3.3 How to Set the Deviation Alert

In AUTO and NAV modes, the deviation alert sounds the buzzer and shows a pop-up message when the heading deviates more than the deviation alert value.

Note 1: The setting value of the deviation alert can be changed, but you cannot deactivate this alert.

Note 2: When the autopilot cannot move the rudder with Fantum Feedback™, the deviation alert sounds regardless of the setting value. In this case, switch to the STBY mode and turn the helm to move the rudder.

1. Referring to section 3.1, open the [Alert] menu.



2. Select [Deviation Alert].
3. Set the desired value for deviation. The setting range is 1° to 90° and the default setting is 30°.
4. Close the menu.

3.4 How to View the Alert Messages

Active alerts are listed as messages. You can view active alerts at any time by following the procedure below.

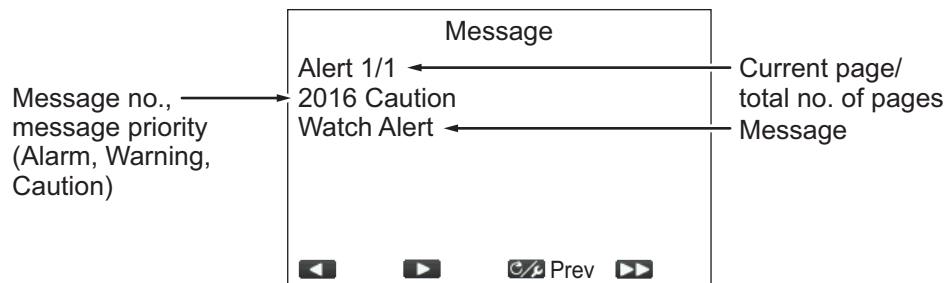
1. In STBY, AUTO, NAV or OVRD mode, open the menu.
For Safe Helm mode, press  to show the [Turn] menu, then select [Menu].
2. Select [Message]. The active alerts appear. The list shows the message number, the total number of messages, alert code and name and the alert priority (Alarm, Warning or Caution).



Where there is more than one page of alerts, press  or  to change pages.

3. Close the menu.

3.5 How to Show the Alert Log

The [Alert Log] shows the type, date, time and alert no. of up to 10 previous alerts. To show the [Alert Log], follow the procedure below.

1. In STBY, AUTO, NAV or OVRD mode, open the menu.
For Safe Helm mode, press  to show the [Turn] menu, then select [Menu].
2. Select [Other Menu].
3. Select [System Setup].
4. Select [Alert Log]. The [Alert Log] appears.

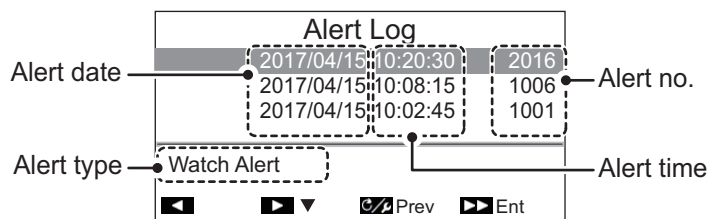

5. Close the menu.

3. ALERTS

This page is intentionally left blank.

4. HOW TO CUSTOMIZE YOUR NAVPILOT

This chapter shows you how to customize your NAVpilot to suit the characteristics of your boat and your operational needs. The items shown in each menu depend on the mode in use.

4.1 How to Setup the Parameters

There are two methods for parameter setup; automatic setup and manual setup.

4.1.1 Automatic parameter setup

The NAVpilot-300 can automatically setup its operating parameters based on your own ship characteristics and sea conditions. The system also has the ability to store past parameters, thanks to the [Self Learning] feature.

1. Open the menu.
2. Select [Self Learning].
3. Select [ON] or [OFF] as appropriate.
 - [ON]: Self Learning is enabled. The system monitors and records ship characteristics and parameters such as rudder angle, trim, etc from the moment you depart until you return to the dock.
 - [OFF]: Self Learning is not enabled.

If you select [ON], proceed to the next step of this procedure.

If you select [OFF], close the menu.

4. Select [Deviation Level]. The deviation level sets the threshold for heading adjustments made by the system. When [Self Learning] is set to [OFF], this menu item is not available for selection.
5. Select [Auto] or [Level], as appropriate.
 - [Auto]: The system automatically adjusts heading, regardless of how minor the deviation may be.
 - [Level]: Sets the threshold at which the system corrects heading.

If you select [Auto], close the menu.

If you select [Level], proceed to the next step of this procedure.

6. Select the [Level] value. A settings popup window appears.
7. Set the [Level].

A low setting regularly adjusts the rudder in order to keep a consistent heading.
A higher settings reduces the regularity at which the rudder is adjusted, however heading is not consistent.
8. Close the menu.

4.1.2 Manual parameter setup

To setup the parameters, follow the procedure below.

Note: This procedure requires [Self Learning] to set to [OFF].

1. Open the menu.
2. Select [Manual Parameters]. The [Manual Parameters] menu appears.

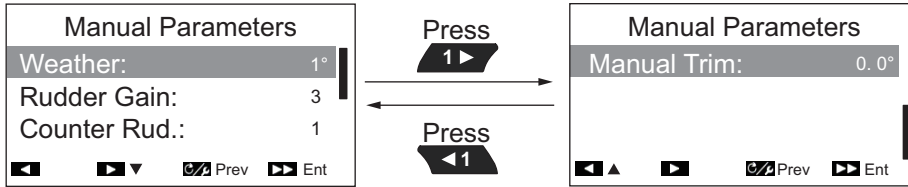

3. Select [Weather]. The weather setting popup appears.

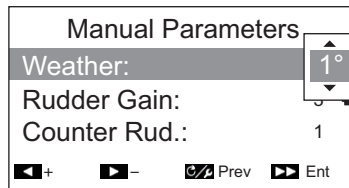

4. Set the [Weather] parameter as required. The setting range is 1° to 10° and the default setting is 1°.

When the sea is rough, the boat's heading fluctuates to port and starboard. If the rudder is driven very often to maintain the set course, the helm mechanism may wear out. To prevent this, the weather adjustment makes the NAVpilot insensitive to minute course deviations.

The illustration below shows boat's track lines with weather setting 3° and 7°. When 7° is set, for example, the rudder is not driven until the course deviation exceeds 7°. Increasing the setting reduces activation of the steering gear, however the boat tends to zigzag. When the sea is calm, set a smaller value.

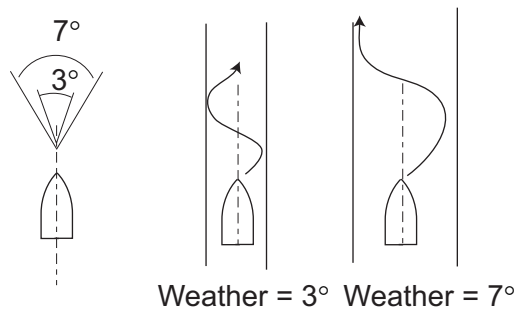

5. Select [Rudder Gain]. The rudder gain setting popup appears.

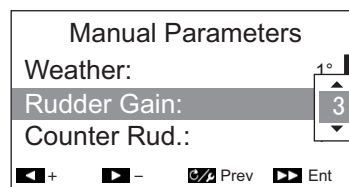

6. Set the rudder gain (sensitivity). The setting range is 1 to 20 and the default is 3. When the boat's heading deviates from the set course, the NAVpilot adjusts the rudder to correct it. The rudder angle (number of degrees) which is steered against every degree of course deviation is known as the rudder gain.

Set rudder gain so that the boat does not make frequent yaw. The figure shown below provides general guidelines for setting rudder gain.

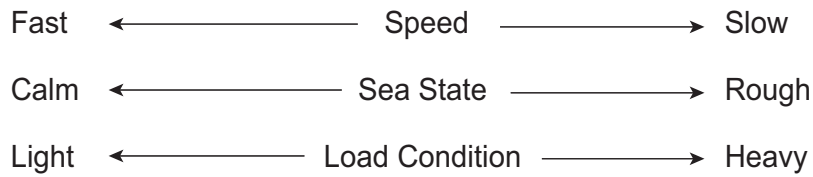

7. Select [Counter Rud.]. The counter rudder setting popup appears.

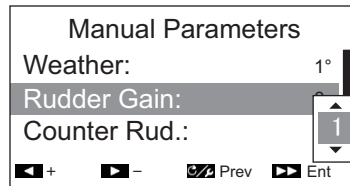

8. Set the counter rudder as required. The setting range is 0 to 20 and the default setting is 1.
 If the boat is heavily loaded, the heading could change excessively because of inertia. This phenomenon causes the boat to "overshoot" the intended course. If this happens, the NAVpilot will steer the rudder to the opposite side and the heading will turn in opposite direction excessively again. In an extreme case the heading oscillates several times until it finally settles in the new course. An adjustment known as "counter rudder" prevents this kind of oscillation.
 Counter rudder is usually not required for small boats. When your boat zigzags a lot before settling in the new course, increase the counter rudder setting.

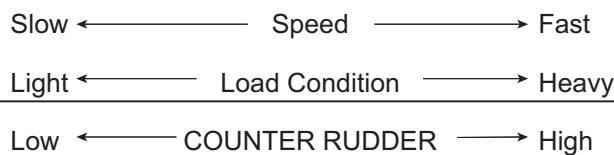
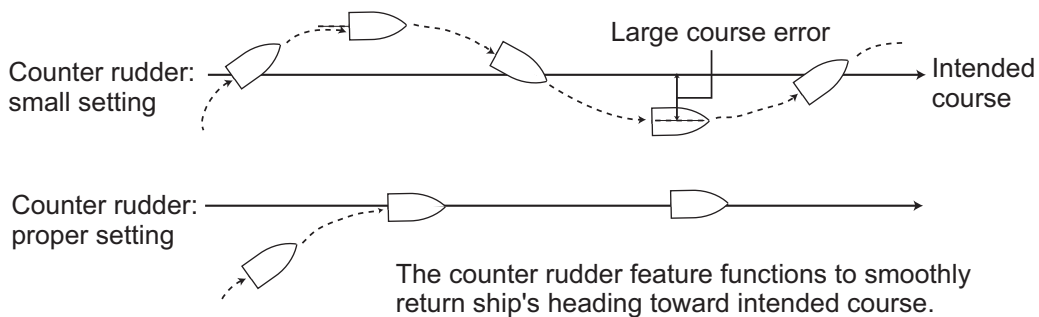

9. Select [Manual Trim]. The manual trim setting popup appears.

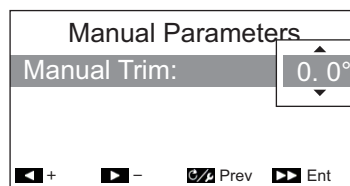

4. HOW TO CUSTOMIZE YOUR NAVPILOT

10. Set the trim as required. The setting range is P5.0° to S5.0°, and the default setting is 0.0°.

This setting compensates for yaw caused by rough seas or heavy loads. If the boat has a port-side yaw, adjust the trim to starboard. Alternatively, if the boat has a starboard-side yaw, adjust the trim to port.

Note: For boats with Fantum Feedback™, [Manual Trim] settings are not used. The menu item is available, however any change in settings is ignored.

11. Close the menu.

4.1.3 Speed calculation

Speed is normally entered automatically, from your navigator. If the navigator fails, manually enter the speed by following the procedure below.

1. Open the menu.
2. Select [Speed Calculation].
3. Select [AUTO] or [MANUAL], as appropriate. For [AUTO] go to step 4. For [MANUAL], do as follows:
 - 1) Select the current value.
 - 2) Set a value. The setting range is 0.1 to 40.0 knots and the default setting is 30.0 knots.
4. Close the menu.

4.2 Rudder Drive Level (For Fantum Feedback™)

For Fantum Feedback™, the driving power of steering can be adjusted by the rudder drive level. The higher the setting, the greater the rudder is turned.

1. Open the menu.
2. Select [Rudder Drive Level].
3. Set the required value. The setting range is 1 to 20. The default setting depends on whether a rudder test is completed beforehand. Where the rudder test is complete: the default is the test result; where the rudder test is not complete: the default setting is 6.
4. Close the menu.

4.3 Nav Data Source

This section covers how to select the source of nav data to use in the NAV mode.

1. Open the menu.
2. **If NAV mode is active**, select [NAV Data Source].
If any mode other than NAV mode is active, select [Other Menu] → [Auto Pilot Options] → [NAV Data Source].
 A list of navigational devices connected to the same NMEA2000 network appears. For the purpose of this example, the list shows a TZTL12F.

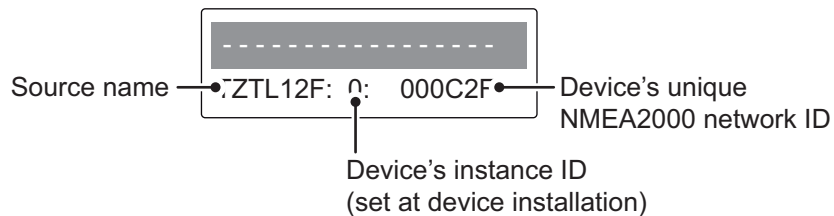

If your NMEA2000 network has more than one device capable of nav data output, those devices are also listed. Each device is shown with its unique instance ID and network ID. The instance ID is set when the device is first installed as part of the NMEA2000 network. The network ID is unique to each device.

3. Select the appropriate device to use for nav data input to your NAVpilot-300.
4. Close the menu.



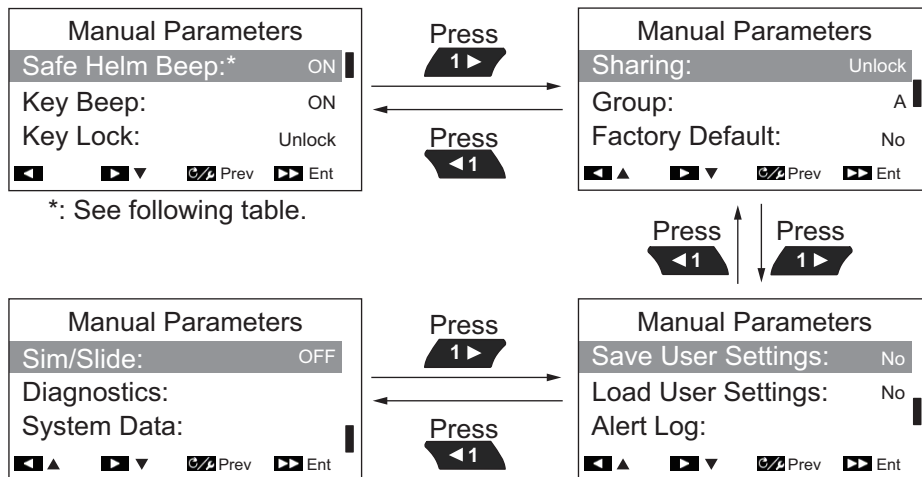

4.4 System Setup Menu

The [System Setup] menu provides various functions which once set do not require frequent adjustment. Set the items in this menu according to operational needs, current environment, etc. To open this menu, select [OTHER MENU] followed by [SYSTEM SETUP].



The following table lists the menu items in the [System Setup] menu, along with a brief description for each item.

4. HOW TO CUSTOMIZE YOUR NAVPILOT

Menu item	Description
[Safe Helm Beep]	<p>Selects whether to sound a “beep” when OVRD mode is activated. Select [OFF] for no “beep”, [ON] to sound a “beep”.</p> <p>Note: This menu item appears under the following conditions:</p> <ul style="list-style-type: none"> [Boat Type] is set to [EVCS-Pod Drive], [EVCS-Outboard], [EVCS-Inboard] or [EVCS-In/Out] at installation. EVCS is DOMETIC OPTIMUS.
[Key Beep]	<p>When a key is pressed the system can release a beep sound.</p> <p>[ON]: Key-press makes a beep sound; [OFF]: No sound on key-press.</p>
[Key Lock]	<p>Activates or deactivates the key lock for the control unit.</p> <ul style="list-style-type: none"> [Lock]: Keys are locked. When any key, other than , is pressed, the message shown to the right appears. The lock icon () also appears. <div data-bbox="1075 555 1385 703" style="border: 1px solid black; padding: 5px; margin: 10px 0;"> <p>This controller is locked.</p> <p>To unlock, hold [menu] key down and press [10>>] key.</p> </div> <p>To unlock the controls, press and hold , then press .</p> <p>If the system is turned of with the key lock activated, when the system is turned on next, the key lock will be active.</p> <ul style="list-style-type: none"> [Unlock]: Keys are not locked.
[Sharing]	<p>The following installation settings can be shared and passed onto the sub units on the same network: [Sensor in Use], [Units Setup], [Heading Display], [Time Offset], [Mag. Var.], [STW Adjust]. The unit assign as [Master] shares its settings with units assigned as [Sub].</p> <p>Select the appropriate sharing level from the following options.</p> <ul style="list-style-type: none"> [Stand Alone]: Disables sharing of settings. [Sub]: Assign the control unit as a sub unit. [Master]: This unit’s settings are passed to all sub units. Where a FURUNO multi function display (MFD) is in the same network, the MFD is automatically assigned as the [Master] and this option is not available.
[Group]	<p>The language and brilliance settings are shared within a group of NAVpilot-300 control units and FI-70s. If the settings are adjusted for one control unit or FI-70 in the group, all other units in the same group are also adjusted, however MFD settings are not adjusted. There are three groupings available: [A], [B] and [C]. Select an appropriate group to assign a group to a control unit.</p>
[Factory Default]	<p>Select [Yes] to restore factory default settings. The system is automatically restarted after selecting [Yes].</p>
[Save User Settings]	<p>Select [Yes] to save the current settings as user default settings to the internal memory. The user default settings in the internal memory are overwritten with the current settings.</p>
[Load User Settings]	<p>Select [Yes] to load the setting data from the internal memory. The current settings will be overwritten with the user default settings in the internal memory.</p>
[Alert Log]	<p>You can see which alert(s) has, or have been violated. A maximum of 10 alerts are listed. When the capacity is exceeded, the oldest alert is deleted to make a room for the latest.</p>
[Sim/Slide]	<p>Activate or deactivate the demonstration mode. DO NOT select any option other than [OFF] on board your boat. Options other than [OFF] are intended for promotional use.</p>
[Diagnostics]	<p>Perform various diagnostics on the NAVpilot system. Available in the STBY mode only. For details, see section 6.4.</p>

Menu item	Description
[System Data]	Shows system data. <ul style="list-style-type: none"> [Input Voltage]: Voltage input to the NAVpilot. [Drive Unit]*: Drive type used with the NAVpilot. [FET Temp.]: Temperature of the circuit board in the processor unit. [Motor Drive Cur]*: Motor drive current. *: Not shown for the EVC system equipped vessel.

4.5 How to Open the NMEA2000 Sensor Menu

The NAVpilot can access and setup compatible NMEA2000 sensors which are on the same network. Calibrations and offsets applied in this menu are also applied to the sensor itself.

To access the sensor's menus and settings, do as follows:

1. Turn on the sensor to set up.
2. In the STBY mode, press and hold the  key, then press the  key three times.

The [Device Settings] menu appears. Sensors that can be set up from the NAVpilot are shown on the [Device Settings] menu.

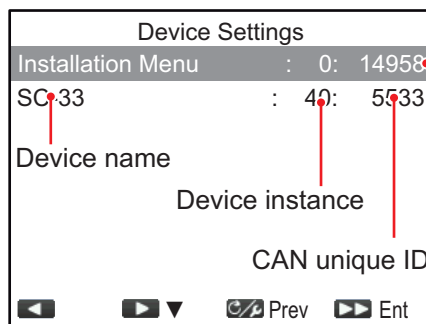

For details about [Installation Menu], see the installation manual.

Note: When the sensor that can be set up from the NAVpilot is not connected in the same NMEA2000 network, [Installation Menu] appears instead of the [Device Settings] menu.

3. Select the sensor to set up.
The following message is shown while loading the menu from the sensor.

Receiving data. . . please wait.

The sensor setting menu appears after loading the menu.

4. Adjust each setting item, referring to the operators manual of the sensor.

4. HOW TO CUSTOMIZE YOUR NAVPILOT

This page is intentionally left blank.

5. GESTURE CONTROLLER GC-001

Note: With regards to safety and handling instructions for your GC-001, see the User Guide included with the GC-001.

5.1 Gesture Controller GC-001 Overview

Depending on the NAVpilot-300's operating mode, the function of most keys on your GC-001 changes. For detailed information regarding key operation, see section 5.9.

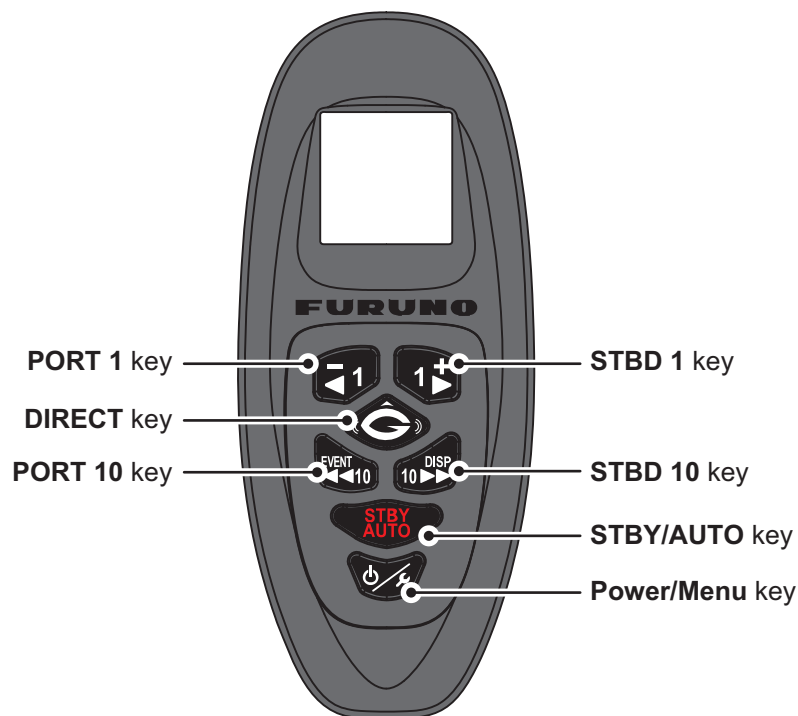

5.2 How to Turn the Power On/Off

Turning the power on

Press and hold  to turn the power on. The GC-001 beeps, then shows the start-up screen. A self-diagnostic test begins and the program numbers for the GC-001 appear, followed by test results for ROM, RAM and backup.

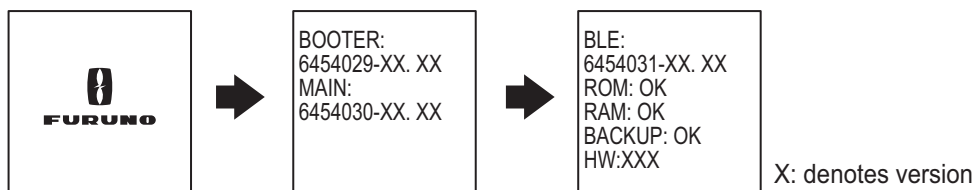

When all test results show "OK", the GC-001 attempts to connect to the paired NAVpilot-300. When the GC-001 connection to the NAVpilot-300 is complete, the main screen appears and you can use the GC-001 to remotely control the NAVpilot-300.

See section 5.8 to pair other GC-001 controllers with your NAVpilot-300.

Note 1: If NG appears for any of the self-diagnostic tests, the start up process is stopped. Turn the power off, remove the batteries from the GC-001 and consult your local dealer.

Note 2: Software updates are automatically started when required and start after the start up process is complete.

Turning the power off

Press and hold  to turn the power off. A message and countdown timer appear on the GC-001 display. When the countdown is complete, the remote control turns off.

Note: Where [Auto OFF] is set to other than [OFF], if there is no operation within the set time period, the GC-001 automatically turns off. See section 5.6.6 for details.

5.3 Display Overview

The figure below shows an overview of the GC-001 display in STBY mode. The GC-001 display changes depending on the mode in use by the NAVpilot-300.

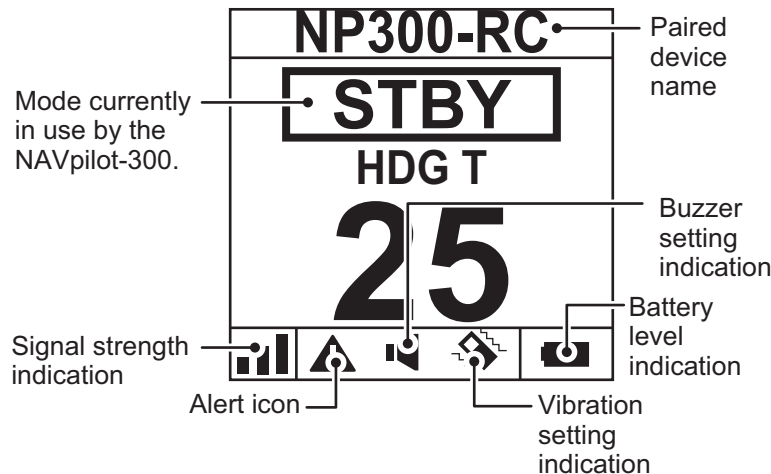

Note 1: Signal strength is indicated as one of four levels, as listed in the table below. Distance from the processor unit, obstructions and battery voltage can reduce the signal strength. Check the signal strength when operating the GC-001.

Signal strength indication	Strength level
No solid bars (□□□)	Signal is extremely weak or unavailable. Move closer to the processor unit.
One solid bar (■□□)	Signal is available, but weak. Some features and functions may not work as intended.
Two solid bars (■■□)	Signal is average strength.
Three solid bars (■■■)	Signal is strong.

Note 2: When the battery level is less than 10%, the GC-001 releases an alert (see section 5.5). Low battery level can affect screen visibility and remote control functions. To replace the batteries, see the User Guide included with the GC-001.

5.4 GC-001 Menu Overview

The GC-001 has a main menu which contains two types of menus.

- [TURN] menu: Consists mainly of shortcuts for FishHunter™ turns.
- [SYSTEM MENU]: contains setup menus for your GC-001. Once setup, these settings do not require regular adjustment.

To access the menu, follow the procedure below.

1. Press . The [TURN] menu appears. The first time the menu is displayed after the power is turned on, [SABIKI] is highlighted. If a different menu item is selected while the power is still on, the last-used menu item is selected.
2. Press , , or to navigate the menu. The menu cycles in the direction of the button pressed, as shown in the example figure below.

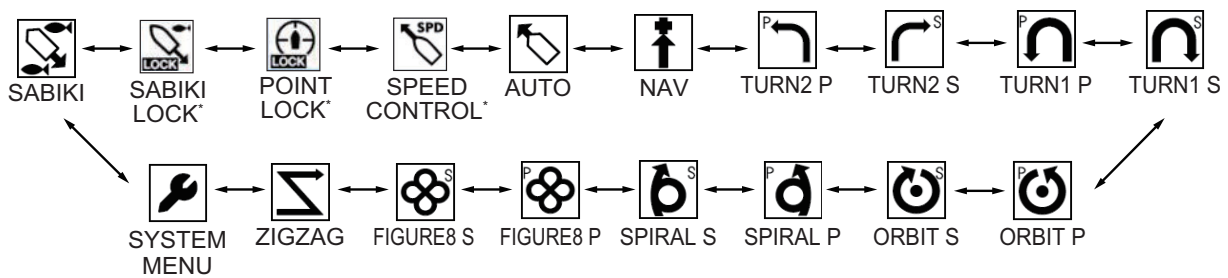

* : Available only with the outboard by SUZUKI MOTOR CO., LTD.

The selected item is shown in the center of the screen as shown in the figure below.

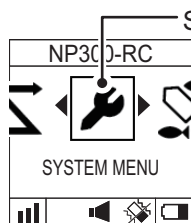

Note: If the GC-001 is not paired with the NAVpilot-300, the menu icons are not shown. To pair the GC-001, see section 5.8.

3. Press to confirm your selection.



If a menu item other than [SYSTEM MENU] is selected, the message "CHANGING MODE" appears on the NAVpilot-300 screen to inform you that the mode is changed.

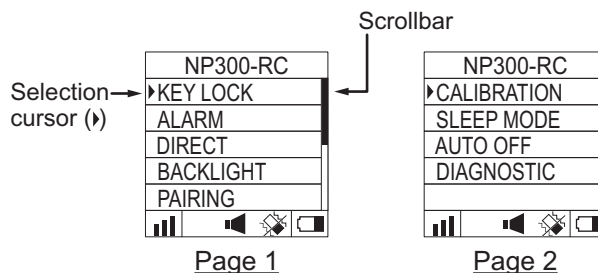

For details about how to use your GC-001 with each NAVpilot-300 mode, see section 5.9.



If [SYSTEM MENU] is selected, the [SYSTEM MENU] appears.





For details about the [SYSTEM MENU], see section 5.6.

- In the [SYSTEM MENU], press  or  to select a menu item, then press  to confirm the selection. For the purpose of this example, select [KEY LOCK].

The selection cursor shown the current selection. Press  to move the cursor upwards, or press  to move the cursor downwards. The scrollbar appears when there are menu items which are not visible on the screen.

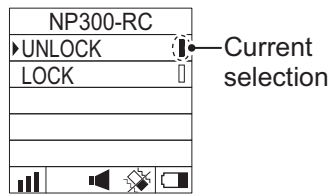
- Press  or  to select a menu option, then press  to apply the change. Current settings are indicated with a solid bar (█). The example figure below shows the [KEY LOCK] settings.



- Press  several times to close the menu.

Note: For the sake of brevity, menu operations within this chapter use the phrase “Select xxxx.” to describe menu selection.

5.5 GC-001 Alerts

Alerts are displayed on the GC-001 screen in the following circumstances:

- The GC-001 generates an alert.
- The GC-001 receives an alert generated by the processor unit.

Depending on your settings, the buzzer sounds and the GC-001 vibrates to inform you of an alert. Press any key to silence the buzzer and stop the vibration; the alert messages shown on the GC-001 and the NAVpilot-300 are also closed.

When the GC-001 detects an alert condition, the alert icon remains until the reason for the alert is removed. If the alert cause is present after three minutes, the alert buzzer sounds again and the alert message reappears.

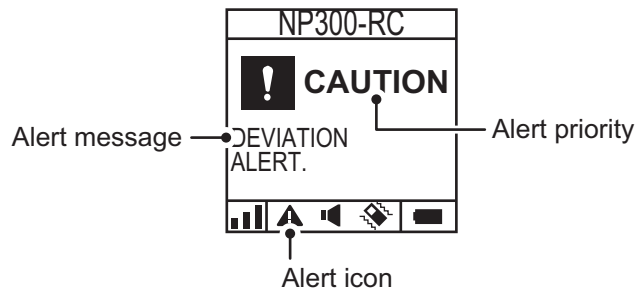

5.5.1 Alert priority

There are three levels of alert priority: [Alarm], [Warning] and [Caution] (see chapter 3). If there is more than one alert active, the highest priority alert is displayed. If an alert generated by the GC-001 is active at the same time as an alert received from the processor unit, the GC-001 alert is displayed.

5.5.2 Alert list

Alerts generated by the GC-001

The table below lists all alerts generated by the GC-001, along with their meaning, alert level, priority in which they are displayed and possible remedy.

Display Priority	Message	Meaning/remedy
Alert level: Alarm		
1	LOW BATTERY	Remaining battery voltage is lower than 10%. Replace the batteries referring to the User Guide included with the GC-001.
2	COMM ERROR	There is a communication problem between the GC-001 and the processor unit. Check that the processor unit is turned on.

Alerts received from the processor unit

The table below list all alerts which can be received from the processor unit, along with the priority in which they are displayed and the corresponding alert message which appears on the NAVpilot-300. For details regarding the meaning and remedy for these alerts, see section 6.6.3. Error codes 0001 and 1003 are not displayed on the GC-001.

Display Priority	GC-001 Message	Processor unit error code and message
Alert level: Alarm		
1	DRIVE UNIT MALFUCTION. TURN SYSTEM OFF.	Error code: 0002 "Drive unit malfunction. Check the drive circuit."
2	DRIVE UNIT IS OVERLOADED. TURN SYSTEM OFF.	Error code: 0003 "Drive unit is overloaded. Check the drive circuit."
3	DRIVE UNIT IS OVERHEATED. TURN SYSTEM OFF.	Error code: 0004 "Drive unit is overheated. Check the drive circuit."
4	RUDDER DRIVE MALFUCTION. TURN SYSTEM OFF.	Error code: 0005 "Rudder drive malfunction. Check the drive circuit."
5	RUDDER ANGLE ERROR. TURN SYSTEM OFF.	Error code: 0006 "Rudder angle error. Check the drive circuit."
6	ENGINE ALARM CHECK ENGINE STATUS.	Error code: 0007 "BCM error. Check the error information at the BCM"
7	THROTTLE ALARM CHECK THROTTLE SYSTEM.	Error code: 0008 "Lever error. Check the error information at the BCM."
8	GATEWAY ERROR CHECK GATEWAY	Error code: 0009 "GATEWAY Disconnected. Check the connections with the GATE- WAY."
9	COMMUNICATION ERROR WITH ENGINE.	Error code: 0010 "Engine control authorization er- ror.Check the error information at the BCM."
10	GATEWAY COM ERROR RESTART NAVPILOT	Error code: 0011 "Authorization error. Check the connections with the GATE- WAY, then restart the NAVpilot-300."
Alert level: Warning		
11	REDUCE SPEED FOR SABIKI (<5KN).	Error code: 1001 "Reduce speed for SABIKI (<5kn)"
12	COMMUNICATION ERROR WITH EVC SYSTEM.	Error code: 1002 "Communication error with EVC sys- tem."
13	NO HEADING DATA AVAILABLE.	Error code: 1004 "No heading data available."

Display Priority	GC-001 Message	Processor unit error code and message
14	SUDDEN CHANGE IN HEADING DATA.	Error code: 1005 "Sudden change in heading data."
15	RATE SENSOR ERROR.	Error code: 1006 "Rate sensor error."
16	INITIALIZING HEADING SENSOR.	Error code: 1013 "Initializing heading sensor. This takes two minutes, please wait."
17	THROTTLE ERROR SYNCHRONIZE BOTH THROTTLE POS.	Error code: 1016 "Throttle levers not aligned. Make sure both throttle levers are at the same position."
18	NO SPEED DATA AVAILABLE.	Error code: 1007 "No speed data available. Check speed source or enter manual speed value in Parameter Setup."
19	NO NAV DATA AVAILABLE.	Error code: 1008 "No NAV data available."
20	NAV DATA QUALITY DEGRADED.	Error code: 1009 "NAV data quality degraded."
21	NO POSITION DATA AVAILABLE.	Error code: 1010 "No position data available."
22	TOO FAST TO FOR THIS MODE.	Error code: 1011 "Too fast for this mode. Reduce speed to less than 10 knots."
23	BACKUP DATA ERROR.	Error code: 1012 "Backup data error."
Alert level: Caution		
24	NO THROTTLE OPERATION RETURN TO NEUTRAL.	Error code: 2018 "Throttle operation error. Set the throttle to neutral."
25	WIND/WAVE FORCE EXCEEDED STOP POINT LOCK	Error code: 2019 "Point Lock is not available. Point Lock mode is not available due to wind and current."
26	POINT EXCEEDED STOP POINT LOCK RETURN TO STBY.	Error code: 2020 "Distance to fixed point is too far. Point Lock mode has stopped, set to STBY mode."
27	INPUT VOLTAGE IS TOO LOW.	Error code: 2001 "Input voltage is too low."
28	INPUT VOLTAGE IS TOO HIGH.	Error code: 2002 "Input voltage is too high."
29	ERROR IN NAV MODE PARAMETERS. CHANGE MODES.	Error code: 2003 "Error in NAV mode parameters. Change modes."
30	WIND/WAVE FORCE EXCEEDED ADJUST ENG RPM.	Error code: 2021 "Speed control affected by external conditions. Adjust the throttle accordingly. Use caution as vessel speed may change abruptly."
31	COMPASS SETTINGS INCOMPLETE.	Error code: 2004 "Compass settings incomplete. Set compass calibration from menu."

5. GESTURE CONTROLLER GC-001

Display Priority	GC-001 Message	Processor unit error code and message
32	HEADING SOURCE CHANGED.	Error code: 2005 "Heading source changed. Compass settings incomplete. Set compass calibration from menu."
33	EVC OVERRIDE.	Error code: 2008 "EVC Override."
34	ARRIVED AT FINAL WAYPOINT.	Error code: 2009 "Arrived at final waypoint."
35	WAYPOINT WAS UPDATED.	Error code: 2010 "Waypoint was updated."
36	FISH HUNTER MODE ACTIVATED.	Error code: 2011 "Fish Hunter mode activated."
37	WATCH ALERT.	Error code: 2013 "Watch Alert!"
38	POSITION SOURCE CHANGED.	Error code: 2006 "Position source changed."
39	Speed SOURCE CHANGED.	Error code: 2007 "Speed source changed."
40	NAV MODE COMPLETE. SWITCHING MODES.	Error code: 2014 "NAV mode complete. Switching modes."
41	HELM SENSOR ERROR.	Error code: 2017 "Helm sensor error."
42	DEVIATION ALERT.	Error code: 2015 "Deviation alert."
43	WATCH ALERT.	Error code: 2016 "Watch Alert!"
44	TOO SLOW INCREASE SPEED IN 5 - 49KN.	Error code: 2022 "Speed is outside operational parameters. Set the speed between 5 kn and 49 kn."
45	THROTTLE POS OUT OF RANGE CHANGE POSITION	Error code: 2023 "Throttle outside operational range. Reduce throttle."

5.6 How to Adjust the Settings for Your GC-001

All settings for your GC-001 can be adjusted or changed from the [SYSTEM MENU].



Note 1: The procedures outlined in this section use the phrase “Open the [SYSTEM MENU].” For how to access the [SYSTEM MENU], see section 5.4.

Note 2: The procedures outlined in this section use the phrase “Close the menu.” This means “Press  several times until the main screen is shown.”

5.6.1 How to lock/unlock the keys

You can lock the keys to prevent accidental operation.

To lock or unlock the keys, follow the procedure below.

1. Open the [SYSTEM MENU].
2. Select [KEY LOCK].
3. Select [LOCK] to lock the keys. The message "KEY LOCK" appears on the screen and all keys, except , are locked.
4. To unlock the keys, press , then select [UNLOCK].
5. Close the menu.

Note: The keys are automatically unlocked if an alert is released, or if the power is turned off.





5.6.2 How to change the buzzer and vibration settings

Your GC-001 can release an audible alert and/or vibrate to inform you of alerts. Both the audible alert (buzzer) and the vibration can be turned on or off, to suit your requirements.

To change the buzzer and vibration settings, follow the procedure below.

1. Open the [SYSTEM MENU].
2. Select [ALARM]. The buzzer and vibration menu appears.
3. Select [BUZZER] or [VIBRATION] as required.
4. Select [ON] or [OFF] as required.
When [BUZZER] is set to [ON], the buzzer sounds for approximately two seconds.
When [VIBRATION] is set to [ON], the unit vibrates for approximately two seconds.

Further, the vibration and buzzer indications at the bottom of the screen change according to the setting, as shown in the table below.

	[ON]	[OFF]		[ON]	[OFF]
[BUZZER]			[VIBRATION]		

5. Close the menu.

5.6.3 How to enable/disable the gesture-to-turn feature

The gesture-to-turn lets you “steer” your boat by simply pressing the **DIRECT** key

() while moving the GC-001.

To enable/disable the gesture-to-turn, follow the procedure below.

1. Open the [SYSTEM MENU].
2. Select [DIRECT], then select [ON] or [OFF] as required.
3. Close the menu.

Note: For how to use the gesture-to-turn feature, see section 5.7.

5.6.4 How to turn the screen’s backlight on/off

The GC-001’s LCD screen has a backlight which you can turn on/off to suit your needs.

To turn the backlight on/off, follow the procedure below.

1. Open the [SYSTEM MENU].
2. Select [BACKLIGHT], then select [ON] or [OFF] as required.
3. Close the menu.

5.6.5 How to set the sleep timer

If there is no operation of the GC-001 within the time set for [SLEEP MODE], the GC-001 goes into sleep mode. This helps save battery life and can help to increase the life of the LCD. The timer begins immediately after the last operation. Any operation before the set time will reset the timer.

To set the sleep mode timer, follow the procedure below.

1. Open the [SYSTEM MENU].
2. Select [SLEEP MODE]. The sleep mode timer settings appear.
3. Select the appropriate timer. The available selections are [30SEC] (thirty seconds), [1MIN] (one minute) and [3MIN] (three minutes).
4. Close the menu.

5.6.6 How to use the [AUTO OFF] feature

You can set a time, similar to the sleep mode timer, after which your GC-001 will automatically turn off.

To set the [AUTO OFF] time, follow the procedure below.

1. Open the [SYSTEM MENU].
2. Select [AUTO OFF]. The time settings appear.
3. Select the appropriate time. The available selections are [OFF], [1H] (one hour), [3H] (three hours) and [6H] (six hours).
The GC-001 turns off after the time set here lapses, when the GC-001 is in sleep mode. Select [OFF] to disable the [AUTO OFF] feature.
4. Close the menu.

5.7 How to Use the Gesture-To-Turn Feature

The gesture-to-turn feature allows you to remotely turn your vessel, without using the helm. Before you can use this feature, check the following requirements:

- Is the GC-001 and NAVpilot-300 turned on?
Both units must be powered to use this feature.
- Is the gesture-to-turn feature is enabled?
To check this setting, see section 5.6.3.
- Is the GC-001 paired with the system?
If you have only one GC-001, pairing is already completed. For additional GC-001s, see section 5.8 for the pairing procedure.

To use the gesture-to-turn follow the procedure below.

Note: Inform your crew and passengers before using the gesture-to-turn feature.

1. Referring to section 2.2 or section 5.9.2, set the system to AUTO mode.
The gesture-to-turn function is not available in other modes.
2. Facing the bow, press and hold .
3. Move the GC-001, in a horizontal arc, in the direction you want to turn. The rudder is adjusted to turn your vessel in that direction.

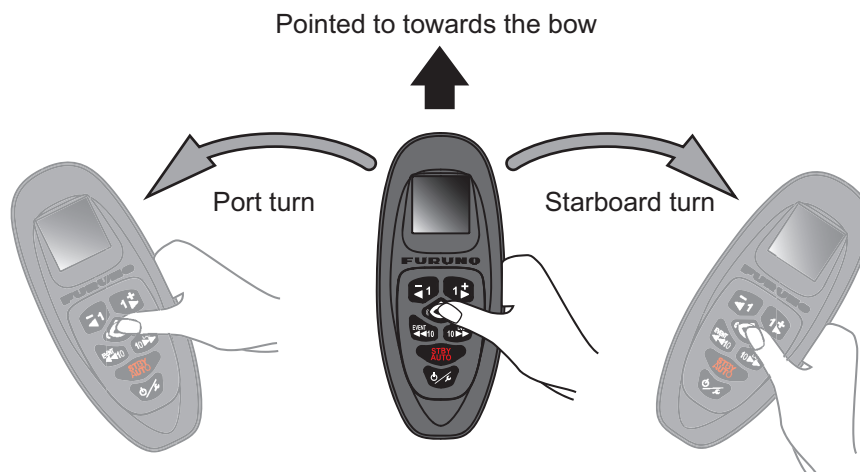

The turn direction and bearing indications on the GC-001 also change accordingly. The example below shows a starboard turn.

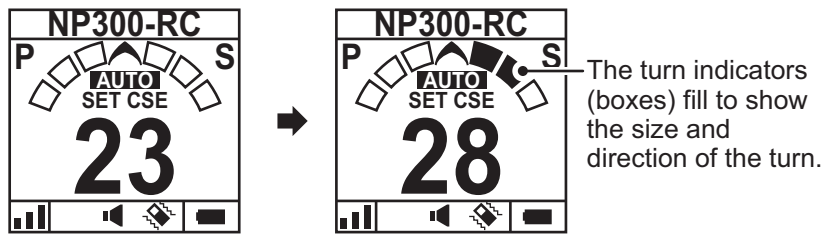

There are three turn indicator boxes to both port and starboard. Depending on the size of the turn, the boxes fill accordingly.

4. Release .

The heading at which the key is released becomes the set heading.

5.8 How to Connect (Pair) the GC-001 with Your NAVpilot-300

The NAVpilot-300 system communicates with the GC-001, via Bluetooth®. To use the GC-001 with your NAVpilot-300, they must be paired. A maximum of three GC-001s can be connected to the processor unit. Your NAVpilot system is supplied with one GC-001 which is paired at installation.

Note: Where more than one GC-001 is paired to your system, to avoid simultaneous operation, the last-received remote signal is used for operation.

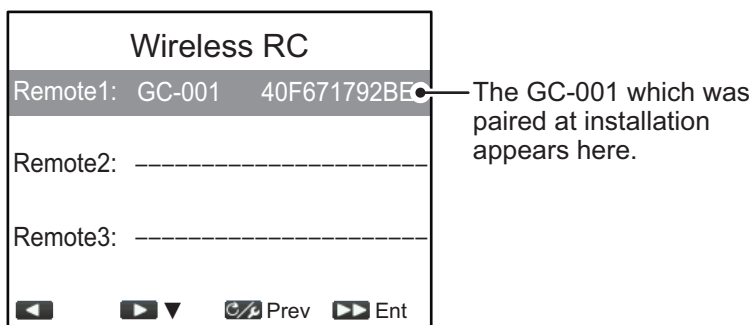

To pair a new GC-001 with the system, follow the procedure below.

1. On the NAVpilot-300, open the menu.
2. Select [Wireless RC]. GC-001s which are paired with your NAVpilot-300 are listed. Your NAVpilot-300 system is already connected to one GC-001 and the connected GC-001 appears at the top of the list. Available connections appear blank (indicated as “bars”).

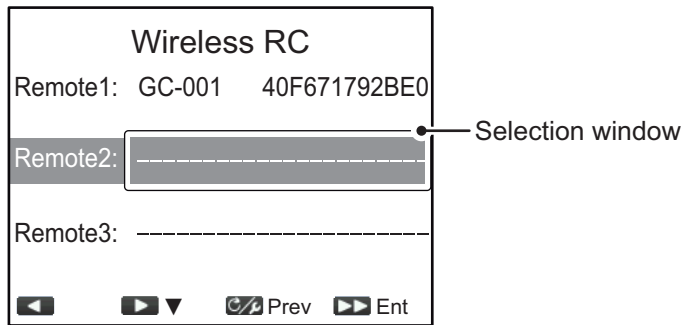

3. Select [Remote1], [Remote2] or [Remote3] as appropriate.
The device selection window appears.



4. On your GC-001, press  to turn the GC-001 on.
5. When the startup process for the GC-001 is complete, press . The GC-001 menu appears.
6. Select [SYSTEM MENU].
7. Select [PAIRING].
8. Select [YES]. The message "PAIRING..." appears on the GC-001 display.
9. On the NAVpilot-300, select the GC-001 to be paired from the device selection window, then press .

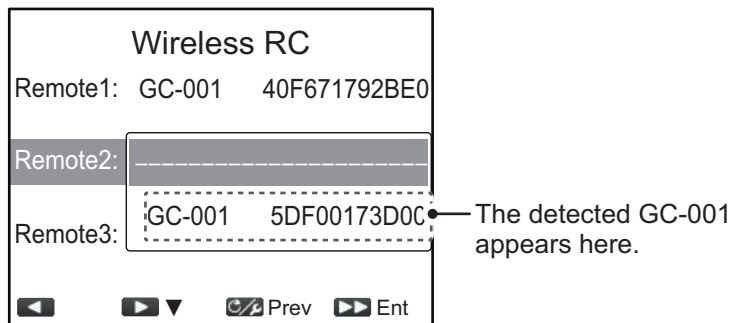

Note: If the GC-001 to be paired is not selected within 20 seconds, the message "TIME OUT!" appears on the GC-001 and the device selection window closes on the NAVpilot-300. In this case, repeat the above procedure from step 8.

The NAVpilot-300 system and the GC-001 are connected and paired when the STBY window (example shown to the right) appears on the GC-001.

10. Close the menu.

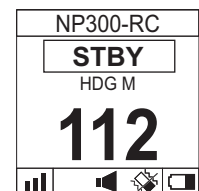







5.9 GC-001 Operations With NAVpilot-300

Depending on the NAVpilot-300's operating mode, the function of most keys on your GC-001 changes. The following sections cover the function of each key, based on the NAVpilot-300's operating mode.

Note: Where more than one GC-001 is paired to your system, to avoid simultaneous operation, the last-received remote signal is used for operation.







5.9.1 Standby (STBY) mode



Name	Description
PORT1 key 	<u>Long press:</u> Activates [NFU(PORT)] mode until the key is released. Release the key to return to STBY mode.
PORT10 key 	
STBD1 key 	<u>Long press:</u> Activates [NFU(PORT)] mode until the key is released. Release the key to return to STBY mode.
STBD10 key 	
DIRECT key 	No function in [STBY] mode.
STBY AUTO key 	<u>Short press, with no destination set at the GPS navigator:</u> Activates [AUTO] mode. <u>Short press, with a destination set at the GPS navigator:</u> Open the mode ([NAV]/[AUTO]/[CANCEL]) selection window.
POWER/MENU key 	<u>Short press:</u> Opens the [TURN] menu. <u>Long press:</u> Turns the GC-001 off.

Note 1: In STBY mode, the  key has no "long press" function.

Note 2: In STBY mode, the  ,  ,  and  keys have no "short press" function.







5.9.2 Autopilot (AUTO) mode

Name	Description
PORT1 key 	<u>Short press:</u> Changes the course on the NAVpilot-300 to port by 1°.
PORT10 key 	<u>Short press:</u> Changes the course on the NAVpilot-300 to port by 10°.
STBD1 key 	<u>Short press:</u> Changes the course on the NAVpilot-300 to port by 1°.
STBD10 key 	<u>Short press:</u> Changes the course on the NAVpilot-300 to port by 10°.
DIRECT key 	Activates the gesture-turn function. See section 5.7 for how to use the gesture-to-turn function.
STBY AUTO key 	<u>Short press:</u> Activates [STBY] mode.
POWER/MENU key 	<u>Short press:</u> Opens the [TURN] menu. <u>Long press:</u> Turns the GC-001 off.

Note 1: In AUTO mode, all keys, except for the  and  keys, do not have a “long press” function.

Note 2: To use the  key, the setting for [DIRECT] in the [SYSTEM] menu must be set to [ON]. If [DIRECT] is set to [OFF], the key has no function in Autopilot mode.







5.9.3 Navigation (NAV) mode

Name	Description
PORT1 key 	<u>Long press:</u> Activates [DODGE(PORT)] mode until the key is released. Release the key to return to the current turn mode.
PORT10 key 	
STBD1 key 	<u>Long press:</u> Activates [DODGE(PORT)] mode until the key is released. Release the key to return to the current turn mode.
STBD10 key 	
DIRECT key 	No function in [NAV] mode.
STBY AUTO key 	<u>Short press:</u> Activates [STBY] mode.
POWER/MENU key 	<u>Short press:</u> Opens the [TURN] menu. <u>Long press:</u> Turns the GC-001 off.

Note 1: In NAV mode, the  key does not have a “long press” function.

Note 2: In NAV mode, the  ,  ,  and  keys have no “short press” function.







5.9.4 TURN and FISHHUNTER™ modes

Name	Description
PORT1 key 	<u>Long press:</u> Activates [DODGE(PORT)] mode until the key is released. Release the key to return to the current turn mode.
PORT10 key 	
STBD1 key 	<u>Long press:</u> Activates [DODGE(PORT)] mode until the key is released. Release the key to return to the current turn mode.
STBD10 key 	
DIRECT key 	No function in either of the above modes.
STBY AUTO key 	<u>Short press:</u> Activates [STBY] mode.
POWER/MENU key 	<u>Short press:</u> Opens the [TURN] menu. <u>Long press:</u> Turns the GC-001 off.

Note 1: In either of the above modes, the  keys does not have a “long press” function.

Note 2: In either of the above modes, the  ,  ,  and  keys have no “short press” function.

5.9.5 SABIKI™ mode

Name	Description
PORT1 key 	<u>Short press:</u> Changes the course on the NAVpilot-300 to port by 1°.
PORT10 key 	<u>Short press:</u> Changes the course on the NAVpilot-300 to port by 10°.
STBD1 key 	<u>Short press:</u> Changes the course on the NAVpilot-300 to port by 1°.
STBD10 key 	<u>Short press:</u> Changes the course on the NAVpilot-300 to port by 10°.
DIRECT key 	No function in SABIKI™ mode.
STBY AUTO key 	<u>Short press:</u> Activates [STBY] mode.
POWER/MENU key 	<u>Short press:</u> Opens the [TURN] menu. <u>Long press:</u> Turns the GC-001 off.

Note: In SABIKI™ mode, there is no long press function for any keys, other than











5.10 Diagnostics Menu

The [DIAGNOSTIC] menu contains diagnostic tools for your GC-001.

To access the [DIAGNOSTIC] menu, follow the procedure below.

1. Referring to section 5.4, access the [SYSTEM MENU].
2. Select [DIAGNOSTIC]. The [DIAGNOSTIC] menu appears.

Menu item	Description
[BT TEST]	Tests the Bluetooth® signal strength. Used at installation.
[POWER CHANGE]	This menu is for factory testing only.
[BATTERY]	Checks the remaining battery power.
[SELF TEST]	Conducts a diagnostic test of the GC-001. This test checks the RAM, ROM, BACKUP status and program versions for the GC-001.
[KEY TEST]	Checks the GC-001 keys status. Press each key to highlight the corresponding box in the display. Press the key again to remove the highlight. If a key is not highlighted when pressed, consult your dealer for service. To exit this test, press  three times, in quick succession.
[GYRO TEST]	Use this test if the gesture-to-turn feature seems sluggish or unresponsive. Press  , then gently swing the GC-001. The values for the X, Y and Z indications should change with each movement. If any of these values do not change, the GC-001 may need replacement. Consult your dealer for service.
[SCREEN TEST]	Conducts an LCD check. Press  to cycle through the test screens. Press  to exit this test.
[BUZZER TEST]	Tests the alert buzzer sound. Press  to turn the buzzer sound on, or press  to turn the buzzer sound off.
[VIBRATION TEST]	Tests the alert vibration. Press  to turn the vibration on, or press  to turn the vibration off.
[RE MODE]	This menu item is not used.
[SPURIOUS]	This menu item is not used.
[ALL CLEAR]	Restores all settings for the GC-001 to factory default settings. To restore default settings, select [YES], then press  .

3. Conduct the required tests.
If the test results show "NG", or the test cannot be conducted, contact your local dealer.
4. Close the menu.

5. GESTURE CONTROLLER GC-001

This page is intentionally left blank.

6. MAINTENANCE, TROUBLE-SHOOTING

This chapter provides procedures for maintenance and troubleshooting.

NOTICE

Do not apply paint, anti-corrosive sealant or contact spray to plastic parts or equipment coating.

Those items contain products that can damage plastic parts and equipment coating.

6.1 Preventive Maintenance

Regular maintenance is necessary for best performance. Create a maintenance schedule which includes the items shown below.

Item	Check point	Remedy
Connectors	Check for tight connection.	Tighten loosened connectors.
Cables	Check cables for damage and corrosion.	Replace cables as necessary.
Processor Unit, Control Unit	Dust/dirt on the units.	Use soft, dry cloth to clean the units. For heavy grime, use a cloth moistened with mild detergent to clean the grime, then wipe the unit dry with a separate soft, dry cloth. Do not use acetone, benzene or other solvents as they will damage the unit.
LCD	Dust on the LCD dims picture.	Clean the LCD carefully to prevent damage, with tissue paper and an LCD cleaner. To remove dirt or salt deposits, use an LCD cleaner and wipe slowly with lens paper so as to dissolve the dirt or salt. Change the paper frequently so the salt or dirt will not damage the LCD. Do not use solvents like thinner, acetone or benzine for cleaning.

6.2 Replacement of Fuse

A fuse (125V 2A) in the processor unit protects the equipment from reverse polarity of the ship's mains and equipment fault. If the fuse blows, you cannot turn on the power. Contact your local dealer for service.

 WARNING
<p> Use the proper fuse.</p> <p>Use of a wrong fuse can cause fire or damage the equipment.</p>

Parts name	Type	Code no.	Remarks
Fuse	FGMB-A 125V 2A PBF	000-157-479-10	Supplied as spare parts

6.3 Troubleshooting

The troubleshooting table below provides common faults and the remedies with which to restore normal operation.

Problem	Possible cause/solution
Processor Unit/Control Unit	
"*9°" is shown on the rudder angle.	<ul style="list-style-type: none"> • Check the cable connections between the processor unit and the rudder reference unit. • Contact your local dealer to check the cable connections when necessary.
You cannot turn the power on.	<ul style="list-style-type: none"> • Check the cable connections between the system and the power supply (switchboard, etc.) • Check cables and connectors for damage. • Check that the ship-board battery is within voltage rating. • The fuse may be blown. Contact your local dealer to arrange replacement.
Nothing appears on the screen.	Press  several times to adjust the brilliance.
There is no response when a key is pressed.	<ul style="list-style-type: none"> • Check that the Control Unit is connected to the Processor Unit correctly. • Check cables and connections for damage. • Turn the power off, then on again. If the problem persists, contact your local dealer for service. <p>If the message "Connecting to Processor Unit..." appears, wait a few minutes for the system to complete the start up process.</p>
Helm is not responding in AUTO mode.	<ul style="list-style-type: none"> • If a rudder reference unit is installed, do [Rudder Limit Setup] and conduct a [Rudder Test]. See the Installation Manual (IME-72840-xx; "xx" denotes version) for details. • For Fantum Feedback™ vessels, conduct a rudder test. See the Installation Manual (IME-72840-xx; "xx" denotes version) for details.
Advanced AUTO mode does not activate.	<ul style="list-style-type: none"> • Check connections between this system and the connected GPS device. • Check that the GPS device is functioning normally. • Check the settings for data input (see section 4.3).

Problem	Possible cause/solution
The compass reading and displayed heading are different.	Compass offset may be required. See the Installation Manual (IME-72840-xx; "xx" denotes version) for details.
Not receiving NMEA2000 data.	Check that the NMEA2000 network is turned on. If the NAVpilot is turned on before the NMEA2000 network, restart the NAVpilot.
Gesture Controller GC-001	
You cannot turn the power on.	Replace the batteries. See the User Guide supplied with the GC-001 for how to replace the batteries.
Nothing appears on the screen or the display is difficult to see.	<ul style="list-style-type: none"> The GC-001 may be in sleep mode. Press any key. Battery voltage rating may be low. Replace the batteries. See the User Guide supplied with the GC-001 for how to replace the batteries.
The [TURN] menu is not displayed.	Referring to section 5.8, check the pairing settings.
GC-001 operations are not sent to the NAVpilot system.	<ul style="list-style-type: none"> Referring to section 5.8, check the pairing settings. Referring to section 5.3, check the signal strength. If the indication shows one bar or less, move closer to the processor unit. Further, check the Bluetooth® guidelines outline in the User Guide, supplied with the GC-001.
Gesture-to-turn feature does not work.	<ul style="list-style-type: none"> Referring to section 5.6.3, check that [DIRECT] is set to [ON]. Referring to section 5.8, check the pairing settings. Referring to section 5.3, check the signal strength. If the indication shows one bar or less, the signal may be interrupted or stopped. Move closer to the processor unit and try again.
The FAP-3011 and GC-001 show different modes after the mode is changed.	<ul style="list-style-type: none"> Wait a few moments to allow for data transfer between the two units. When the data is received correctly, the display changes. Change the mode from the FAP-3011.
The power turns off when an alert is received.	<ul style="list-style-type: none"> Referring to section 5.10, conduct a vibration test. If the power turns off when  is pressed, the vibration motor may be faulty. Contact your local dealer for advice. Temporary solution for a faulty vibration motor: Referring to section 5.6.2, turn vibration off. The GC-001 will remain powered, but no longer releases a vibration to inform you of alerts.
The area near the batteries becomes hot to the touch.	Check that no foreign objects are lodged between the batteries and the battery terminals. For how to access the batteries, see the User Guide supplied with the GC-001.

6.4 Diagnostics

Your NAVpilot contains the diagnostics that check the processor unit, control unit, NMEA 0183 input/output, CAN bus, keyboard, screen, rudder, and helm (Accu-Steer FPS 12V/24V helm sensor only). The tests are for use by service technicians, but you can do the tests to help the technician in troubleshooting.

6.4.1 Diagnostic menu

1. While in STBY or OVRD mode, open the menu.
2. Select [Other Menu].
3. Select [System Setup].
4. Select [Diagnostics]. The [Diagnostics] menu appears.

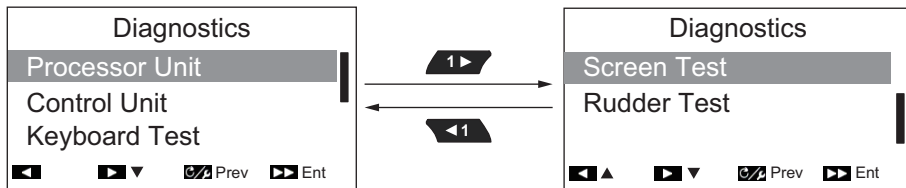

Note: The contents of the [Diagnostics] menu change depending on installation settings for the NAVpilot-300.

See the corresponding section for detail about each menu item in the [Diagnostics] menu.

- Processor Unit: section 6.4.2.
- Control Unit: section 6.4.3.
- Keyboard Test: section 6.4.4.
- Screen Test: section 6.4.5.
- Rudder Test: section 6.4.6.

6.4.2 Processor unit test

This test checks the processor unit for correct operation.

To conduct this test, open the [Diagnostics] menu, then select [Processor Unit].

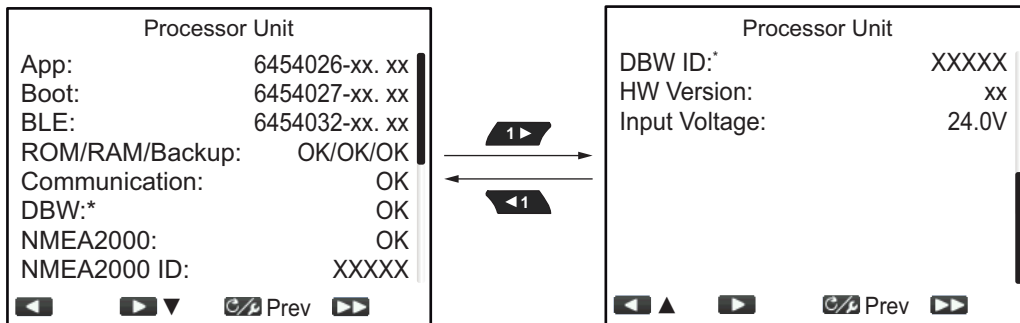

“X” denotes version number
 “X” denotes NMEA2000 ID number
 *: shown only for EVCS vessels

Results appear as “OK” for normal status, “NG” for abnormal status. If “NG” is shown for any item, do the test again. If the result still shows “NG”, consult your dealer.

To go back to the Diagnostics menu, press .

To go back to the normal display screen (close the menus), press and hold .

Processor Unit test item description

- [App]: Shows the application program’s version number.
- [Boot]: Shows the boot program’s version number.
- BLE: Bluetooth® software version number.
- [ROM/RAM/Backup]: Show the status for ROM, RAM and the Backup.
- [Communication]: Shows the results of the communication test between the Control Unit and the Processor Unit.
- [NMEA2000]: Shows the results of the NMMEA2000 test.
- [DBW]: Shows the results for the DBW port test.
- [NMEA2000 ID]: Shows the NMEA2000 network ID.
- DBW ID: Shows the DBW port identification number.
- [HW Version]: Shows the hardware version for the PCB.
- [Input Voltage]: Shows the input voltage.

6.4.3 Control unit test

This test checks the control unit for correct operation.

To conduct this test, open the [Diagnostics] menu, then select [Control Unit].

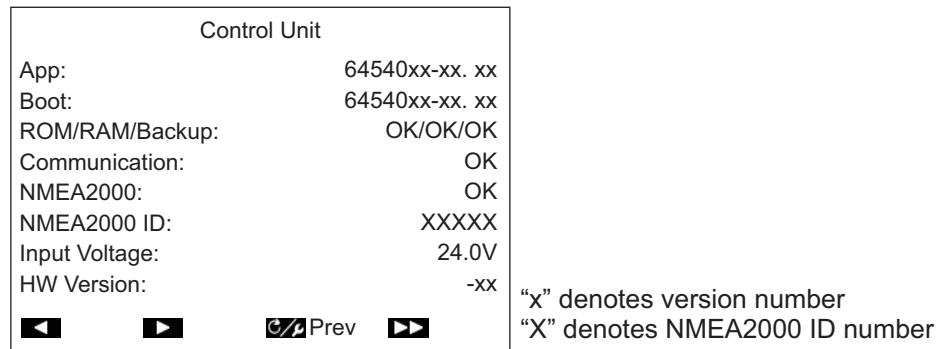

Results appear as "OK" for normal status, "NG" for abnormal status. If "NG" is shown for any item, do the test again. If the result still shows "NG", consult your dealer.

To go back to the Diagnostics menu, press .

To go back to the normal display screen (close the menus), press and hold .

Control Unit test item description

- [App]: Shows the application program's version number.
- [Boot]: Shows the boot program's version number.
- [ROM/RAM/Backup]: Show the status for ROM, RAM and the Backup.
- [Communication]: Shows the results of the communication test between the Control Unit and the Processor Unit.
- [NMEA2000]: Shows the results of the NMMEA2000 test.
- [NMEA2000 ID]: Shows the NMEA2000 network ID.
- [Input Voltage]: Shows the input voltage.
- [HW Version]: Shows the hardware version for the PCB.

6.4.4 Keyboard test

The keyboard test checks the key panel on the control unit.

To conduct this test, open the [Diagnostics] menu, then select [Keyboard Test].

Press each key. The related on-screen location fills in blue if the key operating normally.

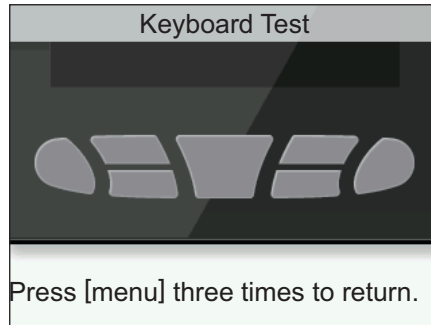

To go back to the Diagnostics menu, press  three times.

To go back to the normal display screen (close the menus), press and hold .

6.4.5 Screen test

The screen test checks the control unit for correct presentation of color tones.

To conduct this test, open the [Diagnostics] menu, then select [Screen Test].

Press  to cycle through the screens in the order shown below.

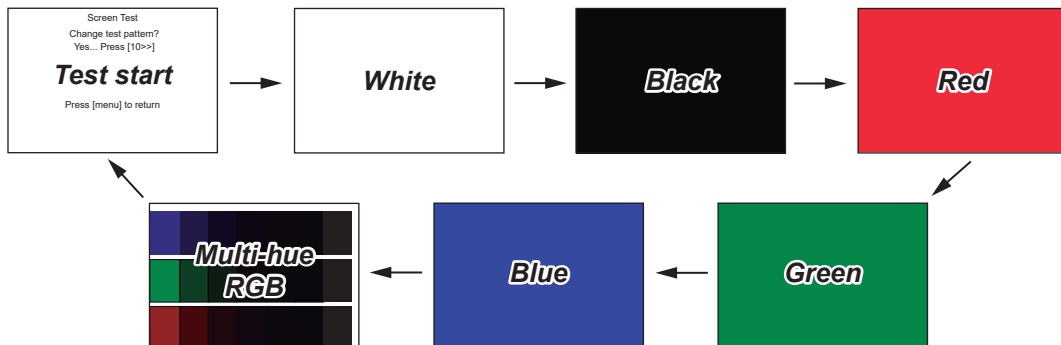

To go back to the Diagnostics menu, press .

To go back to the normal display screen (close the menus), press and hold .

6.4.6 Rudder test

The rudder test checks various aspects of the rudder and controls. To conduct this test, open the [Diagnostics] menu, then select [Rudder Test].

Note: The rudder test is not available when [Boat Type] is set to [EVCS-Pod Drive], [EVCS-Outboard], [EVCS-Inboard] or [EVCS-In/Out].

When the rudder reference unit is installed

1. Open the [Diagnostics] menu, then select [Rudder Test]. The following confirmation message appears.

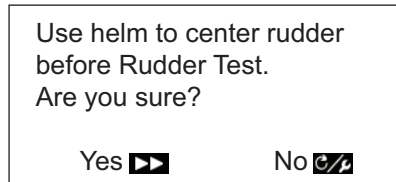

2. Center the rudder then press  to start the rudder test.

The following message appears.

To quit the rudder test at any time, press any key.

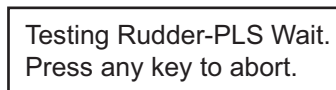

When the test is completed, the following message appears.

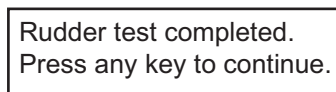

Note 1: If the rudder test is stopped before completion, the steering mode can not be changed from STBY mode.

Note 2: If any of the following messages appears, the rudder test is stopped before completion. Rectify the problem, then re-start the rudder test.

- "Rudder Test failed. Press any Key to continue."
- "Rudder angle error. Check drive circuit. Press any key to continue."
- "Rudder drive error. Check drive circuit. Press any key to continue."

3. Press any key to show the test results.

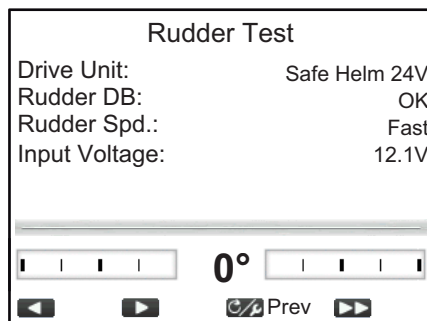

- [Drive Unit]: Drive type used with the NAVpilot: [Reversible 12V (or 24V)] or [Safe-Helm 12V (or 24V)].
- [Rudder Deadband]: Rudder Deadband ([OK] or [Big])
- [Rudder Speed]: Rudder speed ([OK], [Fast], or [Slow])
- [Input Voltage]: Input voltage to the processor unit.

Note 1: If the rudder deadband is higher than 1.3°, the boat may not be controlled correctly. Check for air in the steering system; and check if the rudder speed is greater than 10°/s.

Note 2: Do not turn the power off within two seconds after finishing the rudder test. If the power is turned off accidentally, retry the rudder test.

4. Close the menu.

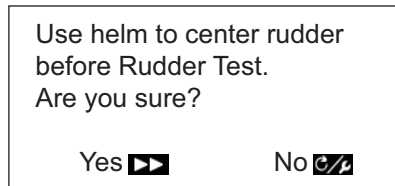

For Fantum Feedback™

1. Open the [Diagnostics] menu, then select [Rudder Test]. The following confirmation message appears.



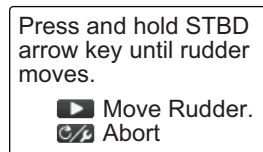

2. Center the rudder then press  to start the rudder test. The following message appears.



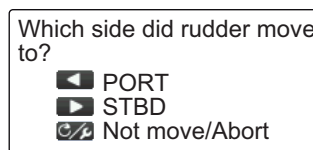

3. Press  and confirm that the rudder moves.
4. Release . The following message appears.



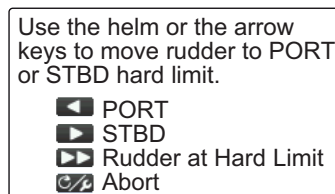

5. Press  or  to confirm the direction in which the rudder moved. The following message appears.



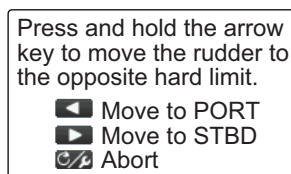

6. Turn the helm, or press  or  to move the rudder to its hard limit. When the rudder can move no further in that direction, press . The following message appears.



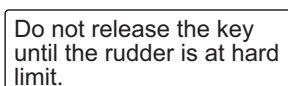

7. Press and hold  or  to move the rudder, in the opposite direction of that chosen at step 6, until it reaches its hard limit. While the rudder is moving, the following message appears.





6. MAINTENANCE, TROUBLESHOOTING

8. When the rudder can move no further in that direction, release  or  to show the following message.



Has the rudder reached the hard limit?
 Yes
 No

9. Do one of the following:

- If the rudder reached the hard limit properly: Press . One of the following messages appears, depending on the key pressed at step 7.



Press and hold the arrow key to move the rudder to the opposite hard limit.
 Move to PORT
 Abort

 is pressed at step 7



Press and hold the arrow key to move the rudder to the opposite hard limit.
 Move to STBD
 Abort

 is pressed at step 7



- If the rudder did not reach the hard limit properly: Press  to show the following message.



Rudder Test is incomplete. Restart?
 Yes
 No

Press  to retry the test from step 6, or press  to abort the test.

10. Press and hold  or  to move the rudder, in the opposite direction of that chosen at step 7, until it reaches its hard limit. While the rudder is moving, the following message appears.

Do not release the key until the rudder is at hard limit.



11. When the rudder can move no further in that direction, release  or  to show the following message.



Has the rudder reached the hard limit?
 Yes
 No

12. Do one of the following:

- If the rudder reached the hard limit properly: Press  to complete the test. the following message appears.

Rudder Test completed. Press any key to continue.

Note: If the steering speed needs to be adjusted, the following message appears. Press  to retry the test from step 6, or press  to abort the test.

Setting may not be correct, rudder peed is inaccurate. Restart rudder test?
 Yes
 No

- If the rudder did not reach the hard limit properly: Press  to show the following message.

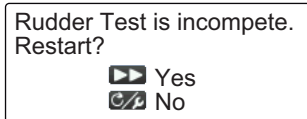

Press  to retry the test from step 6, or press  to abort the test.

13. Press any key to show the rudder test results.

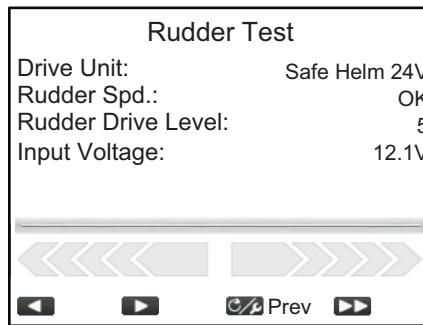

- [Drive Unit:]: Drive type used with the NAVpilot: [Reversible 12V (or 24V)] or [Safe-Helm 12V (or 24V)]
- [Rudder Speed]: Rudder speed ([OK], [Fast], or [Slow])
- [Rudder Drive Level]: The amount of helm operation required to move the rudder.
- [Input Voltage]: Input voltage to the processor unit.

Note: Do not turn the power off for at least two seconds after the rudder test is completed. If the power is turned off, the test is not completed and must be restarted.

14. Close the menu.

6.4.7 Helm sensor test

The helm sensor test checks connection between the processor unit and the Accu-Steer FPS 12V (or 24V) drive. You can start this test from the [Diagnostics] menu in the [System Setup] menu.

Note 1: The following procedure is not available for vessels with drive units other than the Accu-Steer FPS 12V (or 24V) drive.

Note 2: If the helm sensor test was not completed at installation, the [Helm Sensor Test] menu item is not shown in the [Diagnostic] menu.

1. Press  to select [Helm Sensor Test] from the [Diagnostic] menu.

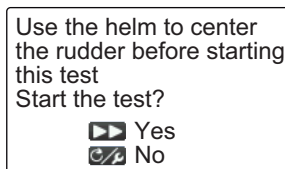

2. Center the rudder then press .

One of the following messages appears.

Turn helm PORT or STBD.
Press any key to abort.

When the RRU is installed

Turn helm to move rudder to
STBD side.
Press any key to abort.

For Fantum Feedback™

3. **When the RRU is installed:** Turn the helm to PORT or STBD direction.

For Fantum Feedback™: Turn the helm to STBD direction.

Turn helm to opposite side.
Press any key to abort.

When the RRU is installed

Turn helm to move rudder to
PORT side.
Press any key to abort.

For Fantum Feedback™

4. **When the RRU is installed:** Turn the helm to the opposite direction from step 3.

For Fantum Feedback™: Turn the helm to PORT direction.

If the connection is normal, the message "Helm Sensor Test completed. Press any key to continue." appears. For failure, "Helm Sensor Test failed. Check the sensor. Press any key to continue." appears. Check that your helm sensor is Accu-Drive FPS 12V/24V. Also, check that the helm sensor is correctly connected to the processor unit.

5. Press any key to show the rudder test result.

Following display example is for the Fantum Feedback™. When the RRU is installed, the appearance of the indicator at the bottom of the screen changes.

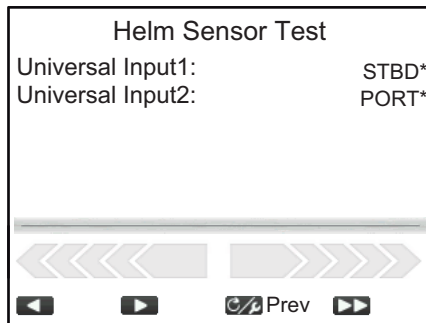



*: "--" appears if the test failed.

6. Press  to close the test result.

6.5 System Data

The system data display allows you to confirm the equipment and drive system status.

To show the system data, follow the procedure below.

1. In STBY, AUTO, NAV or OVRD mode, press  to open the menu.
For Safe Helm, press  then select [MENU] from the [TURN] menu.
2. Select [Other Menu].
3. Select [System Setup].
4. Select [System Data]. The system data appears.

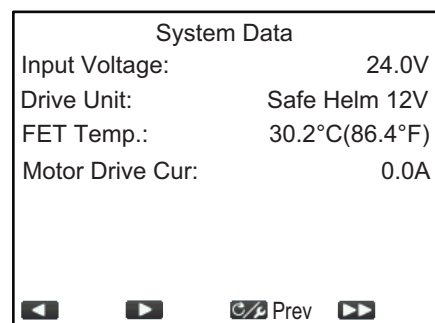

System data contents

- [Input Voltage]: Voltage input to the NAVpilot.
- [Drive Unit]*: Drive type used with the NAVpilot.
- [FET Temp.]: Temperature of the circuit board in the processor unit.
- [Motor Drive Cur]*: Motor drive current.

*: Not shown for the EVC system equipped vessel.

6.6 Messages

Your equipment displays messages to alert you to potential equipment problem and operation status.





6.6.1 Message pop-up display

The system provides various notifications, such as processor unit notifications, test results and violated alerts, as popup messages. These messages are also stored in the [Message] menu.

6.6.2 Message menu

The message menu contains details for the latest alerts.

To show the [Message] menu, follow the procedure below.

1. In STBY, AUTO, NAV or OVRD mode, press  to open the menu.
For Safe Helm, press  then select [MENU] from the [TURN] menu.
2. Select [Message]. The messages appear in descending order of priority. If there is more than one page of messages, press  or  to change pages.

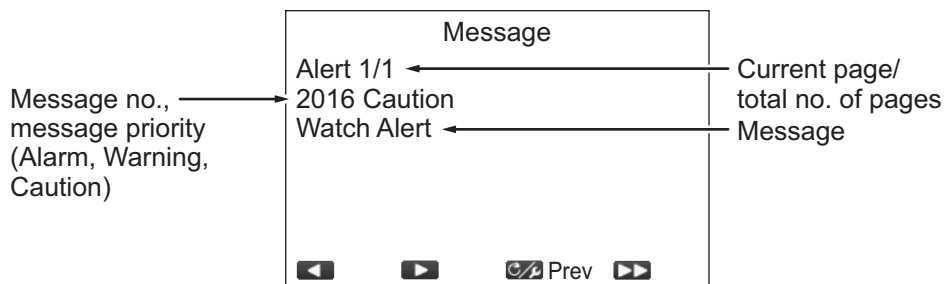

3. Close the menu.

6.6.3 Message description

The following table shows the priority in which alerts are displayed, error code, alert level, message, meaning and remedy (where available) for all messages.

Messages which appear in the Alert Log (see section 3.5) are indicated with a "✓" in the Alert List column. Messages which do not appear in the Alert Log are indicated with a "x".

Prio rity	Error Code	Message	Meaning/remedy	Alert Log
Alert level: Alarm				
1	0001	Communication Error	A communication error has occurred in the processor unit. Turn the power off and request service from your local dealer.	✓
2	0002	Drive unit malfunction. Check the drive circuit.	A malfunction was detected in the drive unit. Turn the power off and request service from your local dealer.	✓
3	0003	Drive unit is overloaded. Check the drive circuit.	The system has detected that the drive unit is overloaded. Turn the power off and request service from your local dealer.	✓
4	0004	Drive unit is overheated. Check the drive circuit.	The drive unit has overheated. Turn the power off and request service from your local dealer.	✓
5	0005	Rudder drive malfunction. Check the drive circuit.	A malfunction was detected in the rudder drive unit. Turn the power off and request service from your local dealer.	✓
6	0006	Rudder angle error. Check the drive circuit.	A malfunction was detected in the drive unit. Turn the power off and request service from your local dealer.	✓
7	0007	BCM error. Check the error information at the BCM.	An abnormality in SUZUKI engine control system has been detected. Turn off the power and contact your local SUZUKI dealer.	✓
8	0008	Lever error. Check the error information at the BCM.	An abnormality in the remote control lever voltage has been detected. Turn off the power and contact your local SUZUKI dealer.	✓
9	0009	GATEWAY Disconnected. Check the connections with the GATEWAY.	Communication failure between the control unit and SUZUKI GATEWAY. Check the connection between the control unit and the GATEWAY.	✓
10	0010	Engine control authorization error. Check the error information at the BCM.	Unable to obtain engine control rights from SUZUKI engine control system. Turn off the power and contact your local SUZUKI dealer.	✓
11	0011	Authorization error. Check the connections with the GATEWAY, then restart the NAVpilot-300	Communication failure between the control unit and SUZUKI GATEWAY. Check the connection between the control unit and the GATEWAY.	✓
Alert level: Warning				
12	1001	Reduce speed for SABIKI (<5kn)	You attempted to activate SABIKI mode, but your vessel's speed is over 5 kn. Reduce speed to below 5 kn and try again.	✓

Priority	Error Code	Message	Meaning/remedy	Alert Log
13	1002	Communication error with EVC system.	There is a problem with the connection between the processor unit and the IPS. Check the connections.	✓
14	1003	Communication error between processor unit and control unit.	There is a problem in the connection between the processor unit and control unit. Check the connections.	✓
15	1004	No heading data available.	No heading data is being received. Check connection to, and status of, the heading sensor.	✓
16	1005	Sudden change in heading data.	A sudden change in heading data was detected. Check the status of the heading sensor.	✓
17	1006	Rate sensor error.	An error message was received from the heading sensor. Check the status of the heading sensor.	✓
18	1013	Initializing heading sensor. This takes two minutes, please wait.	The heading sensor is being initialized. Wait until the initialization process is complete (approx. two minutes).	✓
19	1016	Throttle levers not aligned. Make sure both throttle levers are at the same position.	Left and right levers are too far apart. Align the left and right lever positions.	✓
20	1007	No speed data available. Check speed source or enter manual speed value in Parameter Setup.	There is no speed data input. Check the sensor source for speed data, or enter a value for speed manually. (See section 4.1.3.)	✓
21	1008	No NAV data available.	There is no NAV data input. Check connection with the sensor used as NAV data source.	✓
22	1009	NAV data quality degraded.	Low quality navigational data is input. Check the status of the sensor used as NAV data source.	✓
23	1010	No position data available.	There is no position data input. Check status of positioning sensor.	✓
24	1011	Too fast for this mode. Reduce speed to less than 10 knots.	The mode you selected requires a speed of less than 10 knots. Reduce your speed to below 10 knots.	✓
25	1012	Backup data error.	An error has occurred in the backup data, stored in the processor unit. When this error occurs, all settings are returned to factory default. Installation setup is required, contact your local dealer for advice.	×
Alert level: Caution				
26	2018	Throttle operation error. Set the throttle to neutral.	Lever operation is detected while lever operation is not available. Return the lever to N to enable it.	
27	2019	Point Lock is not available. Point Lock mode is not available due to wind and current.	Point Lock™ is not available due to the bow direction and the direction in which the ship is swept do not match. Start Point Lock™ with the stern facing the wind and stop, or change the sea area.	



6. MAINTENANCE, TROUBLESHOOTING

Priority	Error Code	Message	Meaning/remedy	Alert Log
28	2020	Distance to fixed point is too far. Point Lock mode has stopped, set to STBY mode.	Too far from the Point Lock™ destination. Adjust [Sensitivity] or change the sea area and restart Point Lock™.	
29	2001	Input voltage is too low.	Voltage input is too low. Check the ship's power and status.	✓
30	2002	Input voltage is too high.	Voltage input is too high. Check the ship's power and status.	✓
31	2003	Error in NAV mode parameters. Change modes.	There is an error in the parameters for NAV mode. Change the mode to other than NAV mode.	×
32	2021	Speed control affected by external conditions. Adjust the throttle accordingly. Use caution as vessel speed may change abruptly.	Speed control is not stable due to external conditions. Operate the lever to adjust the ship speed, or refer to the installation manual and reset the [Engine Setup] correctly.	
33	2004	Compass settings incomplete. Set compass calibration from menu.	Compass settings are incomplete, or an error in the settings was detected. Check and complete the compass offsets from the [Compass Setup] menu in the [Sea Trail] menu. See the Installation Manual for details.	×
34	2005	Heading source changed. Compass settings incomplete. Set compass calibration from menu.	The source for heading data has changed. Recalibrate the compass from the [Compass Setup] menu in the [Sea Trail] menu. See the Installation Manual for details.	✓
35	2008	EVC Override.	Override mode was activated.	×
36	2009	Arrived at final waypoint.	You have arrived at the final waypoint of your route.	×
37	2010	Waypoint was updated.	The system has switched to the next waypoint.	×
38	2011	Fish Hunter mode activated.	A Fish Hunter™ turn was activated.	×
40	2013	Watch Alert!	10 minutes have lapsed since the last watch alert. Press any key.	×
41	2006	Position source changed.	The data source for positioning changed.	✓
42	2007	Speed source changed.	The data source for speed (SOG/STW) changed.	✓
43	2014	NAV mode complete. Switching modes.	NAV mode has completed and the system has switched to different mode.	×
44	2017	Helm sensor error.	There is a problem with the helm sensor data. Check the helm sensor status.	✓
45	2015	Deviation alert.	Detected a deviation from the set course (see section 3.3). Adjust heading accordingly.	×
46	2016	Watch alert!	The watch alert was released (see section 3.2). Press any key.	×
47	2022	Speed is outside operational parameters. Set the speed between 5 kn and 49 kn.	The set ship's speed is out of the range of speed control. Operate the lever and set ship speed between 5kn or more and less than 49kn.	

Priority	Error Code	Message	Meaning/remedy	Alert Log
48	2023	Throttle outside operational range. Reduce throttle.	The lever is opening too large. Lower the lever position.	

6.7 How to View the Sensors in Use

The [View Sensors In Use] menu provides a comprehensive list of the sensors connected to your NAVPILOT. To show the [View Sensors In Use] menu, follow the procedure below.

- In STBY, AUTO, NAV or OVRD mode, press  to open the menu.
For Safe Helm, press  then select [MENU] from the [TURN] menu.
- Select [View Sensors In Use]. The list of sensors used as a data source appears.

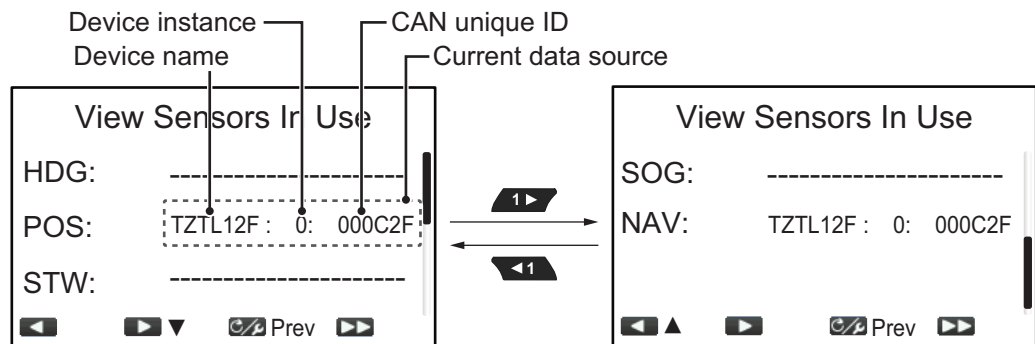

The display shows the device used as the source for each data type with the device instance and unique CAN ID for the source device.

Dashed lines indicate no connection or sensor is not currently active.

- Close the menu.

6. MAINTENANCE, TROUBLESHOOTING

This page is intentionally left blank.

APPX. 1 MENU TREE

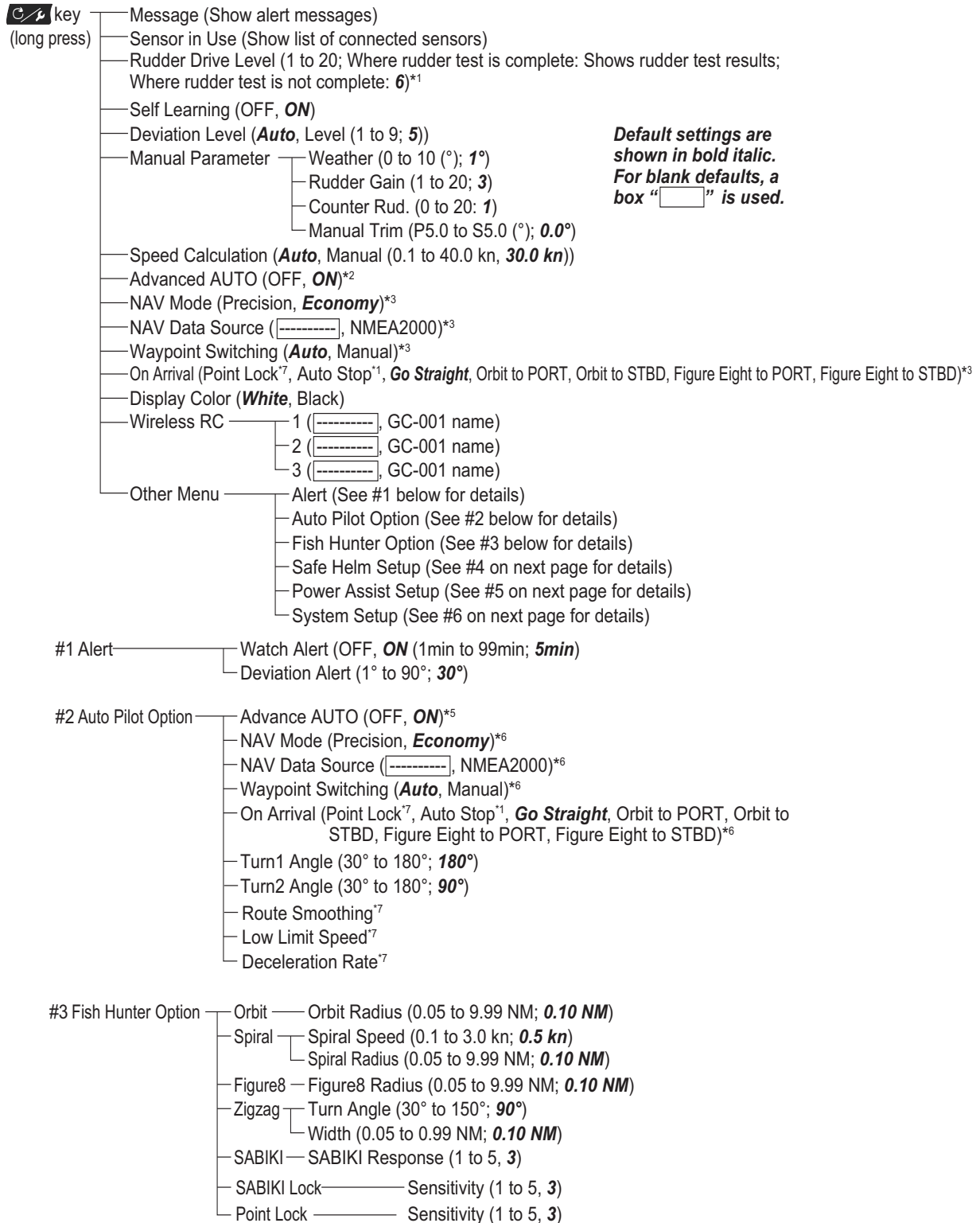

*1: Available only with Fantum Feedback™	*3: Shown only when NAV mode is active.	*5: Not shown when AUTO mode is active.	*7: Shown only when FishHunter™ Drive is active.
*2: Shown only when AUTO mode is active.	*4: Not shown when STBY or OVRD mode is active.	*6: Not shown when NAV mode is active.	

APPX. 1 MENU TREE

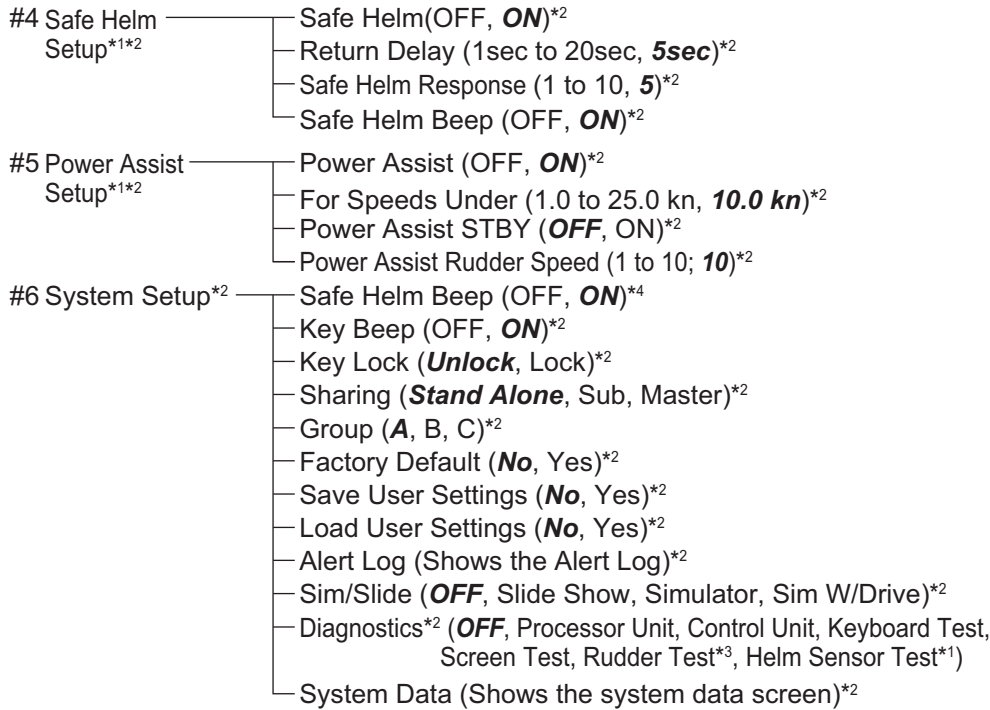

*1: Available only when the following settings and tests are completed at installation:

- [Drive Unit] is set to either [Safe Helm12V] or [Safe Helm24V].
- [Helm Sensor Test] is completed.

*2: Shown only when STBY or OVRD mode is active.

*3: Not shown when the installation setting for [Boat Type] is [EVCS-Pod Drive], [EVCS Inboard], [EVCS- IN/OUT] or [EVCS-Outboard].

*4: Shown only when connected to DOMETIC OPTIMUS and [Boat Type] is [EVCS-Pod Drive], [EVCS Inboard], [EVCS- IN/OUT], [EVCS Inboard] or [EVCS-Outboard].

GC-001 Menu Tree

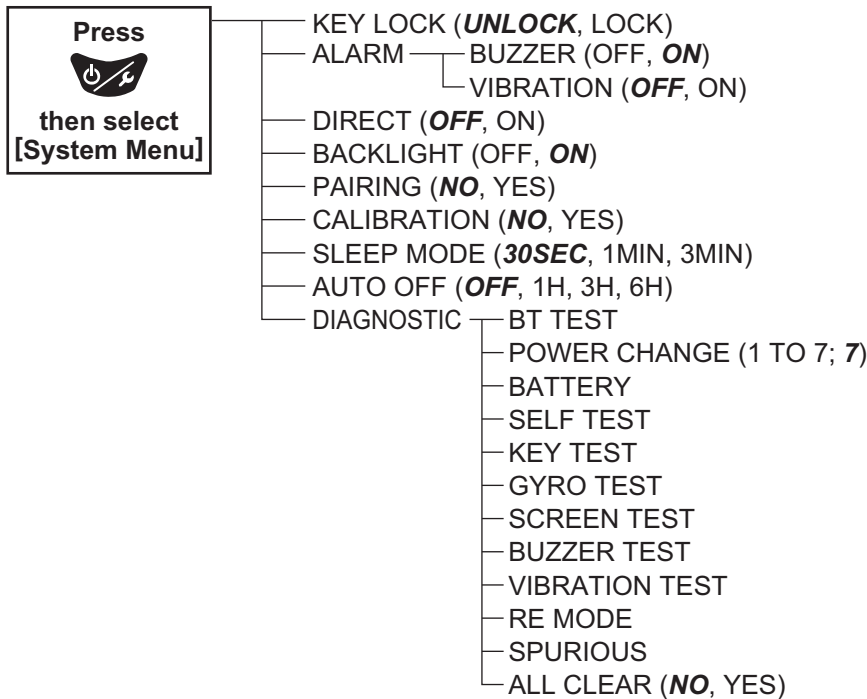

**SPECIFICATIONS OF AUTOPILOT
NAVpilot-300**

1 CONTROL UNIT

- 1.1 Screen type 4.1-inch TFT color LCD, 320 x 240 (QVGA)
- 1.2 Brilliance 700 cd/m² typical
- 1.3 Contrast 8 steps
- 1.4 Max. number of unit in a network 3 units

2 PROCESSOR UNIT

- 2.1 Steering mode STBY, Auto, Dodge, NFU (Non-follow up), Turn, Advanced auto*, Navigation*, FishHunterTM*, Override
*: navigation data required
- 2.2 Rudder gain Auto/ 1-20 (Manual)
- 2.3 Counter rudder Auto/ 0-20 (Manual)
- 2.4 Trim adjustment -5° (port) to +5° (stbd)
- 2.5 Course change speed 1 to 20 deg/s
- 2.6 Alarm Heading deviation, Watch
- 2.7 Motor drive 10 A continuous, 20 A for 5 seconds

3 GESTURE CONTROLLER

- 3.1 Screen type 1.28-inch TFT LCD, 128 x 128
- 3.2 Communication distance 10 m wide view (depended on environmental conditions)
- 3.3 Source 3 VDC, Dry cell battery (AAA, 2 pcs)

4 INTERFACE

- 4.1 Number of port
 - NMEA2000 1 port
 - CAN bus 1 port, DBW control
 - Contact signal 3 ports, Safe helm, STBY switch
 - USB 1 port, for maintenance only
- 4.2 Bluetooth LE Between processor unit and gesture controller
 - Frequency 2.4 GHz
 - Transmit power +4 dBm
- 4.3 NMEA2000 PGN
 - Input 059392/904, 060160/416/928, 061184, 065240, 126208/464/720/992/996, 127237/250/258, 128259, 129025/026/029/283/284/285/538, 130577/818/821/827/841
 - Output 059392/904, 060928, 126208/464/720/993/996/998, 127237/245, 130816/821/822/823/827/841

5 POWER SUPPLY

- 5.1 Processor unit 12-24 VDC (10.8-31.2 V): 0.22 A max., LEN: 2
- 5.2 Control unit 15 VDC: 0.29 A max., LEN: 6

6 ENVIRONMENTAL CONDITIONS

- | | | |
|-----|----------------------|---|
| 6.1 | Ambient temperature | -15°C to +55°C |
| 6.2 | Relative humidity | 95% or less at +40°C |
| 6.3 | Degree of protection | |
| | Processor unit | IP55 |
| | Control unit | IP56 |
| | Gesture controller | IP65/67 (second numeral characteristic as follows) |
| | | 5: Protected against water jets. |
| | | 7: Protected against the effects of temporary immersion in water. |
| 6.4 | Vibration | IEC 60945 Ed.4 |

7 UNIT COLOR

- | | | |
|-----|-------------------------|------|
| 7.1 | Processor/ control unit | N2.5 |
| 7.2 | Gesture controller | N1.0 |

INDEX

A

ADVANCED AUTO mode	2-4
Alert Log	3-3
Alert menu	3-2
Alerts	3-1
alert log	3-3
alert menu	3-2
deviation alert	3-2
watch alert	3-2
AUTO mode	2-2

C

Compass, rudder display	1-7
Control description	
NAVpilot-700	1-1
NAVpilot-720	5-1
Control unit test	6-6

D

Deviation alert	3-2
Diagnostics	
control unit test	6-6
diagnostics menu	6-4
keyboard test	6-7
processor unit test	6-5
rudder test	6-8
screen test	6-7
Dodge	
NAV/TURN/FishHunterTM mode	2-20
STBY mode	2-20

F

Figure-eight turn	2-14
FishHunter mode	
figure-eight turn	2-14
orbit turn	2-12
spiral turn	2-13
zigzag turn	2-15
Fuse replacement	6-2

K

Keyboard test	6-7
---------------------	-----

M

Maintenance	6-1
Menu tree	AP-1
Messages	6-13

N

NAV mode	
boat's behavior after switching waypoint	2-8
data source	4-5
description	2-5
sailing method for	2-7
waypoint switching method	2-7
NFU dodge in STBY mode	2-20

O

Orbit turn	2-12
------------------	------

P

Parameter setup menu	4-2
Power assist mode	2-24
POWER/BRILL key (NAVpilot-300)	1-3
Processor Unit test	6-5

R

Rudder Drive Level	4-4
Rudder test	6-8

S

SABIKI mode	2-17
operation	2-18
Safe helm mode	2-22
Screen test	6-7
Speed calculation	4-4
Spiral turn	2-13
STBY mode	
description	2-1
System configuration	x
System data	6-12

T

TURN mode	
turn selection	2-8

Z

Zigzag turn	2-15
-------------------	------

FURUNO Worldwide Warranty for Pleasure Boats (Except North America)

This warranty is valid for products manufactured by Furuno Electric Co. (hereafter FURUNO) and installed on a pleasure boat. Any web based purchases that are imported into other countries by anyone other than a FURUNO certified dealer may not comply with local standards. FURUNO strongly recommends against importing these products from international websites as the imported product may not work correctly and may interfere with other electronic devices. The imported product may also be in breach of the local laws and mandated technical requirements. Products imported into other countries as described previously shall not be eligible for local warranty service.

For products purchased outside of your country please contact the national distributor of Furuno products in the country where purchased.

This warranty is in addition to the customer's statutory legal rights.

1. Terms and Conditions of Warranty

FURUNO guarantees that each new FURUNO product is the result of quality materials and workmanship. The warranty is valid for a period of 2 years (24 months) from the date of the invoice, or the date of commissioning of the product by the installing certified dealer.

2. FURUNO Standard Warranty

The FURUNO standard warranty covers spare parts and labour costs associated with a warranty claim, provided that the product is returned to a FURUNO national distributor by prepaid carrier.

The FURUNO standard warranty includes:

- Repair at a FURUNO national distributor
- All spare parts for the repair
- Cost for economical shipment to customer

3. FURUNO Onboard Warranty

If the product was installed/commissioned and registered by a certified FURUNO dealer, the customer has the right to the onboard warranty.

The FURUNO onboard warranty includes

- Free shipping of the necessary parts
- Labour: Normal working hours only
- Travel time: Up to a maximum of two (2) hours
- Travel distance: Up to a maximum of one hundred and sixty (160) KM by car for the complete journey

4. Warranty Registration

For the Standard Warranty - presentation of product with serial number (8 digits serial number, 1234-5678) is sufficient. Otherwise, the invoice with serial number, name and stamp of the dealer and date of purchase is shown.

For the Onboard Warranty your FURUNO certified dealer will take care of all registrations.

5. Warranty Claims

For the Standard Warranty - simply send the defective product together with the invoice to a FURUNO national distributor. For the Onboard Warranty – contact a FURUNO national distributor or a certified dealer. Give the product's serial number and describe the problem as accurately as possible.

Warranty repairs carried out by companies/persons other than a FURUNO national distributor or a certified dealer is not covered by this warranty.

6. Warranty Limitations

When a claim is made, FURUNO has a right to choose whether to repair the product or replace it.

The FURUNO warranty is only valid if the product was correctly installed and used. Therefore, it is necessary for the customer to comply with the instructions in the handbook. Problems which result from not complying with the instruction manual are not covered by the warranty.

FURUNO is not liable for any damage caused to the vessel by using a FURUNO product.

The following are excluded from this warranty:

- a. Second-hand product
- b. Underwater unit such as transducer and hull unit
- c. Routine maintenance, alignment and calibration services.
- d. Replacement of consumable parts such as fuses, lamps, recording papers, drive belts, cables, protective covers and batteries.
- e. Magnetron and MIC with more than 1000 transmitting hours or older than 12 months, whichever comes first.
- f. Costs associated with the replacement of a transducer (e.g. Crane, docking or diver etc.).
- g. Sea trial, test and evaluation or other demonstrations.
- h. Products repaired or altered by anyone other than the FURUNO national distributor or an authorized dealer.
- i. Products on which the serial number is altered, defaced or removed.
- j. Problems resulting from an accident, negligence, misuse, improper installation, vandalism or water penetration.
- k. Damage resulting from a force majeure or other natural catastrophe or calamity.
- l. Damage from shipping or transit.
- m. Software updates, except when deemed necessary and warrantable by FURUNO.
- n. Overtime, extra labour outside of normal hours such as weekend/holiday, and travel costs above the 160 KM allowance
- o. Operator familiarization and orientation.

FURUNO Electric Company, March 1, 2011

FURUNO Warranty for North America

FURUNO U.S.A., Limited Warranty provides a twenty-four (24) months LABOR and twenty-four (24) months PARTS warranty on products from the date of installation or purchase by the original owner. Products or components that are represented as being waterproof are guaranteed to be waterproof only for, and within the limits, of the warranty period stated above. The warranty start date may not exceed eighteen (18) months from the original date of purchase by dealer from Furuno USA and applies to new equipment installed and operated in accordance with Furuno USA's published instructions.

Magnetrons and Microwave devices will be warranted for a period of 12 months from date of original equipment installation.

Furuno U.S.A., Inc. warrants each new product to be of sound material and workmanship and through its authorized dealer will exchange any parts proven to be defective in material or workmanship under normal use at no charge for a period of 24 months from the date of installation or purchase.

Furuno U.S.A., Inc., through an authorized Furuno dealer will provide labor at no cost to replace defective parts, exclusive of routine maintenance or normal adjustments, for a period of 24 months from installation date provided the work is done by Furuno U.S.A., Inc. or an AUTHORIZED Furuno dealer during normal shop hours and within a radius of 50 miles of the shop location.

A suitable proof of purchase showing date of purchase, or installation certification must be available to Furuno U.S.A., Inc., or its authorized dealer at the time of request for warranty service.

This warranty is valid for installation of products manufactured by Furuno Electric Co. (hereafter FURUNO). Any purchases from brick and mortar or web-based resellers that are imported into other countries by anyone other than a FURUNO certified dealer, agent or subsidiary may not comply with local standards. FURUNO strongly recommends against importing these products from international websites or other resellers, as the imported product may not work correctly and may interfere with other electronic devices. The imported product may also be in breach of the local laws and mandated technical requirements. Products imported into other countries, as described previously, shall not be eligible for local warranty service.

For products purchased outside of your country please contact the national distributor of Furuno products in the country where purchased.

WARRANTY REGISTRATION AND INFORMATION

To register your product for warranty, as well as see the complete warranty guidelines and limitations, please visit www.furunousa.com and click on "Support". In order to expedite repairs, warranty service on Furuno equipment is provided through its authorized dealer network. If this is not possible or practical, please contact Furuno U.S.A., Inc. to arrange warranty service.

FURUNO U.S.A., INC.
Attention: Service Coordinator
4400 N.W. Pacific Rim Boulevard
Camas, WA 98607-9408
Telephone: (360) 834-9300
FAX: (360) 834-9400

Furuno U.S.A., Inc. is proud to supply you with the highest quality in Marine Electronics. We know you had several choices when making your selection of equipment, and from everyone at Furuno we thank you. Furuno takes great pride in customer service.

Declaration of Conformity

[NAVpilot-300]

- Bulgarian (BG)** С настоящото Furuno Electric Co., Ltd. декларира, че гореспоменат тип радиосъоръжение е в съответствие с Директива 2014/53/ЕС, СИ 2017/1206. Цялостният текст на ЕС/УК декларацията за съответствие може да се намери на следния интернет адрес:
- Spanish (ES)** Por la presente, Furuno Electric Co., Ltd. declara que el tipo de equipo radioeléctrico arriba mencionado es conforme con la Directiva 2014/53/UE, SI 2017/1206. El texto completo de la declaración de conformidad de la EU/UK está disponible en la siguiente dirección Internet:
- Czech (CS)** Tímto Furuno Electric Co., Ltd. prohlašuje, že výše zmíněné typ rádiového zařízení je v souladu se směrnici 2014/53/EU, SI 2017/1206. Úplné znění EU/SK prohlášení o shodě je k dispozici na této internetové adrese:
- Danish (DA)** Hermed erklærer Furuno Electric Co., Ltd., at ovennævnte radioudstyr er i overensstemmelse med direktiv 2014/53/EU, SI 2017/1206. EU/UK-overensstemmelseserklæringens fulde tekst kan findes på følgende internetadresse:
- German (DE)** Hiermit erklärt die Furuno Electric Co., Ltd., dass der oben genannte Funkanlagentyp der Richtlinie 2014/53/EU, SI 2017/1206 entspricht. Der vollständige Text der EU/UK-Konformitätserklärung ist unter der folgenden Internetadresse verfügbar:
- Estonian (ET)** Käesolevaga deklareerib Furuno Electric Co., Ltd., et ülalmainitud raadioseadme tüüp vastab direktiivi 2014/53/EL, SI 2017/1206 nõuetele. EL/GB vastavusdeklaratsiooni täielik tekst on kättesaadav järgmisel internetiaadressil:
- Greek (EL)** Με την παρούσα η Furuno Electric Co., Ltd., δηλώνει ότι ο προαναφερθέντας ραδιοεξοπλισμός πληροί την οδηγία 2014/53/ΕΕ, SI 2017/1206. Το πλήρες κείμενο της δήλωσης συμμόρφωσης ΕΕ/UK διατίθεται στην ακόλουθη ιστοσελίδα στο διαδίκτυο:
- English (EN)** Hereby, Furuno Electric Co., Ltd. declares that the above-mentioned radio equipment type is in compliance with Directive 2014/53/EU, SI 2017/1206. The full text of the EU/UK declaration of conformity is available at the following internet address:
- French (FR)** Le soussigné, Furuno Electric Co., Ltd., déclare que l'équipement radioélectrique du type mentionné ci-dessus est conforme à la directive 2014/53/UE, SI 2017/1206. Le texte complet de la déclaration UE/RU de conformité est disponible à l'adresse internet suivante:
- Croatian (HR)** Furuno Electric Co., Ltd. ovime izjavljuje da je gore rečeno radijska oprema tipa u skladu s Direktivom 2014/53/EU, SI 2017/1206. Cjeloviti tekst EU/UK izjave o sukladnosti dostupan je na sljedećoj internetskoj adresi:
- Italian (IT)** Il fabbricante, Furuno Electric Co., Ltd., dichiara che il tipo di apparecchiatura radio menzionato sopra è conforme alla direttiva 2014/53/UE, SI 2017/1206. Il testo completo della dichiarazione di conformità UE/RU è disponibile al seguente indirizzo Internet:
- Latvian (LV)** Ar šo Furuno Electric Co., Ltd. deklarē, ka augstāk minēts radioiekārta atbilst Direktīvai 2014/53/ES, SI 2017/1206. Pilns ES/AK atbilstības deklarācijas teksts ir pieejams šādā interneta vietnē:

- Lithuanian (LT) Aš, Furuno Electric Co., Ltd., patvirtinu, kad pirmiau minėta radijo įrenginių tipas atitinka Direktyvą 2014/53/ES, SI 2017/1206.
Visas ES/JK atitikties deklaracijos tekstas prieinamas šiuo interneto adresu:
- Hungarian (HU) Furuno Electric Co., Ltd. igazolja, hogy fent említett típusú rádióberendezés megfelel a 2014/53/EU, SI 2017/1206 irányelvnek.
Az EU/EK-megfelelőségi nyilatkozat teljes szövege elérhető a következő internetes címen:
- Maltese (MT) B'dan, Furuno Electric Co., Ltd., niddikjara li msemmija hawn fuq-tip ta' taghmir tar-radju huwa konformi mad-Direttiva 2014/53/UE, SI 2017/1206.
It-test kollu tad-dikjarazzjoni ta' konformità tal-UE/RU huwa disponibbli f'dan l-indirizz tal-Internet li ġej:
- Dutch (NL) Hierbij verklaar ik, Furuno Electric Co., Ltd., dat het hierboven genoemde type radioapparaat conform is met Richtlijn 2014/53/EU, SI 2017/1206.
De volledige tekst van de EU/VK-conformiteitsverklaring kan worden geraadpleegd op het volgende internetadres:
- Polish (PL) Furuno Electric Co., Ltd. niniejszym oświadcza, że wyżej wymieniony typ urządzenia radiowego jest zgodny z dyrektywą 2014/53/UE, SI 2017/1206.
Pełny tekst deklaracji zgodności UE/UK jest dostępny pod następującym adresem internetowym:
- Portuguese (PT) O(a) abaixo assinado(a) Furuno Electric Co., Ltd. declara que o mencionado acima tipo de equipamento de rádio está em conformidade com a Diretiva 2014/53/UE, SI 2017/1206.
O texto integral da declaração de conformidade da EU/UK está disponível no seguinte endereço de Internet:
- Romanian (RO) Prin prezenta, Furuno Electric Co., Ltd. declară că echipamentul radio menționat mai sus este în conformitate cu Directiva 2014/53/UE, SI 2017/1206.
Textul integral al declarației de conformitate UE/RU este disponibil la următoarea adresă internet:
- Slovak (SK) Furuno Electric Co., Ltd. týmto vyhlasuje, že vyššie spomínané rádiové zariadenie typu je v súlade so smernicou 2014/53/EÚ, SI 2017/1206.
Úplné EÚ/SK vyhlásenie o zhode je k dispozícii na tejto internetovej adrese:
- Slovenian (SL) Furuno Electric Co., Ltd. potrjuje, da je zgoraj omenjeno tip radijske opreme skladen z Direktivo 2014/53/EU, SI 2017/1206.
Celotno besedilo izjave EU/ZK o skladnosti je na voljo na naslednjem spletnem naslovu:
- Finnish (FI) Furuno Electric Co., Ltd. vakuuttaa, että yllä mainittu radiolaitetyyppi on direktiivin 2014/53/EU, SI 2017/1206 mukainen.
EU/UK-vaatimustenmukaisuusvakuutuksen täysimittainen teksti on saatavilla seuraavassa internetosoitteessa:
- Swedish (SV) Härmed försäkrar Furuno Electric Co., Ltd. att ovan nämnda typ av radioutrustning överensstämmer med direktiv 2014/53/EU, SI 2017/1206.
Den fullständiga texten till EU/Storbritannien-försäkran om överensstämmelse finns på följande webbadress:

Online Resource

http://www.furuno.com/en/support/red_doc

Notice for radiated immunity

The test for the radiated immunity is performed up to 2.7 GHz only without the special condition of spot frequency being applied. There is a chance that this equipment may interfere with allocated services in the frequency range of 2.7 GHz to 6 GHz, particularly in harbors, rivers, lake banks, etc.