



**CV7SF2\_M**  
**Wireless ultrasonic wind vane-anemometer**

**User Manual**  
30/10/2017 rev1.3  
**LCJ Capteurs**  
ZA Le Chêne Ferré  
44120 VERTOU (France)  
Tel: +33 (0)2 40 05 08 55  
<http://www.lcjscapteurs.com>  
[contacts@lcjscapteurs.com](mailto:contacts@lcjscapteurs.com)

Copyright © LCJ Capteurs. All right reserved

No part of this manual can be copied in any form and by any means without prior written consent of LCJ Capteurs.





The products manufactured by LCJ Capteurs are constantly developed. Therefore, the content of this manual can be amended without notice.

This manual does not create any legal bond between LCJ Capteurs and the customer of final user and LCJ Capteurs does not take responsibility for any damage and/or injury resulting from the use of the product described in this manual.

## ZERO-POWER ULTRASONIC WIND VANE / ANEMOMETER

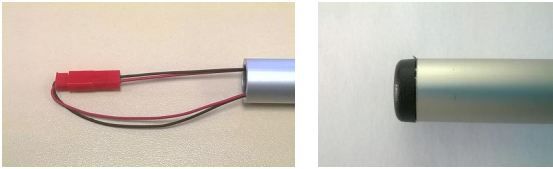
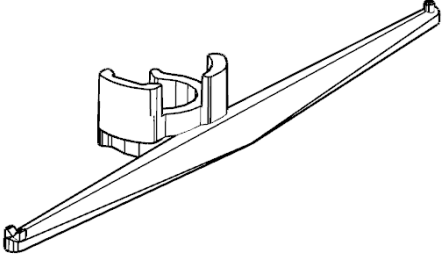
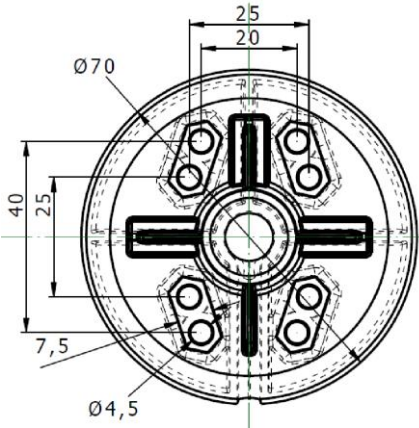
Thank you for purchasing our CV7SF2 model. This ultrasonic wind sensor is simple to use and does not require any external power supply thanks to its solar panel which allows full operation independently. The measurement rate of one per second gives you a clear vision of gusts.

### Quick Installation:

<p>1-Connect the battery and push the cap in.</p> 	<p>3-Align your sensor with the tool supplied.</p> 
<p>2-Mount the sensor on a pole or a vertical surface</p>  <p>Piercing dimensions of the support</p> <p>Note: For mounting on a vertical surface, the angle bracket RA106BRACKET or RA106BRACKINOX from Glomex® is compatible with the borings. (See example below, not provided)</p> 	<p>4-Supply the receiver and connect your application:</p> <p>1: GND 2: NMEA - 3: NMEA + 4: +12 V</p>  <p>5-Your sensor is ready to use</p> 
<p><b>Battery capacity:</b> The CV7SF2 operates independently thanks to its PV panel. The battery supplies sufficient voltage for 35 days without sun.</p>	

# Content

- 1. General information ..... 1
  - A. About this manual ..... 1
  - B. Warnings ..... 1
  - C. Your experience ..... 1
  - D. Safety ..... 1
  - E. Recycling ..... 1
  - F. Warranty ..... 2
  - G. Product return ..... 2
- 2. Introduction ..... 2
- 3. Installation ..... 3
  - A. Delivery control ..... 3
  - B. Opening the box ..... 3
  - C. Choose the best location ..... 3
  - D. Wiring ..... 4
  - E. Power supply ..... 4
  - F. Connection to your application ..... 4
- 4. Starting up ..... 4
- 5. Maintenance ..... 5
- 6. Replacing the battery ..... 5
- 7. Technical specifications ..... 6
  - A. NMEA frames ..... 6
  - B. Data features ..... 6
  - C. Electrical specifications ..... 6
  - D. Autonomy – consumption of sensor ..... 7
  - E. Dimensions (mm) ..... 7
- 8. Declaration of Conformity ..... 8



## 1. General information

### A. About this manual

This manual brings all the required information to install and use the CV7SF2.

Read all the information contained in this manual carefully before using the sensor, as misuse can cause mistakes and damage to the product.

### B. Warnings

Important points are highlighted in this document as follow:



**Warning!** Serious hazard. Read carefully and follow the instructions. High risk of injury or even death.



**Warning!** Potential hazardous situation. Read carefully and follow the instructions to avoid damages on the product or loss of important data.



**Note:** Important information regarding use of the product.

### C. Your experience

LCJ CAPTEURS values your feedback and suggestions to improve the manual. Should you find any mistake, please contact us indicating the chapter, section and page to correct. You can find our details on the manual's cover page and on our website: [www.lcjcapteurs.com](http://www.lcjcapteurs.com).

### D. Safety

When using the product, safety measures described below must be followed to avoid damage and legal responsibility. Follow all safety and use instructions regarding the product. Follow all warning notices indicated in the product's use instructions. The following instructions are meant to reduce all risk of personal injuries, electric shock, fire and damage of the equipment.

Read carefully and follow all instructions contained in this manual to avoid measures errors caused by misuse.



**Warning!** Follow all safety measures applicable for the product's installation.

#### Electric safety measures

This product has been designed to be powered by a battery or a specific power supply. Any other power supply can be hazardous and will result in the product's unconformity.

- Handle the battery with care.



This product contains a Lithium-ion iron phosphate battery (LiFePO<sub>4</sub>). There is a risk of fire if the battery is not correctly handled. Do not attempt to open or repair the battery. Do not dismount the battery, do not press on it, do not drill in it, do not place it in a short-circuit situation, do not throw it in fire or water and do not expose it to temperatures over 60°C (140°F). Use only original LiFePO<sub>4</sub> batteries with original connectors.

- Air transport.



When the product is transported by plane, it must be disconnected. Refer to IATA recommendations.

### E. Recycling

LCJ Capteurs encourages recycling of all material when possible, following local regulations. You can find more details about recycling by contacting the local authorities in charge of Environment Protection in your country.



### European Union (and European Economic Area) only.

These pictograms indicate that the product cannot be disposed of with waste, according to the European Directive DEEE (2002/96/CE), the Directive applying to batteries disposal (2006/66/CE) and local waste regulations following these directives. When a chemical toxicity pictogram is printed below this one, according to the Directive applying to batteries disposal, it means that Heavy Metals are present (Hg = mercury, Cd = cadmium, Pb = lead) in the battery at or above the applicable cut-off concentration specified in the Directive. This product must be given to a disposal centre, i.e. when you purchase a new similar product, or to a designated collection point for the recycling of waste electrical and electronic equipment (EEE). Wrong behaviour in disposal can have consequences on the environment and human health, because of the potentially hazardous substances generally associated to electric and electronic equipment. Your contribution to a correct disposal of this product will contribute to efficient use of natural resources.

## F. Warranty

Your LCJ CAPTEURS product is warranted against manufacturing defects in materials and workmanship for a period of 24 months from the date of purchase. LCJ Capteurs will repair or replace, at its discretion, faulty products free of charge at their premises. The warranty does not cover the installation labour and shipping costs of the faulty parts. A proof of purchase can be required when processing the warranty claim by written. Once LCJ Capteurs has approved the warranty claim, the sensor must be sent to their workshop address. LCJ Capteurs ensures that each wind sensor is tested and calibrated before despatch.

The warranty does not apply in the following cases:

1. Damage resulting from misuse.
2. Improper installation or inappropriate conditions of operation.
3. If the product has been damaged, opened or repaired by an unapproved agent.
4. Damage resulting from lightning, fire or any similar circumstances.

Warranty is void if operation, use, installation and technical service instructions have not been followed and if a repair has been carried out without prior agreement.

## G. Product return

Contact your dealer prior to returning a product to LCJ Capteurs. A Return Merchandise Authorisation (RMA) must be issued and received before sending a product back.

## 2. Introduction

A conventional wind vane-anemometer includes mechanical rotating parts. These parts are subject to wear and they represent sources of failure of the sensor. Our ultrasonic sensor has been designed to avoid this and to ensure reliable and stable operation. This ultrasonic wind vane-anemometer shows very stable results over a long term and with no maintenance.

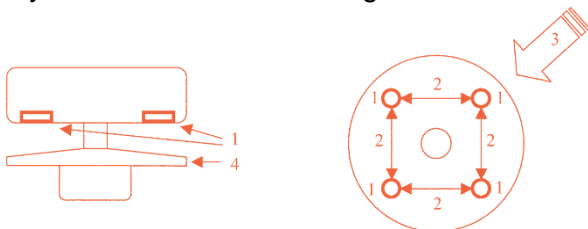

The sound (and ultrasound) is conveyed by the movement of the fluid in which it crosses. The electroacoustic transducers (1) communicate between themselves two by two using ultrasonic signals (2) to determine, following the orthogonal axes, the wave transit time differences induced by the air flow (3). The measurements are combined in

an integrated calculation to establish the wind speed and its direction in relation to a reference axis.

The temperature measurements are used for calibration corrections. The sensor's design minimises the effect of heel angle (4). The CV7 range of products features lateral transducers delivering four independent measurements.

The validity checks are used to measure head wind vectors for calculations. This method gives a sensitivity of 0.12 m/s, as well as reliability and excellent linearity up to 40 m/s (144 km/h).

LCJ Capteurs has designed and manufactured ultrasonic wind sensors since 1999. Our range of wind vane-anemometers covers the needs over many applications. They have proved their robustness and accuracy in the marine sector. They are now widely used in other fields such as weather stations, industry, public safety, sports, agriculture and so on.

At LCJ Capteurs, each sensor is fully tested before despatch and the test results are saved against

the serial number. The sensor is placed in our wind tunnel on a rotating bracket that rotates in steps of 9 degrees. This operation is controlled by computer. The sensor is first aligned at 0 degrees to the direction of air flow and then 40 measuring points are recorded for speed and angle. You can read a typical test report here on the left. The full document is available on our website.

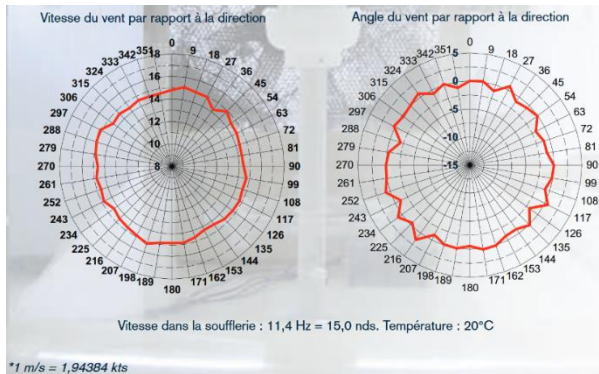

### 3. Installation

#### A. Delivery control

Before opening the box, check it carefully to spot any damage that can have occurred in transport. If the packaging is damaged, fill in a Freight Claim with full description of the problem.

#### B. Opening the box

Unpack the parcel in a dry and clean place and check the delivery:

1. CV7SF2 and its receiver.
2. Mounting bracket.
3. Alignment tool
4. User manual



Warning: Unpack the product with care to avoid any damage

#### C. Choose the best location

The choice of the appropriate installation location is crucial to get the best measurements. The location must be free of turbulence and magnetic field resulting from electricity, engines, radio transmitters, radars, etc. For mobile installations, consider that the sensor measures the apparent wind speed and angle. This has to be integrated in the data process to calculate the true wind vector.

Choose a location that is clear of any obstacle to wind. On a boat, it is at the head of mast. Secure the bracket.

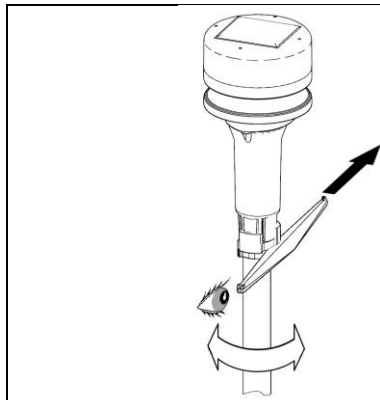

#### Alignment of the sensor

It is necessary to orientate the sensor towards the front of the boat. An alignment tool is supplied for this purpose. Clip the tool on the tube and slide it so that it snaps into the dedicated slots. Do not tamper with the slots. The tool must position itself naturally on the sensor. Align the tool - and the sensor - to the front. Use the clamping screws in the bracket to lock the sensor.



**Note:** The magnetic declination must be taken into account to reference the measurements to the geographic North.

The maximum radio range is 200 meters. The best performance is obtained with a distance of 50 meters between the wind sensor and the receiver. It should be noted that radio propagation can be disturbed by building materials (carbon, aluminium, metal, etc.). A minimum distance of 10 centimeters between the sensor tube and a conductive material is recommended. In some specific cases, there may be reception disturbances. Contact our customer service.

#### D. Wiring

The CV7SF2 includes a receiver box with a connector to connect to your application and 2 pairs of wires with connectors for battery connection.

#### E. Power supply

The PV panel ensures that the CV7SF2 operates independently. The energy is stored in a LiFePO4 battery of 3.2 V – 600 mA fitted in a 14500 box.

#### F. Connection to your application

Supply the receiver and connect your application (1):

- 1: GND
- 2: NMEA -
- 3: NMEA +
- 4: +12 V



(1): in case of USB version, skip this step and connect the cable directly to your PC.

## 4. Starting up

For a correct start, the PV module must supply at the minimum energy comparable to 50 watts per square meter solar energy.

The battery is disconnected for delivery.



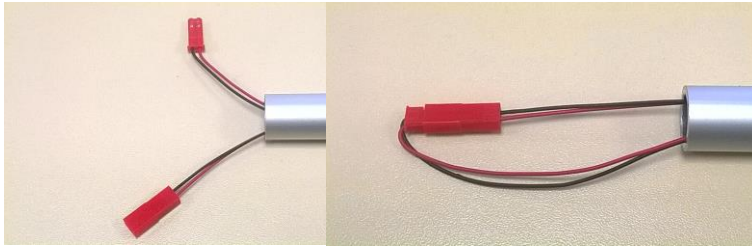

Disconnected battery

Connected battery



Then, insert the connectors inside the tube and plug the cap in.

After one minute of initialization and with enough sun exposure, your CV7SF2 is ready to operate.

## 5. Maintenance

The CV7SF2 does not require specific maintenance. Eventually a periodic cleaning of the photovoltaic panel may be necessary.



Warning: Do not use alcohol base cleaning products. Use a clean soft cloth, clear water or a neutral cleaning product.

## 6. Replacing the battery

Choose a clean and dry location to change the battery.

- |   |   |
|---|---|
| <ul style="list-style-type: none"> <li>a) Dismount the CV7SF2.</li> <li>b) Open the tube.</li> <li>c) Pull the battery's wires.</li> <li>d) Disconnect the battery.</li> <li>e) Spot the North mark on the battery's box.</li> <li>f) Unscrew the 3 screws of the battery's box:</li> </ul> | <ul style="list-style-type: none"> <li>h) Pull the battery out with the wires and connectors.</li> <li>i) Insert the wires and connectors of the new battery until they come out of the other side of the tube.</li> <li>j) Put the new battery in place.</li> <li>k) Slide the tube back to the slot while taking care of the North mark previously identified.</li> <li>l) Tighten the 3 screws.</li> <li>m) Connect the battery.</li> <li>n) Insert the wires and the connector in the tube and plug the cap.</li> <li>o) Mount the CV7SF2 back in place.</li> </ul> |
|---|---|



- g) Slide the tube along the cable to access the battery.

Note: When purchasing the battery at LCJ Capteurs, please mention the SKU: DZP\_BATT.



Use only original battery with its wires and connectors.  
Do not weld the wires directly on the battery.

## 7. Technical specifications

### A. NMEA frames

Output NMEA0183® IIMWV and WIXDR every 1 s

The NMEA sentences transmitted by the CV7SF2 are:

Wind NMEA: \$IIMWV,136.0,R,004.80,N,A*05						
Preamble	Wind angle from 000.0° to 359.0°	Wind Direction Reference	Wind speed	Wind Speed Units	Sensor Status, A = Valid, V = Alarm	Checksum
\$IIMWV	136.0	R = relative T= true	004.80	K = km/hr, M = m/sec, N = kt	A	05

Pressure, Temperature, speed NMEA: \$WIMDA,,I,1.0178,B,026,C,,C,,,C,,T,,M,009.3,N,,M*05							
Preamble	Pressure	Unit	Wind temperature	Unit	Wind speed	Units used	Checksum
\$WIMDA	1.0178	B= bar	026	C= degree	009.3	N= Kt	05

Temperature and pressure NMEA: \$WIXDR,C,007,C,,U,4.1,V,,P,1.0235,B,,*6A										
Preamble	type	Wind temperature	Units used	type	Charge voltage	Units used	type	pressure	Units used	Checksum
\$WIXDR	C	007	C	U	4.1	V= Volt	P= pressure	1.0235	B= Bar	63

Proprietary DATA: \$PLCJE,AAAA,BBB,CCC			
Preamble	Sensor number	Other data	Other data
\$PLCJE	AAAA	BBB	CCC

### B. Data features

Wind speed range	0,2-40 m/s (0,4 – 80 Knots)
Wind module resolution	0,1 m/s (0,1 Knots)
Wind module sensitivity	0,2 m/s (0,4 Knots)
Wind angle range	0-359 °
Direction resolution	1°
Direction sensitivity	+/- 1 °
Pressure: Operating range	20 kPa to 110 kPa
Pressure: Resolution	0,1 m
Operating temperature range without iceeing	-10°C to 55 °C
Sensor weight	200 gr
Environnement	Sensor : IP67

### C. Electrical specifications

Sensor power supply	photovoltaic pannel & Battery
Receiver power supply	5 - 14 VDC
Receiver consumption	6 mA
Radio signal Tx	433 mHz, 10 dbm, message length: 25 ms
Rx	Superhétérodyne ASK 433 mHz, Sensibility -110 dBm

#### D. Autonomy – consumption of sensor

Battery with full charge: 35 days without sun.

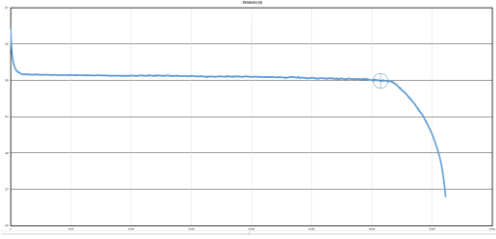

Charge-discharge cycle (day-night) :

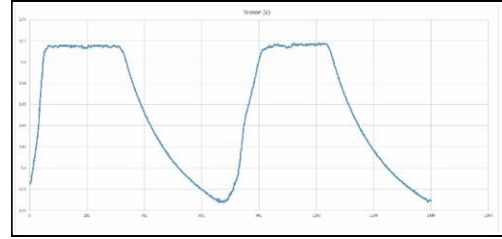

#### E. Dimensions (mm)

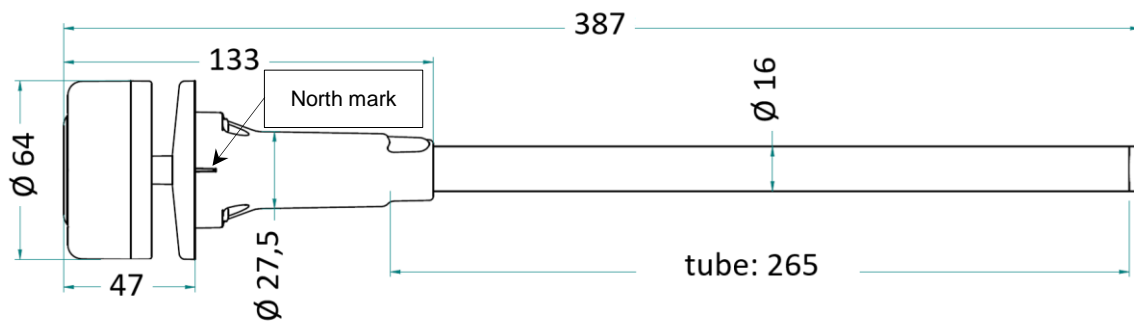

Note: never reduce the tube length under 150 mm.

## 8. Declaration of Conformity

**LCJ Capteurs certifies that the following product:**

CV7SF2, ultrasonic wind vane-anemometer

complies with the following directives:

1. Electromagnetic Compatibility: 2004/108 / CE
2. Low voltage: 2006/95 / CE

This declaration of conformity is based on the product's compliance with the following harmonised standards:

1. Electromagnetic Compatibility: EN 61326-1: 2006
2. Safety: EN 61010-1: 2001

Date of issue: 30/10/2017

Signed by:

Christophe MICHEL

Title:

CEO