

## ECDIS

Electronic Chart Display and Information System



Model:  
**FMD-3100** (with 24" wide Panel PC)

# A solution to support sm navigation to electronic



24" wide LCD (Full HD: 1920 x 1080 pixels)



## ECDIS

Electronic Chart Display and Information System

Model: FMD-3100 (with 24" wide LCD)

► **Streamlined integration into the onboard navigation system; perfectly suited for ECDIS retrofitting projects**

- 2 LAN ports and 4 serial ports are available to facilitate smooth integration into a bridge network as well as interface with onboard navigation sensors
- Flexibility in installation; supporting both table-top mounting\* as well as flush-mounting to match the space availability in the wheelhouse

\*Optional mounting bracket for table-top mounting required.



Mounting Bracket for table-top mounting

► **Instantaneous chart redraw delivered by FURUNO's advanced chart drawing engine, making redraw latency a thing of the past**



Instantaneous chart redraw

► **Suitable for both primary and back-up ECDIS**

Dual configuration of the FMD-3100 supports the vessel to go paperless\*. For those who have already installed the FMD-3200/FMD-3300 onboard the vessel, the FMD-3100 can be used as a cost-effective back-up arrangement for the FMD-3200/FMD-3300 ECDIS.

\* Please consult with flag administrations for details of their acceptable ECDIS back-up arrangement.

► **Easily interfaces with existing FAR-2x7 series Radar for:**

- Radar overlay
- Route and waypoint
- Target track info
- User Charts

exchange via Ethernet

\* Software update on FAR-21x7/FAR-28x7 series might be necessary depending on the program number.

\* for Radar overlay with analog Radar such as FAR-2xx5 series, the optional RCB-002 Radar Connection Box is required.

► **Complies with the following IMO and IEC regulations:**

- IMO A.694 (17)
- IMO MSC.191 (79)
- IMO MSC.232 (82)
- IMO MSC.302 (87)
- IEC 60945 Ed. 4
- IEC 61162-1 Ed. 5
- IEC 61162-2 Ed. 1
- IEC 61162-450 Ed. 2
- IEC 61174 Ed. 4
- IEC 62288 Ed. 2
- IEC 62923-1/-2

► **Task-based operation realized by combination of Status bar and InstantAccess bar™ providing quick access to the needed tasks/functions**

The user interface of the FMD-3100 centers on carefully organized operational tools: Status bar and InstantAccess bar™. The Status bar contains information about the operating status, and the InstantAccess bar™ contains all the tasks available. These operational tools deliver straightforward, task-based operation by which the operator can quickly perform navigational tasks without having to go deeper into an intricate menu tree.

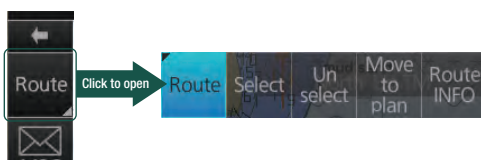
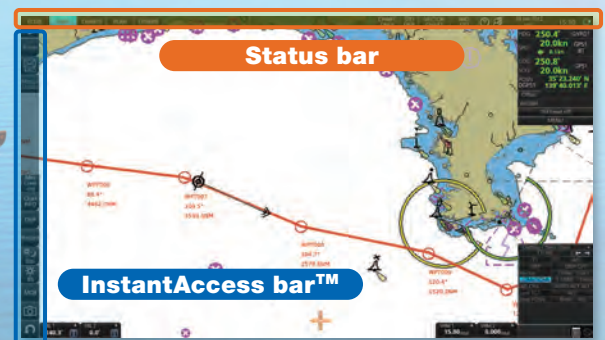

**Drop-down menu to facilitate streamlined operation**

on the buttons in the Status bar and InstantAccess bar indicates that there are hidden options of actions/tasks to be performed in the sub-layer, which can be initiated by left-clicking the buttons. This way, the operator can quickly gain access to the related tasks.



# Smooth transition from paper-based navigation

## Compatible cartography

- IHO/S-57 Edition 3 vector chart (IHO S-63 data protection scheme)
  - Admiralty Vector Chart Service by UKHO
  - C-MAP CAES
  - Jeppesen Primar ECDIS Service
- ARCS raster chart
- C-MAP Professional+\*

\*C-MAP Professional+ is a private chart, hence not construed as replacement for paper chart.



Electronic Navigation Chart (ENC)



Raster Navigation Chart (RNC)

## Compatibility with Admiralty Information Overlay (AIO) for further navigation safety

Additional AIO layer includes all Admiralty Temporary and Preliminary Notices to Mariners as well as additional ENC Preliminary Notices to Mariners, i.e., reported navigational hazards that have been incorporated into a paper chart, but have yet to be included in ENCs. The service is free of charge as part of Admiralty Vector Chart Service (AVCS) by UKHO.



AIO data layer displayed



Place the cursor on the AIO object and right-click to open the contextual menu. Select "Object INFO" to open the chart object window.

### Chart object window

On the chart object window, select the AIO object and click "OK" to view the details.

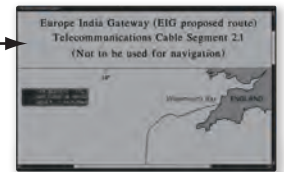

The full text of the Notice to Mariners as well as associated diagrams can be displayed subsequently.

### Processor Unit

PCU-3010  
11.2 kg 24.6 lb

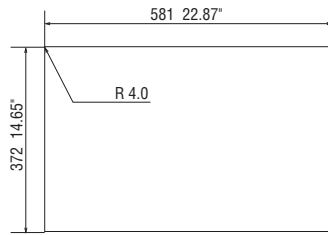
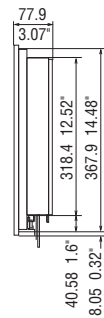
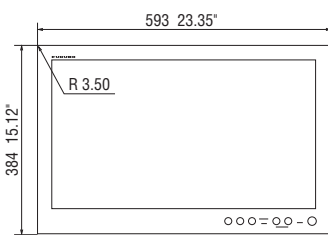

Cutout for flush mount

### Trackball Control Unit

RCU-030  
0.4 kg 0.88 lb

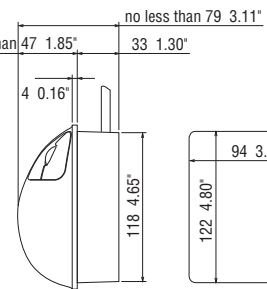
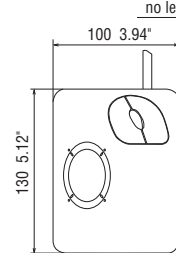

Cutout for flush mount

### Radar Connection Box

RCB-002  
3.3 kg 7.28 lb

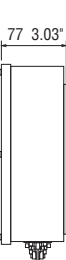
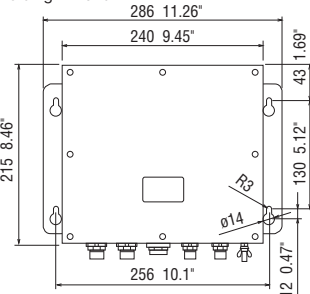

### Switching Hub

HUB-100  
1.5 kg 3.31 lb

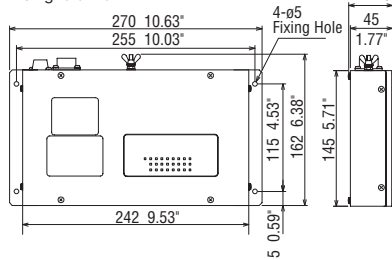

### Intelligent Hub

HUB-3000  
1.5 kg 3.31 lb

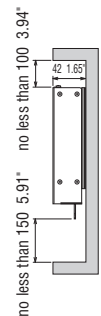
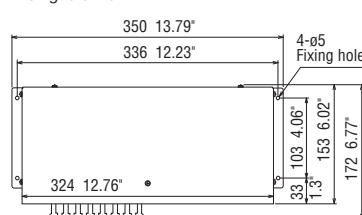

### Sensor Adapter

Serial MC-3000S  
1.5 kg 3.3 lb

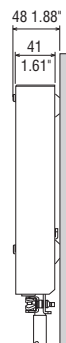
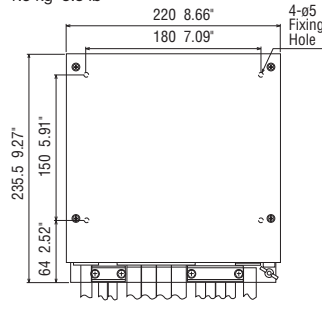

Digital In MC-3020D  
0.8 kg 1.76 lb

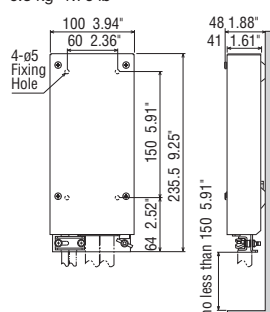

Digital Out MC-3030D  
0.8 kg 1.76 lb

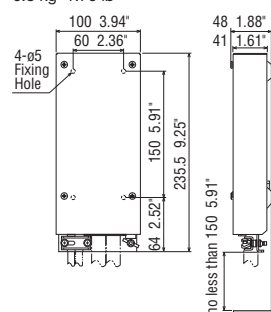

# SPECIFICATIONS

Product Name		ELECTRONIC CHART DISPLAY AND INFORMATION SYSTEM	
Standards		IMO A.694(17), IMO MSC.191(79), IMO MSC.232(82), IMO MSC.302(87)	
Monitor Unit		24" wide color LCD, Full HD (1920 x 1080 pixels)	
Chart Materials		IMO/IHO S57 edition-3 ENC vectorized material (IHO S-63 ENC data protection scheme), ARCS rasterized material, C-MAP CAES and CM-93/3 vectorized materials (optional Jeppesen e-token required)	
Display Modes	True Motion	North-up, Course-up	
	Relative Motion	North-up, Course-up, Route-up, Heading-up	
	Own Ship	Own ship's mark and numeral position in lat/lon, speed, course, etc.	
Data Presentation	Target Tracking (TT: ARPA, AIS)	Target information from AIS and TT (range, bearing, speed, course, CPA/TCPA)	
	Cursor	EBL, VRM	
	Alarm Information	Waypoint, route monitoring and several alarms	
Position Calculation		Navigation by result from external position sensor Dead reckoning with gyro and log Data from gyro, log, and position sensors to be fed to mathematical filter to generate highly accurate position and speed	
Navigation Planning		Planning by rhumb line, great circle	
Route Monitoring		Off-track display, waypoint arrival alarm, shallow depth alarm	
User Chart		User chart creation and display (up to 500 points for lines and symbols)	
MOB (Man Overboard)		Position, and other data at time of man overboard are recorded MOB mark is displayed on the screen	
Interface	DVI	1 port DVI-I for VDR 1 port DVI-D for repeater display (Video signal is identical to the one output to the main display)	
	LAN	2 ports, Ethernet 1000 Base-T (for interswitch network and sensor network)	
	USB	6 ports, USB 2.0 type-A	
	Serial I/O		2 ports, IEC61162-1/2 2 ports, IEC61162-1 Sentences (IN): ABK, ACN, ALC, ALF, ALR, ARC, CUR, DBT, DPT, DTM, ETL, GGA, GLL, GNS, HDT, HTD, MTW, MWV, NRX, NSR, OSD, PRC, RMC, ROR, ROT, RPM, RRT, RSA, THS, TLB, TRC, TRD, TTM, VBW, VDM, VDO, VDR, VHW, VTG, XDR, XTE, ZDA Sentence (OUT): ABM, ACK, ACN, ALC, ALF, ALR, ARC, BBM, DDC, EVE, HBT, HTC, OSD, RRT, RTE, VBW, VDR, VSD, WPL, XTE

## RADAR CONNECTION BOX

Radar input	2 ports
Ethernet	1 port

## INTERCONNECTION DIAGRAM

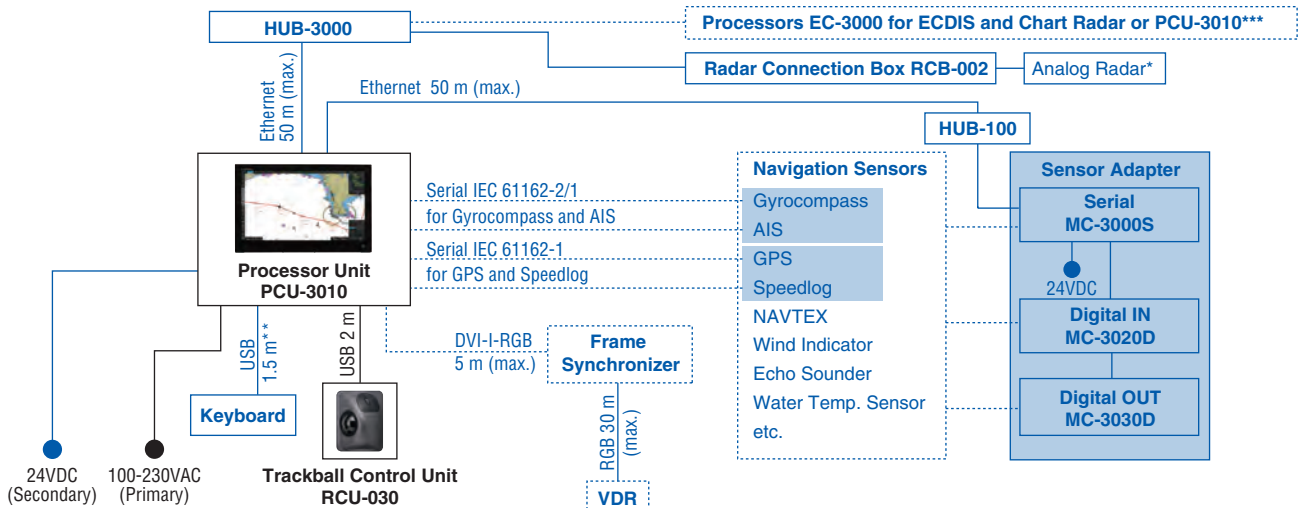

\* Please consult with your nearest distributors for details of the connectable analog Radar models.

\*\* When flush-mounted, USB extender cable connector (1 m) can be used to connect with the USB cable of the USB devices (available in standard supply).

\*\*\* Up to three units of PCU-3010 can be incorporated into the network.

— Standard supply  
— Option  
- - - - - Connectable equipment

## SENSOR ADAPTER

Control and Serial Input	LAN	1 port, Ethernet 100 Base-TX
	Serial	8 ports, IEC 61162-1/2 (4 ports), IEC 61162-1 (4 ports)
	Contact Closure	1 port for system fail, normal close or normal open
Digital Input		8 ports/unit, normal close or open, selectable
Digital output		8 ports/unit, normal close or open, selectable

## POWER SUPPLY

Main Unit	100-230 VAC 50/60 Hz (Primary), 24 VDC (Secondary)*
Radar Connection Box	12 VDC/24 VDC
Sensor Adapter	24 VDC, 1.4 A

\*AC power supply and DC power supply cannot be used concurrently.

## ENVIRONMENTAL CONDITION

Ambient Temperature	-15°C to +55°C	
Relative Humidity	93 % or less at 40°C	
Degree of Protection	Processor Unit	IP65 (front side) IP22 (back side)
	Trackball Control Unit	IP22
	Radar Connection Box	IP22
	Sensor Adapter	IP20 (IP22 with optional packing)
	Intelligent HUB	IP20 (IP22 with optional packing)
Vibration	IEC 60945 Ed. 4	

## EQUIPMENT LIST

### Standard

1	Processor Unit	PCU-3010	1 unit
2	Trackball Control Unit	RCU-030	1 unit
3	Portable DVD-ROM Drive	DVSM-PC58U2V-BKC	1 unit
4	Standard spare parts, installation materials and accessories, incl. ENC dongle*		1 set

\* Jeppesen e-token is not included.

### Option

1	Sensor Adapter		1 set
	MC-3000S Control Serial		
	MC-3020D Digital IN		
	MC-3030D Digital OUT		
2	Switching Hub HUB-100 for sensor network		1 unit
3	Intelligent Hub HUB-3000 for interswitch network		1 unit
4	Radar Connection Box RCB-002 for interface with 3rd party radar		1 unit
5	Mounting bracket for table-top mount		1 unit
6	Cable Clamp for PCU-3010		1set
7	USB Keyboard		1 unit
8	Fixing Bracket for RCU-030		1 set

Beware of similar products

All brand and product names are registered trademarks, trademarks or service marks of their respective holders.

SPECIFICATIONS SUBJECT TO CHANGE WITHOUT NOTICE

**FURUNO ELECTRIC CO., LTD.**  
Japan | www.furuno.com  
**FURUNO U.S.A., INC.**  
U.S.A. | www.furunousa.com  
**FURUNO PANAMA S.A.**  
Republic of Panama | www.furuno.com.pa  
**FURUNO (UK) LIMITED**  
U.K. | www.furuno.co.uk  
**FURUNO NORGE A/S**  
Norway | www.furuno.no

**FURUNO DANMARK A/S**  
Denmark | www.furuno.dk  
**FURUNO SVERIGE AB**  
Sweden | www.furuno.se  
**FURUNO FINLAND OY**  
Finland | www.furuno.fi  
**FURUNO POLSKA Sp. Z o.o.**  
Poland | www.furuno.pl  
**FURUNO DEUTSCHLAND GmbH**  
Germany | www.furuno.de

**FURUNO FRANCE S.A.S.**  
France | www.furuno.fr  
**FURUNO ESPAÑA S.A.**  
Spain | www.furuno.es  
**FURUNO ITALIA S.R.L.**  
Italy | www.furuno.it  
**FURUNO HELLAS S.A.**  
Greece | www.furuno.gr  
**FURUNO (CYPRUS) LTD**  
Cyprus | www.furuno.com.cy

**FURUNO SHANGHAI CO., LTD.**  
China | www.furuno.com/cn  
**FURUNO CHINA CO., LTD.**  
Hong Kong | www.furuno.com/cn  
**FURUNO KOREA CO., LTD**  
Korea  
**FURUNO SINGAPORE**  
Singapore | www.furuno.sg

**PT FURUNO ELECTRIC INDONESIA**  
Indonesia | www.furuno.id  
**FURUNO ELECTRIC (MALAYSIA) SND. BHD.**  
Malaysia | www.furuno.my