

FURUNO

OPERATOR'S MANUAL

MARINE RADAR

FAR-2218

FAR-2218-BB

FAR-2228

FAR-2228-BB

FAR-2238S

FAR-2238S-BB

FAR-2238S-NXT

FAR-2238S-NXT-BB

FAR-2258

FAR-2258-BB

FAR-2358

FAR-2318

FAR-2328

FAR-2338S

Model FAR-2338S-NXT

(FISHING SPECIFICATION)

ECF

(Elemental Chlorine Free)

The paper used in this manual
is elemental chlorine free.

FURUNO ELECTRIC CO., LTD.

9-52 Ashihara-cho,
Nishinomiya, 662-8580, JAPAN

• FURUNO Authorized Distributor/Dealer

All rights reserved. Printed in Japan

Pub. No. OME-36521-D2

(REFU) FAR-2218F

A : OCT. 2018

D2 : APR. 14, 2021



0 0 0 1 9 5 6 2 2 1 3

IMPORTANT NOTICES

General

- This manual has been authored with simplified grammar, to meet the needs of international users.
- The operator of this equipment must read and follow the instructions in this manual. Wrong operation or maintenance can void the warranty or cause injury.
- Do not copy any part of this manual without written permission from FURUNO.
- If this manual is lost or worn, contact your dealer about replacement.
- The contents of this manual and the equipment specifications can change without notice.
- The example screens (or illustrations) shown in this manual can be different from the screens you see on your display. The screens you see depend on your system configuration and equipment settings.
- Save this manual for future reference.
- Any modification of the equipment (including software) by persons not authorized by FURUNO will void the warranty.
- The following concern acts as our importer in Europe, as defined in DECISION No 768/2008/EC.
 - Name: FURUNO EUROPE B.V.
 - Address: Ridderhaven 19B, 2984 BT Ridderkerk, The Netherlands
- The following concern acts as our importer in UK, as defined in SI 2016/1025 as amended SI 2019/470.
 - Name: FURUNO (UK) LTD.
 - Address: West Building Penner Road Havant Hampshire PO9 1QY, U.K.
- InstantAccess bar™ is a registered trademark of FURUNO Electric co., Ltd.
- SDHC is a registered trademark of SD-3C, LLC.
- All brand, product names, trademarks, registered trademarks, and service marks belong to their respective holders.

How to discard this product

Discard this product according to local regulations for the disposal of industrial waste. For disposal in the USA, see the homepage of the Electronics Industries Alliance (<http://www.eiae.org/>) for the correct method of disposal.

How to discard a used battery

Some FURUNO products have a battery(ies). To see if your product has a battery, see the chapter on Maintenance. Follow the instructions below if a battery is used. Tape the + and - terminals of battery before disposal to prevent fire, heat generation caused by short circuit.

In the European Union

The crossed-out trash can symbol indicates that all types of batteries must not be discarded in standard trash, or at a trash site. Take the used batteries to a battery collection site according to your national legislation and the Batteries Directive 2006/66/EU.

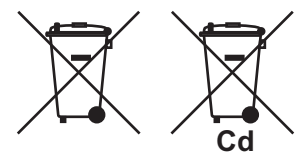

In the USA

The Mobius loop symbol (three chasing arrows) indicates that Ni-Cd and lead-acid rechargeable batteries must be recycled. Take the used batteries to a battery collection site according to local laws.

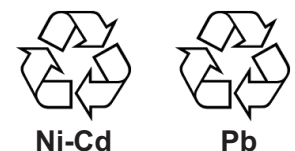



In the other countries

There are no international standards for the battery recycle symbol. The number of symbols can increase when the other countries make their own recycle symbols in the future.



SAFETY INSTRUCTIONS

The operator must read the applicable safety instructions before attempting to operate the equipment.

 DANGER	Indicates a potentially hazardous situation which, if not avoided, could result in death or serious injury.
 WARNING	Indicates a potentially hazardous situation which, if not avoided, could result in death or serious injury.
 CAUTION	Indicates a potentially hazardous situation which, if not avoided, could result in minor or moderate injury.

 Warning, Caution	 Prohibitive Action	 Mandatory Action
----------------------------------------------------------------------------------------------------	------------------------------------------------------------------------------------------------------	------------------------------------------------------------------------------------------------------

WARNING



Radio Frequency Radiation Hazard







The radar antenna emits electromagnetic radio frequency (RF) energy that can be harmful, particularly to your eyes. Never look directly into the antenna aperture from a close distance while the radar is in operation or expose yourself to the transmitting antenna at a close distance. Distances at which RF radiation level of 100, 50 and 10 W/m² are given in the table below.







Note: If the antenna unit is installed at a close distance in front of the wheel house, your administration may require halt of transmission within a certain sector of antenna revolution. This is possible. Ask your FURUNO representative or dealer to provide this feature.

	Model	Transceiver	Magnetron	Antenna*	100 W/m ²	50 W/m ²	10 W/m ²
Magnetron radar	FAR-2218(-BB) FAR-2318	RTR-105 (12 kW)	FNE1201	XN12CF	0.6 m	1.4 m	4.4 m
				XN20CF	0.4 m	0.9 m	3.0 m
				XN24CF	0.3 m	0.6 m	2.5 m
	FAR-2228(-BB) FAR-2328	RTR-106 (25 kW)	MG5436	XN12CF	1.3 m	2.7 m	9.5 m
				XN20CF	1.0 m	1.7 m	6.8 m
				XN24CF	0.7 m	1.3 m	5.5 m
	FAR-2238S(-BB) FAR-2338S	RTR-107 (30 kW)	MG5223F	SN24CF**	1.7 m	2.4 m	3.8 m
				SN30CF**	1.4 m	2.1 m	3.4 m
				SN36CF	N/A	0.5 m	4.6 m
FAR-2258(-BB) FAR-2358	RTR-122 (50 kW)	9M31	XN24AF	2.3 m	4.5 m	13.9 m	
			XN30AF	2.3 m	4.3 m	13.9 m	
Solid state radar	FAR-2238S-NXT(-BB) FAR-2338S-NXT	RTR-111 (250 W)	—	SN24CF**	N/A	N/A	N/A
				SN30CF**	N/A	N/A	N/A
				SN36CF	N/A	N/A	1.0 m

*: XN12CF: 4 ft, XN20CF: 6.5 ft, XN24CF: 8 ft, XN30AF: 10 ft, SN24CF: 8 ft, SN30CF: 10 ft, SN36CF: 12 ft.

** : Unavailable on IMO-type radars.

 WARNING	
	<p>ELECTRICAL SHOCK HAZARD. Do not open the equipment.</p> <p>Only qualified personnel should work inside the equipment.</p>
	<p>Turn off the radar power switch before servicing the antenna unit. Post a warning sign near the switch indicating it should not be turned on while the antenna unit is being serviced.</p> <p>If the antenna rotates while there is personnel nearby or servicing the antenna, injury or death may result.</p>
	<p>Do not disassemble or modify the equipment.</p> <p>Fire, electrical shock or serious injury can result.</p>
	<p>Immediately turn off the power at the ship's mains switchboard if water leaks into the equipment or the equipment is emitting smoke or fire.</p> <p>Continued use can cause fatal damage to the equipment.</p>
	<p>Keep the area around the antenna free of ropes and other items that may get tangled.</p> <p>If the antenna becomes tangled, damage to the equipment or injury to personnel may occur.</p>
	<p>Make sure no rain or water splash leaks into the equipment.</p> <p>Fire or electrical shock can result if water leaks into the equipment.</p>

 WARNING	
	<p>Use the proper fuse.</p> <p>Use of a wrong fuse can result in damage to the equipment or cause fire.</p>
	<p>Keep heater away from equipment.</p> <p>Heat can alter equipment shape and melt the power cord, which can cause fire or electrical shock.</p>
	<p>Do not place liquid-filled containers near the equipment.</p> <p>Fire or electrical shock can result if a liquid spills into the equipment.</p>
	<p>Do not operate the equipment with wet hands.</p> <p>Electrical shock can result.</p>
	<p>Before servicing the radar, turn off the appropriate external breaker.</p> <p>Power is not removed from the radar simply by turning off its power switch.</p>
	<p>This equipment has a valid latitude range of 85°N to 85°S. Operation outside of this range can result in a larger margin of error when calculating position, heading, bearing, etc.</p>

⚠ WARNING

No one navigational aid should be relied upon for the safety of vessel and crew. The navigator has the responsibility to check all aids available to confirm position. Electronic aids are not a substitute for basic navigational principles and common sense.

- ◆ This TT automatically tracks automatically or manually acquired radar targets and calculates their courses and speeds, indicating them by vectors. Since the data generated by the auto plotter are based on what radar targets are selected, the radar must always be optimally tuned for use with the auto plotter, to ensure required targets will not be lost or unwanted targets such as sea returns and noise will not be acquired and tracked.
- ◆ A target does not always mean a land-mass, reef, ships or other surface vessels but can imply returns from sea surface and clutter. As the level of clutter changes with environment, the operator should properly adjust the A/C SEA, A/C RAIN and GAIN controls to be sure target echoes are not eliminated from the radar screen.

WARNING LABEL

Warning labels are attached to the equipment. Do not remove any label. If a label is missing or damaged, contact a FURUNO agent or dealer about replacement.



**DISPLAY UNIT,
POWER SUPPLY UNIT &
PROCESSOR UNIT**

Name: Warning Label 1
Type: 86-003-1011-3
Code No.: 100-236-233-10

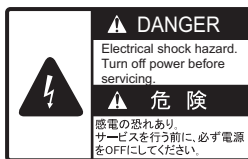

**TRANSCEIVER UNIT
(RTR-105/106/107/108/109)**

Name: Warning Label
Type: 03-160-1042-0
Code No.: 100-302-750-10

⚠ CAUTION

The plotting accuracy and response of this TT meets IMO standards. Tracking accuracy is affected by the following:

- ◆ Tracking accuracy is affected by course change. One to two minutes is required to restore vectors to full accuracy after an abrupt course change. (The actual amount depends on gyrocompass specifications.)
- ◆ The amount of tracking delay is inversely proportional to the relative speed of the target. Delay is on the order of 15 - 30 seconds for high relative speed; 30 - 60 seconds for low relative speed.
- ◆ The target tracking and pertinent vector calculation accuracy is influenced by the following:
 - Echo intensity
 - The range measurement accuracy; characterized by both random and biased measurement errors.
 - The angular measurement accuracy; characterized by beam shape, target glint and bias errors.
 - Radar transmission pulsewidth
 - Gyrocompass heading error
 - Speed log error
 - Current and wind (set & drift)
 - Course change (own ship and target)

The data generated by TT, AIS and video plotter are intended for reference only.

Refer to official nautical charts for detailed and up-to-date information.

Do not depend on one navigation device for the navigation of the vessel.

Always check your position against all available aids to navigation, for the safety of the vessel and crew.

TABLE OF CONTENTS

FOREWORD	xiv
SYSTEM CONFIGURATION	xx
1. OPERATIONAL OVERVIEW	1-1
1.1 Controls Overview	1-1
1.1.1 Control Unit RCU-014	1-1
1.1.2 Control Unit RCU-031 (C-types only)	1-4
1.1.3 Control Unit RCU-015/RCU-016	1-7
1.2 How to Turn the Radar On/Off.....	1-8
1.3 How to Adjust the Brilliance.....	1-9
1.4 Display Overview.....	1-9
1.4.1 Display examples	1-9
1.4.2 InstantAccess bar™	1-15
1.5 Menu Operations	1-17
1.5.1 How to open and close the main menu	1-17
1.5.2 How to operate the menus	1-18
1.5.3 Alphanumeric input.....	1-19
1.6 How to Use the On-screen Box Menus	1-20
1.7 [CURSOR] Menu and Cursor Operations.....	1-21
1.7.1 How to show/hide the cursor (C-type only)	1-21
1.7.2 Cursor data box.....	1-21
1.7.3 How to Use the [CURSOR] Menu	1-22
1.7.4 How to change the cursor data attributes (C-type only)	1-23
1.8 Function Keys.....	1-24
1.8.1 How to set the function key mode (C-types only).....	1-24
1.8.2 How to use the function keys	1-25
1.8.3 How to change the function(s) assigned to a key.....	1-26
1.9 How to Customize Operation.....	1-27
1.10 Heading Input	1-30
1.10.1 How to select the data source for heading input	1-30
1.10.2 How to adjust for magnetic correction (C-types only).....	1-30
1.11 How to Set Own Ship's Speed	1-31
1.11.1 Automatic speed input (log or EPFS navigator)	1-31
1.11.2 Manual speed input.....	1-32
1.12 Own Ship Position	1-33
1.12.1 How to set the Own Ship position	1-33
1.12.2 How to set the display format for position data (C-types only)	1-34
1.12.3 How to select the datum to use for positioning (C-types only)	1-34
1.13 Date and Time	1-35
1.13.1 How to switch between UTC and local date/time	1-35
1.13.2 How to adjust the local time	1-35
1.13.3 How to change the date/time display format (C-types only).....	1-36
1.14 User Settings (IMO-types only)	1-36
1.14.1 How to reset the user settings.....	1-38
1.14.2 How to save/load user settings	1-38
1.15 How to Start/Stop Transmission	1-39
1.16 How to Tune the Receiver (Magnetron Radars Only)	1-40
1.16.1 How to select the tuning method	1-40
1.16.2 How to initialize tuning.....	1-40
1.16.3 How to tune the receiver manually	1-41
1.17 How to Select a Pulselength.....	1-41
1.17.1 How to select a pulselength	1-41

TABLE OF CONTENTS

1.17.2	How to change the preset pulselength.....	1-42
1.18	MOB Mark.....	1-42
1.19	How to Adjust Sensitivity.....	1-43
1.20	How to Reduce Sea Clutter.....	1-44
1.20.1	How to select the method of clutter adjustment.....	1-44
1.20.2	How to fine-tune sea clutter reduction.....	1-44
1.20.3	How to manually reduce sea clutter.....	1-45
1.20.4	How to use the BERTHING STC function.....	1-45
1.21	How to Reduce Rain Clutter.....	1-46
1.21.1	How to select the method of rain clutter reduction.....	1-46
1.21.2	How to manually reduce the rain clutter.....	1-46
1.22	Interference Rejector.....	1-48
1.23	Echo Stretch.....	1-49
1.24	Echo Averaging.....	1-50
1.25	Automatic Clutter Elimination (ACE) Function.....	1-52
1.25.1	How to turn the Automatic Clutter Elimination (ACE) function on/off.....	1-52
1.25.2	How to adjust the gain in Automatic Clutter Elimination (ACE) mode.....	1-52
1.25.3	How to get high sensitivity.....	1-53
1.25.4	How to suppress false echoes.....	1-53
1.26	Noise Rejector.....	1-54
1.27	Wiper.....	1-54
1.28	How to Preset Controls for a Specific Navigation Purpose.....	1-55
1.28.1	How to select a customized echo.....	1-58
1.28.2	How to edit a customized echo.....	1-59
1.28.3	How to restore a user customized echo to the saved settings.....	1-60
1.28.4	How to restore a user customized echo to the factory default settings.....	1-60
1.28.5	How to edit the available customized echoes.....	1-61
1.28.6	How to change the name of a customization (C-types only).....	1-61
1.28.7	How to link the customization with a range (C-types only).....	1-62
1.29	How to Reject Second-trace Echoes.....	1-63
1.30	Orientation Modes.....	1-64
1.30.1	How to select an presentation mode.....	1-64
1.30.2	Description of presentation modes.....	1-64
1.31	How to Select a Range Scale.....	1-66
1.32	How to Measure Range.....	1-67
1.32.1	How to show/hide the range rings.....	1-67
1.32.2	How to measure range with the variable range marker (VRM).....	1-67
1.32.3	How to set the VRM unit of measurement (C-types only).....	1-69
1.32.4	How to set the short distance measurement unit (C-types only).....	1-69
1.32.5	How to show TTG to VRM.....	1-70
1.33	How to Measure Bearing.....	1-70
1.33.1	Methods to measure bearing.....	1-71
1.33.2	True or relative bearing.....	1-72
1.34	Collision Assessment by Offset EBL.....	1-73
1.34.1	How to assess risk of collision using the offset EBL.....	1-73
1.34.2	How to set the origin point reference for EBL OFFSET.....	1-74
1.35	How to Measure Range and Bearing Between Two Targets.....	1-75
1.36	How to Off-Center the Display.....	1-78
1.36.1	How to off-center the display from the control unit (RCU-014/RCU-031).....	1-78
1.36.2	How to off-center the display from the on-screen menu.....	1-79
1.37	Target Trails.....	1-79
1.37.1	True or relative trails.....	1-79
1.37.2	Trail time.....	1-81
1.37.3	Trail gradation.....	1-82
1.37.4	Trail level.....	1-82
1.37.5	Narrow trails (C-type only).....	1-83

1.37.6	How to hide the trails temporarily	1-83
1.37.7	Trail stabilization in true motion	1-83
1.37.8	How to erase/restart trails	1-84
1.37.9	How to prevent sea clutter in true trails	1-84
1.37.10	How to show/hide OS trails	1-85
1.37.11	How to show/hide land trails (C-type only)	1-85
1.37.12	How to set the trail length (C-type only)	1-86
1.37.13	How to set the trail color (C-type only)	1-86
1.37.14	How to remove the colors from a section of a multicolor trail (C-type only)	1-87
1.37.15	How to offset the colors for multicolored trail (C-type only)	1-88
1.38	Target Analyzer (C-type only).....	1-89
1.38.1	How to activate/deactivate the target analyzer.....	1-90
1.39	Target Alarm.....	1-91
1.39.1	How to set a target alarm	1-91
1.39.2	How to mute the target alarm	1-92
1.39.3	How to deactivate a target alarm.....	1-92
1.39.4	How to change target alarm attributes	1-92
1.40	PI (Parallel Index) Lines	1-93
1.40.1	How to show/hide the PI lines	1-93
1.40.2	How to set the maximum number of lines to display	1-93
1.40.3	How to change PI line bearing and interval	1-94
1.40.4	How to change the PI line bearing reference (C-type only).....	1-94
1.40.5	How to change the PI line orientation.....	1-95
1.40.6	How to reset the PI lines to default (ship's heading)	1-95
1.40.7	How to change PI line length.....	1-96
1.40.8	How to change the PI line color (C-types only)	1-96
1.41	How to Use the Net (Diamond) Cursor (C-type only)	1-97
1.41.1	How to activate the net cursor	1-97
1.41.2	How to set the net cursor dimensions and orientation	1-98
1.42	Circle Cursor (C-types only)	1-99
1.43	Zoom	1-100
1.44	How to Use Marks	1-101
1.44.1	Heading line mark	1-101
1.44.2	How to hide/show the stern mark	1-102
1.44.3	North mark.....	1-102
1.44.4	Bearing ring	1-103
1.44.5	How to set up the own ship mark	1-104
1.44.6	How to set the barge marker	1-104
1.44.7	Antenna mark	1-105
1.45	Drop Mark.....	1-105
1.45.1	How to inscribe a drop mark.....	1-106
1.45.2	How to erase drop marks	1-106
1.46	Brilliance and Color Schemes	1-106
1.46.1	How to select a brilliance and color scheme	1-106
1.46.2	How to change the color schemes settings	1-107
1.46.3	How to change the color schemes settings	1-108
1.47	How to Display and Set Up Navigational Data	1-109
1.47.1	How to set up the navigational data	1-109
1.47.2	How to display navigational data	1-110
1.48	How to Use the Information Box.....	1-110
1.49	Interswitch	1-113
1.49.1	How to display antenna information	1-113
1.49.2	How to preset antenna and display combinations	1-114
1.49.3	How to clear the interswitch	1-116

TABLE OF CONTENTS

1.50	Performance Monitor.....	1-116
1.50.1	How to activate/deactivate the performance monitor.....	1-116
1.50.2	How to check the radar's performance.....	1-118
1.51	How to Change the Reference Position.....	1-119
1.52	Anchor Watch.....	1-120
1.53	Alerts.....	1-121
1.53.1	What is an alert?.....	1-121
1.53.2	Alert box overview.....	1-122
1.53.3	How to silence the buzzer.....	1-122
1.53.4	How to acknowledge an alert.....	1-122
1.53.5	Alert list.....	1-123
1.53.6	Alert icons and their meanings.....	1-124
1.54	Icing Prevention.....	1-125
1.55	How to Select an Echo Display Area (C-type Only).....	1-126
1.56	How to Use the Watch Alert.....	1-126
1.57	Loran Decca Setup (C-types Only).....	1-127
1.58	How to Manage SD Card Data.....	1-129
1.58.1	Formatting the SD card.....	1-129
1.58.2	Cautionary notes on handling SD cards.....	1-129
1.58.3	Compatible SD cards.....	1-129
1.58.4	How to insert SD cards.....	1-130
1.58.5	How to remove SD cards.....	1-130
1.58.6	How to save data to an SD card (IMO-types only).....	1-131
1.58.7	How to read (load) data from an SD card (IMO-types only).....	1-131
1.58.8	How to delete data from an SD card (IMO-types only).....	1-131
1.59	Internal Memory (C-types only).....	1-132
1.59.1	How to save data to the internal memory.....	1-132
1.59.2	How to view the contents of the internal memory.....	1-134
1.59.3	How to load the contents of the internal memory.....	1-135
1.59.4	How to delete the contents of the internal memory.....	1-136
1.59.5	How to backup data in the internal memory.....	1-137
1.59.6	How to load backup data from the internal memory.....	1-138
1.60	USB Flash Memory (C-types only).....	1-139
1.60.1	USB Flash memory connection.....	1-139
1.60.2	How to remove the USB flash memory safely.....	1-139
1.60.3	How to save data to the USB flash memory.....	1-140
1.60.4	How to load data from the USB memory.....	1-141
1.60.5	How to transfer USB data to the internal memory.....	1-143
1.60.6	How to save the backup data to the USB flash memory.....	1-144
1.60.7	How to load backup data from the USB flash memory.....	1-145
1.60.8	How to import data from other equipment.....	1-145
1.61	How to Take a Screenshot.....	1-147
2.	RADAR OBSERVATION.....	2-1
2.1	General.....	2-1
2.1.1	Minimum range.....	2-1
2.1.2	Maximum range.....	2-1
2.1.3	X-band and S-band.....	2-2
2.1.4	Radar resolution.....	2-2
2.1.5	Bearing accuracy.....	2-3
2.1.6	Range measurement.....	2-3
2.2	False Echoes.....	2-3
2.3	SART (Search and Rescue Transponder).....	2-5
2.3.1	SART description.....	2-5
2.3.2	How to show SART marks on the radar display.....	2-6
2.3.3	General remarks on receiving SARTs.....	2-6

2.4	RACON.....	2-7
2.5	Radar Target Enhancer (RTE)	2-7
2.6	Solid state radar	2-8
3.	TARGET TRACKING (TT).....	3-1
3.1	Precautions when Using Target Tracking.....	3-1
3.2	TT Controls.....	3-2
3.3	How to Show/Hide the TT Symbols.....	3-2
3.4	How to Select the TT mode.....	3-3
3.4.1	How to setup the acquisition method	3-3
3.4.2	How to manually acquire targets	3-4
3.4.3	How to automatically acquire targets	3-4
3.5	How to Enter Own Ship Speed.....	3-5
3.5.1	Echo-referenced speed input	3-5
3.6	How to Cancel Target Tracking.....	3-7
3.6.1	How to cancel tracking for individual TT targets.....	3-7
3.6.2	How to cancel tracking for all TT targets	3-7
3.7	Lost Target	3-8
3.7.1	How to set the lost target filter	3-8
3.7.2	How to enable/disable the lost target alert	3-8
3.8	TT Symbols and Attributes	3-9
3.8.1	How to adjust symbol brilliance	3-9
3.8.2	How to set the symbol color	3-9
3.8.3	How to set the symbol size (C-types only)	3-10
3.8.4	How to select a TT symbol (C-type only)	3-10
3.8.5	How to change the attributes for a TT symbol preset.....	3-11
3.9	How to Display/Remove Target Data	3-13
3.9.1	TT pop up information	3-13
3.9.2	How to show target data in the data display area	3-14
3.9.3	How to display, hide and sort the target list.....	3-15
3.10	Vector Modes	3-17
3.10.1	Description of vectors.....	3-17
3.10.2	Vector mode and vector length	3-19
3.10.3	How to change the vector appearance (C-types only)	3-19
3.11	Past Position Display.....	3-20
3.11.1	How to display past position points and select the plotting interval.....	3-20
3.11.2	How to select the number of past position points to be displayed.....	3-20
3.11.3	How to change the color of TT tracks (C-types only)	3-21
3.12	Set and Drift.....	3-21
3.13	Collision Alarm (CPA, TCPA)	3-22
3.13.1	How to set the CPA and TCPA ranges	3-22
3.13.2	How to acknowledge the TT collision alarm	3-23
3.14	Acquisition Zone	3-23
3.14.1	How to enable the acquisition zones.....	3-23
3.14.2	How to activate the first acquisition zone (AZ1)	3-24
3.14.3	How to set a polygon acquisition zone (AZ2)	3-24
3.14.4	How to sleep/deactivate an acquisition zone	3-25
3.14.5	How to acknowledge the acquisition zone alert	3-25
3.14.6	How to select the target type to acquire (C-types only).....	3-25
3.14.7	How to change the acquisition zone reference	3-25
3.14.8	How to set acquisition zone shape and stabilization	3-26
3.15	Trial Maneuvers (IMO-types only)	3-27
3.15.1	Types of trial maneuvers	3-27
3.15.2	How to perform a trial maneuver	3-28
3.15.3	How to stop the trial maneuver.....	3-30
3.16	TT System Messages.....	3-31

TABLE OF CONTENTS

3.17	TT Simulation Mode	3-32
3.18	Criteria for Tracking Target Selection	3-33
3.19	Factors Affecting Target Tracking	3-34
4.	AIS OPERATION	4-1
4.1	Controls for AIS	4-2
4.2	How to Select the AIS Display Mode	4-3
4.3	AIS Symbols and Their Meanings	4-3
4.4	How to Use the AIS Display Filter	4-4
4.5	How to Activate AIS Targets	4-5
4.5.1	How to activate specific targets manually	4-5
4.5.2	How to set the AIS auto activate function	4-6
4.6	How to Sleep AIS Targets	4-7
4.6.1	How to sleep individual AIS targets	4-7
4.6.2	How to sleep all AIS targets	4-8
4.7	How to Set Up For a Voyage	4-8
4.7.1	How to access the [VOYAGE DATA] menu	4-8
4.8	How to Display AIS Target Data	4-10
4.8.1	AIS pop-up information	4-10
4.8.2	How to display basic AIS target data	4-11
4.8.3	How to display expanded AIS target data	4-12
4.8.4	How to remove target data from the display area	4-12
4.9	How to Change AIS Symbol Attributes	4-13
4.9.1	How to adjust the AIS symbol brilliance	4-13
4.9.2	How to change the color of the AIS symbol	4-13
4.9.3	How to change the color of the ATON symbol	4-14
4.9.4	How to change the size of the AIS symbol	4-14
4.9.5	How to customize the AIS symbol display (C-types only)	4-14
4.9.6	How to edit or remove AIS customizations (C-types only)	4-15
4.9.7	How to show/hide the customized AIS name (C-types only)	4-16
4.10	Past Position Display	4-16
4.10.1	How to display past position points and select the plotting interval	4-16
4.10.2	How to select the number of past position points to be displayed	4-17
4.10.3	Past position display orientation	4-17
4.10.4	Stabilization in true motion	4-17
4.10.5	How to set the AIS track color (C-types only)	4-17
4.11	Lost Target	4-18
4.11.1	How to set the lost target filter	4-18
4.11.2	How to enable/disable the lost target alert	4-19
4.12	ROT Setting	4-19
4.13	AIS Collision Alarm (CPA, TCPA)	4-20
4.13.1	How to set CPA and TCPA	4-20
4.14	How to Associate TT and AIS Targets	4-21
4.15	How to View Own Ship Data	4-23
4.16	How to Use AIS Messages	4-24
4.16.1	How to create and save messages	4-24
4.16.2	How to transmit messages	4-25
4.16.3	How to view messages	4-26
4.16.4	How to set up the AIS message notification	4-26
4.16.5	How to display AIS alert messages	4-27
4.17	AIS System Messages	4-27
5.	PLOTTER OPERATION (IMO-TYPES)	5-1
5.1	Orientation Modes	5-1
5.2	How to Select a Mark Type	5-1
5.3	How to Select the Mark Inscription Position	5-2

5.4	Radar Map.....	5-3
5.4.1	How to show/hide the radar map.....	5-3
5.4.2	How to inscribe marks.....	5-3
5.4.3	How to delete marks.....	5-5
5.4.4	How to align the radar map.....	5-6
5.5	Origin Mark.....	5-7
5.5.1	How to inscribe origin marks.....	5-7
5.5.2	How to set origin mark stabilization.....	5-8
5.5.3	How to delete origin marks.....	5-8
5.6	How to Change the Shape of the Own Ship Mark.....	5-9
5.7	How to Use ECDIS Chart Marks.....	5-10
5.8	Own Ship Track.....	5-11
5.8.1	How to show/hide tracks.....	5-11
5.8.2	How to set the plotting interval.....	5-12
5.8.3	How to delete tracks.....	5-12
5.9	How to Use Waypoints.....	5-13
5.9.1	How to set the data source for waypoints.....	5-13
5.9.2	How to enter waypoints.....	5-13
5.9.3	How to edit waypoints.....	5-14
5.9.4	How to erase waypoints.....	5-15
5.9.5	How to display the waypoint list.....	5-16
5.9.6	How to show/hide the waypoint name/number.....	5-16
5.10	Routes.....	5-17
5.10.1	How to set/edit an internal route.....	5-17
5.10.2	How to display routes.....	5-18
5.10.3	How to skip a waypoint.....	5-18
5.10.4	How to set the route width.....	5-19
5.10.5	How to show/hide the turning line.....	5-19
5.10.6	How to use the waypoint arrival distance function.....	5-20
5.10.7	How to delete internal routes.....	5-20
5.10.8	How to view the routes list.....	5-21
5.11	How to Show/Hide Grid Lines.....	5-21
6.	PLOTTER OPERATION (C-TYPES).....	6-1
6.1	Tracks.....	6-1
6.1.1	Symbols.....	6-1
6.1.2	How to show/hide ships' tracks.....	6-3
6.1.3	How to set own ship track recording.....	6-5
6.1.4	How to stop and re-start tracks.....	6-6
6.1.5	How to change track color.....	6-6
6.1.6	How to show/hide own track based on color.....	6-11
6.1.7	How to change the track line.....	6-12
6.1.8	How to set tracks recording method and interval.....	6-13
6.1.9	How to delete own ship tracks.....	6-14
6.1.10	How to edit own ship's tracks.....	6-16
6.1.11	How to view information for consorts and GPS buoys.....	6-17
6.1.12	How to delete other ship's tracks.....	6-19
6.2	Marks.....	6-20
6.2.1	How to set up marks.....	6-20
6.2.2	How to enter marks and lines.....	6-22
6.2.3	How to delete marks and lines.....	6-26
6.2.4	How to edit marks and lines.....	6-28
6.2.5	How to view mark and line information.....	6-29
6.2.6	Mark filter.....	6-31
6.3	Origin Marks.....	6-36
6.3.1	How to set up an origin mark.....	6-36

TABLE OF CONTENTS

6.3.2	How to enter an origin mark.....	6-37
6.3.3	How to delete origin marks.....	6-38
6.3.4	How to set a comment for origin marks.....	6-38
6.4	Waypoints	6-39
6.4.1	How to create a waypoint.....	6-39
6.4.2	How to edit a waypoint.....	6-45
6.4.3	How to delete a waypoint.....	6-45
6.4.4	How to search for a waypoint.....	6-46
6.4.5	How to set the voyage speed for calculations.....	6-47
6.4.6	How to view waypoint information.....	6-47
6.4.7	How to change the on-screen size of waypoint indications.....	6-48
6.4.8	How to change the way waypoint names are displayed	6-48
6.4.9	How to use external waypoints	6-49
6.5	Routes.....	6-50
6.5.1	How to create a route.....	6-50
6.5.2	How to edit a route	6-54
6.5.3	How to delete a route	6-55
6.5.4	How to search for a route.....	6-55
6.5.5	How to set the voyage speed for calculations.....	6-56
6.5.6	How to use external routes	6-56
6.6	Destinations	6-57
6.6.1	How to set up GOTO points.....	6-57
6.6.2	How to set a waypoint as a destination.....	6-59
6.6.3	How to set a route as a destination.....	6-61
6.6.4	How to set up the waypoint data display.....	6-64
6.6.5	How to stop navigation to a destination	6-65
6.7	Plotter-related alerts.....	6-65
6.7.1	How to set waypoint arrival/departure alerts	6-65
6.7.2	How to set mid-route alerts	6-66
6.7.3	How to set XTE/border route alerts.....	6-67
6.7.4	How to active/deactivate intrusion alerts.....	6-68
6.7.5	How to set temperature alerts	6-68
6.7.6	How to set sheer alerts	6-69
6.7.7	How to set depth alerts	6-69
6.8	Chart Functions.....	6-70
6.8.1	How to show/hide the chart.....	6-70
6.8.2	How to align the chart position	6-71
6.8.3	How to select the chart type.....	6-72
6.8.4	Chart settings menu	6-73
6.8.5	How to show/hide land mass emphasis	6-74
6.8.6	How to set up depth lines.....	6-75
6.8.7	How to display detailed depth lines.....	6-76
6.8.8	How to check your charts/symbol versions	6-77
6.9	Grid Lines.....	6-77
7.	MAINTENANCE, TROUBLESHOOTING.....	7-1
7.1	Periodic Maintenance Schedule.....	7-2
7.2	How to Replace the Fuse.....	7-3
7.3	Life Expectancy of Major Parts	7-4
7.4	Trackball Maintenance	7-4
7.5	Easy Troubleshooting	7-5
7.6	Advanced-level Troubleshooting.....	7-6
7.7	Diagnostics.....	7-8
7.8	Sentence Monitor	7-13
7.9	Fallback Arrangements	7-14

APPENDIX 1 MENU TREEAP-1
APPENDIX 2 LONGITUDE ERROR TABLE (96 NM SCALE)AP-15
APPENDIX 3 ALERT CODES, MESSAGES & MEANINGSAP-17
APPENDIX 4 DATA COLOR AND MEANING.....AP-26
APPENDIX 5 ABBREVIATIONS.....AP-27
APPENDIX 6 SYMBOLS.....AP-32
APPENDIX 7 PARTS LOCATIONAP-37
APPENDIX 8 RADIO REGULATORY INFORMATIONAP-45

SPECIFICATIONS SP-1

INDEX IN-1

FOREWORD

A Word to the Owner of FAR-22x8/23x8 Series Marine Radar

Congratulations on your choice of the FURUNO FAR-22x8/FAR-23x8 series of radars. We are confident you will see why FURUNO has become synonymous with quality and reliability.

Since 1948, FURUNO Electric Company has enjoyed an enviable reputation for innovative and dependable marine electronics equipment. This dedication to excellence is furthered by our extensive global network of agents and dealers.

Your radar is designed and constructed to meet the rigorous demands of the marine environment. However, no machine can perform its intended function unless installed, operated and maintained properly. Please carefully read and follow the recommended procedures for operation and maintenance. We would appreciate hearing from you, the end-user, about whether we are achieving our goal.

Thank you for considering and purchasing FURUNO equipment.

Features

- The FAR-2xx8 series consists of the following models and configurations:

Magnetron radar

Model	Frequency band	Size of monitor unit*	Output power	Transceiver location
FAR-2218	X-band	19.0"	12 kW	Antenna unit
FAR-2218-BB		Local supply	12 kW	
FAR-2318		23.1"/27"	12 kW	
FAR-2228		19.0"	25 kW	
FAR-2228-BB		Local supply	25 kW	
FAR-2328		23.1"/27"	12 kW	
FAR-2258		19.0"	50 kW	
FAR-2258-BB		Local supply	50 kW	
FAR-2358		23.1"/27"	50 kW	
FAR-2238S	S-band	19.0"	30 kW	Antenna unit
FAR-2238S-BB		Local supply	30 kW	
FAR-2338S		23.1"/27"	30 kW	

Solid state radar

Model	Frequency band	Size of monitor unit*	Output power	Transceiver location
FAR-2238S-NXT	S-band	19.0"	250 W	Antenna unit
FAR-2238S-NXT-BB		Local supply	250 W	Antenna unit
FAR-2338S-NXT		23.1"/27"	250 W	Antenna unit

*: Viewing distances are as follows: MU-190/MU-270W: 1020 mm; MU-231: 1200 mm.

- Two methods of operation are available: RCU-014/RCU-031 (standard supply control unit) and RCU-015/RCU-016 (optional trackball unit). The ergonomically designed palm rest on the RCU-015/RCU-016 makes them easy to use.
- Simple operation with "point-and-click" menu functionality.
- All functions can be accessed using only the trackball unit.

- TT, AIS*, Radar Map and Interswitch are supplied as standard.
*: Requires connection to a compatible AIS transponder.
- FURUNO's unique Target Analyzer function helps to find targets in high noise areas (rain/snow), or where there is interference from surface reflections (C-types only).
- The Automatic Clutter Elimination (ACE) function detects sea and rain clutter from received echoes' and automatically reduces sea and rain clutter accordingly.
- Targets activate the user-set alarm/acquisition zone when entering or exiting the zone.
- CPA/TCPA alarms.
- Radar screen can be overlaid with the chart display (C-types only).
- Full plotter functionality (C-types only).
- The FAR-2xx8 series complies with MED 2014/90/EU* and also the following directives: IEC62388, IEC 62288, IMO MSC. 192(79)*.
*: Excludes FAR-2258(-BB) and FAR-2358.

Radar Type and Function Availability

The software for advanced fishing specifications is available in two specification types, and function availability depends on specification type. The table below shows the function that have limited availability. This manual provides descriptions for all functions of this radar series, and we have endeavored to denote in the text those functions that have limited availability. For detailed information on the function availability, see the menu tree at the back of this manual.

Type abbreviations and their meanings

- IMO: Meets the IMO requirements and is compliant with IMO regulations
- C: Advanced fishing specifications

Function availability and specification type

Function	Type	
	IMO	C
Echo area configuration	No	Yes
Target Analyzer	No	Yes
Customized echo - assign name	No	Yes
Trails - 5-step gradation	No	Yes
Trail Eraser	No	Yes
Trails - Long	No	Yes
Trails - Hide	No	Yes
Trails - Narrow	No	Yes
Trails - Color	No	Yes
Echo Average level 4	No	Yes
True view	No	Yes
Marks - No. available	Max. 20,000	Max. 30,000
Area Marks	No	Max. 50
ECDIS marks	Yes	No
Marks filter	No	Yes
Mark information display	No	Yes
Mark comment display	No	Yes
Own track - Points	Max. 20,000	Memory capacity: Max. 30,000 Display capacity: Max. 10,000
Own track - Edit	No	Yes

FOREWORD

Function	Type	
	IMO	C
Own track - Color	No	Yes
Own track - Stop/start plotting	No	Yes
Own track - Save intervals	[OFF], [DRAW ONLY] with intervals of 10s, 30s, 1min, 2min, 3min, 6min, 15min	[OFF], [TRACK INTERVAL 1], [TRACK INTERVAL 2] with time intervals of 0s to 59m59s or distance intervals of 0NM to 9.99NM.
Other tracks - Points	No	<ul style="list-style-type: none"> • TT targets: Memory capacity: Max. 100,000 Display capacity: Max. 10,000 • AIS targets: Memory capacity: Max. 10,000 Display capacity: Max. 10,000 • Consort vessels: Memory capacity: Max. 10,000 Display capacity: Max. 1,000 • GPS buoys: Memory capacity: Max. 10,000 Display capacity: Max. 1,000
Other tracks - Edit	No	Yes
Other tracks - Stop/start plotting	No	Yes
Other tracks - Save intervals	No	[OFF], [TRACK INTERVAL 1], [TRACK INTERVAL 2] with time intervals of 0s to 59m59s or distance intervals of 0NM to 9.99NM.
Chart Display	No	Yes
Individual contour line display	No	Yes
WPT - No. of marks	Max. 200 (+1 external)	Max. 3,500 (+100 external)
PI lines - No. of lines	Max. 6	Max. 11
PI lines - Mode	No	Yes
PI lines - Linked to EBL/VRM	No	Yes
PI lines - Color	No	Yes
Range	[0.125], [0.25], [0.5], [0.75], [1.5], [3], [6], [12], [24], [48], [96]	[0.025]* ¹ , [0.05]* ¹ , [0.075]* ¹ , [0.1m]* ¹ , [0.125]* ² , [0.25], [0.5], [0.75], [1], [1.5], [2], [3], [4], [6], [8], [12], [16], [24], [32], [48], [96], [120]* ³
Range unit	[NM] only	[NM], [SM], [km], [kyd]
Range rings - No. available	Fixed	Max. 6 rings
Range rings - 32 point display	No	Yes
VRM - Unit selection	No	Yes
VRM - Close distance unit	No	Yes
Cursor - Range unit selection	No	Yes
Cursor - Size	No	Yes
Cursor - Enlarged information box	No	Yes
Cursor - Color	No	Yes
Net Cursor	No	Yes
Circle Cursor	No	Yes
Plotter-related alerts (XTE, arrival, departure, intrusion, temp., sheer, depth)	No	Yes

Function	Type	
	IMO	C
Acquisition zone - Check area around ship	No	Yes
TT - Symbol selection, symbol color, individual settings for symbols	No	Yes
TT - Vector line type	No	Yes
TT - Acquisition by target type	No	Yes
TT - Lat./Long. data display	No	Yes
TT - Display up to 5 targets' data in information area	No	Yes
AIS - Symbol color	No	Yes
GPS buoy display	No	Yes
Consort vessel - display	No	Yes
Trial Maneuver	Yes	No
Data import from other equipment	No (File conversion required)	Yes
Magnetic bearing input and display	No	Yes
Alternative positioning systems (LO-RAN, DECCA, TOKYO datum)	No	Yes
Date/time display format selection	No	Yes
Echoes in multi-color	No	Yes
Echoes in amber color	No	Yes
Chart/Plotter brilliance adjustment	No	Yes
User settings, Pilot settings	Yes	No
Shuttle Ferry mode	Yes	No
Simplified screen layout	No	Yes
Display Scroll	No	Yes
Customizable [CURSOR] menu	No	Yes
Function keys - [CURSOR CENTER/ DISPLAY MODE] function	No	Yes
Show/hide the cursor	No	Yes
Function keys - Assign multiple functions	No	Yes

*1: Available only when radar is transmitting.

*2: Not available if using [km/kyd] range units and radar is transmitting.

*3: Available only when the range unit is set to [NM] or [SM].

Signal processing functions

This radar has the signal processing functions listed in the table below.

Function	Description	Reference
Interference rejector	Suppresses interference by other radars. Interference received simultaneously from multiple radars may be difficult to reduce.	See section 1.22
Echo stretch	Enlarges target echoes, especially small echoes. Suppress interference, sea clutter and rain clutter before using echo stretch, to prevent enlargement of unwanted echoes.	See section 1.23
Echo averaging	The radar samples echoes with each scan. Targets that show a large change with each scan are judged as clutter and are reduced to display only echoes from legitimate targets.	See section 1.24
Automatic clutter elimination	Discriminates clutter from the radar echo, then reduces the clutter automatically.	See section 1.25
Noise rejector	Reduces white noise then improves the on-screen S/N ratio by processing the weighted moving average filter for the received echoes in the range direction. Use this function with caution. Weak target echoes may disappear from the screen or the range resolution may worsen.	See section 1.26

Program numbers

Please access the following URL if you need software information:

http://www.furuno.com/en/merchant/radar/FAR-22x8_23x8/#SoftwareVersion

System	Program no.	Version no.	Remarks
Antenna unit (common to all antennas)			
SPU	0359281	01.xx	For magnetron radar (other than FAR-2258, FAR-2258-BB and FAR-2358)
SPU	0359286	01.xx	For solid state radar
MTR-DRV	0359293	01.xx	
PM	0359296	01.xx	
RF-Converter	0359302	01.xx	For solid state radar
Processor Unit: RPU-025			
MAIN	0359377	50.xx	
SUB	0359380	50.xx	
Control Unit			
KEY	0359385	01.xx	RCU-014/RCU-015/RCU-016
KEY	0359464	01.xx	RCU-031
Power Supply Unit (FAR-2258(-BB)/FAR-2358 only)			
SPU	0359472	01.xx	

xx: Denotes minor changes to the software.

About the programs used in C-type radars

- Ubiquitous QuickBoot Copyright© 2015. Ubiquitous Corp. All right reserved.
- Portions of this software are copyright© 2016. The FreeType Project (www.freetype.org). All right reserved.
- This equipment includes GPL2.0, LGPL2.0, Apache, BSD, MIT or other licensed softwares. For further software information, please access the following URL:
https://www.furuno.co.jp/en/contact/cnt_oss_e01.html

Terminology standards used in this manual

This manual uses the following terminology standards:

Terminology	Meaning or usage example
Select	<ul style="list-style-type: none"> • Use the trackball or scrollwheel on the control unit to move the cursor over the item to be “selected”, then left-click. • With a menu open: Press the appropriate menu number. • With the setting/value/menu selected: Spin the scrollwheel to highlight the item to be “selected”, then left-click
Left-click	Press the left mouse button.
Right-click	Press the right mouse button.
Control Unit	Refers to the RCU-014 Control Unit, unless otherwise specified.
Open the menu.	Press the MENU key to show the [MENU].
Close the menu.	Press the MENU key to close the [MENU].

For the sake of brevity, all procedures in this manual use the terms “Open the menu.” and “Close the menu”.

Unless otherwise stated, operations in this manual use the scrollwheel for procedures which require menu selection, or settings changed.

CE Declaration

With regards to CE declarations, please refer to our website (www.furuno.com) for further information about RoHS conformity declarations.

SYSTEM CONFIGURATION

NOTICE

For IMO-type radars, interconnected sensors must meet the following type approval requirements.
For C-type radars, it is recommended that the interconnected sensors meet these requirements:

- Gyrocompass (or equivalent devices) meeting the requirements of the IMO resolution A.424(XI).
- EPFS meeting the requirements of the IMO resolution MSC.112(73).
- SDME meeting the requirements of IMO resolution MSC.96(72).

The radar may be interconnected via HUB-3000 to other FURUNO processing units having approved LAN ports.

X-band: FAR-2218(-BB)/FAR-2228(-BB)/FAR-2328

Note: The footnotes for *1 to *11 are listed in "Notes" on page xxiii.

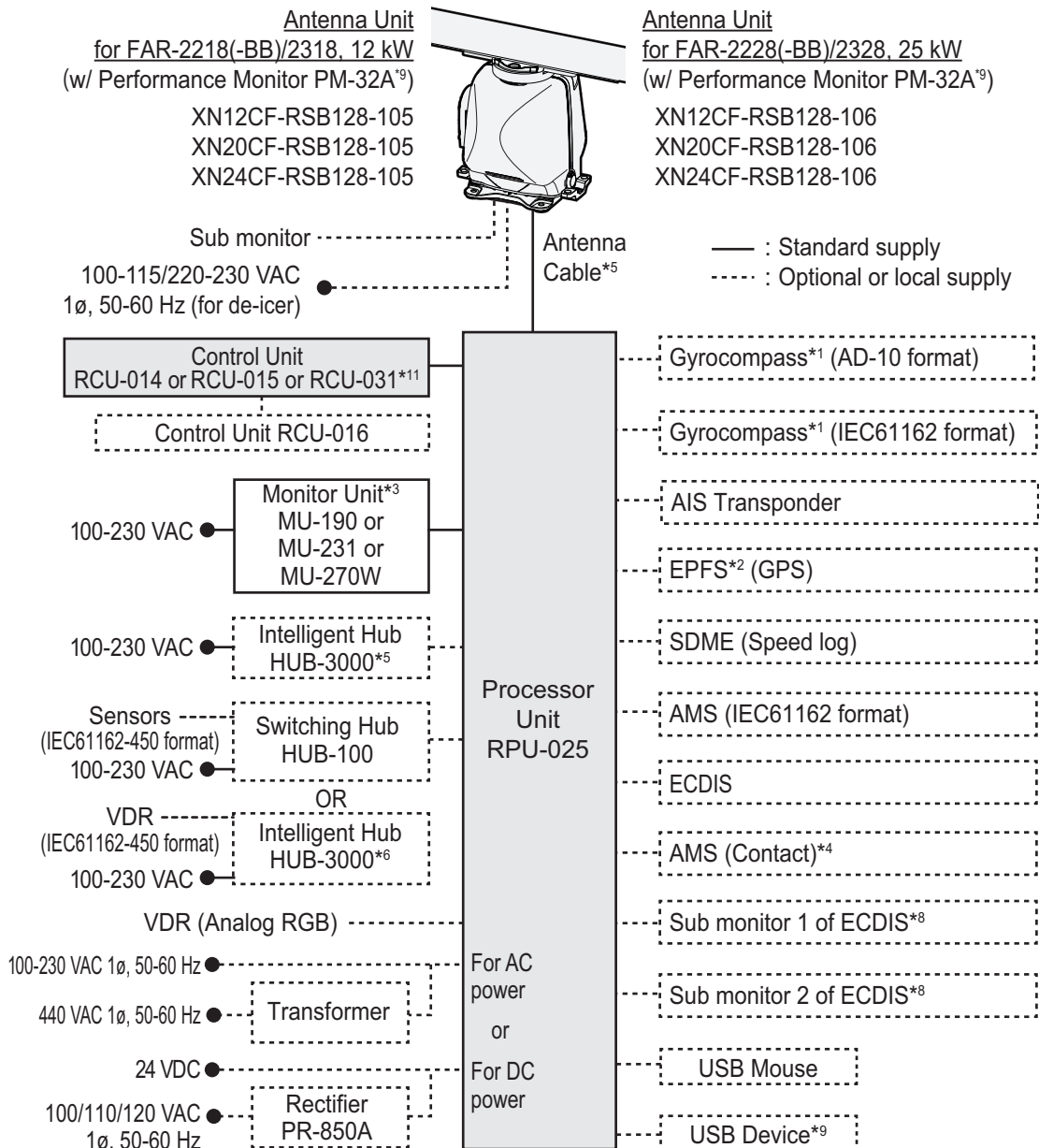

X-band: FAR-2258(-BB)/FAR-2358

Note: The footnotes for *1 to *11 are listed in "Notes" on page xxiii.

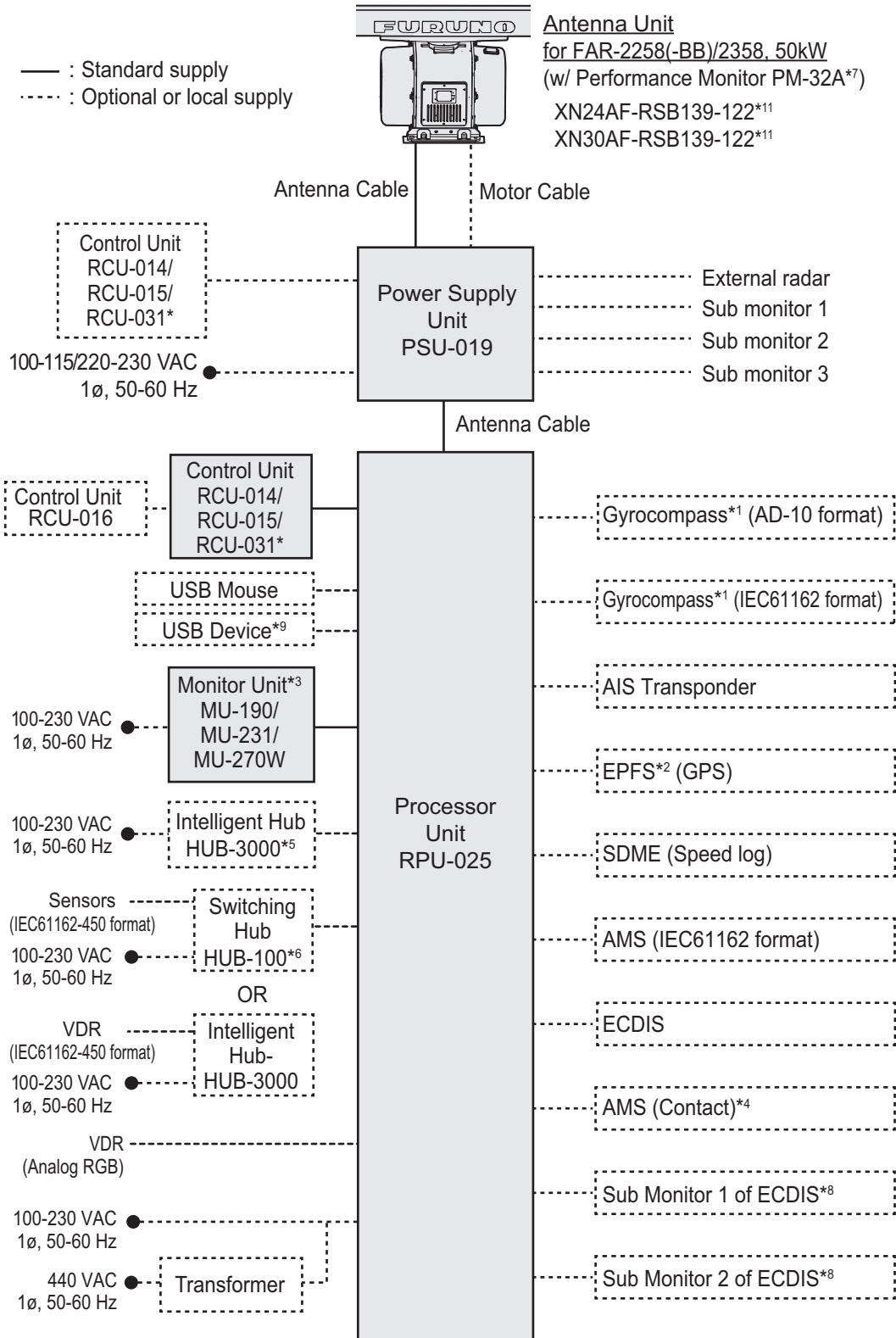

S-band: FAR-2238S(-BB)/FAR-2338S/FAR2238S-NXT(-BB)/ FAR-2338-NXT

Note: The footnotes for *1 to *11 are listed in "Notes" on page xxiii.

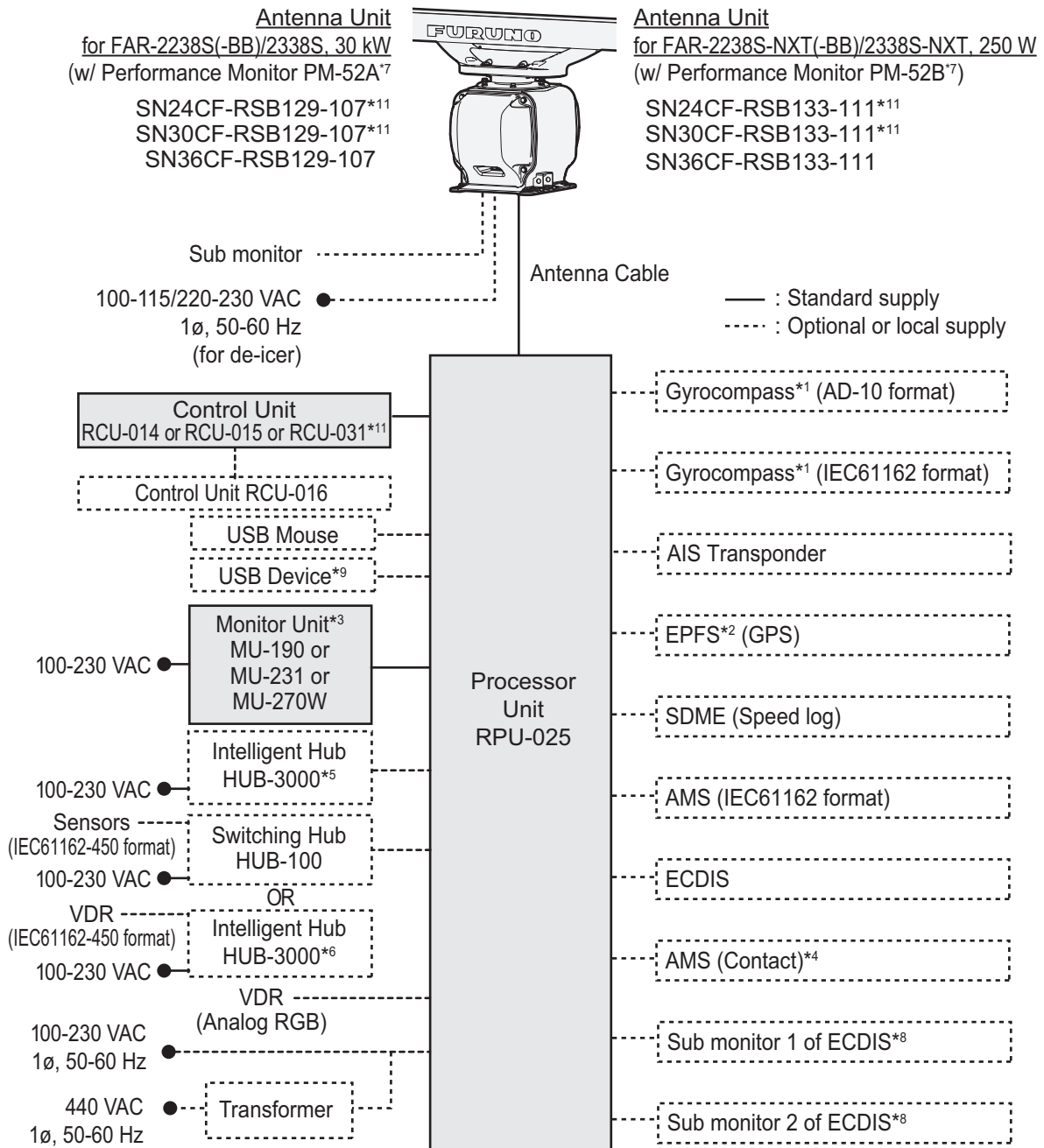

Category of units

Antenna units: Exposed to the weather.

Other units: Protected from the weather.

Notes

- 1) The gyrocompass must be type approved for compliance with IMO resolution A.424(XI) (and/or resolution A.821(19) for installation on HSC). The gyrocompass must also have an update rate that is adequate for the ship's rate of turn. The update rate must be better than 40 Hz (HSC) or 20 Hz (conventional vessel).
- 2) The EPFS must be type approved for compliance with IMO resolution MSC.112(73).
- 3) These monitors have been approved by the IMO, MU-190 for CAT 2 and CAT 2H, MU-231/MU-270W for CAT 1 and CAT 1H. If a different monitor is to be used on IMO vessels, its effective diameter must meet the applicable Category requirements:
 - CAT 1 and CAT 1H: effective diameter 320 mm or higher;
 - CAT 2 and CAT 2H: effective diameter 250 mm or higher.

For installation, operation and viewing distance of other monitor, see its manuals.
For BB type, a monitor unit is prepared by user.
- 4) Characteristics of contact output for Alarm:
 - (Load current) 250 mA;
 - (Polarity) Normally Open: 2 ports, Normally Close: 2 ports;
 - Serial I/O for alarm is also possible, which complies with IEC 61162-1.
- 5) For configurations with 3 or more radars/ECDIS (FMD-3100/FMD-3200/FMD-3300) connected, connect via the HUB-3000. For 2 radars, HUB-100 can be used. (Connection to ECDIS is not available for C-types.)
- 6) For configurations with a VDR connected, connect via the HUB-3000. (Connection to VDR is not available for C-types.)
- 7) Some antenna configurations do not have an in-built Performance Monitor. This type of antenna is not usable for IMO-type radars.
- 8) For connection of non-FURUNO ECDIS only. For connection of radars or plotters, the connection must be done at the radar antenna via the sub monitor connector.
- 9) Available for C-types only.
- 10) For X-Band TR-UP radars only, a junction box is required for antenna cable extension to lengths greater than 100 m. The maximum cable length is 400 m.
- 11) Unavailable on IMO-type radars.

This page is intentionally left blank.

1. OPERATIONAL OVERVIEW

1.1 Controls Overview

Two types of control units are available for your FAR-2xx8: a full keyboard (RCU-014/RCU-031) or palm control (RCU-015/RCU-016).

Most operations can be done with either type of Control Unit. Throughout the manual, procedures are outlined using the RCU-014, unless otherwise specified.

1.1.1 Control Unit RCU-014

You can control almost all aspects of your radar from the RCU-014. The figure and table below show an overview of the control unit with a brief description of the controls.

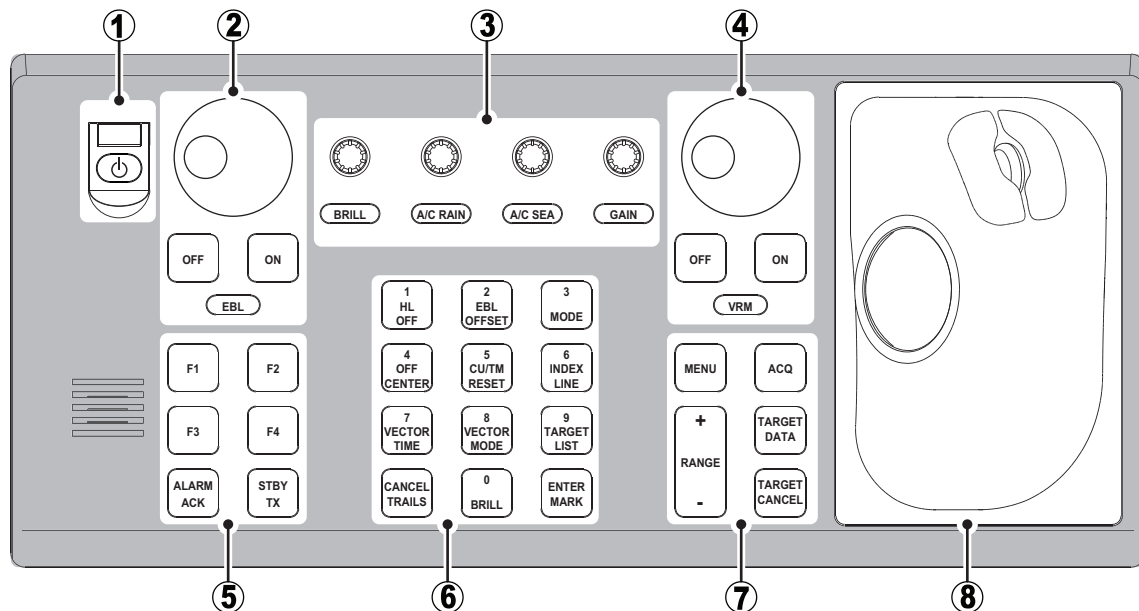

No.	Control Name	Description
1	Power button	Turn the power on or off. See section 1.2.
2	EBL controls	<ul style="list-style-type: none"> • EBL keys: Turn the EBLs on or off. • EBL knob: For IMO-types Move the selected EBL. See section 1.33. For C-types • with the cursor shown: adjust the direction (bearing) of EBLs, PI lines and the diamond cursor; moves the cursor up/downwards. • when entering marks in normal display mode: moves the chart up/downwards.
3	BRILL knob	Adjust echo brilliance and screen brilliance. See section 1.3.
	A/C RAIN knob	Adjust auto/manual clutter reduction for rain. See section 1.21.
	A/C SEA knob	Adjust auto/manual clutter reduction for rough seas. See section 1.20.
	GAIN knob	Adjust the gain (sensitivity). See section 1.19.

1. OPERATIONAL OVERVIEW

No.	Control Name	Description
4	VRM controls	<ul style="list-style-type: none"> • VRM keys: Turn the VRMs on or off. • VRM knob: <u>For IMO-types</u> Move the selected VRM. See section 1.32. <u>For C-types</u> <ul style="list-style-type: none"> • with the cursor shown: adjust the distance (range) of VRMs or PI line intervals; moves the cursor left/rightwards. • when entering marks in normal display mode: moves the chart left/rightwards.
5	Functions keys (F1 to F4)	<ul style="list-style-type: none"> • Perform a pre-registered function. See section 1.8. • with pop up window shown: perform the operation shown in the window.
	ALARM ACK key	Acknowledge active alerts. See section 1.53.
	STBY TX key	Toggle the radar operation between transmit (TX) and standby (STBY). See section 1.15.
6	1, HL OFF key	<ul style="list-style-type: none"> • With the menu open: Select menu item "1". • Press and hold to hide the heading line. Release to re-show the heading line. See section 1.44.1.
	2, EBL OFFSET key	<ul style="list-style-type: none"> • With the menu open: Select menu item "2". • Sets the positive/negative value to "+". See section 1.13 and section 1.9. • Offset or reset the EBL. See section 1.34.
	3, MODE key	<u>For IMO-types</u> <ul style="list-style-type: none"> • With the menu open: Select menu item "3". • Change the orientation mode. See section 1.30. <u>For C-types</u> When the MODE key is set to ORIENTATION: Same operation as IMO-types. When the MODE key is set to CURSOR/DISPLAY: <ul style="list-style-type: none"> • With the menu open: Select menu item 3. • Show/hide the cursor.
	4, OFF CENTER key	<ul style="list-style-type: none"> • With the menu open: Select menu item "4". • With the cursor shown: enable or disable off-center. See section 1.36. • With the cursor hidden (C-types only): move the screen center (OS position).
	5, CU/TM RESET key	<ul style="list-style-type: none"> • With the menu open: Select menu item "5". • Course Up mode: Reset the heading line to 000°. See section 1.30. • True Motion mode: Move Own Ship position 75% of the radius in opposite direction of the current heading. See section 1.30.
	6, INDEX LINE key	<ul style="list-style-type: none"> • With the menu open: Select menu item "6". • Short press: Select a PI line. See section 1.40. • Long press: Show or hide the selected PI line. See section 1.40.
	7, VECTOR TIME key	<ul style="list-style-type: none"> • With the menu open: Select menu item "7". • Change the vector time. See section 3.10.2.
	8, VECTOR MODE key	<ul style="list-style-type: none"> • With the menu open: Select menu item "8". • Sets the positive/negative value to "-". See section 1.13 and section 1.9. • Toggle between true and relative vectors. See section 3.10.
	9, TARGET LIST key	<ul style="list-style-type: none"> • With the menu open: Select menu item "9". • Show or hide the TT/AIS target list. See section 3.9.3.

No.	Control Name	Description
6	CANCEL TRAILS key	Without the menu open (see section 1.37.2): <ul style="list-style-type: none"> • Short press: Change the trail display time. • Long press: Erase displayed trails. With the menu open (see section 1.5): <ul style="list-style-type: none"> • Go back one level in the menu. Closes the menu if the top level is displayed. • Cancel changes made to a menu setting.
	0, BRILL key	<ul style="list-style-type: none"> • With the menu open: Select menu item "0". • Change the color scheme. See section 1.46.
	ENTER MARK key	<u>Inside the Operational Display Area (ODA):</u> Inscribe a mark. See section 1.44 . <u>With the menu open:</u> Confirm changes, open the selected menu. See section 1.5
7	MENU key	Open or close the menu the menu. See section 1.5 . Note: The MENU key will not open/close the menu in the following situations: <ul style="list-style-type: none"> • VRM or EBL is being set. • DROP MARK or MARK is being inscribed. • Alarm Zone (AZ) or TARGET ALARM is being set.
	RANGE controls	Increase or decrease the range. See section 1.31 .
	ACQ key	<ul style="list-style-type: none"> • Manually acquire the cursor-highlighted target for Target Tracking (TT).
	TARGET DATA key	<ul style="list-style-type: none"> • Show the information for the cursor-highlighted target. • Activate a sleeping AIS target. See section 3.2.
	TARGET CANCEL key	<ul style="list-style-type: none"> • Cancel tracking for the selected target. • Sleep the selected AIS target. • Long press: Cancel tracking for all TT targets. See section 3.2. • Delete marks/waypoints*. • Cancel character input*. *: C-type only.
8	Trackball controls	See section 1.1.3 .

1. OPERATIONAL OVERVIEW

1.1.2 Control Unit RCU-031 (C-types only)

The figure and table below show an overview of the control unit with a brief description of the controls.

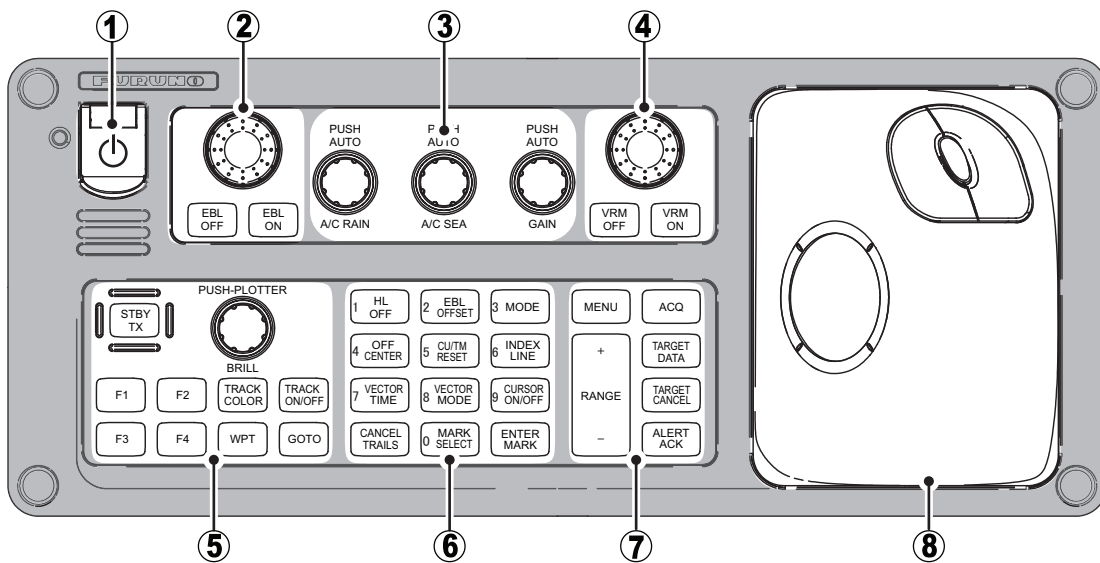

No.	Control Name	Description
1	Power button	Turn the power on or off. See section 1.2.
2	EBL controls	<ul style="list-style-type: none"> • EBL keys: Turn the EBLs on or off. • EBL knob: <ul style="list-style-type: none"> • with the cursor shown: adjust the direction (bearing) of EBLs, PI lines and the diamond cursor; moves the cursor up/downwards. • when entering marks in normal display mode, or in standby: moves the chart up/downwards.
3	A/C RAIN knob	<ul style="list-style-type: none"> • Turn: Adjust auto/manual clutter reduction for rain. See section 1.21. • Press: Toggle the A/C RAIN function on/off.
	A/C SEA knob	<ul style="list-style-type: none"> • Turn: Adjust auto/manual clutter reduction for rough seas. See section 1.20. • Press: Toggle the A/C SEA function on/off.
	GAIN knob	<ul style="list-style-type: none"> • Turn: Adjust the gain (sensitivity). See section 1.19. • Press: Toggle the ACE (Automatic Clutter Elimination) function on/off.
4	VRM controls	<ul style="list-style-type: none"> • VRM keys: Turn the VRMs on or off. • VRM knob: <ul style="list-style-type: none"> • with the cursor shown: adjust the distance (range) of VRMs or PI line intervals; moves the cursor left/rightwards. • when entering marks in normal display mode, or in standby: moves the chart left/rightwards.
5	STBY TX key	Toggle the radar operation between transmit (TX) and standby (STBY). See section 1.15.
	BRILL knob	Adjust echo brilliance and screen brilliance. See section 1.3.
	Functions keys (F1 to F4)	<ul style="list-style-type: none"> • Perform a pre-registered function. See section 1.8. • with pop up window shown: perform the operation shown in the window.
	TRACK COLOR key	Opens the [CHANGE TRACK COLOR] window.
	TRACK ON/OFF key	Starts/stops own ship track recording.

No.	Control Name	Description
5	WPT key	Opens the [WAYPOINT ENTRY] window. (Requires [ROUTE DATA SOURCE] in the [ROUTES•WAYPOINTS] to be set as [INTERNAL DATA].)
	GOTO key	Set/remove a GOTO destination.
6	1, HL OFF key	<ul style="list-style-type: none"> • With the menu open: Select menu item "1". • Press and hold to hide the heading line. Release to re-show the heading line. See section 1.44.1.
	2, EBL OFFSET key	<ul style="list-style-type: none"> • With the menu open: Select menu item "2". • Sets the positive/negative value to "+". See section 1.13 and section 1.9. • Offset or reset the EBL. See section 1.34.
	3, MODE key	<p>When the MODE key is set to ORIENTATION:</p> <ul style="list-style-type: none"> • With the menu open: Select menu item "3". • Change the orientation mode. See section 1.30. <p>When the MODE key is set to CURSOR/DISPLAY:</p> <ul style="list-style-type: none"> • With the menu open: Select menu item 3. • Show/hide the cursor.
	4, OFF CENTER key	<ul style="list-style-type: none"> • With the menu open: Select menu item "4". • With the cursor shown: enable or disable off-center. See section 1.36. • With the cursor hidden: move the screen center (OS position).
	5, CU/TM RESET key	<ul style="list-style-type: none"> • With the menu open: Select menu item "5". • Course Up mode: Reset the heading line to 000°. See section 1.30. • True Motion mode: Move Own Ship position 75% of the radius in opposite direction of the current heading. See section 1.30.
	6, INDEX LINE key	<ul style="list-style-type: none"> • With the menu open: Select menu item "6". • Short press: Select a PI line. See section 1.40. • Long press: Show or hide the selected PI line. See section 1.40.
	7, VECTOR TIME key	<ul style="list-style-type: none"> • With the menu open: Select menu item "7". • Change the vector time. See section 3.10.2.
	8, VECTOR MODE key	<ul style="list-style-type: none"> • With the menu open: Select menu item "8". • Sets the positive/negative value to "-". See section 1.13 and section 1.9. • Toggle between true and relative vectors. See section 3.10.
	9, TARGET LIST key	<ul style="list-style-type: none"> • With the menu open: Select menu item "9". • Show or hide the TT/AIS target list. See section 3.9.3.
	CANCEL TRAILS key	<p>Without the menu open (see section 1.37.2):</p> <ul style="list-style-type: none"> • Short press: Change the trail display time. • Long press: Erase displayed trails. <p>With the menu open (see section 1.5):</p> <ul style="list-style-type: none"> • Go back one level in the menu. Closes the menu if the top level is displayed. • Cancel changes made to a menu setting.
	0, BRILL key	<ul style="list-style-type: none"> • With the menu open: Select menu item "0". • Change the color scheme. See section 1.46.
ENTER MARK key	<p><u>Inside the Operational Display Area (ODA):</u> Inscribe a mark. See section 1.44.</p> <p><u>With the menu open:</u> Confirm changes, open the selected menu. See section 1.5</p>	

1. OPERATIONAL OVERVIEW

No.	Control Name	Description
7	MENU key	Open or close the menu the menu. See section 1.5. Note: The MENU key will not open/close the menu in the following situations: <ul style="list-style-type: none"> • VRM or EBL is being set. • DROP MARK or MARK is being inscribed. • Alarm Zone (AZ) or TARGET ALARM is being set.
	RANGE controls	Increase or decrease the range. See section 1.31.
	ACQ key	<ul style="list-style-type: none"> • Manually acquire the cursor-highlighted target for Target Tracking (TT).
	TARGET DATA key	<ul style="list-style-type: none"> • Show the information for the cursor-highlighted target. • Activate a sleeping AIS target. See section 3.2.
	TARGET CANCEL key	<ul style="list-style-type: none"> • Cancel tracking for the selected target. • Sleep the selected AIS target. • Long press: Cancel tracking for all TT targets. See section 3.2. • Delete marks/waypoints. • Cancel character input.
	ALARM ACK key	Acknowledge active alerts. See section 1.53.
8	Trackball controls	See section 1.1.3.

1.1.3 Control Unit RCU-015/RCU-016

The RCU-015 and RCU-016 offer an easy to use mouse-like control interface, without the bulkiness of the RCU-014. You can access all your radar functions from the RCU-015/RCU-016, however, only the function keys are available as short-cut keys.

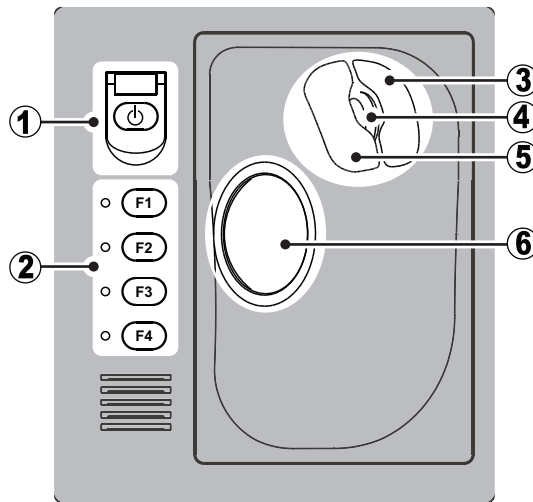

No.	Control Name	Description
1	Power button*	Turn the power on or off. See section 1.2.
2	Functions keys (F1 to F4)	Perform a pre-registered function. See section 1.8.
3	Right mouse button	<u>Short press:</u> <ul style="list-style-type: none"> Show the pop up menu for the highlighted item. Cancel changes to the currently selected setting. With TT target or mark symbol highlighted: Open the editing window (C-types only). With pop up menus shown: Hide pop up menus. <u>Long press:</u> <ul style="list-style-type: none"> Change the screen brilliance to [50].
4	Scrollwheel	<ul style="list-style-type: none"> Change settings. Highlight a menu item. With TT target selected: Change the TT target's symbol (C-types only).
5	Left mouse button	Select a highlighted object or menu item.
6	Trackball	<u>For IMO-types</u> <ul style="list-style-type: none"> Moves the cursor. Highlight an object or menu item. <u>For C-types</u> <ul style="list-style-type: none"> Moves the cursor (when the cursor is shown). Moves the chart (when the cursor is hidden). Highlight an object or menu item.
*: The RCU-016 Control Unit has no power button. To turn the power on or off when using a RCU-016 Control Unit, use the power button on the RCU-014/RCU-015/RCU-031 Control Unit.		

About the terminology used in this manual

Unless otherwise started, the terms “click” and “left-click” mean “use the trackball to place the cursor on the specified item, then press the left mouse button”. The term “right-click” means “use the trackball to place the cursor on the specified item, then press the right mouse button”.

1.2 How to Turn the Radar On/Off

The power button (⏻) is located at the top-left corner of the RCU-014, RCU-015 and RCU-031 Control Units.

To turn the power on, open the power switch cover, then press the power button.

The LED to the left of the power button lights up (green color) and the system begins the startup process. The indication "Initializing....." appears at the center of the screen.

C-types also display two messages regarding charts, after the startup process is complete.



When the startup process is complete, the system begins warm-up procedures to prepare the magnetron for transmission. The warm-up can take up to three minutes.

During the warm-up, indications for total on-time (magnetron on-time since installation) and total transmission time (since installation) appear below the warm-up countdown timer. These indications are also displayed when the radar is in standby mode.

When the warm-up process is complete, the radar goes into standby (STBY) mode and the indication "RADAR STBY" (IMO-types) or "STBY" (C-types) appears. This indication also appears whenever the equipment is in STBY mode.

Note 1: For C-types, the "STBY" indication appears only once, when the equipment is turned on. Further, the numerals on the heading dial (outer-most range ring) are not shown and the AIS function is active, however the TT function is inactive while in standby (STBY) mode.

Note 2: Do not turn on the power directly after it has been turned off. Wait several seconds before you reapply the power, to be sure the radar starts up properly.

Note 3: The RCU-016 Control Unit has no power button. To turn the power on or off when using a RCU-016 Control Unit, use the power button on the RCU-014/RCU-015/RCU-031 Control Unit.

Note 4: Solid state radars do not have a magnetron, therefore they have no warming period.

To turn the power off, open the power switch cover, then press the power button.

1.3 How to Adjust the Brilliance

The screen brilliance (brightness) for monitors can be adjusted as shown below.

Note: The following procedure applies only to monitors supplied by FURUNO for this system. For other monitors, see the monitor operator's manual to adjust the brilliance.

Brilliance adjustment from the Control Unit (RCU-014/RCU-031)

Rotate the **BRILL** knob clockwise to increase the brilliance (brighter), or rotate the **BRILL** knob counter-clockwise to reduce the brilliance (darker).

Brilliance adjustment from the on-screen box

Select the brilliance indication in the lower half of the [BRILL] box, then spin the scrollwheel on the Control Unit upwards to reduce the brilliance (darker) or downwards to increase the brilliance (brighter).

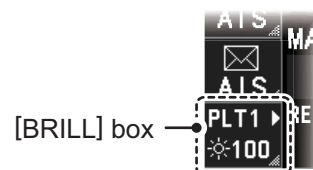

Note: The above scrollwheel operation is based on default settings for [2 MOUSE WHEEL DIR]. See section 1.9.

1.4 Display Overview

1.4.1 Display examples

C-type radars have two display formats, [NORMAL] and [SIMPLE]. IMO-types have one standard display format. The information shown on-screen changes depending on the radar type and the display format selected.

You can change the display format for C-types from [6 DISPLAY MODE] (located in [9 INITIAL SETTINGS] → [5 OPERATION] menu; see section 1.9).

Note 1: The example screen below may differ slightly from your display, depending on the monitor used in your configuration. The overall information however, is the same.

Note 2: Unless otherwise indicated, the example figures for C-type radars used in this manual are taken using the [NORMAL] display.

Display specifications

	MU-190	MU-231	MU-270W
Nominal viewing distance	1.02 m	1.20 m	1.02 m
Text height (min. font)	3.53 mm	4.23 mm	3.64 mm
Text width (min. font)	2.36 mm	2.97 mm	2.43 mm

1. OPERATIONAL OVERVIEW

Standard display

- IMO-type standard display

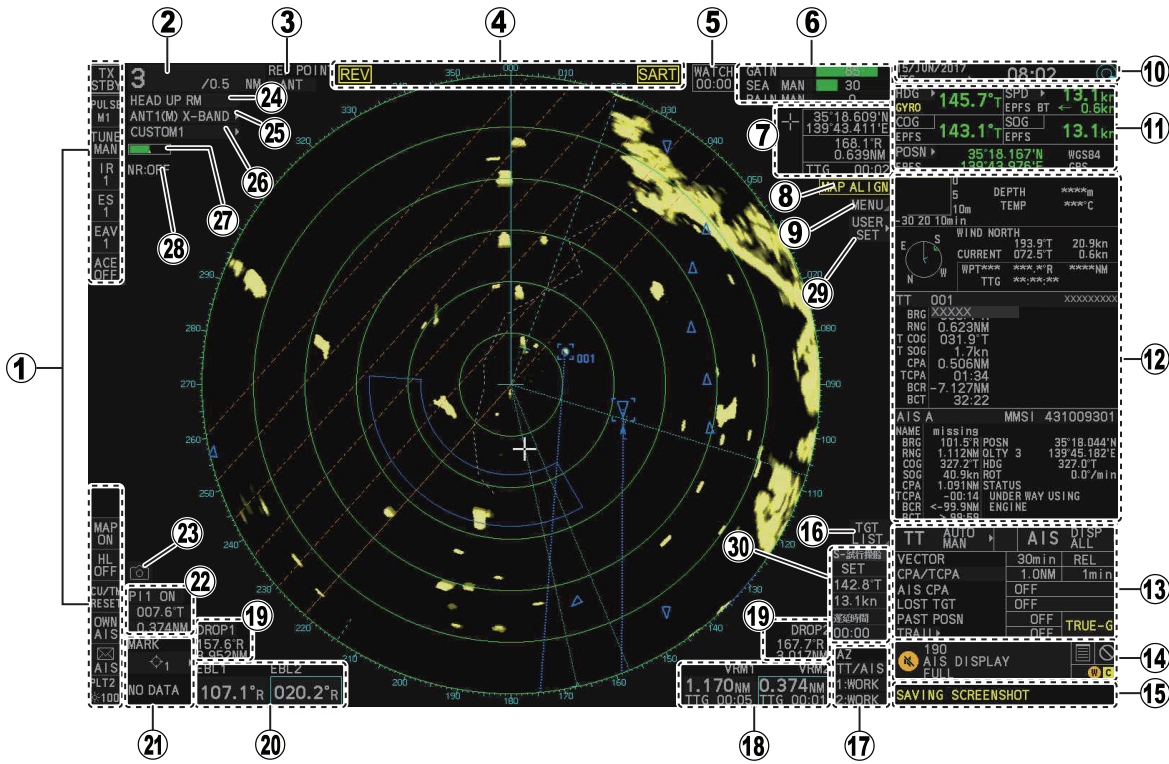

- C-type standard display

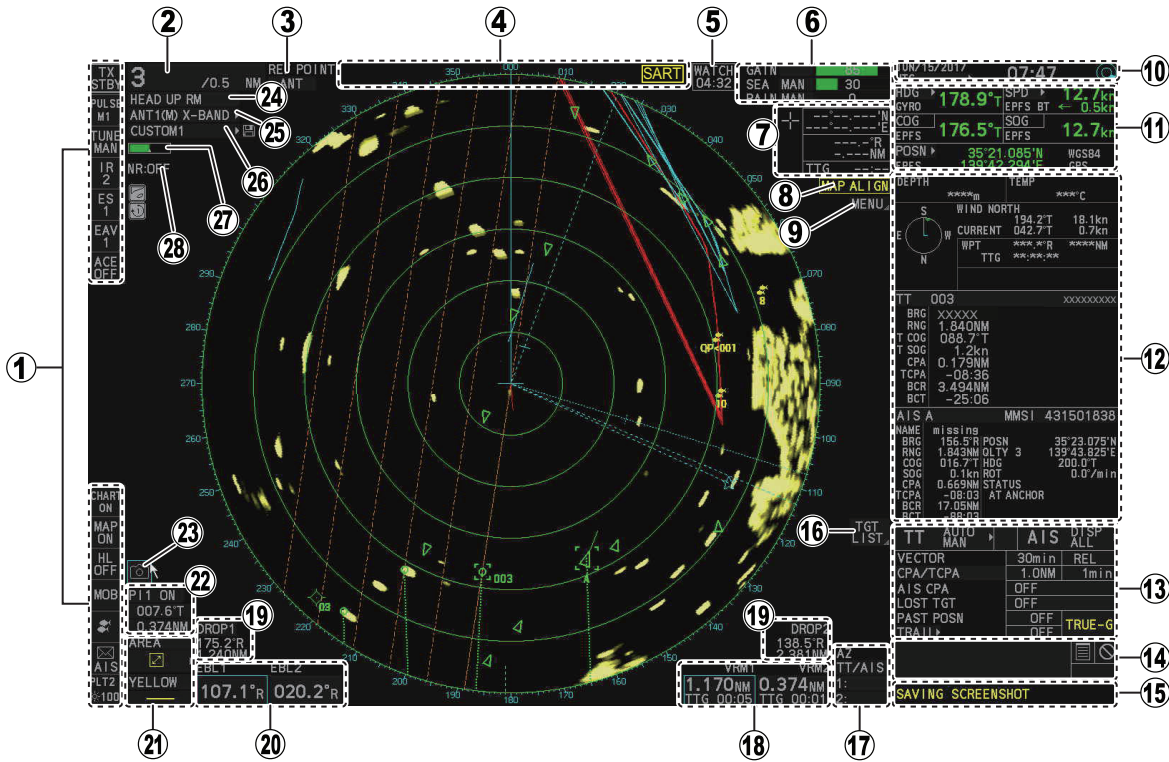

No.	Name	Description
1	InstantAccess bar™	Contains functions and features which are used regularly and allows easy access/activation. For descriptions of each button on the bar, see section 1.4.2
2	[RANGE] box	Shows/changes the current range in use.
3	[REF POINT] box	Shows/changes the point of reference.
4	Indications	Shows indications for SART, shuttle ferry mode (IMO-type only) etc.
5	[WATCH] box	<ul style="list-style-type: none"> Shows the watch alert countdown timer. Resets the watch alert countdown.
6	[ECHO ADJUST] box	Place the cursor on a box to adjust the setting. <ul style="list-style-type: none"> [GAIN] bar: Shows the level of gain in use. [SEA] bar: Shows the level and mode of sea clutter reduction. [RAIN] bar: Shows the level and mode of rain clutter reduction.
7	Cursor position details	Shows the location (coordinates) of the cursor with the estimated TTG to the cursor position.
8	[MAP ALIGN] indication	Shows/hides the map alignment status.
9	[MENU] box	Opens/closes the menu.
10	Date/Time	<ul style="list-style-type: none"> Shows date and time (with offset indication). Working indication (blue circle) indicates that the system is working correctly. Stops rotating when the system is frozen or malfunctioning.
11	Own Ship information	Shows heading, speed, water tracking speed* ¹ , COG, SOG* ² , coordinates and sensor used for data input. * ¹ : Drift speed and direction (port/starboard) is indicated with arrows and numerals. * ² : When connected with a speed log, the indication changes to read "SLOG".
12	Information box	<ul style="list-style-type: none"> Shows information for selected TT or AIS targets. Shows the currently selected menu. Shows navigational data. Shows the performance monitor graph. Shows the zoomed area.
13	TT/AIS settings	<ul style="list-style-type: none"> Adjust TT/AIS vector settings. Adjust CPA/TCPA settings. Activate/sleep AIS targets. Adjust lost target alert settings. Adjust track plotting intervals. Adjust trail times.
14	Alert box	Shows active alerts and contains the buzzer silence button and a shortcut to the alert list.
15	Guidance box	Shows operational guidance for the Control Unit's left button and right button .
16	[TGT LIST] box	Shows the target details list for tracked TTs and active AIS targets.
17	[ACQUISITION ZONE] box	<ul style="list-style-type: none"> Adjust acquisition zone settings for target alarms. Toggle between sentry zone and acquisition zone alert modes.
18	[VRM] box	<ul style="list-style-type: none"> Activate/deactivate the VRM (Variable Range Marker). Adjust the active (selected) VRM. Shows VRM range and TTG.
19	[DROP MARK] box	Shows the bearing and range to the drop mark(s).

1. OPERATIONAL OVERVIEW

No.	Name	Description
20	[EBL] box	<ul style="list-style-type: none"> • Activate/deactivate the EBL (Electronic Bearing Line). • Adjust the active (selected) EBL. • Shows EBL bearing.
21	[MARK] box	<ul style="list-style-type: none"> • Selects a map mark to use. • Inscribes the selected map mark. • Right-click: opens the [RADAR MAP] menu (IMO-types); opens the [MARK] menu (C-types).
22	[PI Lines] box	<ul style="list-style-type: none"> • Selects PI line set to use. • Shows/hides the selected PI lines. • Shows the angle, reference and range interval for the PI lines.
23	Screenshot button	Saves a screenshot of the entire displayed area. Note: Requires SD card to be inserted in the Processor Unit. Shown in gray and not selectable if no SD card is inserted.
24	[PRESENTATION MODE] box	Change the presentation (orientation) mode for the radar images.
25	[ANTENNA SELECTION] box	Selects the antenna to use for radar images.
26	[PICTURE] box	Customize the way in which echoes are displayed.
27	[NOISE REJECTOR] indication	Shows the noise rejector function's ON/OFF status.
28	[TUNING LEVEL] bar	<ul style="list-style-type: none"> • Shows the level of tuning in use. See section 1.16. • Adjusts the tuning (manual only). See section 1.16.3. <p>Note 1: The [TUNING LEVEL] bar is not shown for solid state radars.</p> <p>Note 2: The [TUNING LEVEL] bar is not shown on FAR-2x58 monitors which are assigned as [SUB] at installation.</p>
29	User settings box*	<ul style="list-style-type: none"> • Loads pilot settings. • Opens the [USER SET] menu.
30	[TRIAL MANEUVERS] box*	<ul style="list-style-type: none"> • Activates/deactivates trial maneuvers. • Sets up trial maneuver parameters.

*: Shown only for IMO-types.

Simple display (C-types only)

Note: TT/AIS settings are not available in the simple display. To change or adjust TT/AIS settings, make the changes/adjustments at the standard display, then switch to the simple display.

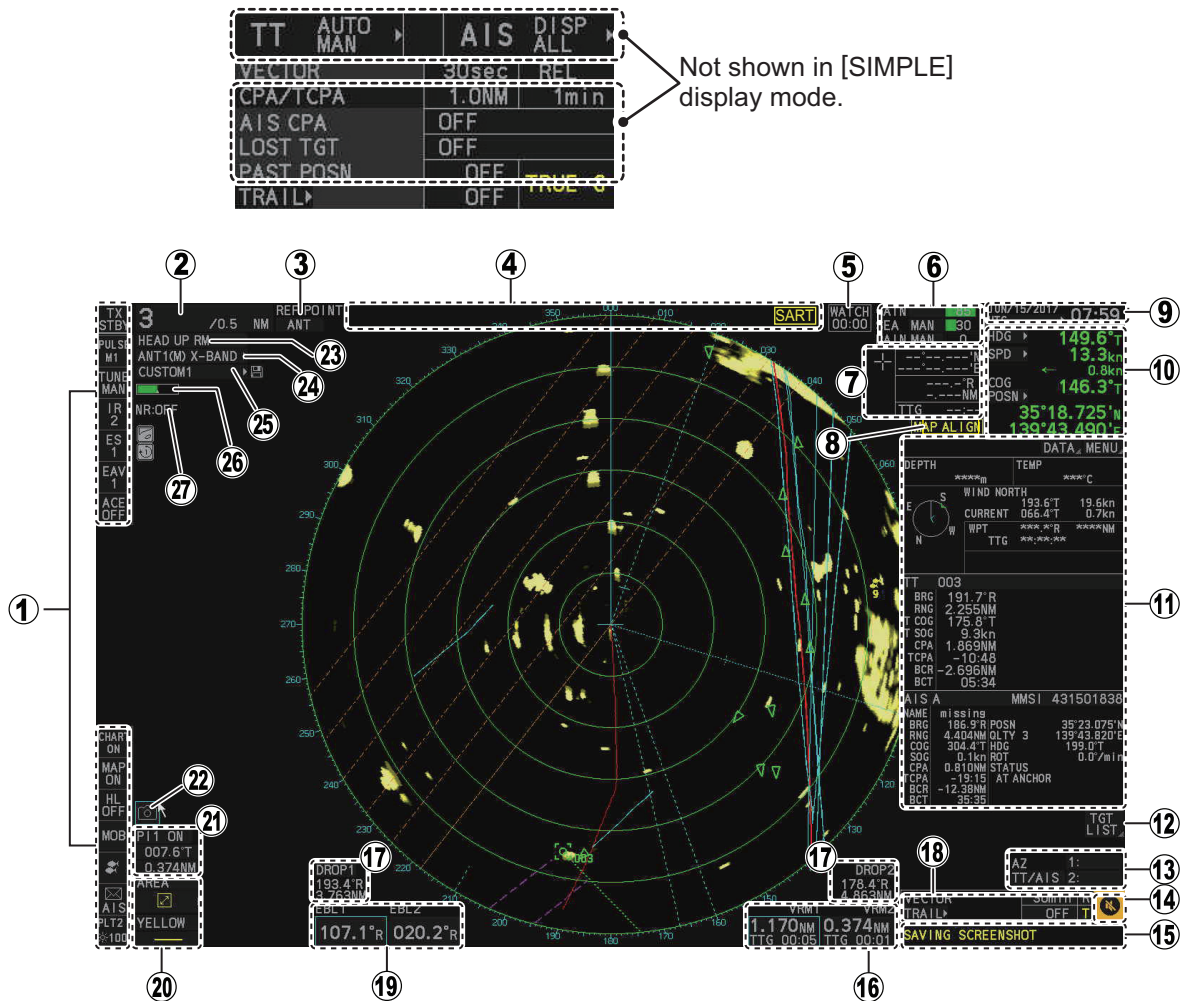

No.	Name	Description
1	InstantAccess bar™	Contains functions and features which are used regularly and allows easy access/activation. For descriptions of each button on the bar, see section 1.4.2
2	[RANGE] box	Shows/changes the current range in use.
3	[REF POINT] box	Shows/changes the point of reference.
4	Indications	Shows indications for SART, etc.
5	[WATCH] box	<ul style="list-style-type: none"> Shows the watch alert countdown timer. Resets the watch alert countdown.
6	[ECHO ADJUST] box	Place the cursor on a box to adjust the setting. <ul style="list-style-type: none"> [GAIN] bar: Shows the level of gain in use. [SEA] bar: Shows the level and mode of sea clutter reduction. [RAIN] bar: Shows the level and mode of rain clutter reduction.
7	Cursor position details	Shows the location (coordinates) of the cursor with the estimated TTG to the cursor position.
8	[MAP ALIGN] indication	Shows/hides the map alignment status.
9	Date/Time	Shows date and time (with offset indication).

1. OPERATIONAL OVERVIEW

No.	Name	Description
10	Own Ship information	Shows heading, speed, water tracking speed* ¹ , COG, SOG* ² , coordinates and sensor used for data input. * ¹ : Drift speed and direction (port/starboard) is indicated with arrows and numerals. * ² : When connected with a speed log, the indication changes to read "SLOG".
11	Information box	<ul style="list-style-type: none"> Click [MENU] to show the menu. Click [DATA] to show the data box; the following information can be displayed. <ul style="list-style-type: none"> Shows information for selected TT or AIS targets. Shows navigational data. Shows the performance monitor graph.
12	[TGT LIST] box	Shows the target details list for tracked TTs and active AIS targets.
13	[ACQUISITION ZONE] box	<ul style="list-style-type: none"> Adjust acquisition zone settings for target alarms. Toggle between sentry zone and acquisition zone alert modes.
14	Alert box	Shows active alerts and contains the buzzer silence button and a shortcut to the alert list.
15	Guidance box	Shows operational guidance for the Control Unit's left button and right button .
16	[VRM] box	<ul style="list-style-type: none"> Activate/deactivate the VRM (Variable Range Marker). Adjust the active (selected) VRM. Shows VRM range and TTG.
17	[DROP MARK] box	Shows the bearing and range to the drop mark(s).
18	Vector/Trail box	<ul style="list-style-type: none"> Set vector/trail times for TT/AIS targets. Switch between true/relative trails and vectors.
19	[EBL] box	<ul style="list-style-type: none"> Activate/deactivate the EBL (Electronic Bearing Line). Adjust the active (selected) EBL. Shows EBL bearing.
20	[MARK] box	<ul style="list-style-type: none"> Selects a map mark to use. Inscribes the selected map mark. Right-click: opens the [MARK] menu.
21	[PI Lines] box	<ul style="list-style-type: none"> Selects PI line set to use. Shows/hides the selected PI lines. Shows the angle, reference and range interval for the PI lines.
22	Screenshot button	Saves a screenshot of the entire displayed area. Note: Requires SD card to be inserted in the Processor Unit. Shown in gray and not selectable if no SD card is inserted.
23	[PRESENTATION MODE] box	Change the presentation (orientation) mode for the radar images.
24	[ANTENNA SELECTION] box	Selects the antenna to use for radar images.
25	[PICTURE] box	Customize the way in which echoes are displayed.
26	[NOISE REJECTOR] indication	Shows the noise rejector function's ON/OFF status.
27	[TUNING LEVEL] bar	<ul style="list-style-type: none"> Shows the level of tuning in use. See section 1.16. Adjusts the tuning (manual only). See section 1.16.3. Note 1: The [TUNING LEVEL] bar is not shown for solid state radars. Note 2: The [TUNING LEVEL] bar is not shown on FAR-2x58 monitors which are assigned as [SUB] at installation.





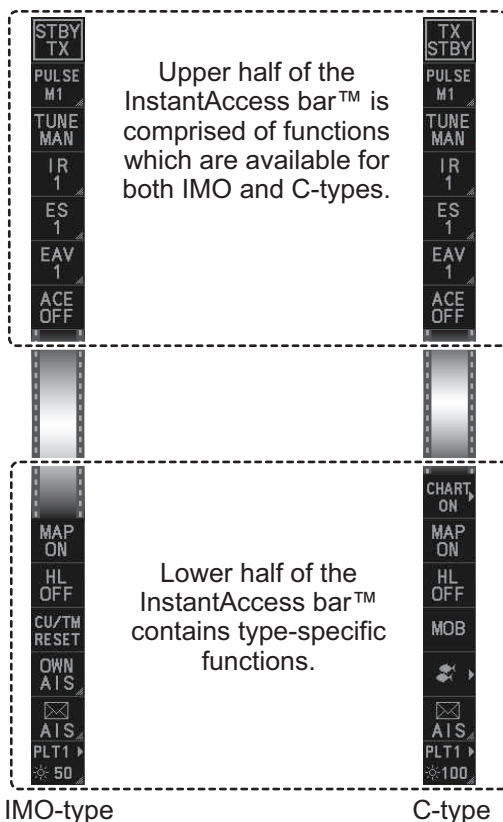









1.4.2 InstantAccess bar™

The InstantAccess bar™ contains functions and features which are used regularly and allows easy access/activation. For descriptions of each button on the bar, see the table in this section.



Button	Description
Upper Half - Common functions/features for both IMO and C-types	
	[Standby/Transmit] button. Toggle between standby (STBY) and transmit (TX).
	[Pulselength] button. Selects the pulselength. Note: The [Pulselength] button is not shown on FAR-2x58 monitors which are assigned as [SUB] at installation; instead the button is replaced with the indication "SUB".
	[Tune] button. Toggles between automatic and manual tuning. (See section 1.16.1.) Note 1: For SSD antennas, this button appears as "TX CH x" ("x" denotes the channel used for transmission). If your radar is receiving interference from another radar operating at the same frequency, use the [TX CH] button to change the TX frequency. Note 2: The [Tune] button is grayed out and inoperable on FAR-2x58 monitors which are assigned as [SUB] at installation.
	[Interference Rejector] button. Activates/deactivates the interference rejector feature.
	Echo Stretch button. Activates/deactivates the echo stretch function. Note: This item is grayed out under the following conditions: <ul style="list-style-type: none"> • ACE function is active. • No position data is input (excludes Dead Reckoning).

1. OPERATIONAL OVERVIEW

Button	Description
	[Echo Average] button. Activates/deactivates the echo average function.
	[ACE] button. Activates/deactivates the ACE (Auto Clutter Elimination) function.
Lower Half - IMO-types	
	[Radar Map] button. Shows/hides the radar map marks.
	[HEADING LINE] button. Left-click and hold to hide the heading line.
	[CU/TM RESET] button <ul style="list-style-type: none"> • Puts the ship's heading at the top of the screen in course-up mode the moment this button is pressed. • Resets the ship's position to a point of 75% radius opposite to the extension of the heading line passing through the display center in true motion modes.
	[Own Ship AIS] button. Shows the AIS VOYAGE DATA for AIS data setup.
	[AIS Message] button. <ul style="list-style-type: none"> • Displays received AIS messages. • Opens the [AIS Message] menu.
	[Brilliance] button. <ul style="list-style-type: none"> • Adjusts the screen brilliance • Opens the [BRILLIANCE] menu. • Selects the color palette. See section 1.46.3.
Lower Half - C-types (Standard and Simple display modes)	
	[Chart] button. <ul style="list-style-type: none"> • Shows/hides the chart. • Opens the [CHART] menu.
	[Radar Map] button. Shows/hides the radar map marks.
	[HEADING LINE] button. Left-click and hold to hide the heading line.
	[MOB] button Inserts an MOB mark at the current OS location.
	[WPT MARK] button. (Icon shown to the left changes depending on your selection.) <ul style="list-style-type: none"> • Left-click/Spin the scrollwheel to select a waypoint (WPT) mark icon to use. • Right-click to show the [ROUTES•WAYPOINTS] menu.
	[AIS Message] button. <ul style="list-style-type: none"> • Displays received AIS messages. • Opens the [AIS Message] menu.
	[Brilliance] button. <ul style="list-style-type: none"> • Adjusts the screen brilliance • Opens the [BRILLIANCE] menu. • Selects the color palette. See section 1.46.3.

1.5 Menu Operations

1.5.1 How to open and close the main menu

The main menu can be accessed from the control unit or from the on-screen box. The [MAIN MENU] appears in the information box at the right side of the screen.

From the control unit (RCU-014/RCU-031)

Press the **MENU** key on the control panel.

From the on-screen box

Select the [MENU] box, then press the **left button**.

MAIN MENU	
1	ECHO
2	MARKS
3	NAV TOOLS
4	ALERTS
5	TT·AIS
6	FILES
7	INFORMATION BOX
8	NAV LINE·WPT
9	INITIAL SETTINGS

IMO-types' Main Menu

MAIN MENU	
1	ECHO
2	MARKS·PLOTTER
3	CURSOR·EBL·VRM
4	ALERTS
5	TT·AIS
6	FILES
7	INFORMATION BOX
8	ROUTES·WAYPOINTS
9	INITIAL SETTINGS

C-types' Main Menu

Note 1: For the sake of abbreviation in procedures, the above methods are written collectively as “Open the menu.” and “Close the menu.”

Note 2: Unless otherwise stated, this manual uses display and menu examples from the C-type.

1.5.2 How to operate the menus

1. Open the menu.
2. Roll the scrollwheel to select a menu item, then left-click. The menu item currently selected is highlighted and shown in reverse video. You can also select a menu item by pressing the corresponding numeric key on the control unit.

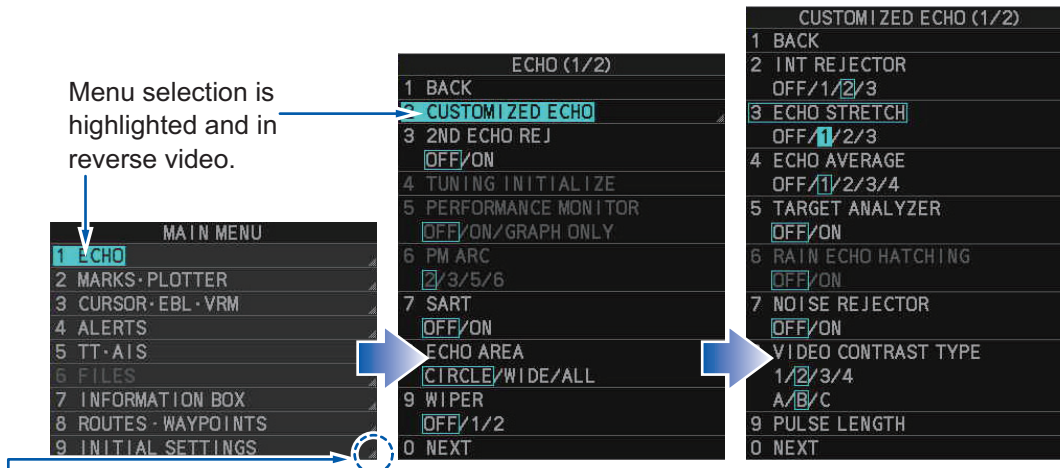

Select menu items with arrows (↵) to access the next menu layer.

In this example, the [ECHO] menu is accessed, then the [CUSTOMIZED ECHO] menu is accessed.

The next menu layer appears. Menu items with arrows, as shown in the above example figure, have their own menu layer. You can select these items to show the respective menu.

3. Roll the scrollwheel to select a menu item, then left-click. You can also select a menu item by pressing the corresponding numeric key.

When required, repeat this step to access the next menu.

In the example, [1 ECHO] is selected, which opens the [ECHO (1/2)] menu. Next, [2 CUSTOMIZED ECHO] is selected, which opens the [CUSTOMIZED ECHO (1/2)] menu. Finally, [3 ECHO STRETCH] is selected, in order to change settings. Menus such as the [ECHO] menu and [CUSTOMIZED ECHO] menu have more than one page. In this case, the currently displayed page is indicated in brackets to the right of the menu title.

To view the next page of a menu, select [0 NEXT].

To go back one layer (or page) in the menu, left-click [1 BACK], or right-click.

4. Roll the scrollwheel to select the desired setting, then left-click. The selected setting is highlighted and displayed in reverse video.

In the above example, the selected setting at [3 ECHO STRETCH] is [1].

5. Close the menu.

Note 1: Unless otherwise stated, operations in this manual use the scrollwheel for procedures which require menu selection, or settings changed.

Note 2: The term “Select” has the following meanings in this manual:

- Use the trackball to place the cursor on the indicated item, then left-click.
- Roll the scrollwheel to select the indicated menu option/setting.

1.5.3 Alphanumeric input

When alphanumeric input is required, the software keyboard (shown in the figure below) or the alphanumeric input window (C-types only) appears.

Operating the software keyboard

Select the number/character desired with the cursor, then left-click. When you finish entering the desired numbers/characters, left-click the [END] button on the software keyboard.

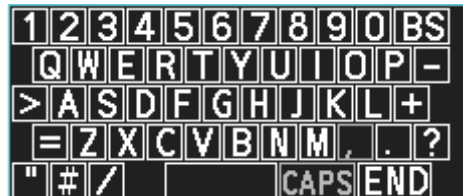

Alphanumeric input window

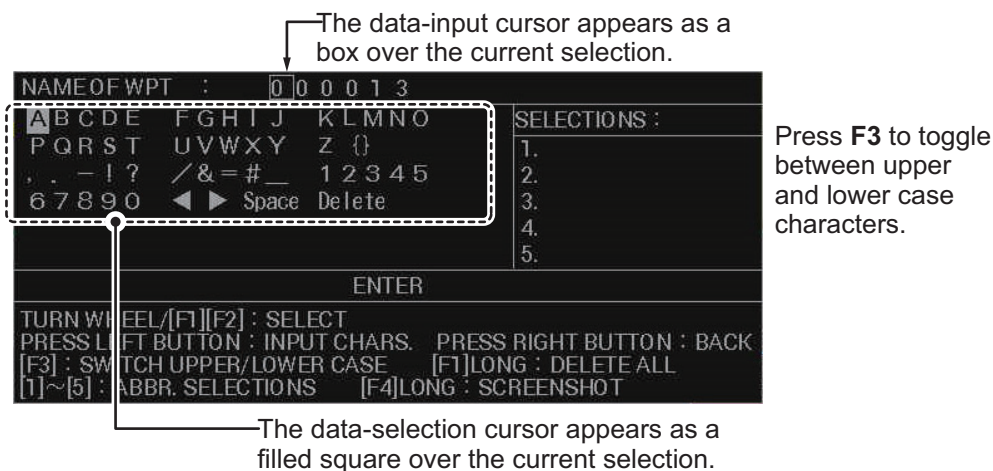

- Using the trackball or the scrollwheel, select the character/numeral you want to input, then left-click. The selected character/numeral appears at the location of the data-input cursor, then the data-input cursor moves to the next character/numeral.
- Repeat step 1 as required.
 - To move the data-input cursor, select [**<**] or [**>**] as required.
 - To delete a character/numeral, move the data-input cursor to the character/numeral that you want to delete, then left-click [**Delete**].
 - To clear the input area of all characters/numerals, press and hold **F1**.
- Select [**ENTER**] to complete alphanumeric input and close the window.



Note: You can store up to five “input shortcuts”. These shortcuts appear in the [SELECTIONS] column of the window. To create/edit a shortcut, press the appropriate key, as listed below.

- [SELECTION 1]: **1 HL OFF**
- [SELECTION 2]: **2 EBL OFFSET**
- [SELECTION 3]: **3 MODE**
- [SELECTION 4]: **4 OFF CENTER**
- [SELECTION 5]: **5 CU/TM RESET**

If no shortcuts are registered by the user, the system stores the 5 most frequently used items to each of the shortcuts.

1.6 How to Use the On-screen Box Menus

Some radar functions can be accessed using the on-screen box as a shortcut to the respective menus. A "▶" at the right side of an on-screen box indicates that there is a menu shortcut available.

Note: The cursor changes shape according to its location. When placed outside the operational display area the cursor is an arrow () shape. When placed inside the operational display area, it is a cross ().

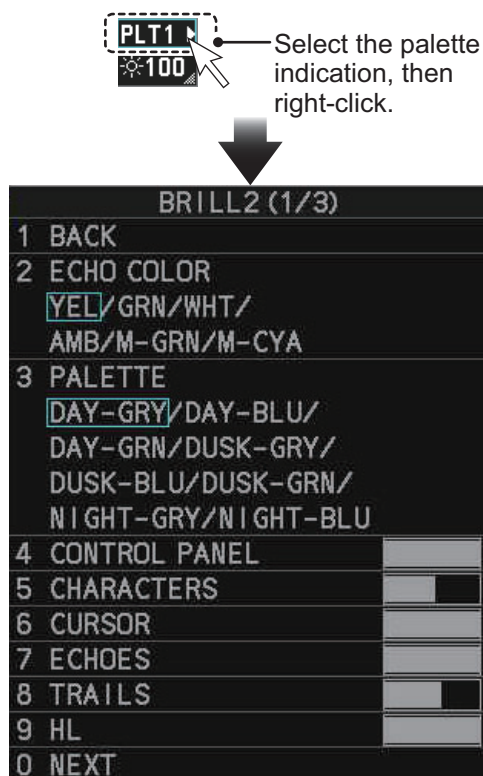

For the purpose of this example, place the cursor on the palette indication (displayed as "PLTx", where x is the currently selected palette number), inside the brilliance settings box at the bottom-left of the screen.

The selected item appears highlighted with a light-blue colored box.

Right-click to show the brilliance menu.

Shortcuts are available from the following on-screen boxes/indications/buttons:

- [PICTURE] box.
- [AIS] box.*
- [TT] box.*
- [HDG] indication.
- [SPD] indication.
- [POSN] indication.
- [PLT] indication.
- [ANTENNA SELECTION] box.
- User settings box.**
- [MARK] box.
- Time indication ("UTC" or "Local").
- [TRAIL] indication.
- [CHART] button.***
- [WPT MARK] button.***

*: Not shown on C-type simple display.

**: Shown only on IMO-types.

***: Shown only on C-types.

1.7 [CURSOR] Menu and Cursor Operations

1.7.1 How to show/hide the cursor (C-type only)

You can show/hide the cursor with one of the following methods:

- Press the **9 CURSOR ON/OFF** key.
- Press the **3 MODE** key. This method requires [5 MODE KEY FUNCTION] set to [CURSOR ON-OFF] (located in [9 INITIAL SETTINGS] → page 2 of [5 OPERATIONS] menu; see section 1.9).
- Press the function key assigned with [CURSOR ON-OFF] (see section 1.8).
- Select [CURSOR ON-OFF] from the [CURSOR] menu (see section 1.7.3).

1.7.2 Cursor data box

Place the cursor on a target/echo to show information for that location in the cursor data box, located at the top-right of the display (see example figure below).

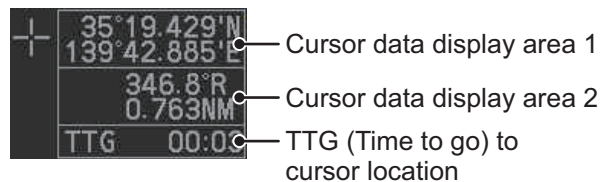

The following data can be shown in the cursor data box.

Radar type	Cursor data display area 1	Cursor data display area 2
IMO-type	Latitude/longitude for the cursor location.	<ul style="list-style-type: none"> • Range and bearing to the cursor location. • X/Y coordinates for the cursor location.
C-type	<ul style="list-style-type: none"> • Latitude/longitude for the cursor location. • Range and bearing to the cursor location. • X/Y coordinates for the cursor location. • Difference between cursor location and Loran/Decca data.* 	
*: Requires [8 LORAN/DECCA] set to [ON] in the [4 CURSOR] menu (located in the [3 CURSOR•EBL•VRM] menu)		

Place the cursor on the cursor data area (1 or 2) in the cursor data box, then press the **left button** to change the displayed information. For IMO-types, data area 1 is fixed at latitude/longitude and cannot be changed.

Note 1: For the X-Y co-ordinates display, the Y-axis is the upper/lower half of the screen, the upper half of the screen is “plus” and the lower part of the screen is “minus”. The X-axis is the left/right-side of the screen, right is “plus”, left is “minus”.

Note 2: Cursor data reads "- - -" when the cursor is placed outside the operational display area.

1.7.3 How to Use the [CURSOR] Menu

Functions that require the use of the cursor, such as EBL offset and zoom, can be activated directly from the [CURSOR] menu. Below is the procedure for choosing cursor-related functions from the [CURSOR] menu.

1. Select the operational display area, then press the **right button**.
The [CURSOR] menu appears.
2. Select the desired function, then left-click.
3. The guidance box shows "XX / EXIT" (XX = function selected). Use the trackball to place the cursor where desired.
Note: You can also select the cursor function, when the cursor is inside the operational display area, by spinning the scrollwheel.
4. Left-click to execute the function selected at step 3.
5. To quit the selected function, right-click when the guidance box shows "XX / EXIT" (XX = function selected).
The table below list the contents of the cursor context menu with a brief description.

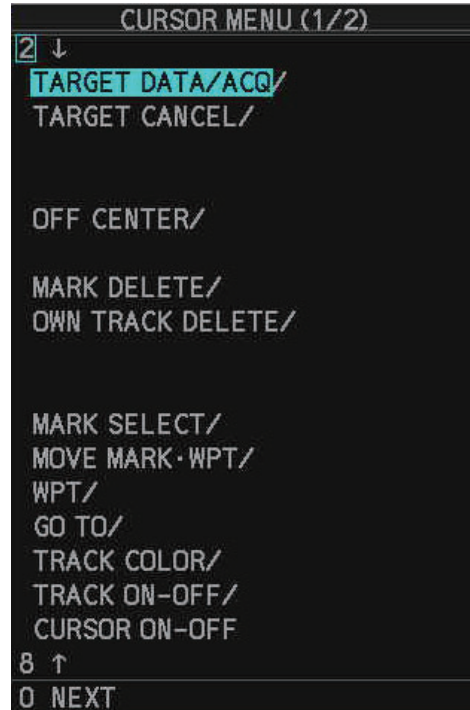

Menu Item	Description
Page 1	
[TARGET DATA / ACQ]	TT: Acquires target; displays data for selected tracked target. AIS: Activates sleeping AIS target; displays data for selected AIS target.
[TARGET CANCEL]	TT: Cancels tracking on selected tracked target. AIS: Sleeps selected AIS target.
[TT TGT DATA / ACQ]	Acquires selected echo as tracked target.
[REF MARK]* ¹	Inscribes reference mark, for target-based speed input.
[EBL OFFSET]	Offsets EBL to measure range and bearing between two targets.
[OFFCENTER]	Shifts screen center to selected location.
[ZOOM]	Zooms selected location.
[MARK DELETE]	Deletes selected mark (plotter mark, origin mark or waypoint mark).
[OWN TRACK DELETE]	Deletes own ship's tracks.
[MAP ALIGN]	Aligns charts (maps) with the radar picture.
[TRAIL ERASER]* ²	Erases trails.
[MARK SELECT]* ²	Opens the [MARK COLOR/SHAPE] window.
[MOVE MARK·WPT]* ²	Moves the selected mark or waypoint.
[WPT]* ²	Inserts a waypoint.
[GO TO]* ²	Selects/deselect a destination.

Menu Item	Description
[TRACK COLOR]* ²	Opens the [CHANGE TRACK COLOR] window.
[TRACK ON/OFF]* ²	Start/stop track recording.
[CURSOR ON/OFF]* ²	Show/hide the cursor.
Page 2	
[TARGET DATA / ACQ SETTING]	Change target tracking settings.
[TARGET CANCEL SETTING]	Change target cancel settings.
[CIRCLE CURSOR]* ²	Insert/remove the circle cursor.
* ¹ : For C-types, this menu item appears on page 2 of the [CURSOR] menu.	
* ² : These menu items only appear for C-types.	

Note 1: Menu items set to [OFF] at [CURSOR MENU SELECT] (located in [9 INITIAL SETTINGS] → page 2 of the [5 OPERATION] menu) are not shown in the [CURSOR] menu.

Note 2: The following [CURSOR] menu items appear for C-types when the cursor is shown.

- [TARGET CANCEL]
- [TT TGT DATA / ACQ]
- [REF MARK]
- [EBL OFFSET]
- [ZOOM]
- [MARK DELETE]
- [MAP ALIGN]
- [TRAIL ERASER]
- [MOVE MARK•WPT]

Note 3: The following items are not shown in the CURSOR menu when the radar is transmitting.

- [TT TGT DATA / ACQ]
- [REF MARK]
- [EBL OFFSET]
- [ZOOM]
- [MAP ALIGN]
- [TRAIL ERASER]

1.7.4 How to change the cursor data attributes (C-type only)

You can change the cursor bearing reference, cursor range unit, cursor size and also align the cursor by latitude/longitude. Changing some of these settings affects the indications in the cursor data display.

1. Open the menu.
2. Select [3 EBL•VRM•CURSOR SET].
3. Select [4 CURSOR]. The [CURSOR] menu appears.

CURSOR	
1	BACK
2	CURSOR BEARING REL/TRUE
3	CURSOR RANGE NM/km/SM/kyd
4	CURSOR SIZE SMALL/LARGE
5	CURSOR L/L ALIGN OFF/ON
6	ENLARGED CURSOR INFO OFF/ON
7	CURSOR COLOR RED/GRN/BLU/YEL/ CYA/MAG/WHT
8	LORAN/DECCA OFF/ON

1. OPERATIONAL OVERVIEW

- Select the item you want to change, referring to the list below.
 - [2 CURSOR BEARING]: Sets the bearing reference.
 - [3 CURSOR RANGE]: Sets the unit of measurement for cursor range.
Note: If a different measurement unit is used for short distances, adjust the setting (see section 1.32.4).
 - [4 CURSOR SIZE]: Sets the cursor size.
 - [5 CURSOR L/L ALIGN]*: Sets whether to align the cursor with latitude/longitude.

Appears when
[CURSOR L/L
ALIGN] is set to
[ON].



- [6 ENLARGED CURSOR INFO]: Sets whether to show enlarged cursor data box contents in a separate window. You can move the enlarged data box with the following procedure:
 - Place the cursor on the enlarged data box, then left-click.
 - Use the trackball to move the data box to the desired location.
 - Left-click to “anchor” the box at the new location.
- [7 CURSOR COLOR]: Sets the color for the cursor.
- [8 LORAN/DECCA]: Sets whether to show LORAN/DECCA data in the cursor data box.

*: For IMO-types, this menu item is located in [MAIN MENU] → [3 NAV TOOLS] → [3 EBL•VRM•CURSOR SET].

- Close the menu.

1.8 Function Keys

Some menu functions and menus can be assigned to a function key. This allows one-touch access to the assigned function or menu.

1.8.1 How to set the function key mode (C-types only)

You can set the function keys to have on of the following modes:

- SINGLE: One function per function key, activated when the key is pressed.
- MULTI: Multiple functions per function key. A function selection window appears when the key is pressed.

To set the function mode, do the following:

- Open the [MAIN MENU].
- Select [9 INITIAL SETTINGS].
- Select [6 FUNCTION KEY SETUP].
- [0 NEXT] to show the second page of the menu.
- Select the appropriate function key whose mode you want to change.
- Select [SINGLE] or [MULTI], as required.
- Close the menu.

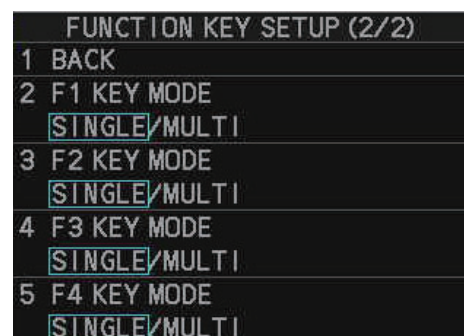

1.8.2 How to use the function keys

To activate an assigned function, press the corresponding function key (**F1**, **F2**, **F3** or **F4**). The pre-assigned (default) functions differ, depending on your radar type (C-types or IMO-type) and the selected mode (C-types only).

Default functions for C-types using [SINGLE] mode and IMO-types

Function key	IMO-type default	C-type default
F1	IR (Interference Rejector)	TRK COLOR SEL
F2	ES (Echo Stretch)	TRK INTVL
F3	AUTO-SEA	MARK SELECT
F4	AUTO-RAIN	TLL

Default function for C-types using [MULTI] mode

F1	F2	F3	F4
2 TRK COLOR SEL	2 TRK INTVL	2 MARK SELECT	2 TLL
3 IR	3 CHART DISPLAY	3 WPT	3 MOB
4 ES	4 NAV AIDS	4 GO TO	4 DISPLAY MODE
5 EAV	5 OWN TRACK DISPLAY	5 TRK COLOR SEL	5 SCREEN SHOT
6 ACE	6 TT-DISP	6 TRK INTVL	6 (Not assigned)
7 AUTO-SEA	7 AIS-DISP	7 CURSOR ON-OFF	7 (Not assigned)
8 AUTO-RAIN	8 ((Not assigned))	8 (Not assigned)	8 (Not assigned)
9 (Not assigned)	9 (Not assigned)	9 (Not assigned)	9 (Not assigned)

To activate an assigned function [MULTI] mode, do the following:

1. Press the function key that contains the function you want to use.
The corresponding menu appears. (**F4** is pressed in the following example.)

F4 KEY EXECUTION
1 TLL
2 MOB
3 DISPLAY MODE
4 SCREEN SHOT
5
6
7
8
9 F4 FUNCTION KEY
0 CLOSE

2. Select the appropriate function.

Note: You can select [9 Fx FUNCTION KEY] (where “x” is the number of the selected function key) to access the function key setup menu.

1.8.3 How to change the function(s) assigned to a key

You can change the function assigned to each key using the following procedure.

1. Open the [MAIN MENU].
2. Select [9 INITIAL SETTINGS].
3. Select [6 FUNCTION KEY SETUP]. The function key setup menu appears.

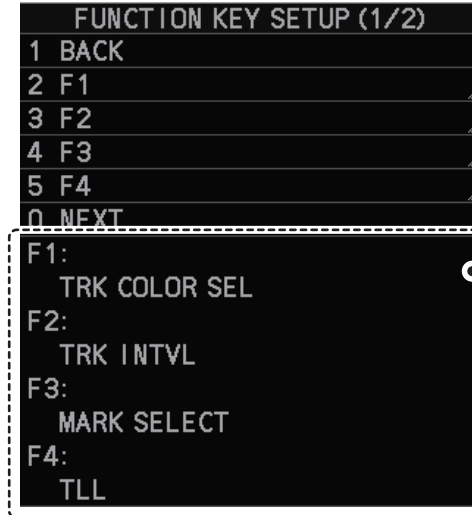

When [SINGLE] is selected as the key mode, the current setting for the function key is shown here. Function keys with [MULTI] selected as their mode are hidden.

4. Select the function key to set up.

Note: If the selected key's mode is set to [MULTI], the function selection menu appears after you select the function key.
5. Referring to the table of available functions below, select a function category, then left-click.

You can check the currently assigned functions in the bottom half of the menu.

Function category	Available functions
[2 ECHO]	CUSTOM SELECT, IR, ES, EAV, NOISE REJ, ANT SELECT, PULSE LENGTH, AUTO-SEA, AUTO-RAIN, TUNE SELECT*4, TX CHANNEL*3, 2ND ECHO REJ, STC CURVE, STC RANGE, PM, SART, ECHO TRAIL, TRAIL T/R, WIPER*1, ACE, ACE HIGH SENSITIVITY, TARGET ANALYZER
[3 STD KEY]	ALERT ACK, STBY TX, HL OFF, EBL OFFSET, ORIENTATION-MODE, OFF CENTER, CU-TM RESET, PI LINE, VECTOR TIME, VECTOR MODE, TARGET LIST, BRILL, MARK, MENU, RANGE UP, RANGE DOWN, ACQ, TARGET DATA, TARGET CANCEL
[4 TT•AIS]	TT-DISP, AIS-DISP, TARGET DATA & ACQ, PAST POSN INTERVAL, REF MARK, CPA LIMIT, CPA, TCPA, AZ1, AZ2, TARGET LIST SORT, TRIAL MANEUVER*2, TRIAL MODE CHANGE*2, ASSOCIATION, AIS MESSAGE, AIS SCALED SYMBOL, CONSORT-DISP*1, GPS BUOY-DISP*1, CONSORT LIST*1, GPS BUOY LIST*1, CONSORT MESSAGES*1
[5 DELETE DATA]	MARK DELETE, MARK ALL DELETE, OWN TRK DELETE, OWN TRK ALL DELETE, TGT TRK DELETE*1, TGT TRK ALL DELETE*1
[6 OPERATION]	BUZZER STOP, ECHO AREA*1, ECHO COLOR, PALETTE, RING(ON/OFF), ZOOM, MOB*2, ALARM1, ALARM2, WATCH ALERT RESET, TLL*1, MAP ALIGN, ANCHOR WATCH, DROP MARK, SCREEN SHOT, CHART DISPLAY*1, NAV AIDS*1, CURSOR ON-OFF*1, CURSOR CENTER/DISPLAY MODE*1

Function category	Available functions
[7 PLOTTER]* ¹	WPT, GO TO, WAYPOINT LIST, MARK SELECT, TRK COLOR SEL, TRK INTVL, PLOTTER, EDIT TRACK, MARK SIZE, WAYPOINT MARK, OWN TRACK DISPLAY, TRK ROUTE CONVERSION, GRID, ENLARGED CURSOR INFO, TRK TEMP DATA DISP, TRK DEPTH DATA DISP
[8 PICTURE]* ¹	PICTURE1 through PICTURE12
* ¹ : C-types only; * ² : IMO-types only; * ³ : Used for SSD radars only; * ⁴ : Used for magnetron radars only.	

6. Repeat the procedure as necessary to set up other function keys.
7. Close the menu.

1.9 How to Customize Operation

Several operation items can be customized to suit your needs.

1. Open the menu.
2. Select [9 INITIAL SETTING].
3. Select [5 OPERATION]. The [OPERATION] menu appears.
4. Referring to the table below, press the menu item number to select the appropriate menu item to customize.

OPERATION(1/2)	
1	BACK
2	MOUSE WHEEL DIR NORMAL/REVERSE
3	KEY BEEP OFF/LOW/MID/HIGH
4	OWN SHIP VECTOR OFF/HDG/COURSE
5	STERN UP RM OFF/ON
6	DISPLAY MODE NORMAL/SIMPLE
7	ICING PREVENTION OFF/ON
8	HDG FINE ADJUST +0. 0°
9	USB MOUSE SPEED 1/2/3/4/5
0	NEXT

Menu items	Description
Page 1	
[2 MOUSE WHEEL DIR]	Sets the direction of the wheel drive (scrollwheel). <ul style="list-style-type: none"> • [NORMAL]: Scroll downwards to increase, or upwards to decrease the value. • [REVERSE]: Scroll directions are reverse of [NORMAL].
[3 KEY BEEP]	Changes the key beep volume. Select [OFF] to silence the key beeps. Select [LOW], [MID], [HIGH] to adjust the volume for key beeps.
[4 OWN SHIP VECTOR]	Select how the own ship vector is displayed. <ul style="list-style-type: none"> • [OFF]: Own ship vector is not displayed. • [HDG]: Vector is displayed in heading direction. • [COURSE]: Vector is displayed in course direction.
[5 STERN UP RM]* ¹	Select [ON] to show [STERN UP RM] orientation in the selection cycle (see section 1.30).
[6 DISPLAY MODE]* ¹	Switch between [SIMPLE] and [NORMAL] display mode. See section 1.4.1 for display examples. Note: TT/AIS settings are not available in the simple display. To change or adjust TT/AIS settings, make the changes/adjustments at the standard display, then switch to the simple display.
<i>Continued on following page</i>	
<i>Continued from previous page</i>	

1. OPERATIONAL OVERVIEW

Menu items	Description																						
[6 SHUTTLE FERRY]* ²	Sets the shuttle ferry mode to use. <ul style="list-style-type: none"> • [OFF]: Shuttle ferry mode is deactivated. • [MODE1]: Shuttle ferry mode is activated. See "Shuttle ferry mode (IMO-types only)" on next page. • [MODE2]: Shuttle ferry mode is activated. See "Shuttle ferry mode (IMO-types only)" on next page. Note: Shuttle ferry mode requires an external switch.																						
[7 ICING PREVENTION]	Select [ON] to rotate the antenna without transmission, to prevent ice buildup. See section 1.54.																						
[8 HDG FINE ADJUST]	Adjusts the heading line location. 0.0°, the default setting, shows the heading line pointing towards the top of the screen.																						
[9 USB MOUSE SPEED]	Adjust the USB mouse sensitivity. A higher value increase the mouse cursor's movement speed.																						
Page 2																							
[2 AUTO COURSE UP RESET]	Select [ON] to enable, or [OFF] to disable the automatic reset of the screen when using COURSE UP orientation and your course is more than 22.5° to either side the center of the screen.																						
[3 DISPLAY SCROLL]* ¹	Select [ON] to enable, [OFF] to disable display scrolling. When set to [ON], move the cursor to the edge of the screen in the direction you want to scroll.																						
[4 CURSOR MENU SELECT]* ¹	Open the [CURSOR MENU SELECT] menu. You can show/hide menu items which appear in the [CURSOR] menu. Select [OFF] to hide, [ON] to show the menu item. <table border="1" data-bbox="549 1021 1321 1550" style="margin: 10px auto;"> <thead> <tr> <th data-bbox="549 1021 932 1057">CURSOR MENU SELECT (1/2)</th> <th data-bbox="932 1021 1321 1057">CURSOR MENU SELECT (2/2)</th> </tr> </thead> <tbody> <tr> <td data-bbox="549 1057 932 1084">1 BACK</td> <td data-bbox="932 1057 1321 1084">1 BACK</td> </tr> <tr> <td data-bbox="549 1084 932 1128">2 TARGET CANCEL OFF/ON</td> <td data-bbox="932 1084 1321 1128">2 TRAIL ERASER OFF/ON</td> </tr> <tr> <td data-bbox="549 1128 932 1173">3 TT TGT DATA/ACQ OFF/ON</td> <td data-bbox="932 1128 1321 1173">3 MARK SELECT OFF/ON</td> </tr> <tr> <td data-bbox="549 1173 932 1218">4 EBL OFFSET OFF/ON</td> <td data-bbox="932 1173 1321 1218">4 MOVE MARK · WPT OFF/ON</td> </tr> <tr> <td data-bbox="549 1218 932 1263">5 OFF CENTER OFF/ON</td> <td data-bbox="932 1218 1321 1263">5 WPT OFF/ON</td> </tr> <tr> <td data-bbox="549 1263 932 1308">6 ZOOM OFF/ON</td> <td data-bbox="932 1263 1321 1308">6 GO TO OFF/ON</td> </tr> <tr> <td data-bbox="549 1308 932 1352">7 MARK DELETE OFF/ON</td> <td data-bbox="932 1308 1321 1352">7 TRACK COLOR OFF/ON</td> </tr> <tr> <td data-bbox="549 1352 932 1397">8 OWN TRACK DELETE OFF/ON</td> <td data-bbox="932 1352 1321 1397">8 TRACK ON-OFF OFF/ON</td> </tr> <tr> <td data-bbox="549 1397 932 1442">9 MAP ALIGN OFF/ON</td> <td data-bbox="932 1397 1321 1442">9 CURSOR ON-OFF OFF/ON</td> </tr> <tr> <td data-bbox="549 1442 932 1487">0 NEXT</td> <td></td> </tr> </tbody> </table>	CURSOR MENU SELECT (1/2)	CURSOR MENU SELECT (2/2)	1 BACK	1 BACK	2 TARGET CANCEL OFF/ON	2 TRAIL ERASER OFF/ON	3 TT TGT DATA/ACQ OFF/ON	3 MARK SELECT OFF/ON	4 EBL OFFSET OFF/ON	4 MOVE MARK · WPT OFF/ON	5 OFF CENTER OFF/ON	5 WPT OFF/ON	6 ZOOM OFF/ON	6 GO TO OFF/ON	7 MARK DELETE OFF/ON	7 TRACK COLOR OFF/ON	8 OWN TRACK DELETE OFF/ON	8 TRACK ON-OFF OFF/ON	9 MAP ALIGN OFF/ON	9 CURSOR ON-OFF OFF/ON	0 NEXT	
CURSOR MENU SELECT (1/2)	CURSOR MENU SELECT (2/2)																						
1 BACK	1 BACK																						
2 TARGET CANCEL OFF/ON	2 TRAIL ERASER OFF/ON																						
3 TT TGT DATA/ACQ OFF/ON	3 MARK SELECT OFF/ON																						
4 EBL OFFSET OFF/ON	4 MOVE MARK · WPT OFF/ON																						
5 OFF CENTER OFF/ON	5 WPT OFF/ON																						
6 ZOOM OFF/ON	6 GO TO OFF/ON																						
7 MARK DELETE OFF/ON	7 TRACK COLOR OFF/ON																						
8 OWN TRACK DELETE OFF/ON	8 TRACK ON-OFF OFF/ON																						
9 MAP ALIGN OFF/ON	9 CURSOR ON-OFF OFF/ON																						
0 NEXT																							
[5 MODE KEY FUNCTION]* ¹	Set the behavior of the [3 MODE] key. <ul style="list-style-type: none"> • [ORIENTATION]: change the orientation mode with each press. • [CURSOR ON-OFF]: Show/hide the cursor with each press. 																						
[6 TRAIL TIME LINK]* ¹	<ul style="list-style-type: none"> • [NO LINK]: Trail time is not linked with changes in range. • [LINK RANGE]: Link [TRAIL TIME] with the range. As the range changes, the trail time is also automatically regulated to show a constant trail. When linked, the trail time indication appears in yellow color. Note 1: When using a range that is valid only when in stand-by mode, the trail time is automatically adjusted to match either the maximum or minimum range available in transmit mode. Note 2: Linking is only applied when [TRAIL TIME] is set to [NORMAL] (see section 1.37.2).																						

Menu items	Description
[7 VECTOR TIME LINK]* ¹	<ul style="list-style-type: none"> • [NO LINK]: Vector time is not linked with changes in range. • [LINK RANGE]: Link vector time with the range. As the range changes, the trail time is also automatically adjusted. When linked, the vector time indication appears in yellow color. <p>Note: When using a range that is valid only when transmitting, the vector time is automatically adjusted to match either the maximum or minimum available range.</p>
* ¹ : For C-types only; * ² : For IMO-types only.	

5. Select the required setting by pressing the menu item number, or spinning the scrollwheel.

Note: Regarding input for [8 HDG FINE ADJUST], when using the number keys, the indication is first selected as a whole. At this time, you can toggle between plus "+" or minus "-". Press the **8 VECTOR MODE** key for "-", press the **2 EBL OFFSET** key for "+". If single digits are highlighted, toggle is not possible. In this case, press the **CANCEL TRAILS** key to re-highlight the whole indication.
6. Press the **ENTER MARK** key to confirm and apply the selection.
7. Close the menu.

Shuttle ferry mode (IMO-types only)

The shuttle ferry mode changes the orientation of the display when the external switch is turned on. (The external switch should be connected to the RS-232C port on the processor unit at installation.)

There are two variations: Standard display ([SHUTTLE FERRY] is set to [OFF]) and reversed display ([SHUTTLE FERRY] is set to [MODE1] or [MODE2]).

When the display is reversed for shuttle ferry mode, the following changes also occur:

- Echoes are displayed 180° opposite to normal display.
- Bearing for speed data is re-calibrated to 180° opposite to normal.
- Wind direction based on speed input is re-calibrated to 180° opposite to normal.
- Where [Mode2] is selected, data input from the gyrocompass is re-calibrated to 180° opposite to normal.

Note: Gyrocompass data input is not re-calibrated for [Mode1].

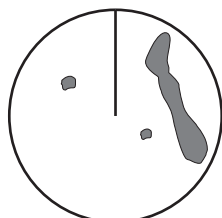

Standard display: Gyro input is displayed normally.

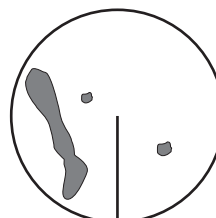

Reversed display: Gyro input is displayed in reverse.

1.10 Heading Input

1.10.1 How to select the data source for heading input

When a gyrocompass is connected, the ship's heading appears on the right side of the screen, in the data display area.

Heading input format can be selected as follows:

1. Open the menu.
2. Select [7 INFORMATION BOX].
3. Select [2 OWN SHIP INFO].
4. Select [2 HDG]. The [HDG] menu appears.
Note: You can also access the HDG menu from the on-screen box. Place the cursor on the [HDG ►] indication in the heading box at the top-right of the screen, then right-click.
5. Select [2 HDG SOURCE], then press the **ENTER MARK** key.
6. Select [GYRO1] or [GYRO2] as appropriate, then press the **ENTER MARK** key.
7. Close the menu.



Note 1: The heading sensor must be able to follow a minimum ROT of 20° per second. Heading sensors with a lesser capability may degrade the performance of echo averaging, trails and TT. The data refresh rate should also be as short as possible. If the refresh rate is too long, the ability to follow courses lessens, thereby affecting the performance of echo averaging, trails and TT.

Note 2: For IMO-types, Where the heading source is other than the heading sensor (for example, and EPFS device), the sensor indication is displayed in yellow color.

1.10.2 How to adjust for magnetic correction (C-types only)

To show true magnetic heading, magnetic data input is required. If your system configuration included a GPS navigator, the corrections required to display correct heading are done automatically. You can also set the magnetic correction manually with the following procedure.

1. Open the menu.
2. Select [7 INFORMATION BOX].
3. Select [2 OWN SHIP INFO].
4. Select [2 HDG].
5. Select [3 MAGNETIC CORRECTION].
6. Select [MANUAL].
7. Enter the required correction value, then press the **ENTER MARK** key.
Note: To toggle between [E] (East) and [W] (West), spin the scrollwheel.
8. Close the menu.

1.11 How to Set Own Ship's Speed

The TT and azimuth stabilized presentation modes require own ship speed input and compass signal. The speed can be entered from a log (STW, SOG) or EPFS (SOG) or manually on the menu.

1.11.1 Automatic speed input (log or EPFS navigator)

1. Open the menu.
2. Select [7 INFORMATION BOX].
3. Select [2 OWN SHIP INFO].
4. Select [3 SPEED]. The [SPEED] menu appears.
Note: You can also access the [SPEED] menu from the on-screen box. Place the cursor on the [SPD ►] indication in the speed box at the top-right of the screen, then right-click.
5. Select [2 SHIP SPEED].
6. Select the appropriate source for automatic speed input, then press the **ENTER MARK** key.

SPEED	
1	BACK
2	SHIP SPEED LOG(BT)/LOG(WT)/ EPFS/MANUAL/REF/ ECDIS
3	MANUAL SPEED INPUT 0. 0kn
4	SET DRIFT OFF/ON 000. 0° 00. 0kn

Note: Changes to the settings here are also applied to the speed calculations for TT targets, true trails, SOG and STW.

Selection	Explanation	Stabilization Mode
[LOG (BT)]* ¹	Log, speed over ground (SOG)	Ground stabilization
[LOG (WT)]	Log, Speed Thru Water (STW)	Sea stabilization
[EPFS]	Speed input by GPS navigator	Ground stabilization
[MANUAL]	Manually input speed	Sea stabilization
[REF]	Echo-referenced speed input	Ground stabilization
[ECDIS]* ²	Speed input by ECDIS	Ground stabilization or Sea Stabilization (Dependent on ECDIS settings).

*¹: Set and drift may be required to display [LOG (BT)] correctly in deep waters. To change set and drift, see section 3.12.

*²: Where [ECDIS] is selected as the speed source, [4 OWN SHIP POSN] in the [OWN SHIP INFO] menu is automatically set to [ECDIS] also. See section 1.12.

7. If you selected [MANUAL] as the speed data source, see section 1.11.2 to set the speed.
8. Close the menu.

Notes on speed input

It should be noted that in determining a target's aspect by radar, the calculation of its true track is dependent on the choice and accuracy of the own ship's course and speed input. A ground-stabilized target plot may accurately calculate the ground track of the target, but the target's heading may be significantly different from its track when experiencing set, drift or leeway. Similarly, a sea stabilized target plot may be inaccurate when own ship and the target, are experiencing different rates of set, drift or leeway.

- IMO Resolution A.823(19) for TT recommends that a speed log to be interfaced with a TT should be capable of providing through-the-water speed (forward speed).
- Be sure not to select a [LOG] option when a speed log is not connected. If the log signal is not provided, the ship speed readout at the top of the screen will be blank. In the event of a log error, enter speed manually.
- When the speed source is set to [LOG(BT)] or [LOG(WT)], and no log signal is present for 30 seconds, the [SPD] is shown as ".*. * kn" and the label "NO LOG(BT) SIGNAL" or "NO LOG(WT) SIGNAL" (in yellow-orange) appears and the alert buzzer sounds.
- When the speed input in use is interrupted or lost, the system automatically changes to another speed input (stabilization reference) and outputs the "SPD SOURCE CHG" alert.
- On IMO-type radars with AIS in use, [MANUAL] and [REF] are shown in gray to indicate they are not available for selection.
- A single-axis water log cannot measure speed when the wind is coming from the leeway direction.
- When [ECDIS] is selected as the speed data source and communication with the ECDIS is interrupted or lost for 30 seconds, the Alert "ECDIS COM ERROR" is released.
- When speed stabilization is changed at the ECDIS and [ECDIS] is selected as the speed data source, the Alert "SPD SOURCE CHG" is released.

1.11.2 Manual speed input

If the speed log is not working, enter speed manually as below. In this case the speed data type is shown as "MANUAL" and is speed thru water (STW). Manual speed input is not available on IMO-type radars when the AIS feature is active.

1. Open the menu.
2. Select [7 INFORMATION BOX].
3. Select [2 OWN SHIP INFO].
4. Select [3 SPEED].
5. Select [2 SHIP SPEED].
6. Select [MANUAL].
7. Select [3 MANUAL SPEED INPUT].
8. Spin the scrollwheel to set the speed.
9. Press the **ENTER MARK** key to confirm the new setting.
10. Close the menu.

1.12 Own Ship Position

1.12.1 How to set the Own Ship position

You can select the data source for own ship's position as follows:

1. Open the menu.
2. Select [7 INFORMATION BOX].
3. Select [2 OWN SHIP INFO].
4. Select [4 OWN SHIP POSN].
Note: You can also access the [OWN SHIP POSN] menu from the on-screen box. Place the cursor on the [POSN ►] indication in the position box at the top-right of the screen, then right-click.
5. Select [2 POSITION SOURCE] or [3 MANUAL L/L INPUT] as appropriate, then press the **ENTER MARK** key.
6. If [2 POSITION SOURCE] is selected at step 2, select the appropriate position source, referring to the list below, then press the **ENTER MARK** key.

OWN SHIP POSN	
1	BACK
2	POSITION SOURCE [EPFS1]/EPFS2/LAN/ ECDIS/DEAD RECKONING
3	MANUAL L/L INPUT 00°00.000'N 000°00.000'E
4	SIO DATA LAN OUTPUT [OFF]/ON
5	COORDINATE SYSTEM [LL] LORAN · DECCA
6	GEODETI C DATUM [WGS-84]/TOKYO POSITIONING SYSTEM GPS

[2 POSITION SOURCE] uses navigational aids. Select the navigational aid to use. Available options are listed with a brief description in the table below:

Available options	Description
[EPFS1]	Use the device assigned as EPFS1 for position data.
[EPFS2]	Use the device assigned as EPFS2 for position data.
[LAN]	Use the device connected to the LAN1 port for position data.
[ECDIS]	Use the connected ECDIS for position data.
[DEAD RECKONING]	Position data is derived from dead reckoning (manual input)

Note 1: When [2 POSITION SOURCE] is set to [DEAD RECKONING], the indication "DR" appears at the bottom of the [OS POSN] box.

Note 2: When [2 POSITION SOURCE] is set to [DEAD RECKONING] or [MANUAL L/L INPUT], the AIS function cannot be used.

Note 3: When [2 POSITION SOURCE] is set to [ECDIS], the source for own ship speed data is automatically set to [ECDIS] also.

Note 4: On IMO-type radars with AIS in use, [DEAD RECKONING] is shown in gray to indicate it is not available for selection.

Note 5: Speed and heading data is required in order to correctly display [DEAD RECKONING] position data.

7. To set [3 MANUAL L/L INPUT], do the following:
 - 1) Select [3 MANUAL L/L INPUT]. The first digit of the latitude is highlighted.
 - 2) Spin the scrollwheel to set the value, then left-click. The cursor moves to the next digit.
You can also use the number keys on the Control Unit to input the value.
 - 3) Repeat step 2 to set the latitude and longitude.

1. OPERATIONAL OVERVIEW

8. To share [OS POSN] data across the same network, do the following:
 - 1) Select [SIO DATA LAN OUTPUT], then press the **ENTER MARK** key.
 - 2) Select [ON], then press the **ENTER MARK** key to share data. To disable [OS POSN] data sharing, select [OFF], then press the **ENTER MARK** key.

Note: A navigational aid must be selected at [2 POSITION SOURCE] to share [OS POSN] across the same network.
9. Close the menu.

1.12.2 How to set the display format for position data (C-types only)

You can set the display format for your position data with the following procedure.

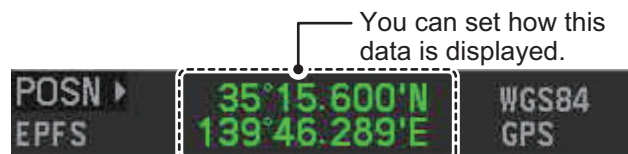

1. Open the menu.
2. Select [7 INFORMATION BOX].
3. Select [2 OWN SHIP INFO].
4. Select [4 OWN SHIP POSN].
5. Select [5 COORDINATE SYSTEM].
6. Select [LL] (Latitude/Longitude) or [LORAN•DECCA] as required. See section 1.57 for details regarding LORAN•DECCA settings.
7. Close the menu.

1.12.3 How to select the datum to use for positioning (C-types only)

You can set the data used for navigation to match the datum used for your charts. If you use different datums, the position (coordinates) indicated on-screen may be different from those shown on your charts. You can change the datum with the following procedure.

1. Open the menu.
2. Select [7 INFORMATION BOX].
3. Select [2 OWN SHIP INFO].
4. Select [4 OWN SHIP POSN].
5. Select [6 GEODETIC DATUM].
6. Select [WGS-84] or [TOKYO] as required.

Note: For configurations with an AIS transponder, select [WGS-84].
7. Close the menu.

1.13 Date and Time

1.13.1 How to switch between UTC and local date/time

Date and time are displayed at the top-right of the screen in the [DATE/TIME] box. You can left-click the date/time indication to toggle between [UTC] format and [LOCAL] format.



1.13.2 How to adjust the local time

You can adjust the local time and switch between UTC/local time from the menu.

To adjust the local time, follow the procedure below.

1. Open the menu.
2. Select [7 INFORMATION BOX].
3. Select [2 OWN SHIP INFO].
4. Select [5 DATE].
5. Select [2 DATE-TIME], then select [UTC] or [LOCAL] as appropriate.
 - [UTC]: Date and time are displayed in UTC format.
 - [LOCAL]: Date and time are shown with the local time offset applied.

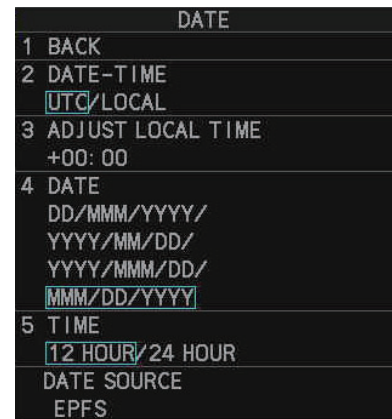

6. Select [3 ADJUST LOCAL TIME], then press the **ENTER MARK** key.

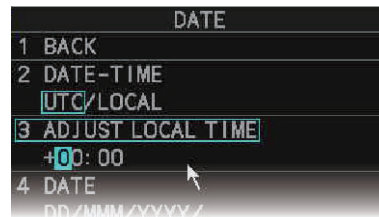

Time indication highlighted as a whole. Toggle between "+" and "-" is possible.

Single digit is highlighted. Toggle between "+" and "-" is not possible.

7. Spin the scrollwheel, or use the number keys to input the desired offset. The offset must be in 30 minute increments.

Note: Regarding input for [3 ADJUST LOCAL TIME], when using the number keys, the indication is first selected as a whole. At this time, you can toggle between plus "+" or minus "-". Press the **8** key for "-", press the **2** key for "+". If single digits are highlighted, toggle is not possible. In this case, press the **CANCEL TRAILS** key to re-highlight the whole indication.

8. Close the menu.

1.13.3 How to change the date/time display format (C-types only)

You can change the manner in which time and date data is displayed.

1. Open the menu.
2. Select [7 INFORMATION BOX].
3. Select [2 OWN SHIP INFO].
4. Select [5 DATE].
5. Select [4 DATE], then select the required display format for the date.
 - [DD/MMM/YYYY]: date appears as “04/JUL/2018”.
 - [YYYY/MM/DD]: date appears as “2018/07/4”.
 - [YYYY/MM/DD]: date appears as “2018/JUL/04”.
 - [MMM/DD/YYYY]: date appears as “JUL/04/2018”.
6. Select [5 TIME], then select the required display format for the time.
7. Close the menu.

1.14 User Settings (IMO-types only)

The user functions shown in the table below can be reset to their default settings by enabling the [PILOT SETTING] option in the [USER SET] menu. Functions not shown in the table below maintain their previous setting.

The unit can store two separate user settings, for the functions listed below, in the internal memory. These settings can also be recalled. Functions not shown in the table below cannot be stored or recalled.

Function		Setting(s)	Menu/On-screen box
GAIN		Maintained as per previous setting.	[GAIN] box
SEA		[AUTO]	[SEA] box
RAIN		[AUTO]	[RAIN] box
TUNE		[AUTO]	[TUNE] box (Magnetron radars only)
TX CH		Maintained as per previous setting. (Solid State radars only)	
Range		[6 NM]	[RANGE] box
Range rings		[OFF]	[MAIN MENU] → [NAV TOOLS] → [RANGE RINGS]
VRM1	Display	[ON]	[VRM1] box
	Distance	[0.250 NM]	
VRM2	Display	[OFF]	[VRM2] box
	Distance	[0.000 NM]	
EBL1	Display	[ON]	[EBL1] box
	Bearing	Maintained as per previous setting.	
	Reference	Maintained as per previous setting.	
EBL2	Display	[OFF]	[EBL2] box
	Bearing	Maintained as per previous setting.	
	Reference	Maintained as per previous setting.	

Continued on following page

Function		Setting(s)	Menu/On-screen box
<i>Continued from previous page</i>			
PI Lines	Display	[OFF]	[PI Line] box
	Interval		
	Orientation		
	Bearing (True or Relative)	Fixed to [TRUE].	-
	Number of PI lines	[OFF]	[MAIN MENU] → [NAV TOOLS] → [PI LINES] → [SET MAXIMUM PI LINE]
Mode (Parallel or Perpendicular)		[MAIN MENU] → [NAV TOOLS] → [PI LINES] → [PI LINE MODE]	
Presentation Mode		[NORTH UP TM]	[PRESENTATION MODE] box
Stabilization mode (Sea/Ground)		[EPFS] (Ground)	[SPEED] box → [SHIP SPEED]
Off-centering		On-centering	OFF CENTER key.*
Target trails	Display, time	[ON], [6 MIN]	[TRAIL MODE] box
	Mode	[TRUE]	[PAST POSN] box
Past position		[OFF]	[PAST POSN] box
Vector mod		[REL]	[VECTOR] box
Vector time		[6 MIN]	
AZ1		[OFF]	[AZ1] box
AZ2		[OFF]	[AZ2] box
TT acquisition mode		[MAN100]	[TT TARGET] → [TT SELECT]
AIS display		[DISP ALL]	[AIS] box
Association		[ON] (TT > AIS)	[MAIN MENU] → [TT•AIS] → [TARGET ASSOCIATION] → [ASSOCIATION TGT TYPE]
Lost Target Alert		[OFF] (Disabled)	LOST TARGET ALERT box
CPA/TCPA alarm	ON/OFF	[ON]	[CPA LIMIT] box
	CPA	[2 NM]	
	TCPA	[12 MIN]	
*: Has the same effect as selecting the True Motion presentation mode.			

1.14.1 How to reset the user settings

1. Open the menu.
2. Select [9 INITIAL SETTINGS].
3. Select [4 USER SETTINGS].
4. Select [PILOT SETTING], then press the **ENTER MARK** key.
5. Select [YES], then press the **ENTER MARK** key.
6. Close the menu.

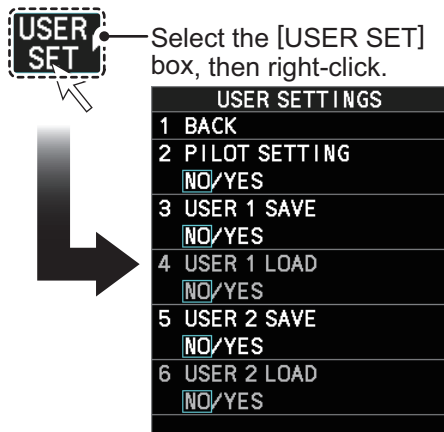

Note 1: Items not shown in the above table keep their previous settings when [PILOT SETTING] is activated.

Note 2: TT tracking is continued after [PILOT SETTING] is activated.

Note 3: The radar map displays the same map as before [PILOT SETTING] is activated.

1.14.2 How to save/load user settings

1. Open the menu.
2. Select [9 INITIAL SETTINGS].
3. Select [4 USER SETTINGS].
4. Select [USER1(2) LOAD] or [USER1(2) SAVE] to recall or save user settings, respectively, then press the **ENTER MARK** key.
5. Select [YES], then press the **ENTER MARK** key.
6. Close the menu.

When loading settings, the following points apply:

- If the newly loaded settings cannot be applied to items not listed in the table above, then these items keep their previous settings.
- TT tracking is continued after the settings are loaded.
- The radar map displays the same map as before the settings were loaded.

1.15 How to Start/Stop Transmission

The radar is ready to transmit when the message "STBY" (C-types) or "RADAR STBY" (IMO-types) appears in the operational display area. Transmission can be started using one of the following procedures:

- **Using the control unit:** Press the **STBY TX** key.
- **Using the on-screen box:** Left-click the  button on the InstantAccess bar™.

When the radar is switched to TX (transmit) status, most settings (such as brilliance, range, pulse width, etc) are restored with the same settings as before standby.

For magnetron radars, it is recommended to place the radar in standby when transmission is not required, to reduce wear on the magnetron. You can also set a "blank sector" where transmission is stopped (see the Installation Manual for details).

How to stop antenna rotation

Antenna rotation can be stopped using one of the following procedures:

- Turn the antenna switch off.
- Turn antenna rotation off from the menu (See installation manual).

Screen freeze

The screen is not refreshed if the screen has frozen. An audio alarm is released 30 seconds after a screen freeze. The **ALARM ACK** (RCU-014) or **ALERT ACK** (RCU-031) key flashes and a contact alert signal is also released. To return the radar to normal operation, turn the radar off, then on again.

Quick start

Provided that the radar was in use and the magnetron (transmitter tube) is still warm, you can switch to transmit mode without the three minute warm-up time. If the radar was turned off by mistake or you wish to restart the radar promptly, wait several seconds before you press the **POWER** switch.

1.16 How to Tune the Receiver (Magnetron Radars Only)

Your magnetron radar has a tuning function (automatic or manual). For solid-state radars, tuning is not available.

1.16.1 How to select the tuning method

1. Select the [TUNE] button, at the top of the InstantAccess bar™, to change the tuning method. The tuning box is displayed as "TUNE AUTO" or "TUNE MAN", depending on the currently selected tuning method.
2. Left-click to toggle between automatic and manual tuning.



Note: The [Tune] button is grayed out and inoperable on FAR-2x58 monitors which are assigned as [SUB] at installation.

1.16.2 How to initialize tuning

Automatic tuning is initialized at installation or after replacing the magnetron. However, if you feel that the automatic tuning is not functioning properly, re-initialize it by following the procedure below.

Note: Automatic tuning is not available on FAR-2x58 monitors which are assigned as [SUB] at installation.

1. Open the menu.
2. Select [2 ECHO], then press the **ENTER MARK** key.

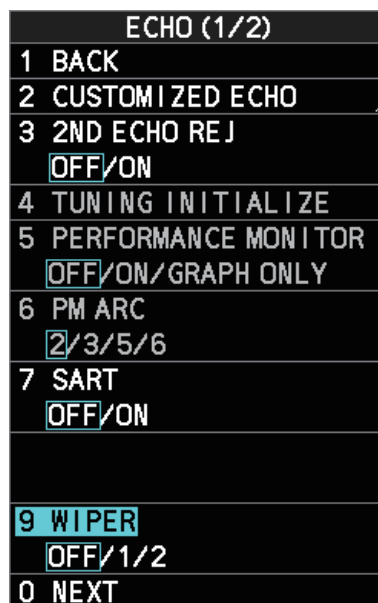

3. Select [4 TUNING INITIALIZE], then press the **ENTER MARK** key. The indication "TUNE INIT" appears in yellow characters at the top of the display during the initialization.
4. Close the menu.

1.16.3 How to tune the receiver manually

1. Select the 48-mile range from the [RANGE] box. Left-click to lower the range; right-click to raise the range.
2. Select manual tuning following the procedure in section 1.16.1.
3. Place the arrow on the tuning level indication.
4. Spin the scrollwheel to adjust tuning. The best tuning point is where the bar graph swings maximum. The tuning control position is indicated with a triangle, displayed inside the tuning bar.

1.17 How to Select a Pulselength

The pulselength in use is indicated on the [PULSE] button of the InstantAccess bar™, at the top-left of the screen.

[PULSE] button

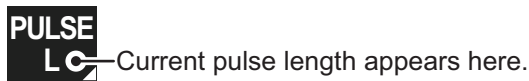

Appropriate pulselengths are preset to individual range scales and function keys. If you are not satisfied with the current pulselength settings, you can change them as shown in the procedure below.

Note: The [Pulselength] button is not shown on FAR-2x58 monitors which are assigned as [SUB] at installation; instead the button is replaced with the indication "SUB".

1.17.1 How to select a pulselength

The pulselength can be changed using the procedure below.

1. Place the cursor in the [PULSE] box at the top left corner of the screen.
2. Left-click to decrease, right-click to increase the pulselength; or spin the scroll-wheel to cycle through pulselengths.

Range	Radar model	(PULSE) indication
0.5 NM	Other than FAR-2x58	S1, S2
	FAR-2x58	S
0.75 NM	Other than FAR-2x58	S1, S2, M1
	FAR-2x58	S, M1
1.5 NM	Other than FAR-2x58	S1, S2, M1, M2
	FAR-2x58	S, M1
3 NM	Other than FAR-2x58	S2, M1, M2, M3
	FAR-2x58	S, M1, M2, L
6 NM/12 NM	Other than FAR-2x58	M1, M2, M3, L
	FAR-2x58	M1, M2, L
24 NM	Other than FAR-2x58	M2, M3, L
	FAR-2x58	M1, M2, L

1.17.2 How to change the preset pulselength

To change the preset pulselength for a range setting, follow the procedure below.

Note: Pulselength presets are not available from FAR-2x58 monitors which are assigned as [SUB] at installation.

1. Open the menu.
2. Select [1 ECHO].
3. Select [2 CUSTOMIZED ECHO].
4. Select [9 PULSE].
5. Select the desired range, then select the required pulselength.

Note: The example figure to the right is taken from a model other than the FAR-2x58. Available pulselengths for FAR-2x58 differ from those shown in this example.

6. Close the menu.

PULSE	
1	BACK
2	0.5NM S1/S2
3	0.75NM S1/S2/M1
4	1.5NM S1/S2/M1/M2
5	3NM S2/M1/M2/M3
6	6NM M1/M2/M3/L
7	12NM M1/M2/M3/L
8	24NM M2/M3/L

1.18 MOB Mark

The MOB mark is used to mark the location where a man-over-board situation has occurred. There are two methods to enter a MOB, as listed below:

- Press the function key assigned with the [MOB] function. For how to assign functions, see section 1.8.3.
- Left-click the [MOB] button on the InstantAccess bar™. (C-types only)

When a MOB mark is inserted, a MOB symbol is immediately inscribed at the own ship location. You can only insert one MOB mark at a time. If a new MOB mark is inserted, the old MOB mark is deleted.

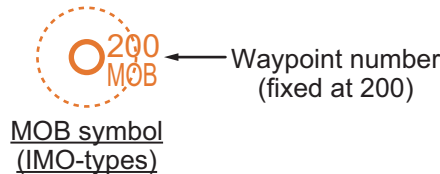
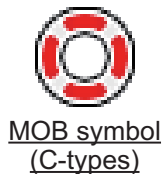

For C-types, the following message appears when a MOB mark is inserted.

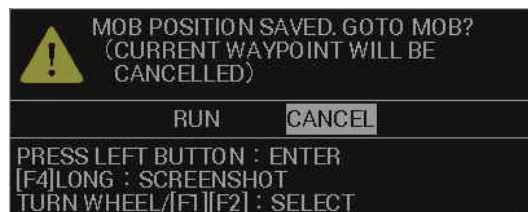

To navigate directly to the MOB, select [RUN]. A course line appears between your vessel and the MOB symbol, on the screen. The line represents the shortest course to the MOB and the arrows on the line indicate the direction of travel.

How to see the MOB pop-up data (C-types only)

Place the cursor on the MOB symbol to show the data pop-up (see example figure to the right). The pop-up data shows the MOB coordinates, ETA and range from own ship.

```
35° 20.6280'N
139° 42.3564'E
07:49 1706.15
```

How to remove the MOB mark

You can remove the MOB mark with one of the following procedures.

- **For C-types**, do one of the following:
 - Press and hold the function key assigned with the MOB function.
 - Place the cursor on the MOB button on the InstantAccess bar™, then left-click.
- **For IMO-types**, do the following:
 1. Place the cursor inside the operational display area, then right-click. The [CURSOR] menu appears.
 2. Select [MARK DELETE].
 3. Select the MOB mark.
 4. Right-click the operational display area to complete the procedure.

1.19 How to Adjust Sensitivity

The gain control adjusts the sensitivity of the receiver.

The proper setting is such that the background noise is just visible on the screen. If you set up for too little sensitivity, weak echoes may be missed. On the other hand excessive sensitivity yields too much background noise; strong targets may be missed because of the poor contrast between desired echoes and the background noise on the display.

To adjust receiver sensitivity, adjust the gain control so background noise is just visible on the screen.

How to adjust the GAIN from the control unit (RCU-014/RCU-031)

Rotate the **GAIN** knob. Rotate anticlockwise to decrease the gain, or clockwise to increase the gain.

How to adjust the GAIN from the on-screen box

1. Place the cursor in the [GAIN] box at the top of the screen.

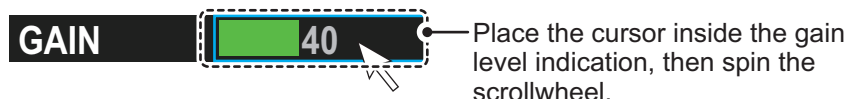

2. Spin the scrollwheel to adjust the gain. The setting range is [0] to [100].

1.20 How to Reduce Sea Clutter

Echoes from waves cover the central part of the display with random signals known as sea clutter. The higher the waves, and the higher the antenna above the water, the further the clutter extends. When sea clutter masks the picture, reduce it with the A/C SEA control, either manually or automatically.

Note 1: When both sea clutter and rain clutter are reduced, the sensitivity is decreased more than when only one is changed. For that reason adjust them carefully.

Note 2: The echo average function (see section 1.24) is useful for reducing reflections from the sea surface. However, high-speed targets are harder to detect than stationary ones when echo average is active.

1.20.1 How to select the method of clutter adjustment

1. Place the cursor in the [SEA AUTO] or [SEA MAN] (whichever is shown) level indication at the top of the display.

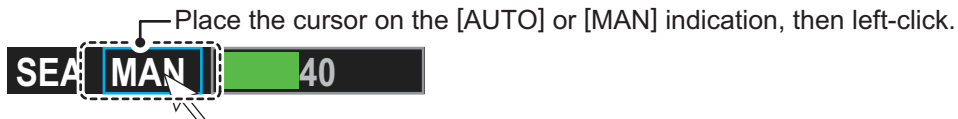

2. Left-click to display [SEA AUTO] or [SEA MAN] as appropriate.

Note: For RCU-031 users, you can also push the **A/C SEA** knob to toggle between automatic and manual clutter reduction.

1.20.2 How to fine-tune sea clutter reduction

Auto A/C SEA allows for fine tuning of the A/C SEA circuit, within ± 20 dB. Accordingly, with the bar reading set to 50, gain is not lowered to minimum as with manual A/C SEA on close-in ranges. Further, the auto A/C SEA level is low because the average value of the original input echo is low in areas where there are no sea surface reflections. For example, when the ship is alongside a quay and the radar picture shows echoes from both land and sea, you can observe the size of the echoes because the STC curve changes with the size of the echoes.

Note: The auto A/C function can erase weak target echoes. Adjust the control carefully, watching the display.

How to fine-tune sea clutter reduction from the control unit (RCU-014/RCU-031)

Rotate the **AC/SEA** knob. Rotate anticlockwise to decrease the AC/SEA, or clockwise to increase the A/C SEA.

How to fine-tune sea clutter reduction from the on-screen box

1. Select [SEA AUTO], following the procedure in section 1.20.1.
2. Place the arrow on level indicator inside the A/C SEA box at the top of the display.

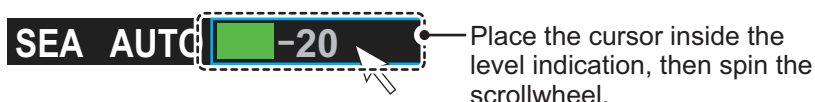

3. While observing the A/C SEA level indicator, spin the scrollwheel to adjust the clutter reduction. The setting range is [-50] to [50].

1.20.3 How to manually reduce sea clutter

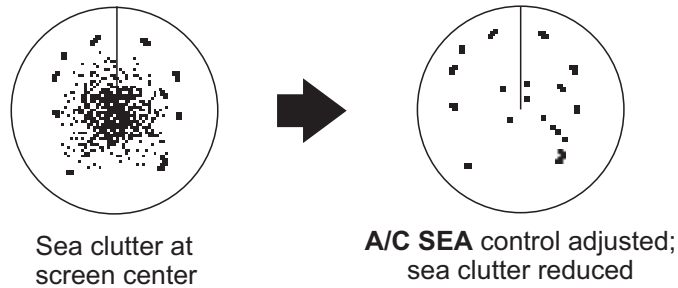

Note: The proper setting of the A/C SEA should be such that the clutter is broken up into small dots, and small targets become distinguishable. If the setting is set too low, targets will be hidden in the clutter, while if the setting is too high, both sea clutter and targets will disappear from the display. In most cases adjust the control until clutter has disappeared to leeward, but a little is still visible windward. Be careful not to remove all sea clutter, because you may erase weak echoes. Further, the possibility of losing weak echoes is greater when you use both A/C SEA and A/C RAIN to reduce clutter.

How to reduce sea clutter manually from the control unit (RCU-014/RCU-031)

Rotate the **AC/SEA** knob. Rotate anticlockwise to decrease the AC/SEA, or clockwise to increase the A/C SEA.

How to reduce sea clutter manually from the on-screen box

1. Select [SEA MAN], following the procedure in section 1.20.1.
2. Place the arrow on level indicator inside the A/C SEA box at the top of the display.

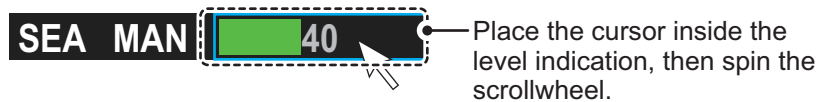

3. While observing the A/C SEA level indicator, spin the scrollwheel to adjust the clutter reduction. The setting range is [0] to [100].

1.20.4 How to use the BERTHING STC function

The [BERTHING STC] function allows you to show the main bang echo, even with the range set at 0.5 NM or less with AUTO SEA at maximum setting. This is particularly useful when attempting to berth, as it gives a clearer view of the berthing area and your ship's location.

To use the [BERTHING STC] function, follow the procedure below.

1. Open the menu.
2. Select [1 ECHO].
3. Select [0 NEXT]. The second page of the [ECHO] menu appears.
4. Select [5 BERTHING STC].
5. Select [ON] to activate, or [OFF] to deactivate, this function.

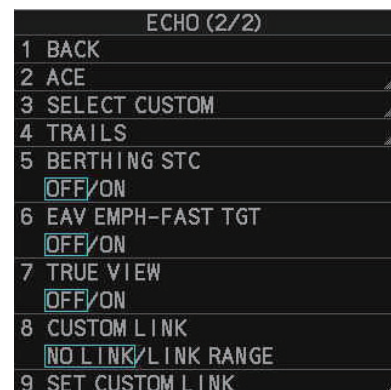

1.21 How to Reduce Rain Clutter

You can reduce clutter caused by rain, either automatically or manually.

Note 1: When both sea clutter and rain clutter are reduced, the sensitivity is decreased more than when only one is changed. For that reason adjust them carefully.

Note 2: The echo average function (see section 1.24) is useful for reducing reflections from the sea surface. However, high-speed targets are harder to detect than stationary ones when echo average is active.

1.21.1 How to select the method of rain clutter reduction

1. Place the cursor in the [RAIN AUTO] or [RAIN MAN] (whichever is shown) level indication at the top of the display.

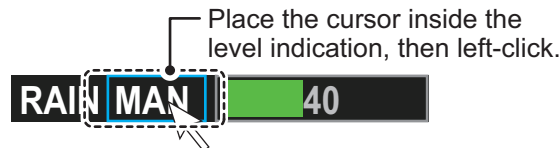

2. Left-click to display [RAIN AUTO] or [RAIN MAN] as appropriate.

Note 1: For RCU-031 users, you can also push the **A/C RAIN** knob to toggle between automatic and manual clutter reduction.

Note 2: Unlike sea clutter reduction, rain clutter cannot be finely adjusted when set to [AUTO].

1.21.2 How to manually reduce the rain clutter

The vertical beam width of the antenna is designed to see surface targets even when the ship is rolling. However, by this design the unit will also detect rain clutter (rain, snow, or hail) in the same manner as normal targets.

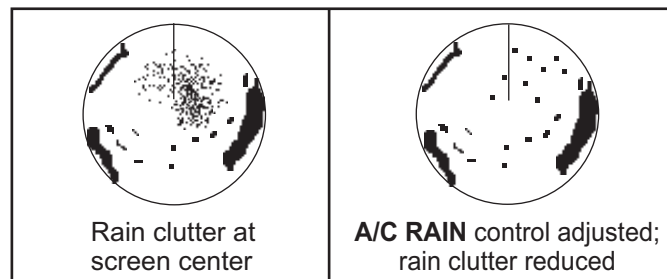

Note: The **A/C RAIN** control adjusts the receiver sensitivity as the **A/C SEA** control does but rather in a longer time period (longer range). The higher the setting the greater the anti-clutter effect. When echoes from precipitation mask solid targets, adjust the **A/C RAIN** control to split up these unwanted echoes into a speckled pattern, making recognition of solid targets easier. Be careful not to remove all rain clutter, because you can erase weak echoes. Further, the possibility of losing weak echoes is greater when you use both **A/C RAIN** and **A/C SEA** to reduce clutter.

How to fine-tune rain clutter reduction from the control unit (RCU-014/RCU-031)

Rotate the **A/C RAIN** knob. Rotate anticlockwise to decrease the A/C RAIN, or clockwise to increase the A/C RAIN.

How to fine-tune rain clutter reduction from the on-screen box

1. Select [RAIN MAN], following the procedure in section 1.21.1.

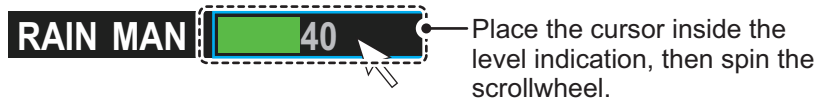

2. While observing the A/C RAIN level indicator, spin the scrollwheel to increase or decrease the level. 100 levels (0-100) are available.

Note: The detection range is reduced when the RAIN is used to show targets in rain. Generally, the amount of rain, TX pulse length and TX frequency are factors in determining how the detection range is affected. The figure below illustrates this.

How to interpret the graph

Using the graph below as an example, a radar target originally detected on the 8 NM range can only be detected in rain at the ranges shown below:

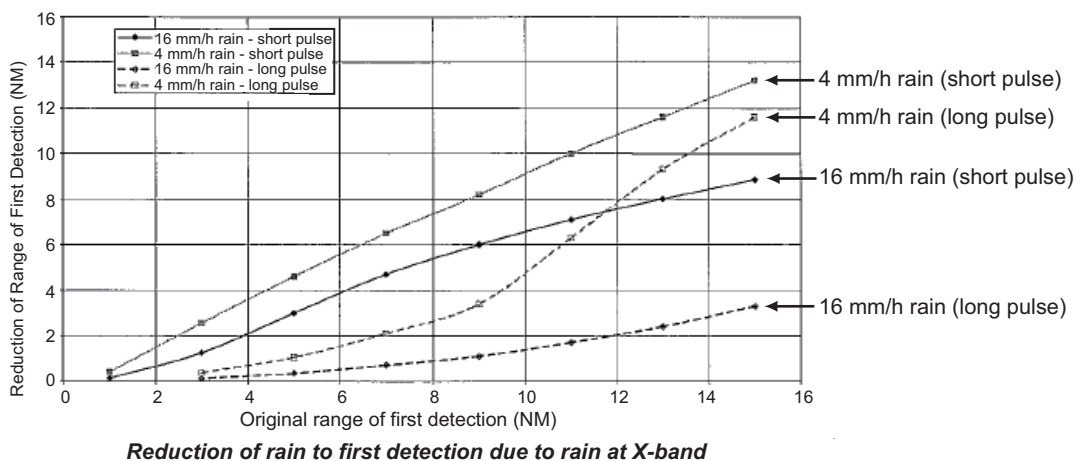
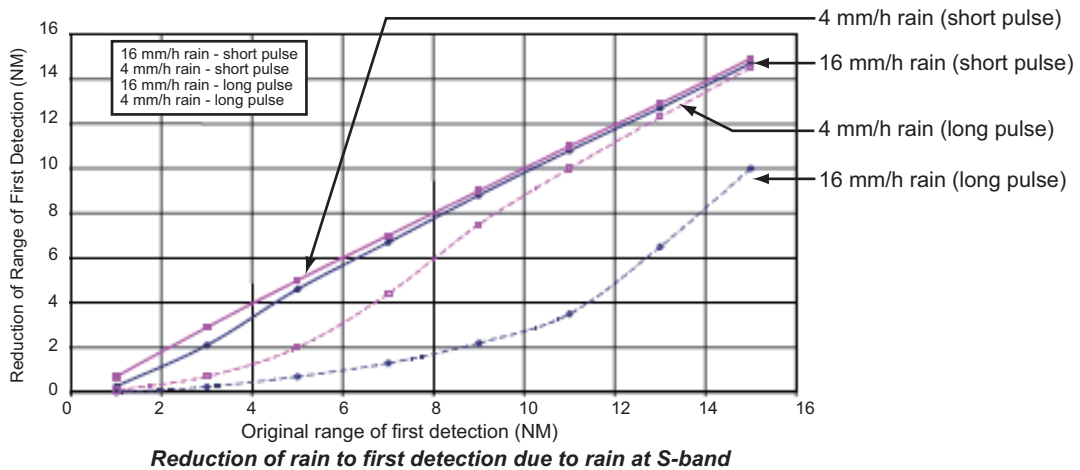

The author thanks the International Electrotechnical Commission (IEC) for permission to reproduce Information from its International Standard IEC 62388 ed.1.0 (2007). All such extracts are copyright of IEC, Geneva, Switzerland. All rights reserved. Further information on the IEC is available from www.iec.ch. IEC has no responsibility for the placement and context in which the extracts and contents are reproduced by the author, or is IC in any way responsible for the other content or accuracy therein.

Accordingly, the short pulse may be preferable in rain on ranges less than 10 NM.

1.22 Interference Rejector

Mutual radar interference can occur in the vicinity of another shipborne radar operating in the same frequency band. It is seen on the screen as a number of bright spikes either in irregular patterns or in the form of usually curved spoke-like dotted lines extending from the center to the edge of the picture. Activating the interference rejector circuit can reduce this type of interference. The interference rejector is a kind of signal correlation circuit. It compares the received signals over successive transmissions and reduces randomly occurring signals. There are three levels of interference rejection depending on the number of transmissions that are correlated.

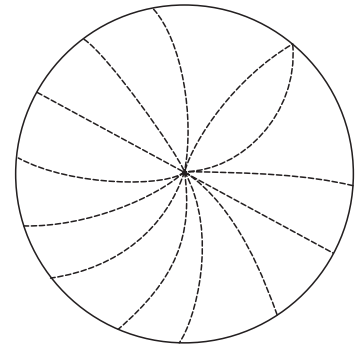

You can access this feature from the InstantAccess bar™, or from the menu. The available settings are: [OFF], [1], [2] or [3].

How to reject interference from the InstantAccess bar™

To adjust the interference rejector, select the [IR] button () on the InstantAccess bar™, then left-click to cycle through the rejection levels.

The available settings, in cyclic order, are: [OFF] → [1] → [2] → [3] → [OFF]...

Level [3] provides the highest level of rejection.

How to reject interference from the menu

1. Open the menu.
2. Select [1 ECHO].
3. Select [2 CUSTOMIZED ECHO].
 - Note:** You can also right-click the [PICTURE] box to access this menu.
4. Select [2 INT REJECTOR].
5. Select the required setting.
6. Close the menu.

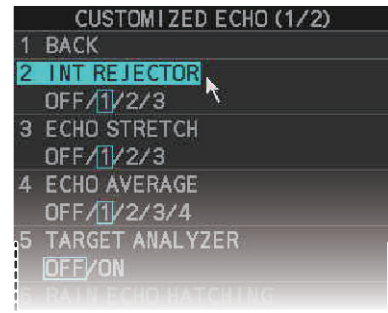

Note: When multiple radars using the same frequency are nearby, interference may appear in a similar manner to that shown in the figure to the right. If this kind of interference appears, do one of the following:

- Press the **HL OFF** key, or click the [HL OFF] button on the InstantAccess bar™.
- Change the range.

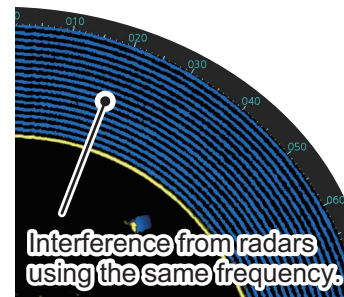

1.23 Echo Stretch

The echo stretch feature enlarges targets in the range and bearing directions to make them easier to see, and it is available on any range. There are three types of echo stretch, 1, 2 and 3, and the higher the number the greater the amount of stretch.

Note: The echo stretch magnifies not only small target pips but also returns (clutter) from sea surface, rain and radar interference. For this reason, make sure these types of interference have been sufficiently reduced before activating the echo stretch.

You can access this feature from the InstantAccess bar™, or from the menu. The available options are: [OFF], [1], [2] or [3].

How to use echo stretch from the InstantAccess bar™

To set echo stretch, select the [ES] button () on the InstantAccess bar™, then left-click to cycle through the settings.

The available settings, in cyclic order, are: [OFF] → [1] → [2] → [3] → [OFF]...

How to use echo stretch from the menu

1. Open the menu.
2. Select [1 ECHO].
3. Select [2 CUSTOMIZED ECHO].
4. Select [3 ECHO STRETCH].
5. Select the required setting.
6. Close the menu.

1.24 Echo Averaging

The echo averaging feature effectively reduces sea clutter. Echoes received from stable targets such as ships appear on the screen at almost the same position every rotation of the antenna. On the other hand, unstable echoes such as sea clutter appear at random positions.

To distinguish real target echoes from sea clutter, echoes are averaged over successive picture frames. If an echo is solid and stable over successive frames, it is presented in its normal intensity. Sea clutter is averaged over successive scans and its brilliance reduced, making it easier to discriminate real targets from sea clutter.

Echo averaging uses a scan-to-scan signal correlation technique based on the true motion over the ground of each target. Thus, small stationary targets such as buoys will be shown while reducing random echoes such as sea clutter. However, true echo averaging is not effective for picking up small targets running at high speeds over the ground.

Note 1: With echo average active it is harder to detect high-speed targets than stationary ones.

Note 2: Do not use the echo averaging function under heavy pitching and rolling; loss of targets can result.

Note 3: Echo averaging requires heading, position and speed data.

Before using the echo averaging function, reduce sea clutter with the A/C SEA control. Leave a little sea clutter on the screen so as not to erase weak targets. The available settings options are shown in the table below.

Setting (level)	Description
[OFF]	Echo averaging is not enabled
[1], [2]	Detects targets hidden in sea clutter. [2] is more effective than [1] in detecting targets hidden in strong sea clutter. However, [1] is more effective than [2] in displaying high-speed targets. Select the setting best suited to current conditions. For effective monitoring of high-speed craft, you should use [2] together with the Wiper function.
[3]	Stably displays unstable targets; distinguishes high-speed craft.
[4]	Assists in distinguishing net floats better.

Note: Setting level [4] is available for C-types only.

You can access this feature from the InstantAccess bar™, or from the menu.

How to adjust the echo average function from the InstantAccess bar™

Select the [EAV] button () on the InstantAccess bar™, then left-click to select the desired level of echo averaging.

How to use the echo average function from the menu

1. Open the menu.
2. Select [1 ECHO].
3. Select [2 CUSTOMIZED ECHO].
4. Select [4 ECHO AVERAGE].
5. Select the required setting.
6. Close the menu.

How to highlight fast-moving targets

Normally, when echo averaging is in use, fast-moving targets may be displayed weakly, or not at all. The fast target emphasis function highlights fast-moving targets, but can also highlight sea-surface reflections and other noise.

To use the fast target emphasis function, follow the procedure below.

1. Open the menu.
2. Select [1 ECHO].
3. Select [0 NEXT].
4. Select [6 EAV EMPH-FAST TGT].
5. Select [ON] or [OFF] as appropriate.
6. Close the menu.

1.25 Automatic Clutter Elimination (ACE) Function

This radar has the Automatic Clutter Elimination (ACE) function. This function detects sea and rain clutter from received echoes' and automatically reduces sea and rain clutter according to the Automatic Clutter Elimination (ACE) threshold setting.

Note: Use this function with caution. Weak target echoes may disappear from the screen.

1.25.1 How to turn the Automatic Clutter Elimination (ACE) function on/off

You can activate/deactivate the ACE function with one of the two methods outlined below.

From the InstantAccess bar™

Place the cursor on the [ACE] button (), then left-click to toggle between [ON] and [OFF].

From the menu

1. Open the menu.
2. Select [1 ECHO].
3. Select [2 CUSTOMIZED ECHO].
4. Select [0 NEXT].
5. Select [4 ACE].
6. Select [ON] or [OFF] as appropriate, then press the **ENTER MARK** key.
7. Close the menu.

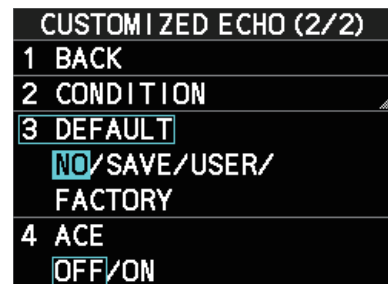

When [ACE] is activated, the [SEA] box and [RAIN] box are gray colored and cannot be adjusted, and the echo averaging function is disabled. The [GAIN] box changes to [GAIN ACE], as shown in the figure below.

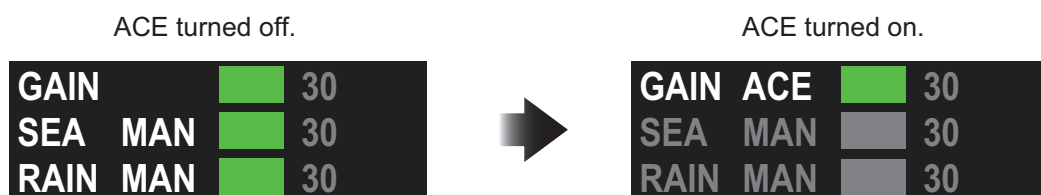

Note: When [PERFORMANCE MON] (see section 1.50) or [SART] (see section 2.3) is [ON], [ACE] is disabled and cannot be activated.

1.25.2 How to adjust the gain in Automatic Clutter Elimination (ACE) mode

Rotate the **GAIN** knob to adjust the sensitivity.

ACE can also be adjusted by placing the cursor inside the [GAIN ACE] level indication, then spinning the scrollwheel.

1.25.3 How to get high sensitivity

When the ACE function is [ON], the high sensitivity mode is also available. High sensitivity mode has three levels ([1], [2], [3]), with [3] applying the highest gain.

To use high sensitivity mode, a function key must be assigned with the [ACE HIGH SENSITIVITY] function (see section 1.8). To activate the ACE feature, press the assigned function key.

You can select the level of sensitivity for high sensitivity mode as follows:

1. Open the menu.
2. Select [1 ECHO], then press the **ENTER MARK** key.
3. Select [0 NEXT].
4. Select [2 ACE], then press the **ENTER MARK** key. The [ACE] menu appears.
5. Select [2 SIGNAL ENHANCEMENT], then press the **ENTER MARK** key.
6. Select the level from [1], [2] or [3].
7. Close the menu.

ACE	
1	BACK
2	SIGNAL ENHANCEMENT
	1/2/3
3	SUPPRESS SECTOR
	START : 000 °
	ANGLE : 000 °

1.25.4 How to suppress false echoes

When the ACE function is [ON], the echo signals can appear on the screen at positions where there is no target or disappear when there are targets (see section 2.2). You can suppress these false echoes.

Note: This procedure is only available when the Automatic Clutter Elimination (ACE) function is [ON].

1. Open the menu.
2. Select [1 ECHO], then press the **ENTER MARK** key.
3. Select [0 NEXT].
4. Select [2 ACE], then press the **ENTER MARK** key.
5. Select [3 SUPPRESS SECTOR], then press the **ENTER MARK** key.
6. Spin the scrollwheel, or use the number keys, to set the start angle for sector suppression.
 - If you use the number keys, the cursor moves from left to right. When all three digits are input, the cursor moves to the ANGLE item.
 - If you use the scrollwheel, left-click when the start angle is set.
 - To cancel any changes, press the **ENTER MARK** key.
7. Left-click, or press the **ENTER MARK** key to confirm the start angle. The cursor moves to the [ANGLE] item.
8. Spin the scrollwheel, or use the number keys, set the angle range of the sector to be suppressed.
 - If you use the number keys, the cursor moves from left to right. When all three digits are input, the setting process is complete.
 - If you use the scrollwheel, left-click when the angle range is set.
 - To cancel any changes, press the **ENTER MARK** key.
9. Close the menu.

1.26 Noise Rejector

White noise can show itself on the screen as random “speckles” spread over the entire radar image. This equipment reduces the white noise, then improves the on-screen S/N ratio by processing the weighted moving average filter for the received echoes in the range direction.

Note: Use this function with caution. Weak target echoes may disappear from the screen or the range resolution may worsen.

To remove this noise do the following:

1. Open the menu.
2. Select [1 ECHO].
3. Select [2 CUSTOMIZED ECHO].
4. Select [7 NOISE REJECTOR].
5. Select [OFF] or [ON] as appropriate, then press the **ENTER MARK** key. The indication for noise rejection is located at the top-left of the screen.
The indication changes according to the selected setting.
6. Close the menu.



1.27 Wiper

The wiper feature automatically reduces the brilliance of weak signals (noise, sea clutter, rain clutter, etc.) and unwanted signals such as radar interference to clear the picture of unwanted echoes. Its effect depends on the wiper setting used and whether each averaging is turned on or off, as described below.

	Wiper setting 1	Wiper setting 2
Echo averaging [OFF]	Condition A	Condition A
Echo averaging on([1] through [4])	Condition A	Condition B

Condition A: The brilliance of unwanted weak echoes, such as noise, sea clutter and rain clutter, is reduced to clear up the picture.

Condition B: Echo averaging is automatically activated when the wiper feature is turned on, allowing you to instantly see how the picture is affected with echo averaging turned off and turned on.

Note 1: The [WIPER] function is not available when [TRUE VIEW] (located on page 2 of the [ECHO] menu) is set to [ON].

Note 2: The [WIPER] function requires valid data input for position, speed and heading.

To activate the wiper feature, do the following:

1. Open the menu.
2. Select [1 ECHO].
3. Select [9 WIPER].
4. Select the desired setting.
The options are: [OFF], [1] or [2].
5. Close the menu.

1.28 How to Preset Controls for a Specific Navigation Purpose

Every time your navigating environment or task changes, you must adjust the radar, which can be a nuisance in a busy situation. Instead of changing radar settings case by case, it is possible to assign the function keys to provide optimum settings for often-encountered situations.

The radar's internal computer offers several picture preset options to be assigned to each function key for your specific navigating requirements. For instance, one of the presets is [ROUGH SEA], and is designed to be used in heavy rain.

Three user-programmable presets are also provided (labeled as [CUSTOM1], [CUSTOM2] and [CUSTOM3]), so that you can have the radar automatically set to those conditions which are not covered by the provided setup options.

Below are the preset options provided with this radar.

Preset	Description
[CUSTOM1], [CUSTOM2] and [CUSTOM3]	User-defined custom settings.
[NEAR]	Optimum setting for short range detection using a range scale of 3 NM or less on calm seas.
[FAR]	Optimum setting for long range detection, on a range scale of 6 NM or larger.
[NEAR BUOY]	Optimum setting for detecting buoys within 3 NM range.
[FAR BUOY]	Optimum setting for detecting buoys on a range scale of 6 NM or larger.
[ROUGH SEA]	Optimum setting for rough weather or heavy rain.
[SHIP]	Optimum setting for detecting other vessels.
[HARBOR]	Optimum setting for harbor berthing.
[BIRD]	Optimum setting for detecting birds.
[COAST]	Optimum setting for coastal travel.

Note: For C-types, you can change the name of the presets (see section 1.28.5). This section uses the default names for all procedures and examples.

Each picture option defines a combination of several radar settings for achieving optimum setup for a particular navigating situation. These include gain, target analyzer, hatching, ACE, ACE gain, interference rejector, echo stretch, echo average, noise rejector, automatic anti-sea and anti-rain clutter, video contrast, near STC range/curve, pulse length and sea and radar conditions.

Changing these features from the [CUSTOMIZED ECHO] menu changes the original function key settings. To restore the original settings for a particular customize option, it is necessary to select the default setting. For this reason, we recommended that you use the user-programmable presets ([CUSTOM1], [CUSTOM2] or [CUSTOM3]) when frequent adjustment of the radar image is necessary.

The default settings for the custom presets are listed on the following pages.

1. OPERATIONAL OVERVIEW

Default settings - models other than FAR-2x58

	IR	ES	EA	NR	AUTO SEA	AUTO RAIN	TARGET ANALYZER*	HATCHING*
CUSTOM1	1	1	1	OFF	MAN-30	MAN-0	OFF	OFF
CUSTOM2	1	1	1	OFF	AUTO-30	MAN-0	OFF	OFF
CUSTOM3	1	1	1	OFF	MAN-30	MAN-0	OFF	OFF
NEAR	1	1	1	OFF	MAN-30	MAN-0	OFF	OFF
FAR	1	2	1	OFF	AUTO-40	MAN-0	OFF	OFF
NEAR BOUY	1	1	2	OFF	MAN-30	MAN-0	OFF	OFF
FAR BUOY	1	2	2	OFF	AUTO-30	MAN-0	OFF	OFF
ROUGH SEA	1	OFF	2	OFF	MAN-50	MAN-40	OFF	OFF
SHIP	1	2	1	OFF	MAN-30	MAN-0	OFF	OFF
HARBOR	1	OFF	1	OFF	MAN-30	MAN-0	OFF	OFF
BIRD	1	OFF	1	OFF	MAN-30	MAN-0	OFF	OFF
COAST	1	OFF	OFF	OFF	MAN-30	MAN-0	OFF	OFF

	STC CURVE	STC RANGE	LOW LEVEL ECHOES	NEAR STC CURVE*	NEAR STC RANGE*	GAIN	ACE	ACE GAIN	VIDEO CONTRAST
CUSTOM1	3	8	0	3.5	2.0	85	OFF	50	2-B
CUSTOM2	3	8	0	3.5	2.0	85	OFF	50	2-C
CUSTOM3	3	8	0	3.5	2.0	85	ON	50	2-B
NEAR	3	8	0	3.5	2.0	85	OFF	50	1-B
FAR	3	8	0	3.5	2.0	85	ON	60	4-B
NEAR BOUY	3	8	0	3.5	2.0	85	OFF	50	1-C
FAR BUOY	3	8	0	3.5	2.0	85	OFF	50	4-C
ROUGH SEA	3	9	0	3.5	3.0	85	OFF	35	2-C
SHIP	3	8	0	3.5	2.0	85	ON	50	2-B
HARBOR	3	8	0	3.5	2.0	75	ON	50	1-C
BIRD	3	8	0	3.5	2.0	85	OFF	50	3-C
COAST	3	8	0	3.5	2.0	85	OFF	50	2-C

*: Available for C-type radars only.

Default settings - FAR-2x58 only

	IR	ES	EA	NR	AUTO SEA	AUTO RAIN	TARGET ANALYZER*	HATCHING*
CUSTOM1	2	OFF	OFF	OFF	MAN-30	MAN-0	OFF	OFF
CUSTOM2	2	2	1	OFF	MAN-30	MAN-0	OFF	OFF
CUSTOM3	2	OFF	2	OFF	MAN-30	MAN-0	OFF	OFF
NEAR	2	OFF	OFF	OFF	MAN-60	MAN-0	OFF	OFF
FAR	2	OFF	OFF	OFF	MAN-30	MAN-0	OFF	OFF
NEAR BOUY	2	2	3	ON	MAN-30	MAN-0	OFF	OFF
FAR BUOY	2	OFF	OFF	OFF	MAN-30	MAN-0	OFF	OFF
ROUGH SEA	2	OFF	OFF	OFF	MAN-30	MAN-0	OFF	OFF
SHIP	2	OFF	2	OFF	MAN-60	MAN-0	OFF	OFF
HARBOR	2	OFF	OFF	OFF	MAN-30	MAN-0	OFF	OFF
BIRD	2	OFF	OFF	OFF	MAN-30	MAN-0	OFF	OFF
COAST	2	OFF	OFF	OFF	MAN-30	MAN-0	OFF	OFF

	STC CURVE	STC RANGE	LOW LEVEL ECHOES	NEAR STC CURVE*	NEAR STC RANGE*	GAIN	ACE	ACE GAIN	VIDEO CONTRAST
CUSTOM1	3	0	0	3.5	3.0	80	OFF	50	1-B
CUSTOM2	3	0	0	3.5	3.0	80	OFF	50	2-B
CUSTOM3	3	0	0	3.5	3.0	80	OFF	50	1-B
NEAR	3	0	0	3.5	3.0	80	OFF	50	2-A
FAR	3	0	0	3.5	3.0	80	OFF	50	1-B
NEAR BOUY	3	0	0	3.5	3.0	80	OFF	50	3-B
FAR BUOY	3	0	0	3.5	3.0	80	OFF	50	1-B
ROUGH SEA	3	0	0	3.5	3.0	80	OFF	50	1-B
SHIP	3	0	0	3.5	3.0	80	OFF	50	2-A
HARBOR	3	0	0	3.5	3.0	80	OFF	50	1-B
BIRD	3	0	0	3.5	3.0	80	OFF	50	2-B
COAST	3	0	0	3.5	3.0	80	OFF	50	2-B

*: Available for C-type radars only.

Default settings for [PULSELENGTH] - models other than FAR-2x58

	0.125 NM to 0.5 NM	0.75 NM	1 NM*	1.5 NM	2 NM*	3 NM
CUSTOM1	S1	S1	S1	S2	S2	M1
CUSTOM2	S1	S1	S1	S2	S2	M1
CUSTOM3	S1	S1	S1	S2	S2	M1
NEAR	S1	S1	S1	S2	S2	M1
FAR	S1	S1	S1	S2	S2	M1
NEAR BOUY	S1	S1	S1	S2	S2	M1
FAR BUOY	S1	S1	S1	S2	S2	M1
ROUGH SEA	S1	S1	S1	S2	S2	M1
SHIP	S1	S1	S1	S2	S2	M1
HARBOR	S1	S1	S1	S2	S2	M1
BIRD	S1	S1	S2	S2	M1	M1
COAST	S1	S1	S1	S2	S2	M1

	4 NM*	6 NM	8 NM*	12 NM	16 NM*	24 NM
CUSTOM1	M1	M2	M2	L	L	L
CUSTOM2	M1	M2	M2	L	L	L
CUSTOM3	M1	M2	M2	L	L	L
NEAR	M1	M2	M2	M3	M3	L
FAR	M1	M3	M3	L	L	L
NEAR BOUY	M1	M2	M2	M3	M3	L
FAR BUOY	M1	M3	M3	L	L	L
ROUGH SEA	M1	M2	M2	M3	M3	L
SHIP	M1	M2	M2	L	M3	L
HARBOR	M1	M2	M2	M3	M3	L
BIRD	M1	M2	M2	M3	L	L
COAST	M1	M2	M2	M3	M3	L

*: Available for C-types only.

Default settings for [PULSELENGTH] - FAR-2x58 only

	0.125 NM to 0.5 NM	0.75 NM	1 NM*	1.5 NM	2 NM*	3 NM
CUSTOM1	S	S	S	M1	M1	M1
CUSTOM2	S	S	S	M1	M1	M1
CUSTOM3	S	S	S	M1	M1	M1
NEAR	S	S	S	M1	M1	M1
FAR	S	S	S	M1	M1	M2
NEAR BOUY	S	M1	M1	M1	M1	M1
FAR BUOY	S	S	S	M1	M1	M1
ROUGH SEA	S	S	S	M1	M1	M1
SHIP	S	S	S	M1	M1	M1
HARBOR	S	S	S	M1	M1	M1
BIRD	S	S	S	M1	M1	M1
COAST	S	S	S	M1	M1	M2

	4 NM*	6 NM	8 NM*	12 NM	16 NM*	24 NM
CUSTOM1	M1	M2	M2	M2	L	L
CUSTOM2	M1	M2	M2	L	L	L
CUSTOM3	M1	M2	M2	L	L	L
NEAR	M1	M2	M2	L	L	L
FAR	M1	M1	M1	L	L	L
NEAR BOUY	M2	L	L	L	L	L
FAR BUOY	M1	M1	M1	L	L	L
ROUGH SEA	M1	M1	M1	L	L	L
SHIP	M1	M2	M2	L	L	L
HARBOR	M1	M1	M1	L	L	L
BIRD	M1	M2	M2	L	L	L
COAST	M2	M2	M2	L	L	L

*: Available for C-types only.

1.28.1 How to select a customized echo

Left-click the [CUSTOMIZE ECHO] box at the top left of the screen to cycle through the options and select a customized echo option.

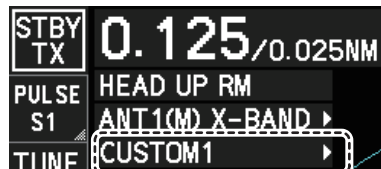

The available options depend on the settings selected for [3 SELECT CUSTOM] in the [ECHO] menu. See section 1.28.5.

Note: For C-types, if the customization is linked with a range (see section 1.28.7), the indication appears in yellow color.

1.28.2 How to edit a customized echo

1. Select a customize echo option to edit (see section 1.28.1).
 2. Open the menu.
 3. Select [1 ECHO].
 4. Select [2 CUSTOMIZED ECHO].
 5. Set the items below referring to the sections shown.
 - [2 INT REJECTOR] : section 1.22
 - [3 ECHO STRETCH] : section 1.23
 - [4 ECHO AVERAGE] : section 1.24
 - [5 TARGET ANALYZER]* : section 1.38
 - [6 HATCHING]* : section 1.38
 - [7 NOISE REJECTOR] : section 1.26
 - [8 VIDEO CONTRAST TYPE]
 - [9 PULSE] : section 1.17
 - [2 CONDITION] : section 1.28.2
 - [4 ACE] : section 1.25
- *: Available for C-type radars only.

Note: To set [2 CONDITION] and [4 ACE], select [0 NEXT] to show the second page of the [CUSTOMIZED ECHO] menu.

6. Select [8 VIDEO CONTRAST TYPE], then press the **ENTER MARK** key.
7. Select [1], [2], [3] or [4] (Dynamic Range) or [A], [B], [C] (Curve) as appropriate then press the **ENTER MARK** key. Video contrast and curve change depending on setting for [VIDEO CONTRAST] (set at installation), as shown in the figure below.

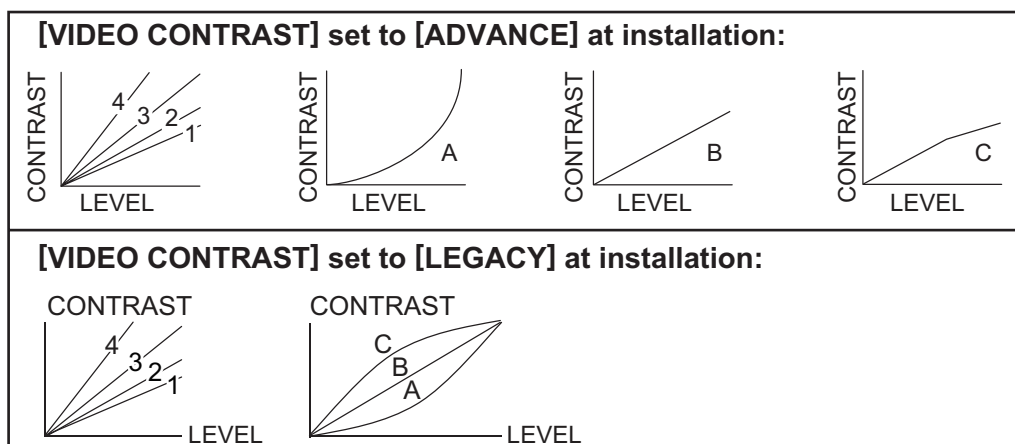

1 to 4: Control dynamic range. 1 provides the widest dynamic range; 4 is the narrowest dynamic range.

A: Low level echo brilliance is reduced and noise and clutter are also reduced.

B: Low and high level echoes are displayed evenly.

C: High level echoes' outer edge has gradation to indicate the echo level, with the higher level echo at the core.

8. Select [0 NEXT] to show the next menu page.
9. Select [2 CONDITION].
10. Select [2 STC CURVE].
11. Select the appropriate setting for the current sea conditions, then press the **ENTER MARK** key. A higher setting is recommended for rough weather.

1. OPERATIONAL OVERVIEW

12. Select [3 STC RANGE].
13. Set the distance for STC effectiveness, then press the **ENTER MARK** key. A higher setting eliminates farther surface reflections.
14. If necessary, select [4 LOW LEVEL ECHO] to reject low level echoes. The higher the figure, the stronger the low level echo that is erased.
15. Select [5 NEAR STC CURVE].
16. Select the appropriate setting for close-range sea conditions.
17. Select [5 NEAR STC RANGE].
18. Select the range to which you want to apply the [NEAR STC CURVE] settings.
19. Select [1 BACK] to show the second page of the [CUSTOMIZED ECHO] menu.
20. To save custom settings, select [SAVE] from [3 DEFAULT].

Note: For C-types, when customized settings are not saved, the “save” floppy disc icon appears. You can click the icon to save the customized settings.



21. Close the menu.

1.28.3 How to restore a user customized echo to the saved settings

If you get lost in operation while changing the settings for a user customized echo, you can easily restore the settings for that user customized echo saved at section 1.28.2.

1. Open the menu.
2. Select [1 ECHO].
3. Select [2 CUSTOMIZED ECHO].
4. Select [0 NEXT] to show the next menu page.
5. Select [3 DEFAULT].
6. Select [USER].
7. Close the menu.

1.28.4 How to restore a user customized echo to the factory default settings

You can restore customized echo options to their factory default settings (see the tables on page 1-56 for a list of the default settings).

1. Open the menu.
2. Select [1 ECHO].
3. Select [2 CUSTOMIZED ECHO].
4. Select [0 NEXT] to show the next menu page.
5. Select [3 DEFAULT].
6. Select [FACTORY], then press the **ENTER MARK** key.
7. Close the menu.

1.28.5 How to edit the available customized echoes

To edit which customizations are available from the [CUSTOMIZE ECHO] box, follow the procedure below.

1. Open the menu.
2. Select [1 ECHO].
3. Select [0 NEXT].
4. Select [3 SELECT CUSTOM]. The [SELECT CUSTOM] menu appears.

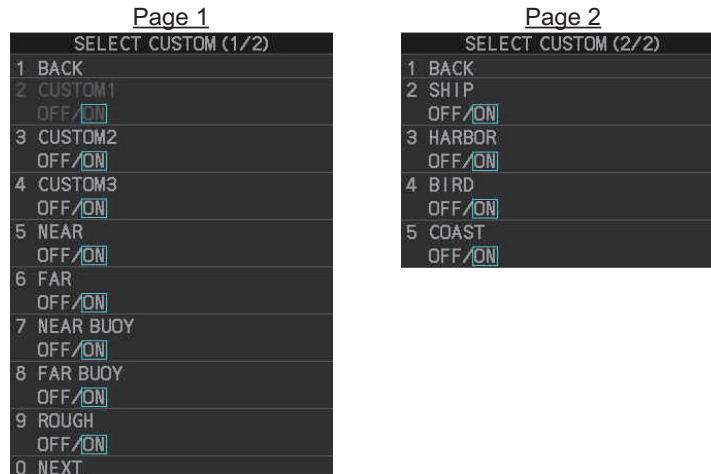

5. Select the customization you want to edit.
The customizations are listed over two menu pages. Select [0 NEXT] to see the next page, or select [1 BACK] to return to the previous menu page.
6. Select [ON] to make the customization available from the [CUSTOMIZE ECHO] box, or select [OFF] to hide the customization from the [CUSTOMIZE ECHO] box.
Note: The factory default setting for all items in this menu is [ON].
7. Close the menu.

1.28.6 How to change the name of a customization (C-types only)

1. Open the menu.
2. Select [1 ECHO].
3. Select [2 CUSTOMIZED ECHO].
4. Select [0 NEXT] to show the next menu page.



5. Select [5 CUSTOMIZED ECHO NAME]. The software keyboard window appears.
6. Referring to section 1.5.3, change the name of the customization.
7. Close the menu.

1.28.7 How to link the customization with a range (C-types only)

You can set link your customized presets with a specified range to save time. Linked settings are changeable and are also applied if the range is changed while in stand-by mode.

To link customized settings with a range, do the following:

1. Open the menu.
2. Select [1 ECHO].
3. Select [0 NEXT].
4. Select [8 CUSTOM LINK].
5. Select [LINK RANGE].
6. Select [SET CUSTOM LINK]. Linked customizations appear next to their linked range in the [SET CUSTOM LINK] menu. The default setting for all ranges is [CUSTOM 1].

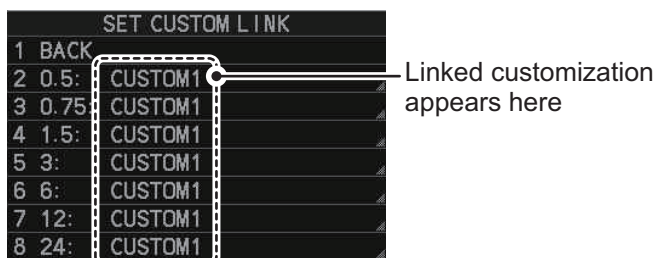

- [0.5]: links the customization to 0.5NM/SM/km/kyd range or lower
 - [0.75]: links the customization to ranges between 0.75 and 1NM/SM/km/kyd
 - [1.5]: links the customization to ranges between 0.175 and 1NM/SM/km/kyd
 - [3]: links the customization to ranges between 3 and 4NM/SM/km/kyd
 - [6]: links the customization to ranges between 6 and 8NM/SM/km/kyd
 - [12]: links the customization to ranges between 12 and 16NM/SM/km/kyd
 - [24]: links the customization to 24NM/SM/km/kyd range or higher
7. Select the range you want to link a customization to. The available options appear.

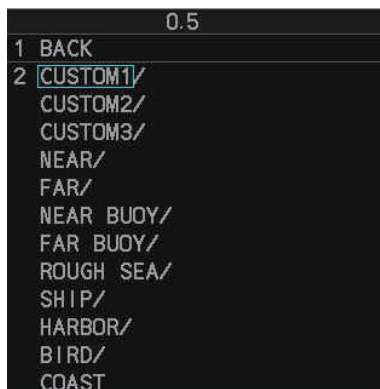

Note: If the name of a customization is changed (see section 1.28.6), the custom name appears instead of the default.

8. Select the customization you want to link to the selected range.
9. Repeat steps 7 and 8 to link other ranges and customizations.
10. Close the menu.

1.29 How to Reject Second-trace Echoes

In certain situations, echoes from very distance targets can appear as false echoes (second-trace echoes) on the screen. This occurs when the return echo is received one transmission cycle later, or after a next radar pulse has been transmitted.

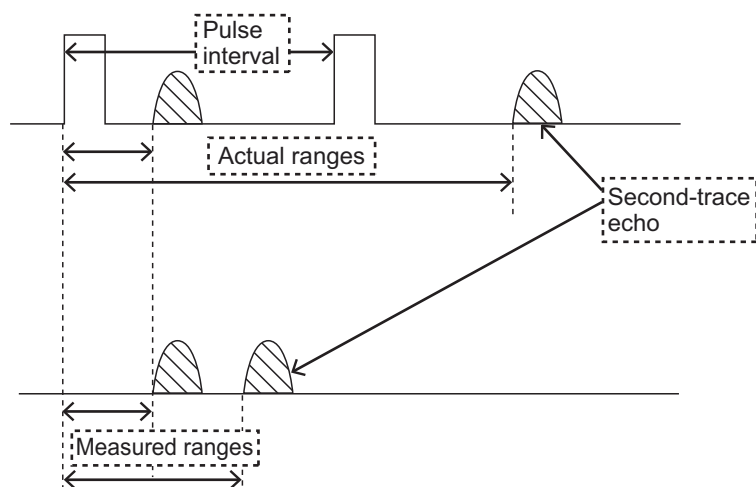

This equipment lengthens the pulse repetition period to reject false echoes.

Note 1: This function decreases the number of echo hits. Use this function carefully so that the possibility of detecting small targets and high-speed craft does not lessen.

Note 2: This function is not available on FAR-2x58 monitors which are assigned as [SUB] at installation.

To reject second trace echoes, do the following:

1. Open the menu.
2. Select [1 ECHO].
3. Select [3 2ND ECHO REJ].
4. Select [ON], then press the **ENTER MARK** key. Select [OFF] to disable rejection.
5. Close the menu.

1.30 Orientation Modes

This radar has the following orientation modes available:

Mode	Description
Relative Motion (RM) modes	
[HEAD UP RM]	Not stabilized
[STERN UP RM]*	The radar image is rotated 180°. Graphics and relative and true bearings are also rotated 180°.
[STAB HEAD UP RM]	Head-up with compass bearing scale (True Bearing) where the bearing scale rotates with the compass reading.
[COURSE UP RM]	Compass-stabilized relative to ship's orientation at the time of selecting COURSE UP.
[NORTH UP RM]	Compass-stabilized with reference to North.
True Motion (TM) modes	
[NORTH UP TM]	Land objects and sea are stationary. Requires compass and speed data.
*: [STERN UP RM] is only available for C-types.	

1.30.1 How to select an presentation mode

Select the [ORIENTATION MODE] box at the top left corner of the screen, then left-click to cycle through the available orientation modes.



Loss of gyrocompass signal

When the compass signal is lost, "NO GYRO SIGNAL" appears in yellow-orange in the [ALERT] box, the orientation mode automatically becomes HEAD UP, and TT and AIS targets, map and chart are erased. Stop the alert with the **ALARM ACK** (RCU-014) or **ALERT ACK** (RCU-031) key or left-click the [ALERT] box. Check the GYRO data.

1.30.2 Description of presentation modes

HEAD UP mode

A display without azimuth stabilization in which the line that connects the center with the top of the display indicates your heading. Targets are shown at their measured distances and their directions relative to your heading. The short dotted line on the bearing scale is the north marker.

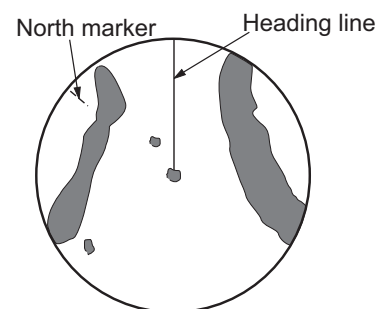

Note: For C-types, you can make the following adjustment in the menu to show smoother echoes when turning at high speeds. However, with this adjustment, the [WIPER] and [ZOOM] functions are disabled. Set [TRUE VIEW] to [ON] on the second page of the [ECHO] menu.

COURSE UP mode

The radar picture is stabilized and displayed with the currently selected course at the top of the screen. When you change the heading, the heading line moves with the course selected. If you select a new course, select the course up mode again to display the new course at the top of the display. Targets are shown at their measured distances and their directions relative to the set course, which is at the 0-degree position. The heading line moves according to the yawing and any course change.

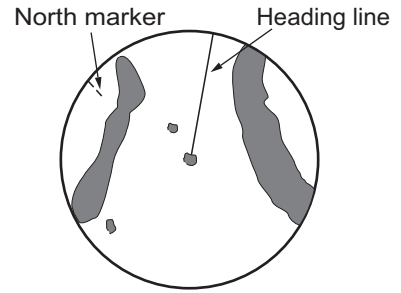

NORTH UP mode

Targets are shown at their measured distances and their true (compass) directions from your ship. North is at the top of the screen. The heading line changes its direction according to your heading.

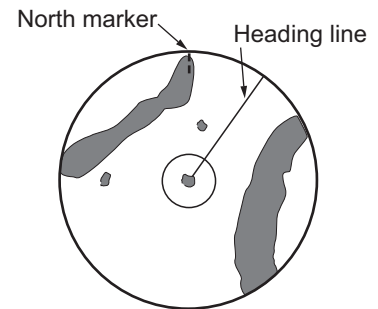

STAB HEAD UP mode

Radar echoes are shown in the same way as in the HEAD UP mode. The difference from normal HEAD UP presentation lies in the orientation of the bearing scale. The bearing scale is heading sensor stabilized. That is, it rotates in accordance with the heading sensor signal, enabling you to know own ship's heading at a glance.

This mode is available when the radar is interfaced with a gyrocompass. If the gyrocompass fails, the bearing scale returns to the state of HEAD UP mode.

True motion mode

Your ship and other objects in motion move with their true courses and speed. All fixed targets, like landmasses, appear as fixed echoes in ground stabilized TM. When your ship reaches a point that is 50% of the radius of the display, the position is reset. The ship appears at 75% radius opposite to the extension of the current course. You can manually reset your ship symbol if you press the **5 CU/TM RESET** key.

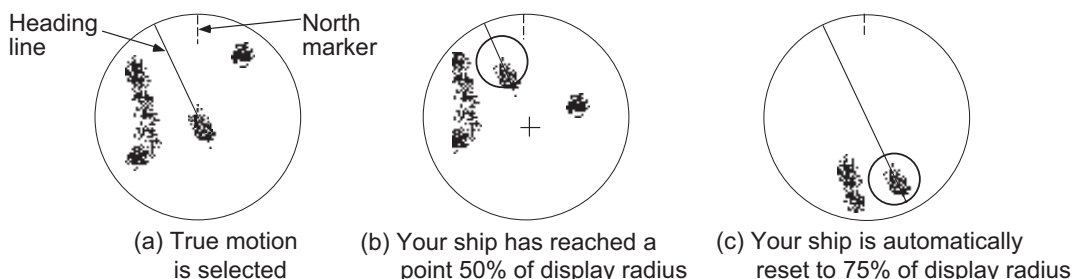

Note: The position of the own ship marker and bearing scale change according to reference position and off-centering.

- ANT: When OFF CENTER is active, the bearing scale intervals change accordingly.
- CCRP: When the CCRP moves outside the operational display area, the bearing scale intervals may not be displayed correctly.

STERN UP mode

The STERN UP mode rotates the HEAD UP mode picture, relative and true bearings and display graphics 180°. This mode is useful on dual-radar tugboats when backing up; one radar shows HEAD UP and another shows STERN UP. To enable the STERN UP mode, turn on [STERN UP] on the [OPERATION] menu.

Note: STERN UP mode is only available for C-types.

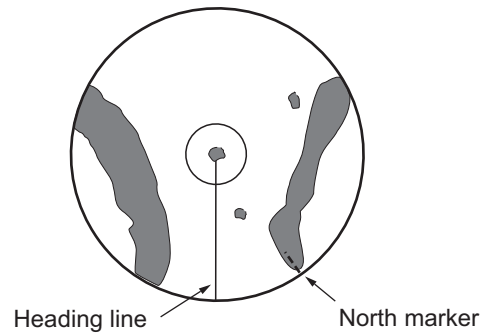

1.31 How to Select a Range Scale

The selected range scale and range ring interval are shown at the upper left corner on the screen. When a target of interest comes closer, reduce the range scale so that it appears in 50-90% of the display radius.

1. Place the cursor in the [RANGE] box at the top left corner of the screen.

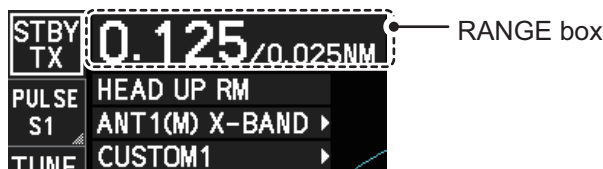

In the above example, the range scale is set to 0.125 NM and the interval between range rings is set to 0.025 NM.

2. Left-click to lower the range; right-click to raise the range.

You can also select the range with the **RANGE** key on the control unit (not available for RCU-015/RCU-016). Press "+" to increase the range, or press "-" to reduce the range. Press and hold a key to successively change the range upwards or downwards.

Changing the plotter range (C-types only)

With the radar in standby (STBY) mode, you can change the plotter range by pressing the **RANGE** key. In this case, "range" means the on-screen displayed distance from the left-hand edge of the screen to the right-hand edge of the screen.

"+": expands the range scale with the cursor location as the center.

"-": reduces the range scale with the cursor location as the center.

Press and hold the + or - key to change the range scale continuously.

1.32 How to Measure Range

The range to a target can be measured three ways: with the fixed range rings, with the cursor, or with the VRM.

Use the fixed range rings to get an estimate of the range to a target. The rings are the concentric solid circles on the display. The number of rings is automatically set by the current range scale. The distance between the rings is the range ring interval, and the current interval appears at the upper-left position on the screen. To measure the range to a target with the range rings, count the number of rings between the center of the display and the target. Check the range ring interval and estimate the distance of the echo from the inner edge of the nearest ring.

1.32.1 How to show/hide the range rings

1. Open the menu.
2. **For IMO-types**, select [3 NAV TOOLS] to show the [NAV TOOLS] menu.
For C-types, select [3 CURSOR•EBL•VRM] to show the [CURSOR•EBL•VRM] menu.
3. **For IMO-types**, select [4 RANGE RINGS].
For C-types, select [6 RANGE RINGS].
4. Depending on your radar type, select the appropriate setting.
For IMO-types: Select [ON] or [OFF] as appropriate.
For C-types: Select the appropriate setting, referring to the following list.
 - [OFF]: Hide the range rings.
 - [STD]: Range rings increase/decrease in number, according to the selected radar range.
 - [MANUAL]: Set a number of range rings that are not linked with the radar range.
5. Close the menu.

1.32.2 How to measure range with the variable range marker (VRM)

There are two VRMs, No. 1 and No. 2, which appear as dashed rings so that you can distinguish them from the fixed range rings. The two VRMs can be distinguished from each other by the different lengths of their dashes; the dashes on the No. 2 VRM are longer.

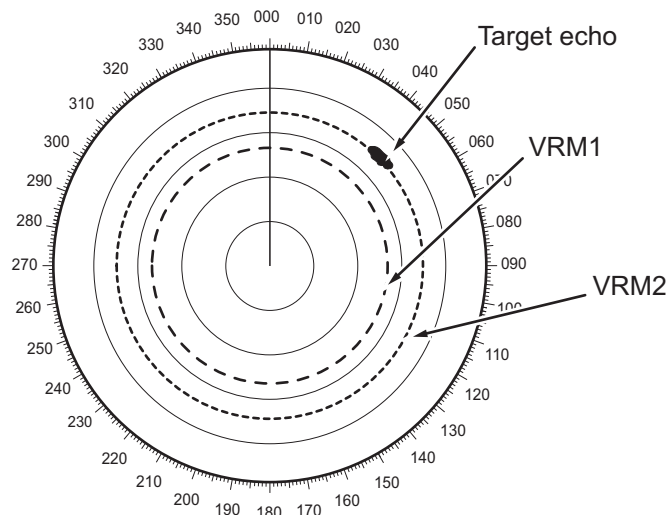

1. OPERATIONAL OVERVIEW

There are two methods for measuring range with the VRMs, using the **VRM** key and on-screen menu box operation.

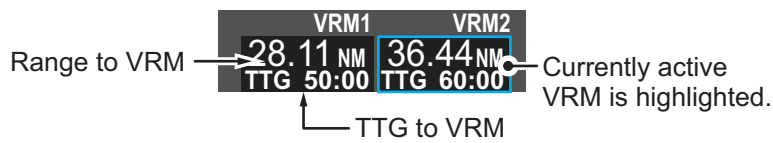

Note: You can hide the [TTG] indication.
See section 1.32.5.

Using the VRM keys on the control unit (RCU-014/RCU-031)

1. Press the **VRM ON** key to activate the VRM1 box. Press the **VRM ON** key again to activate the VRM2 box. Press the **VRM ON** key again to switch between active VRMs. The currently active VRM marker is displayed as shown in the above figure.
2. Rotate the **VRM** knob to align the active VRM with the inner edge of the target, then read the distance at the lower right of the screen. In the above figure, the active VRM reads "36.44 NM".
Each VRM remains at the same geographical distance when you operate the **RANGE** key or the [RANGE] box. This means that the apparent radius of the VRM ring changes in proportion to the selected range scale.
3. Press the **VRM OFF** key to hide the VRMs.

On-screen menu box operation

1. Select the appropriate [VRM] box.
2. The guidance box reads "VRM ON/".
Left-click to turn on the VRM.
The guidance box now reads "VRM SET L = DELETE /".
Further, the box is highlighted and the corresponding VRM appears.
3. Left-click again and the cursor jumps to inside the operational display area. The guidance box now reads "VRM FIX L = DELETE / EXIT".
4. Move the trackball to adjust the VRM.
Note: The maximum VRM distance is set by the current display range and can be set as high as twice the distance of the display range.
5. Left-click to anchor the VRM and fix its readout, or right-click to cancel and return the VRM to its previous location (range).
6. To hide the VRM, left-click the [VRM] box to show "VRM SET L = DELETE /" in the guidance box, then press and hold the **left button** on the trackball.

1.32.3 How to set the VRM unit of measurement (C-types only)

VRMs can be displayed in the following units of measurement:

- NM (Nautical Miles)
- SM (Statute Miles)
- km (Kilometers)
- kyd (Kiloyards)

To change the unit of measurement, do the following:

1. Open the menu.
2. Select [3 CURSOR•EBL•VRM].
3. Select [3 EBL•VRM].
The [EBL•VRM] menu appears.
4. Select [VRM1] or [VRM2] as appropriate.
5. Select the required unit of measurement.
6. Close the menu.

Note: Changes made to the measurement units also affect the active VRMs.



1.32.4 How to set the short distance measurement unit (C-types only)

You can set a different unit of measurement to use within a pre-determined range from your vessel. This setting affects the VRM indication as well as the cursor indication.

1. Open the menu.
2. Select [3 CURSOR•EBL•VRM].
The [CURSOR•EBL•VRM] menu appears.
3. Select [8 SHORT DISTANCE UNIT].
4. Select the unit to want to use for short distances, or select OFF to disable this feature.
5. Select [9 DIST UNIT CHANGEOVER].
6. Spin the scrollwheel, or enter the distance using the control unit.
Echoes selected within this distance (range) from your vessel have their distance shown with the selected measurement unit.
7. Close the menu.

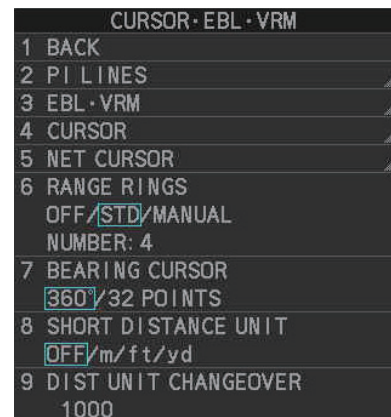

1.32.5 How to show TTG to VRM

TTG (Time To Go) to a selected VRM can be displayed as follows:

1. Open the menu.
2. **For IMO-types**, select [3 NAV TOOLS] to show the [NAV TOOLS] menu.
For C-types, select [3 CURSOR•EBL•VRM] to show the [CURSOR•EBL•VRM] menu.
3. **For IMO-types**, select [3 EBL•VRM•CURSOR SET].
For C-types, select [3 EBL•VRM].
4. **For IMO-types**, select [3 VRM TTG.]
For C-types, select [7 VRM TTG.]
5. Select the appropriate setting.
 - [OFF]: TTG is not displayed.
 - [1]: TTG from own ship to VRM 1 only is displayed.
 - [2]: TTG from own ship to VRM 2 only is displayed.
 - [1and2]: TTG from own ship to both VRMs is displayed.
6. Close the menu.

1.33 How to Measure Bearing

The Electronic Bearing Lines (EBLs) are used to take bearings of targets. There are two EBLs, EBL1 and EBL2. Each EBL is a straight dashed line extending out from the own ship position up to the circumference of the radar picture. The two EBLs can be distinguished from each other by the different lengths of their dashes; the dashes on EBL2 are longer.

Each EBL has an EBRL (Electronic Bearing Range Line, indicated as a short line, crossing the EBL at right angles). When VRM is not displayed and only EBL is displayed, the EBRL shows the range from the EBL origin.

When VRMs are displayed with EBLs the VRM overlaps the EBRL. The value for EBRL and VRM is the same and is displayed in the VRM box at the bottom-right of the screen.

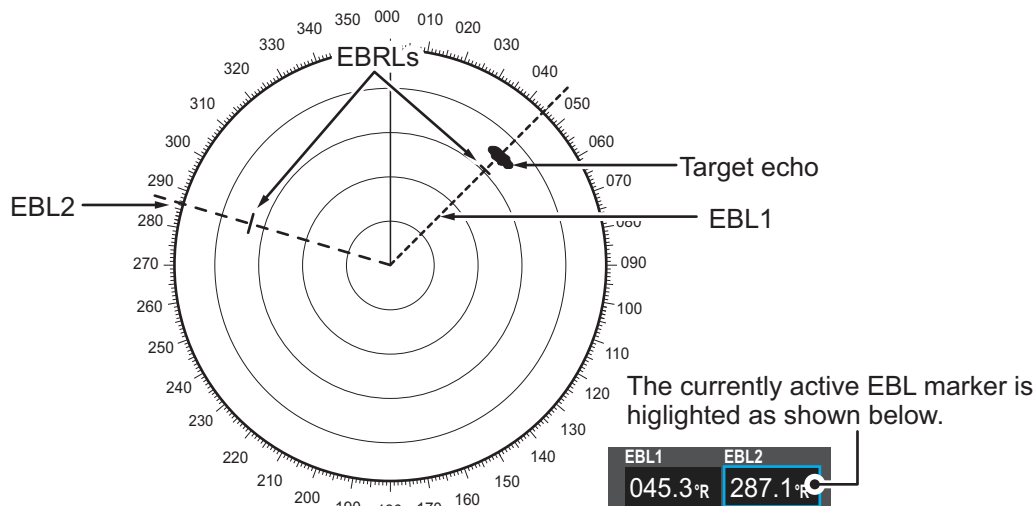

1.33.1 Methods to measure bearing

There are two methods for measuring bearing, using the **EBL** key and on-screen menu box operation.

Using the EBL keys on the control unit (RCU-014/RCU-031)

1. Press the **EBL ON** key to activate the [EBL1] box. Press the **EBL ON** key again to activate the EBL2 box. Press the **EBL ON** key again to switch between active VRMs.
2. Rotate the **EBL** knob clockwise or counterclockwise until the active EBL bisects the target of interest, then read its bearing at the lower-left corner of the screen.
3. Press the **EBL OFF** key to erase the active EBL.

On-screen menu box operation

1. Select the appropriate EBL box.
2. The guidance box reads "EBL ON/". Press the **left button** to turn on the EBL. The guidance box now reads "EBL SET L=DELETE /".
3. Press the **left button** again and the cursor jumps to inside the operational display area. The guidance box now reads "EBL FIX L=DELETE/".
4. Rotate the **EBL** knob clockwise or counterclockwise until the active EBL bisects the target of interest. Read the bearing at the lower-left corner of the screen.
5. To erase the EBL(s), place the cursor on the box for the EBL you want to erase, then press and hold the **left button**.

1.33.2 True or relative bearing

The EBL readout is affixed by "R" (relative) if it is relative to own ship's heading, "T" (true) if it is referenced to the north. True or relative indication is available regardless of presentation mode.

1. Open the menu.
2. **For IMO-types**, select [3 NAV TOOLS].
For C-types, select [3 CURSOR•EBL•VRM].
3. **For IMO-types**, select [3 EBL•VRM•CURSOR SET].
For C-types, select [3 EBL•VRM].
4. **For IMO-types**, select [5 EBL•CURSOR BEARING].
For C-types, select [2 EBL1] or [3 EBL2] as appropriate.
5. Select the [REL] or [TRUE] as required, then press the **ENTER MARK** key.
6. Close the menu.

Note: The EBL and its indication change according to gyrocompass changes as follows:

Gyro heading	EBL changes
HEAD UP / relative	EBL indication and EBL marker are unchanged.
HEAD UP / true	EBL indication does not change, however the EBL marker moves accordingly
COURSE UP / relative	EBL indication does not change, however the EBL marker moves accordingly.
COURSE UP / true	EBL indication and EBL marker are unchanged.
NORTH UP / relative	EBL indication does not change, however the EBL marker moves accordingly
NORTH UP / true	EBL indication and EBL marker are unchanged.

1.34 Collision Assessment by Offset EBL

The origin of the EBL can be placed anywhere to enable measurement of range and bearing between any two targets. This function is also useful for assessment of the potential risk of collision. It is possible to read CPA (Closest Point of Approach) by using the EBL range marker as shown in (a) in the illustration below. If the EBL passes through the sweep origin (own ship) as shown in (b) in the illustration below, the target ship is on a collision course.

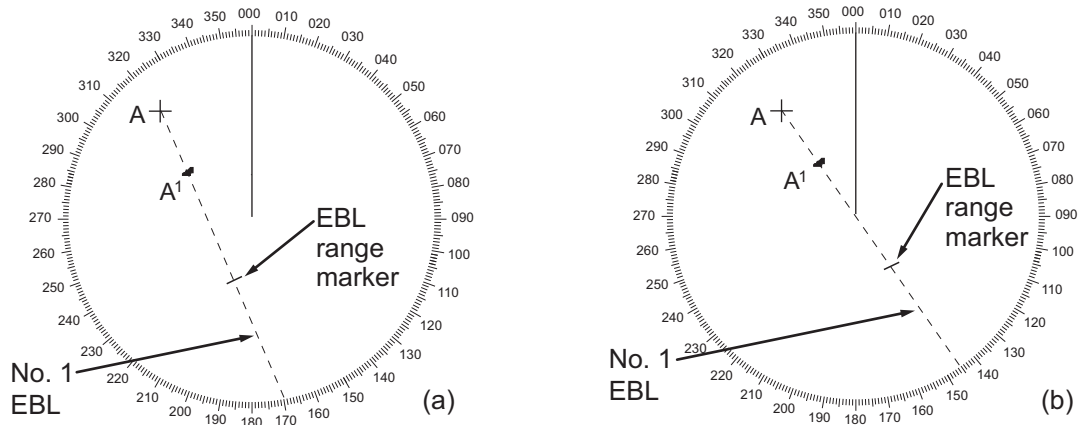

1.34.1 How to assess risk of collision using the offset EBL

There are two methods for assessing risk collision. You can use the control unit or the [CURSOR] menu.

Using the control unit (RCU-014/RCU-031)

1. Press the **EBL ON** key to display or activate an EBL (EBL1 or EBL2).
2. Place the cursor on a target appearing as threatening (indicated as "A" in the example figure on the previous page).
3. Press the **EBL OFFSET** key and the origin of the active EBL shifts to the cursor position.
4. Press the **EBL OFFSET** key again to anchor the EBL origin.
5. After waiting for a few minutes (at least 3 minutes), operate the **EBL** knob until the EBL bisects the target at the new position (A¹). The EBL readout shows the target ship's course, which can be true or relative depending on the EBL bearing reference setting.

Note: If relative motion is selected, it is also possible to read CPA by using the range marker as shown in left-hand figure at the top of the next page. If the EBL passes through the sweep origin (own ship) as illustrated in the right-hand figure above, the target ship is on a collision course.

6. To return the EBL origin to the own ship's position, then press the **EBL OFFSET** key.

1. OPERATIONAL OVERVIEW

Using the on-screen box

1. Select the operational display area, then right-click. The [CURSOR] context menu appears.
2. Select [EBL OFFSET].
3. Select the operational display area, then left-click. The EBL line is attached to the cursor.
4. Place the offset EBL on the target appearing as threatening, then left-click.
5. After waiting for a few minutes (at least 3 minutes), operate the EBL used in step 4 until it bisects the target at the new position (A¹). The EBL readout shows the target ship's course, which can be true or relative depending on the EBL bearing reference setting.
6. To return the EBL origin to the own ship's position, repeat steps 1 to 3.
7. Close the menu.

1.34.2 How to set the origin point reference for EBL OFFSET

The origin point of the offset EBL can be ground stabilized (geographically fixed), north stabilized (true) or referenced to own ship's heading (relative).

1. Open the menu.
2. **For IMO-types**, select [3 NAV TOOLS].
For C-types, select [3 CURSOR•EBL•VRM].
3. **For IMO-types**, select [3 EBL•VRM•CURSOR SET].
For C-types, select [3 EBL•VRM].
4. **For IMO-types**, select [2 EBL OFFSET BASE].
For C-types, select [6 EBL OFFSET BASE].
5. Select [STAB GND], [STAB HDG] or [STAB NORTH] as appropriate, then press the **ENTER MARK** key.
 - [STAB GND]: Reference to latitude and longitude. Origin position is always fixed regardless of your ship's movement.
 - [STAB HDG]: Reference to heading. The relationship between origin position and own position is kept always.
 - [STAB NORTH]: Reference to North. The origin position changes with North position.
6. Close the menu.

1.35 How to Measure Range and Bearing Between Two Targets

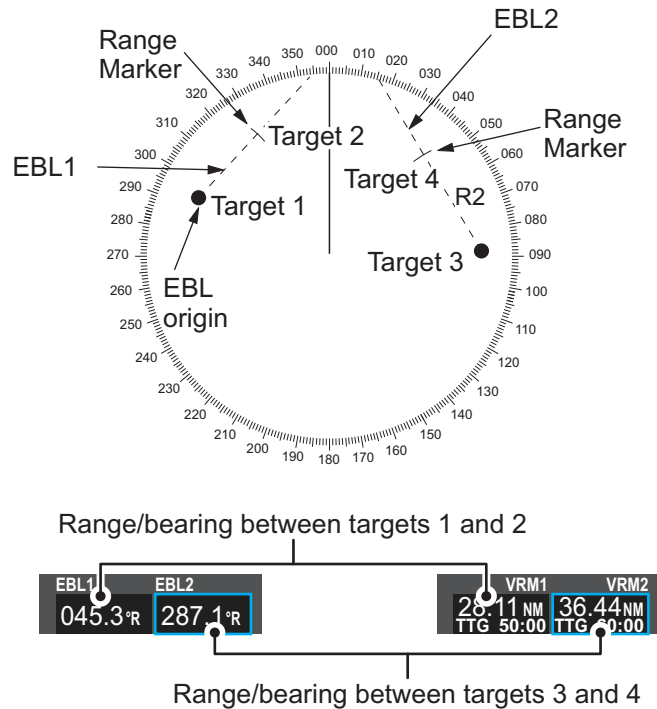

How to measure range and bearing from the [CURSOR] menu

This procedure uses EBL1 and VRM1 as an example and is written on the premise that neither of the EBLs or VRMs is active.

1. Place the cursor on the EBL1 box, then left-click. EBL1 is now active.
2. Place the cursor inside the operational display area, then right-click to show the [CURSOR] context menu.
3. Select [EBL OFFSET]. The cursor is displayed with a red surround, indicating that the [EBL OFFSET] mode is now active.
4. With the cursor in the operational display area, left-click. EBL1 moves to the cursor location.
5. Place the offset EBL on the target of interest (Target 1), then left-click.
6. Right-click to deactivate the [EBL OFFSET] mode. The red surround on the cursor disappears.
7. Place the cursor on the [EBL1] box, then spin the scrollwheel until EBL1 intersects the secondary target (Target 2 in the example figure).
8. Place the cursor on the [VRM1] box, then spin the scrollwheel until the range marker on EBL1 aligns with Target 2. The readouts for EBL1 and VRM1, at the bottom of the screen, indicate the bearing and range between the Target 1 and Target 2.
9. You can repeat the same procedure on third and fourth targets (shown as "Target 3" and "Target 4" in the above example) by using EBL2 and VRM2.

Bearing is shown relative to own ship with suffix "R" or as a true bearing with suffix "T" depending on EBL relative/true settings in the [EBL•VRM•CURSOR SET] menu.

How to measure range and bearing from the control unit (RCU-014/RCU-031)

Range and bearing can be measure using the **EBL OFFSET** key.

1. Press the **EBL ON** key to activate EBL1.
2. Place the cursor inside the operational display area, then press the **EBL OFFSET** key. EBL1 moves to the cursor.
3. Place the cursor (EBL1 moves with the cursor) on a target of interest. (Shown as "Target 1" in the above example), then press the **EBL OFFSET** key.
4. Rotate the **EBL** knob to move the EBL until it passes through another target of interest. (Shown as "Target 2" in the above example).
5. Place the cursor on the [VRM1] box.
6. Rotate the **VRM** knob until the range marker on the EBL is on the inside edge of Target 2. The readouts for EBL1 and VRM1, at the bottom of the screen, indicate the bearing and range between the Target 1 and Target 2.
7. You can repeat the same procedure on third and fourth targets (shown as "Target 3" and "Target 4" in the above example) by using the No. 2 EBL and the No. 2 VRM.

Bearing is shown relative to own ship with suffix "R" or as a true bearing with suffix "T" depending on EBL relative/true settings in the [EBL•VRM] menu.

How to reset the EBL origin to the center of the screen

1. Place the cursor on the box for the EBL to reset, then left-click. The selected EBL is now active and highlighted.
2. Place the cursor inside the operational display area, then right-click. The [CURSOR] context menu appears.
3. Select [EBL OFFSET]. The cursor is now displayed with a red surround.
4. Left-click to return the EBL to the center of the display.
5. Right-click to deactivate the [EBL OFFSET] mode. The red surround on the cursor disappears.

How to link EBL and VRM OFFSET

You can link the EBL and VRM offset to show the VRM range ring with one target as the center-point. This may be helpful if the range marker on the EBL is difficult to see.

1. Open the menu.
2. **For IMO-types**, select [3 NAV TOOLS].
For C-types, select [3 CURSOR•EBL•VRM].
3. **For IMO-types**, select [3 EBL•VRM•CURSOR SET].
For C-types, select [3 EBL•VRM].
4. **For IMO-types**, select [4 VRM OFFSET].
For C-types, select [8 VRM OFFSET].
5. Select [LINK EBL] to link the offset EBL is now displayed with the VRM range ring, as indicated in the figure below.

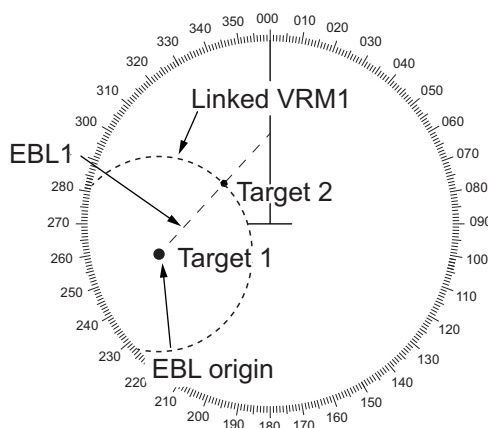

Select [OFF] to deactivate the link between the offset EBL and the VRM.

6. Close the menu.

1.36 How to Off-Center the Display

Own ship position, or sweep origin, can be displaced to expand the view field without switching to a larger range scale. The sweep origin can be off-centered to the cursor position, but not more than 75% of the range in use; if the cursor is set beyond 75% of the range scale, the sweep origin will be off-centered to the point of 75% of the limit.

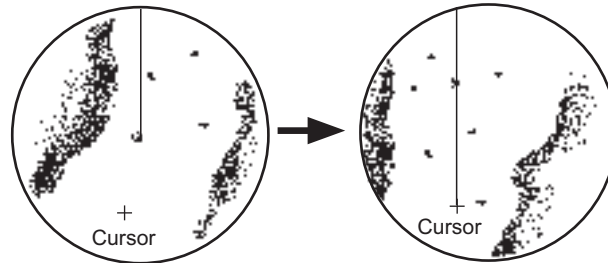

Put cursor where desired and do appropriate off-center procedure.

Off-centered display

This feature is available between 0.215 M and 48 NM ranges. The feature is not available in true motion mode.

If the conning position is outside the effective radar display, some parts of the bearing scale are not shown. For details, see section 1.51.

Note: When the conditions shown below are met, off-center cannot be canceled. This is because the radar antenna position is located at a position greater than 75% of the effective radar display.

- Own ship marker is large.
- The distance between antenna position and conning position is large.
- Short-distance display range.

To cancel the off-center in these cases, select a larger range, then cancel the off-center.

1.36.1 How to off-center the display from the control unit (RCU-014/RCU-031)

With the cursor shown

1. Place the cursor at the position where you wish to move the sweep origin.
2. Press the **OFF CENTER** key. The sweep origin is now off-centered at the cursor position.
3. To cancel off-centering, press the **OFF CENTER** key again.

With the cursor hidden

Use the trackball to move the center to the desired location. To cancel off-centering, press the **OFF CENTER** key.

The location to which the sweep origin returns depends on the following conditions:

- With the radar in transmit mode, or with the radar in standby mode while off-centering is not active: the sweep origin is returned to the center of the screen.
- With the radar in standby mode while off-centering is active: the sweep origin is returned to the off-center position.

1.36.2 How to off-center the display from the on-screen menu

1. Place the cursor inside the operational display area, then right-click to show the [CURSOR] menu.
2. Select [OFF CENTER]. The cursor is now displayed with a red surround, indicating that [OFF CENTER] mode is active.
3. Move the cursor to the position where you wish to move the sweep origin, then left click. The display is now centered at the cursor position.
Note: If you need to move off-center position, you can reset the off-center while the cursor is displayed with the red surround by left-clicking the operational display area.
4. Right-click to cancel [OFF CENTER] mode.
5. To reset the sweep origin to the center of the operational display area, repeat steps 1 to 2, then left-click the operational display area.

1.37 Target Trails

The trails of the radar echoes of targets can be displayed in the form of synthetic afterglow. Target trails are shown either relative or true and can be sea or ground stabilized. True motion trails require a compass signal, and position and speed data. When the range is changed, trails are continued for targets which were already displayed in the previous range. Newly detected targets have no trail when first detected.

1.37.1 True or relative trails

You can display echo trails in true or relative motion. Relative trails show relative movements between targets and own ship. True motion trails present true target movements in accordance with their over-the-ground speeds and courses.

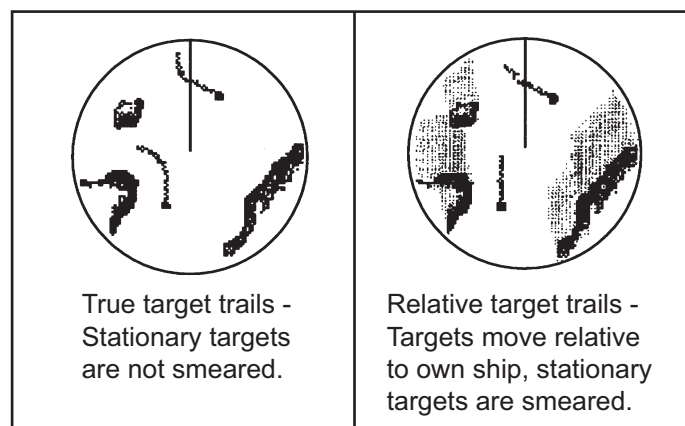

Note: The indication in the [TRAIL MODE] box changes color based on the trail mode and orientation, as shown in the following table.

Trail mode	Orientation	Color
True trails (TRUE-G or TRUE-S)	HEAD UP (relative)	Yellow
	STERN UP (relative)	
	CURSOR GYRO (relative)	White
	COURSE UP (relative)	
	NORTH UP (relative)	

1. OPERATIONAL OVERVIEW

The reference for the past position displays for AIS and TT is also switched whenever the trail reference is switched.

1. Open the menu.
2. Select [1 ECHO].
3. Select [0 NEXT] to show the next menu page.
4. Select [4 TRAILS]. The [TRAIL MENU] appears.

Note: You can also right-click the [TRAIL] box to access this menu.

The diagram illustrates the process of accessing the TRAILS menu. On the left, a menu is shown with the following items: VECTOR (30min, REL), CPA/TCPA (0.5NM, 1min), AIS CPA (OFF), LOST TGT (OFF), PAST POSN (OFF), and TRAIL (OFF, TRUE-G). The TRAIL item is highlighted with a yellow background. Below this menu, three callouts point to the TRAIL box, the TRAIL time (30min), and the TRAIL mode indication (REL). A large black arrow points from the TRAIL box to the TRAILS (1/2) menu on the right. Above the arrow, text reads: "Right-click the [TRAIL] box to show the [TRAILS] menu." The TRAILS (1/2) menu is shown with the following items: 1 BACK, 2 TRAIL MODE (REL/TRUE), 3 TRAIL GRADATION (SINGLE/MULTI/5STEP), 4 TRAIL COLOR (GRN/BLU/CYA/MAG/WHT/YEL), 5 TRAIL LEVEL (1/2/3/4), 6 OS TRAIL (OFF/ON), 7 SUPPRESS AROUND OS (OFF/ON), 8 NARROW TRAIL (OFF/1/2), and 0 NEXT.

5. Select [TRAIL MODE].
6. Select the appropriate trail mode, then press the **ENTER MARK** key.
 - [REL]: Relative target trails. Targets move relative to own ship and stationary targets appear smeared.
 - [TRUE]: True target trails. Targets true movements are shown, stationary targets are not smeared.
7. Close the menu.

You can also click the trail mode indication to toggle between relative and true trails.

1.37.2 Trail time

Trail time is the interval at which the trail is plotted on-screen.

Note: If the trail time is linked with the range (see section 1.9), the trail time is also automatically regulated to show a constant trail. Further, the trail time indication appears in yellow color. To link the trail time with the range, select [NORMAL] in the following procedures; range link is not available if a setting other than [NORMAL] is selected. Also, when using a range that is valid only when in stand-by mode, the trail time is automatically adjusted to match either the maximum or minimum range available in transmit mode.

You can change the trail time as follows:

Using the control unit (RCU-014/RCU-031)

- Press the **CANCEL TRAILS** key to cycle through and select the desired setting.
For IMO-types, the cyclic order is as follows:
 [OFF] → [15 sec] → [30 sec] → [1 min] → [3 min] → [6min] → [15 min] → [30 min] → [CONT] → [OFF]...
For C-types, the available options depend on the setting for [TRAIL LENGTH] in the [TRAILS] section of [ECHO] menu. To set the [TRAIL LENGTH] time, see section 1.37.12.

[TRAIL LENGTH] setting	Available options
[NORMAL]	[OFF], [15 sec], [30 sec], [1 min], [3 min], [6 min], [15 min], [30 min], [CONT].
[12H]	[OFF], [30 min], [1 hr], [3 hr], [6 hr], [12 hr], [CONT].
[24H]	[OFF], [1 hr], [2 hr], [3 hr], [6 hr], [12 hr], [18 hr], [24 h], [CONT].
[48H]	[OFF], [2 hr], [4 hr], [8 hr], [16 hr], [24 hr], [36 hr], [48 h], [CONT].

Using the on-screen box

- Place the cursor on the trail time setting inside the [TRAIL] box, at the bottom-right of the screen.
- Left-click the [TRAIL] box to change the trail time.
For IMO-types, the cyclic order is as follows: [OFF] → [15 sec] → [30 sec] → [1 min] → [3 min] → [6min] → [15 min] → [30 min] → [CONT] → [OFF]...
For C-types, the available options depend on the setting for [TRAIL LENGTH] in the [TRAILS] section of [ECHO] menu. To set the [TRAIL LENGTH] time, see section 1.37.12.

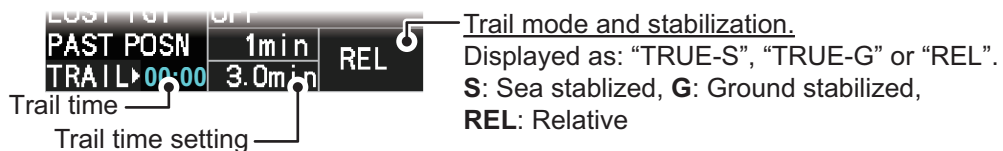

Spin the scrollwheel to change the trail time. The options for each [TRAIL LENGTH] setting are listed the following table.

[TRAIL LENGTH] setting	Available options
[NORMAL]	[OFF], [15 sec], [30 sec], [1 min] to [30 min] at 30-second intervals, [CONT].
[12H]	[OFF], [00:30] to [12:00] at 30 minute intervals, [CONT].
[24H]	[OFF], [00:30] to [24:00] at one hour intervals, [CONT].
[48H]	[OFF], [00:30] to [48:00] at two hour intervals, [CONT].

1. OPERATIONAL OVERVIEW

Note 1: The timer displays the elapsed time of the selected trail. Use caution when using this feature, as the displayed time is not the overall trail time. Also, when the trail timer is displayed, the trail accuracy of other ship's echoes may be lowered. When the trail time reaches the preset interval, the timer disappears.

Note 2: The [CONT] option sets the trail time plotting as continuous. When the plotting time reaches 29:59, the timer is hidden. The timer reappears when [TRAIL ALL CLEAR] is selected, or when the range is changed.

1.37.3 Trail gradation

The trail afterglow can be displayed in a single tone or gradual time-based shading.



1. Open the menu.
2. Select [1 ECHO].
3. Select [0 NEXT] to show the next menu page.
4. Select [4 TRAILS]. The [TRAIL MENU] appears.
5. Select [3 TRAIL GRADATION].
6. Select the appropriate setting, referring to the following list.
 - [SINGLE]: Trails are displayed in monotone.
 - [MULTI]: Trails are displayed in multiple colors, based on time.
 - [5STEP]*: Trails are colored in 5 shades, brightest color for new trails, dullest color for old trails.

*: C-types only.
7. Close the menu.

1.37.4 Trail level

The level, or intensity, of the afterglow that extends from radar targets can be selected as below.

1. Open the menu.
2. Select [1 ECHO].
3. Select [0 NEXT] to show the next menu page.
4. Select [4 TRAILS]. The [TRAIL MENU] appears.
5. Select [5 TRAIL LEVEL].
6. Select the appropriate setting, then press the **ENTER MARK** key. The higher the number, the greater the intensity of the afterglow.
7. Close the menu.

1.37.5 Narrow trails (C-type only)

Target trails can be painted with thinner lines if desired. This csection 1.37.2an be useful when there are a lot of targets on the screen and it is hard to distinguish one from another.

1. Open the menu.
2. Select [1 ECHO].
3. Select [0 NEXT] to show the next menu page.
4. Select [4 TRAILS]. The [TRAIL MENU] appears.
5. Select [8 NARROW TRAIL].
6. Select the appropriate setting from [OFF], [1] or [2], then press the **ENTER MARK** key. A trail with a setting of [2] is thinner than a trail with a setting of [1].
7. Close the menu.

1.37.6 How to hide the trails temporarily

Following the procedure outlined in section 1.37.2, set the trail time to [OFF]. The trails are hidden from view, but are continued. To show the trails again, repeat the procedure, setting the trail time to any interval other than [OFF].

1.37.7 Trail stabilization in true motion

True motion trails can be ground stabilized or sea stabilized. The [TRAIL] box shows current stabilization as "TRUE-G" or "TRUE-S". You can change the stabilization mode with the following procedure.

1. Open the menu.
2. Select [7 INFORMATION BOX].
3. Select [2 OWN SHIP INFO].
4. Select [3 SPEED]. The [SPEED] menu appears.
Note: You can also access the [SPEED] menu from the on-screen box. Place the cursor on the [SPD ►] indication in the speed box at the top-right of the screen, then right-click.
5. Select [2 SHIP SPEED].
6. Select [LOG(BT)] (ground stabilization) or [LOG(WT)] (sea stabilization) as required.
7. Close the menu.

Note: The stabilization mode is applied to own ship speed and TT trails.

1.37.8 How to erase/restart trails

All trails can be erased (including those in the memory) and restarted to start fresh trails. There are three methods you can use to erase trails.

To erase all trails displayed in the operational display area:

- Select the [TRAIL] box, then press and hold the **left button** on the trackball; or
- Press and hold **CANCEL TRAILS** key.

To erase a section of a trail (C-types only):

1. Place the cursor inside the operational display area, then right-click to show the [CURSOR] menu.
2. Select [TRAIL ERASER]. The cursor is now displayed with a red surround and a dashed circle, indicating that [TRAIL ERASER] mode is active.
3. Press the **left button** to change the diameter of the dashed circle, as shown in the figure below.

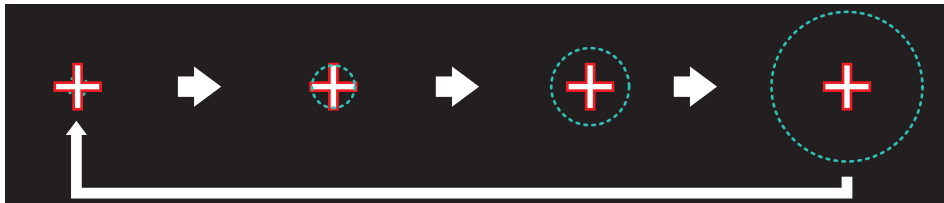

4. Place the cursor on the trail whose section you want to erase, then press and hold the **left button**.
5. With the **left button** pressed, drag the cursor over the section of the trail you want to erase. The section of trail “covered” by the dashed circle is erased.
6. Release the **left button**.
7. Right-click to deactivate the [TRAIL ERASER] function. The cursor is no longer highlighted and the dashed circle disappears.

1.37.9 How to prevent sea clutter in true trails

You can prevent the display of sea clutter in true trails about your ship to clear the radar picture. Your ship's trails can also be shown or hidden.

1. Open the menu.
2. Select [1 ECHO].
3. Select [0 NEXT] to show the next menu page.
4. Select [4 TRAILS]. The [TRAIL MENU] appears.
5. Select [7 SUPPRESS AROUND OS].
6. Select [OFF] or [ON] as appropriate.
Note: For IMO-types, when [6 OS TRAIL] is set to [ON], [7 SUPPRESS TRAILS] is automatically fixed at [ON]. To disable the sea clutter suppression feature, change [6 OS TRAIL] to [OFF], then change the setting for [7 SUPPRESS TRAILS].
7. Close the menu.

1.37.10 How to show/hide OS trails

To show or hide the OS trail at any time, follow the procedure below.

1. Open the menu.
2. Select [1 ECHO].
3. Select [0 NEXT] to show the next menu page.
4. Select [4 TRAILS]. The [TRAIL MENU] appears.
5. Select [6 OS TRAIL].
6. Select [OFF] or [ON] as appropriate.

Note: For IMO-types, when [6 OS TRAIL] is set to [ON], [7 SUPPRESS AROUND OS] is automatically fixed at [ON]. To disable the sea clutter suppression feature, change [6 OS TRAIL] to [OFF], then change the setting for [7 SUPPRESS AROUND OS].

7. Close the menu.

1.37.11 How to show/hide land trails (C-type only)

You can improve the on-screen display visibility by hiding trails generated by land-masses and non-moving objects. Hiding the trails has the following possible benefits:

- Land-masses have no trail, allowing you to use relative trails near coastlines.
- Only moving echoes create a trail, improving target identification.

1. Open the menu.
2. Select [1 ECHO].
3. Select [0 NEXT].
4. Select [4 TRAILS]. The [TRAIL MENU] appears.
5. Select [0 NEXT] to show the second page of the menu.
6. Select [2 HIDE LAND TRAILS(T)] or [3 HIDE LAND TRAILS(R)] as appropriate.
7. Referring to the table below, select the appropriate setting, then press the **ENTER MARK** key.

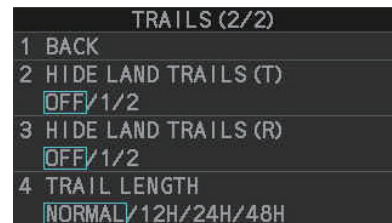

Setting	Trails for non-moving objects		Trails for moving objects
	Large objects	Small objects	
[OFF]	Trails are shown	Trails are shown	Trails are shown
[1]	Trails are hidden	Trails are shown	Trails are shown
[2]	Trails are hidden	Trails are hidden	Trails are shown

8. Close the menu.

Note: When option [1] or [2] is selected trails for echoes outside the displayed area are not generated. It is important to note that, where the displayed area is moved by functions such as off-centering or true motion, newly displayed echoes do not have trails.

1.37.12 How to set the trail length (C-type only)

You can save up to 48 hours of trails. the [TRAIL LENGTH] can be set to one of the following lengths: [NORMAL], [12H], [24H] or [48H]. To set the trail length, follow the procedure below.

1. Open the menu.
2. Select [1 ECHO].
3. Select [0 NEXT].
4. Select [4 TRAILS]. The [TRAIL MENU] appears.
5. Select [0 NEXT] to show the second page of the menu.
6. Select [4 TRAIL LENGTH].
7. Select the desired length.

[NORMAL]: Trails are displayed in a single, continuous line with a single color.

[12H], [24H] or [48H]: Trails appear in segments. The interval for each segment change depends on your selection, as shown below.

- 12H: One hour intervals.
- 24H: Two hour intervals.
- 48H: Four hour intervals.

Note: When a length other than [NORMAL] is selected, set [3 TRAIL GRADATION] to [SINGLE]. If you select [MULTI], the interval between each colored segment may be difficult to see clearly.

8. Close the menu.

1.37.13 How to set the trail color (C-type only)

The setting for trail coloration depends on the setting for [3 TRAIL GRADATION] and [4 TRAIL LENGTH], as shown in the following table.

Length	Gradation	Setting location
NORMAL	SINGLE	[MAIN] → [2 ECHO] → [0 NEXT] → [4 TRAILS] → [4 TRAIL COLOR]
	MULTI	
[12H], [24H], [48H]	MULTI	[MAIN] → [2 ECHO] → [0 NEXT] → [4 TRAILS] → [0 NEXT] → [6 LONG TRAIL COLOR]
	SINGLE	

Where [TRAIL LENGTH] is set to [NORMAL]

You can assign one of six colors when [4 TRAIL LENGTH] is set to [NORMAL].

1. Open the menu.
2. Select [1 ECHO].
3. Select [0 NEXT].
4. Select [4 TRAILS]. The [TRAILS] menu appears.
5. Select [4 TRAIL COLOR].
6. Select the required color. The available colors are: [GRN] (green), [BLU] (blue), [CYA] (cyan), [MAG] (magenta), [WHT] (white) and [YEL] (yellow).
7. Close the menu.

Where [TRAIL LENGTH] is set to other than [NORMAL]

When [4 TRAIL LENGTH] is set to [12H], [24H] or [48H], you can color the trails with one of two methods: one continuous color, or multicolor.

1. Open the menu.
2. Select [1 ECHO].
3. Select [0 NEXT].
4. Select [4 TRAILS]. The [TRAILS] menu appears.
5. Select [0 NEXT] to show the second page of the menu.
6. Select [6 LONG TRAIL COLOR]. The [LONG TRAIL COLOR MENU] appears (see figure to the right).
7. Select [3 LONG TRAIL COLORS].
8. Set the colors as desired.
Left-click to move the cursor through the colors, spin the scrollwheel to change the highlighted color. The menu shows 12 colors, numbered accordingly from [1] to [12]. The first segment of the trails is assigned the color for number [1].
9. Close the menu.

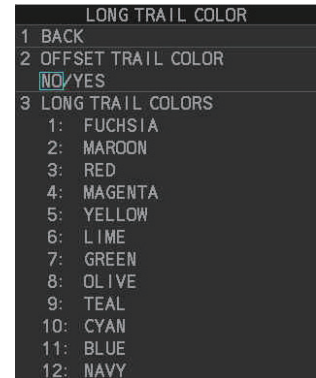

1.37.14 How to remove the colors from a section of a multicolor trail (C-type only)

You can remove the color(s) from a section of a multicolor trail, leaving the selected section as a gray trail. To remove the color(s), follow the procedure below.

Note: This function is only available when [4 TRAIL LENGTH] is set to other than [NORMAL].

1. Open the menu.
2. Select [1 ECHO].
3. Select [0 NEXT].
4. Select [4 TRAILS]. The [TRAIL MENU] appears.
5. Select [0 NEXT] to show the second page of the menu.
6. Select [5 TRAIL GRAY-OUT TIME].
7. Select the start and end times for the period you want to gray-out.
8. Close the menu.

1.37.15 How to offset the colors for multicolored trail (C-type only)

You can “shift” the order of the trail colors. When this function is active, the first color used to paint the trail is changed. For example if you had selected [FUSCHIA] before activating the offset feature, the start color would be [MAROON].

To offset the colors, follow the procedure below.

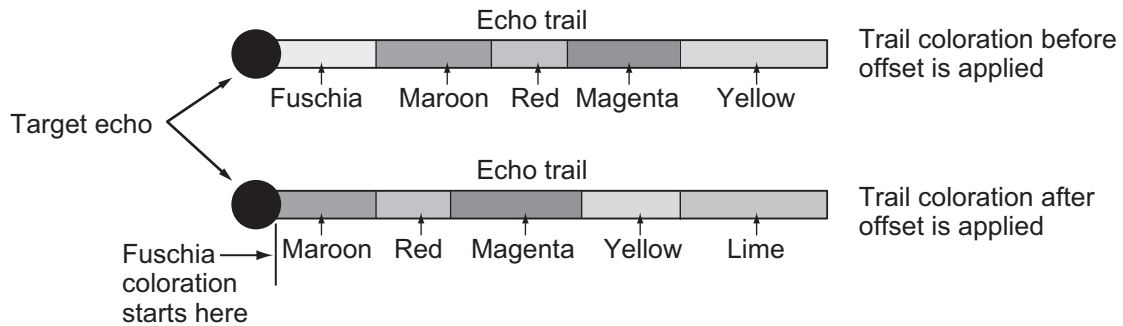

1. Open the menu.
2. Select [1 ECHO].
3. Select [0 NEXT].
4. Select [4 TRAILS]. The [TRAIL MENU] appears.
5. Select [0 NEXT] to show the second page of the menu.
6. Select [6 LONG TRAIL COLOR].
7. Select [2 OFFSET TRAIL COLOR].
8. **To offset the color by one**, select [ON].
To leave the colors in their original order, select [OFF].
9. Close the menu.

1.38 Target Analyzer (C-type only)

The target analyzer function analyzes echoes and assists the operator to determine dangerous targets. This function is particularly useful under heavy rain/snow or where there is surface reflection, which can cause interference and noise.

The target analyzer function can also place hatching over heavy rain areas, reducing the visible interference and allowing a clearer view of potential targets.

Echoes are displayed in five different colors to assist the operator in identifying targets. The colors and their respective echoes change depending on the echo color selected from the [BRILL] menu (see section 1.46) are shown in the table below.

Echo	Selected echo color					
	YEL	GRN	WHT	AMB	M-GRN	M-CYA
Surface reflection	Green	Green	Green	Green	Green	Green
Rain	Gray	Gray	Gray	Gray	Gray	Gray
Moving target	Red	Red	Red	Red	Pink	Pink
Approaching target	Pink	Pink	Pink	Pink	White	White
Other echoes	Yellow	Green	White	Amber	Red to green	Red to blue

The following example figures show the manner in which this function affects displayed echoes.

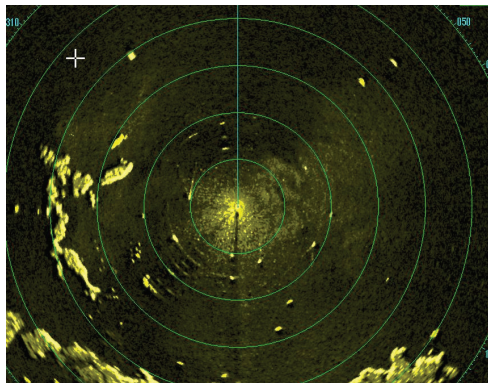

No echo adjustment
(Target analyzer off, EAV off, hatching off)
Rain, moving targets and surface reflections are all displayed with no filtering.

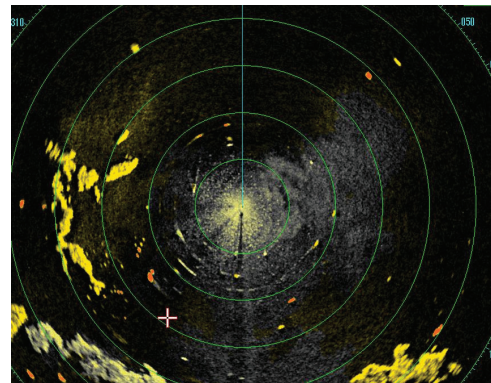

Minimal echo adjustment
(Target analyzer on, EAV off, hatching off)
Echoes are colored, surface reflections are filtered, rain is displayed.

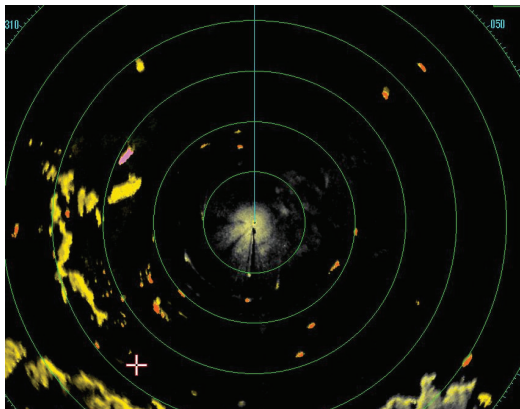

Moderate echo adjustment
(Target analyzer on, EAV on, hatching off)
Echoes are colored, surface reflections and rain are filtered.

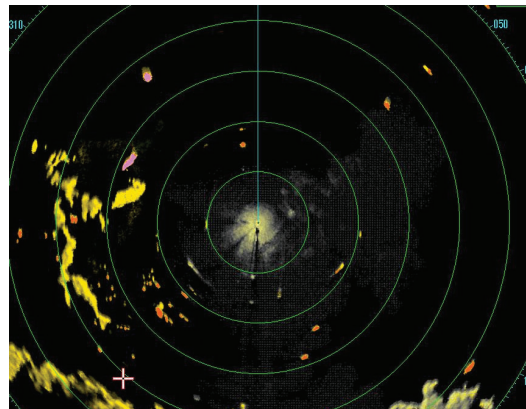

Maximum echo adjustment
(Target analyzer on, EAV on, hatching on)
Echoes are colored, surface reflections are filtered, rain is displayed in gray colored hatching.

1. OPERATIONAL OVERVIEW

Note 1: This function works best when the settings for [GAIN], [STC], [RAIN], [NOISE REJECT] and [VIDEO CONTRAST] are properly adjusted (surface reflections are displayed in green and rain is displayed in gray).

Note 2: This function recognizes moving targets as approaching targets. Buoys and other stationary objects are not recognized as approaching targets by this function.

Note 3: The target analyzer function requires a short period of time to analyze echoes and display them on-screen. If your antenna revolves at more than 40 rpm, moving targets may not be displayed correctly. For this reason, caution is advised when using the target analyzer function.

Note 4: The target analyzer function's performance may be affected by factors such as target size, weather and sea conditions, physical equipment configuration, offset settings and other factors.

What is "hatching"?

Where echo averaging may hide light rain on the display, the hatching feature, when activated, places a gray "veil" over the areas where rain is detected. This allows the operator to see where the rain is without affecting the quality of the displayed echoes.

1.38.1 How to activate/deactivate the target analyzer

1. Open the menu.
2. Select [1 ECHO].
3. Select [2 CUSTOMIZED ECHO].
4. Select [5 TARGET ANALYZER].
5. Select [OFF] to deactivate the function, or [ON] to activate the function.
6. Select [HATCHING].
7. Select [OFF] to deactivate the function, or [ON] to activate the function.
8. Close the menu.

1.39 Target Alarm

The target alarm serves to alert the navigator to targets (ships, landmasses, etc.) entering a specific area, with audiovisual alerts.

The operator can set the alarm zones at any location, with any size, however, the zones must be inside the operational display area.

Note: The target alarm boxes are not displayed when the setting for [AZ/ALR SELECT] in the [TT•AIS] menu is set to the default setting [ACQUISITION ZONE]. To enable this function, set [AZ/ALR SELECT] in the [TT•AIS] menu to [TARGET ALARM ZONE].

 CAUTION
<ul style="list-style-type: none"> ♦ The alarm should not be relied upon as the sole means for detecting possible collision situations. ♦ A/C SEA, A/C RAIN and GAIN controls should be properly adjusted to be sure the alarm system does not overlook target echoes.

1.39.1 How to set a target alarm

The procedure below shows how to set a target alarm using the figure below as an example. The alarm boxes are labeled [1:] and [2:], and are located at the bottom-right of the screen, near the VRM boxes.

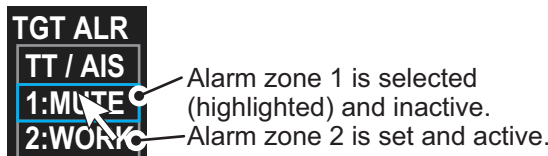

1. Select the appropriate alarm box, then left-click. The cursor jumps into the operational display area and the indication "SET" appears inside the target alarm box selected.
2. Using the trackball, move the cursor to Point A, then left-click.
3. Using the trackball, move the cursor to Point B, then left-click. The indication "SET" is replaced with "WORK" in the box. The target alarm zone's lines are shown as dashed lines.

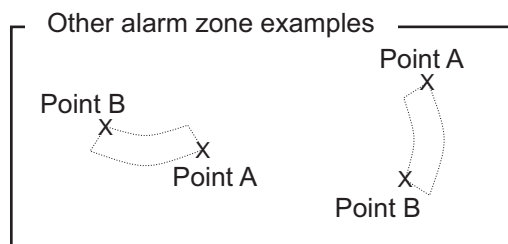
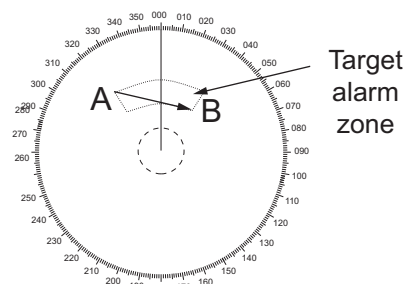

Note 1: To create a 360° alarm zone, set Point B at the same location as Point A.

Note 2: Two alarm zones can be set simultaneously. The second alarm zone is only available when the first alarm zone is active, however.

Note 3: When the target alarm zone is not within the range in use the indication "UP RNG" appears to the right of the target alarm box. In this case select a range that will display the target alarm zone.

1.39.2 How to mute the target alarm

A target in the target alarm zone produces both visual (flashing) and audible (beep) alarms. To silence the audio alarm select the appropriate target alarm box then left-click. The target alarm box indication shows "MUTE". This will deactivate the audio alarm but will not stop the flashing of the offending target. You can also stop the alarm by deactivating the target alarm zone (see section 1.39.3).

To reactivate the audio alarm, select the target alarm box then left-click to show "WORK" in the box.

1.39.3 How to deactivate a target alarm

Select the target box to be deactivated, then press and hold the **left button** on the Control Unit.

Note: When both alarm zones are active, the second ([2:]) alarm zone must be deactivated before the first ([1:]) can be deactivated.

If both zones are active when you try to deactivate zone [1:], the system releases two audible beeps and shows the message "DELETE ALR2 FIRST".

1.39.4 How to change target alarm attributes

You can select the echo strength level that triggers the alarm, the condition that generates the alarm and the volume of the audio alarm as follows:

1. Open the menu.
2. Select [4 ALERTS].
3. Select [6 TARGET ALARM].
4. Select [2 ALR1 MODE] or [3 ALR2 MODE] as appropriate, then press the **ENTER MARK** key.
5. Select [IN] or [OUT] as appropriate, then press the **ENTER MARK** key.
 [IN]: Targets entering the alarm zone trigger the alarm.
 [OUT]: Targets leaving the alarm zone trigger the alarm.
6. Select [4 LEVEL].
7. Select the appropriate level of echo strength to trigger the alarm, then press the **ENTER MARK** key. [1]: weak echoes can trigger the alarm, [4]: only strong echoes trigger the alarm.
8. Select [1 BACK] to return to the [ALERT] menu.
9. Select [3 ALERT VOLUME].
10. Select [OFF], [LOW], [MID] or [HIGH] as appropriate, then press the **ENTER MARK** key.
Note 1: This setting is applied to all alarms output from this radar system.
Note 2: The [OFF] options is not shown for IMO-type radars.
11. Close the menu.



1.40 PI (Parallel Index) Lines

PI lines are useful for keeping a constant distance between own ship and a coastline or a partner ship when navigating.

You can control the presentation and interval of the PI lines from the [PI Line] box, which is at the lower-left corner of the screen (see example figure below).

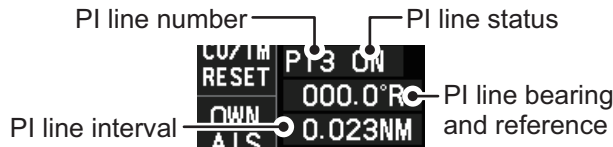
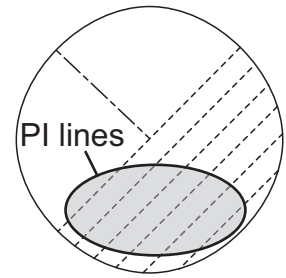

1.40.1 How to show/hide the PI lines

You can show or hide the PI lines as required with one of the following procedures.

Using the on-screen box

1. Place the cursor on the PI line number or PI line status in the PI line box.
2. Spin the scrollwheel to select the PI line (PI1 to PI6) you want to show or hide.
Note: PI5 and PI6 are only available when [SET MAXIMUM PI LINES] is set to [1].
3. Left-click to toggle between [ON] (PI line is shown) or [OFF] (PI line is hidden).

Using the control unit (RCU-031 only)

1. Press **6 INDEX LINE** to select the PI line you want to use (PI1 to PI6).
Note: PI5 and PI6 are only available when [SET MAXIMUM PI LINES] is set to [1].
2. Press and hold **6 INDEX LINE** to toggle the selected PI line on or off.

1.40.2 How to set the maximum number of lines to display

You can select the maximum number of PI lines to display. The actual number of lines visible depends on the line interval (see section 1.40.3).

1. Open the menu.
2. **For IMO-types**, select [3 NAV TOOLS].
For C-types, select [3 CURSOR•EBL•VRM].
3. Select [2 PI LINES]. The [PI LINES] menu appears.
4. Select [3 SET MAXIMUM PI LINES].
5. Select the appropriate option.
For IMO-types, the maximum number of PI lines available is 6.
For C-types, the maximum number of PI lines available is 11.
If you set [1] as the maximum, PI1 through PI6 are available for use. For all other options, only PI1 through PI4 are available for use. This setting is applied to all PI lines.
6. Close the menu.

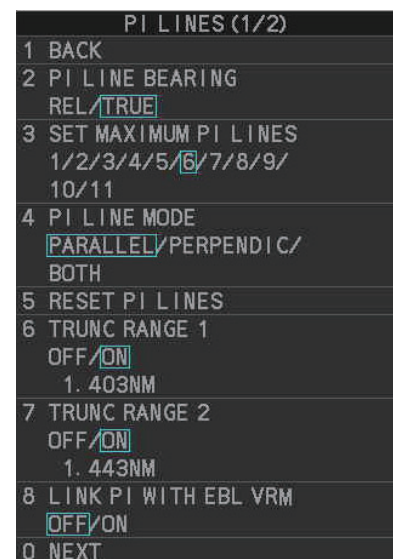

1.40.3 How to change PI line bearing and interval

1. If not already displayed, show a PI line, referring to section 1.40.2.
2. Place the arrow on the PI line bearing and reference indication in the [PI Line] box.
3. Spin the scrollwheel to adjust the PI line bearing, between 000.0° to 359.9°.
4. Place the cursor on the PI line interval.
5. Spin the scrollwheel to adjust the PI line interval.
A negative interval value moves to the PI line to one side of the line which intersects the own ship position. A positive interval value moves the line to the other side of the own ship position.

How to link PI lines with the EBL and VRM (C-types only)

You can link the PI line bearing with the EBL's bearing and the PI line interval with the VRM distance; this allows you to adjust the PI lines with the EBL and VRM controls. To link the PI lines with the EBL/VRMs, do the following:

1. Open the menu.
2. Select [3 CURSOR•EBL•VRM].
3. Select [2 PI LINES]. The [PI LINES] menu appears.
4. Select [8 LINK PI WITH EBL VRM].
5. Select [ON] to link the PI lines with the EBL/VRMs, select [OFF] to disable the feature.
If you selected [ON], the PI line bearing and interval indications, in the PI line box, are hidden. To adjust the PI line bearing or interval, adjust the EBL or VRM accordingly.
6. Close the menu.

1.40.4 How to change the PI line bearing reference (C-type only)

PI line bearing reference can be relative to own ship's heading (Relative) or referenced to North (True) as below.

Note: For IMO-types, PI line bearing reference is fixed to North (True).

1. Open the menu.
2. Select [3 CURSOR•EBL•VRM].
3. Select [2 PI LINES]. The [PI LINES] menu appears.
4. Select [2 PI LINE BEARING].
5. Select [REL] or [TRUE] as appropriate, then press the **ENTER MARK** key.
6. Close the menu.

1.40.5 How to change the PI line orientation

PI lines orientation can be selected from parallel or perpendicular. This function is available when [SET MAXIMUM PI LINES] is set for other than [1].

1. Open the menu.
2. **For IMO-types**, select [3 NAV TOOLS].
For C-types, select [3 CURSOR•EBL•VRM].
3. Select [2 PI LINES]. The [PI LINES] menu appears.
4. Select [4 PI LINE MODE].
5. Select [PARALLEL], [PERPENDIC], or [BOTH]* as appropriate, then press the **ENTER MARK** key.
 - [PARALLEL]: when the PI line bearing is set to 0°, the lines are parallel with the heading line.
 - [PERPENDIC]: when the PI line bearing is set to 0°, the lines are perpendicular with the heading line.
 - [BOTH]: shows PI lines on both sides of the heading line. When the PI line bearing is set to 0°, the lines are perpendicular with the heading line.
- *: Not available for IMO-types.
6. Close the menu.

1.40.6 How to reset the PI lines to default (ship's heading)

You can automatically return PI lines to default orientation. The PI lines are reset in the following manner:

- [PARALLEL] or [BOTH] set as PI line orientation: parallel with the heading line.
- [PERPENDIC] set as PI line orientation: perpendicular with the heading line.

From the PI line box

1. Place the cursor on the PI line number or PI line status in the PI line box.
2. Spin the scrollwheel to select the PI line (PI1 to PI6) whose default orientation you want to reset.
3. Press and hold the **left button**. PI lines which are displayed on-screen are restored to their default orientation.

From the menu

1. Open the menu.
2. **For IMO-types**, select [3 NAV TOOLS].
For C-types, select [3 CURSOR•EBL•VRM].
3. Select [2 PI LINES]. The [PI LINES] menu appears.
4. Select [5 RESET PI LINES]. All PI lines are reset.
5. Close the menu.

1.40.7 How to change PI line length

You can change the length of the PI lines. This function is only available when [SET MAXIMUM PI LINES] is set to [1]. If not already displayed, you can show PI lines for which you wish to change the length by referring to section 1.40.2.

1. Open the menu.
2. **For IMO-types**, select [3 NAV TOOLS].
For C-types, select [3 CURSOR•EBL•VRM].
3. Select [2 PI LINES]. The [PI LINES] menu appears.
4. Select [6 TRUNC RANGE 1].
5. Select [ON].
6. Spin the scrollwheel to adjust the front PI line length. The available range is 0.000 NM to 24.000 NM. All PI lines beyond this mark will be hidden.
7. Left-click to confirm the setting.
8. Select [7 TRUNC RANGE 2].
9. Select [ON].
10. Spin the scrollwheel to adjust the front PI line length. The available range is 0.000 NM to 24.000 NM. All PI lines beyond this mark will be hidden.
11. To change the length of other PI lines, activate the line you wish to adjust, then repeat steps 1 through 10.
12. Close the menu.

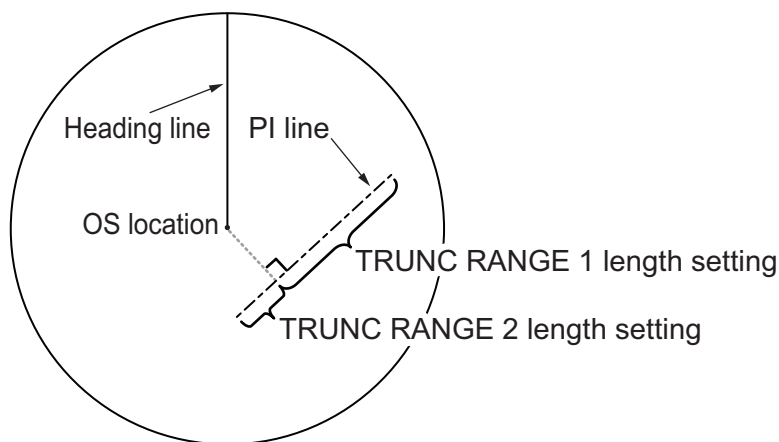

1.40.8 How to change the PI line color (C-types only)

You can change the PI line color with the following procedure.

1. Open the menu.
2. Select [3 CURSOR•EBL•VRM].
3. Select [2 PI LINES].
4. Select [0 NEXT] to show the second page of the menu.
5. Select [2 PI LINE COLOR].
6. Select the desired color from the menu. The options are: [RED] (red), [GRN] (green), [BLU] (blue), [YEL] (yellow), [CYA] (cyan), [MAG] (magenta), [WHT] (white), [ORG] (orange, default).
7. Close the menu.

1.41 How to Use the Net (Diamond) Cursor (C-type only)

The net cursor is used to depict your fishing net on the radar display. It is especially useful for bottom trawlers for knowing where the net is located. Enter the dimensions of your net in the menu to show the net in scale on the display.

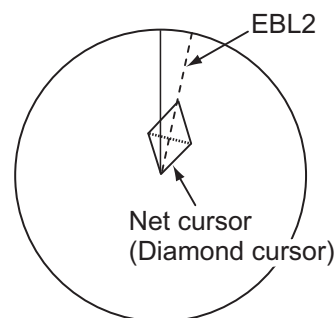

1.41.1 How to activate the net cursor

To activate the net cursor, do the following procedure.

1. Open the menu.
2. **For IMO-types**, select [3 NAV TOOLS].
For C-types, select [3 CURSOR•EBL•VRM].
3. Select [5 NET CURSOR]. The [NET CURSOR] menu appears.

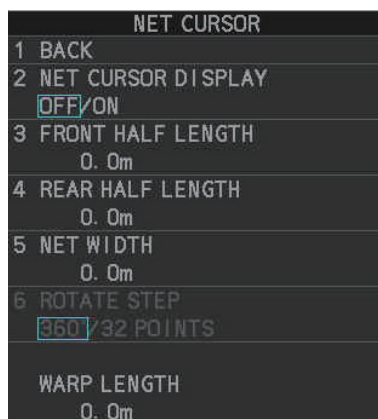

4. Select [2 NET CURSOR DISPLAY].
5. Select [ON] to activate, or [OFF] to deactivate the net cursor.
6. Close the menu.

1.41.2 How to set the net cursor dimensions and orientation

1. Open the menu.
2. **For IMO-types**, select [3 NAV TOOLS].
For C-types, select [3 CURSOR•EBL•VRM].
3. Select [5 NET CURSOR].
4. [3 FRONT HALF LENGTH].
5. Rotate the **scrollwheel**, then left-click to set the length of selected net section.

Note: The length appears in the [WARP LENGTH] indication. Adjust the values so that the total length for front and rear is equal to, or less than 3000m.

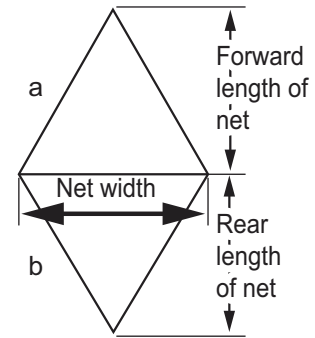

6. Select [4 REAR HALF LENGTH].
 7. Rotate the **scrollwheel**, then left-click to set the length of selected net section.
- Note:** The length appears in the [WARP LENGTH] indication. Adjust the values so that the total length for front and rear is equal to, or less than 3000m.
8. Select [5 NET WIDTH].
Select [360°] or [32 POINTS], then left-click.
The net cursor moves in the same manner as EBL2 moves. Select [360°] to move with 0.1° steps, or select [32 POINTS] to move with 11.25° steps.
 9. Rotate the **scrollwheel**, then left-click to set the net width.
 10. Select [6 ROTATE STEP].
Select [360°] or [32 POINTS], then left-click.
The net cursor moves in the same manner as EBL2 moves. Select [360°] to move with 0.1° steps, or select [32 POINTS] to move with 11.25° steps.
 11. Close the menu.
 12. Insert the net cursor at the location of the net with the EBL offset function.
 - 1) Press the **EBL OFFSET** key.
 - 2) Move the cursor onto the net location, then left-click.
 13. Rotate the **EBL** knob to adjust the orientation the net cursor until the cursor is in line with, or against, the tide direction.

1.42 Circle Cursor (C-types only)

The CIRCLE cursor is a handy measuring tool which works similar to a VRM, in that the circle itself can be used to measure distance. However, where the VRM is fixed to a location on the screen, the circle cursor can be fixed to a geographical location or even another vessel's echo.

Note: Before using this feature, make sure the [MAP ON/OFF] button on the Instant-Access bar™ is set to [ON]. This feature is not available when the map is turned off.

1. If the cursor is hidden, show the cursor. For how to show the cursor, see section 1.7.1.
2. Place the cursor inside the operational display area, then right-click to show the [CURSOR] menu.
3. Select [0 NEXT], then select [4 CIRCLE CURSOR].
The cursor now appears with a large white circle, as shown in the following example.

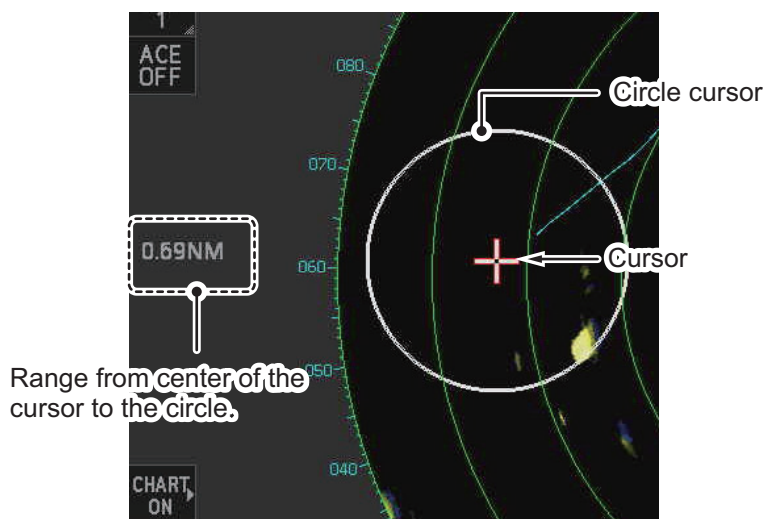

4. Move the cursor to the location where you want to start measuring from.
5. Spin the scrollwheel to adjust the size (distance) of the circle cursor. The radius (distance from the cursor to the circle cursor) appears at the left-center of the screen.
Note: The size of the circle cursor is directly related to the range at the time it was inserted. If you increase/decrease the range after inserting the circle cursor, the on-screen size of the cursor also changes accordingly.
6. Left-click to fix the circle cursor to that location/echo.
To remove the circle cursor, repeat steps 2 and 3, then right-click.

1.43 Zoom

The zoom function enlarges an area of interest as large as twice the normal viewing size, in the [INFORMATION BOX]. Zoom can be selected using the control unit or from a preset function key (see section 1.8 for how to assign functions to the function keys).

Zoom is not available when the [INFORMATION BOX] setting for [TARGET DATA] is [LARGE].

To enable/disable the zoom magnification, select the appropriate zoom setting ([2TIMES]: Enables magnification at 2×, or [3TIMES]: Enables magnification at 3×) from the [ZOOM] option in the [INFORMATION BOX] menu. (See section 1.48.)

Note: The zoom function is not available when the [TRUE VIEW] located on the second page of the [ECHO] menu) is set to [ON].

1. Select the operational display area, then right-click to show the [CURSOR] context menu.
2. Select [ZOOM].
3. Place the cursor inside the operational display area, then left-click. The cursor is now displayed with a zoom box.
4. Place the cursor and zoom box at the location you wish to zoom, then left-click to anchor the box.
If the zoom box is not placed where you intended to place it, left-click twice, then move the box to the correct place. Left-click to anchor the box.
5. Right-click to complete the procedure. The selected area is displayed on the right-side of the screen and the cursor returns to normal shape.

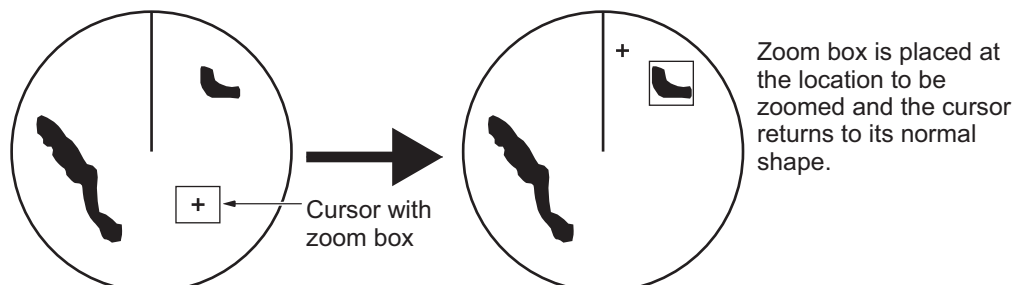

To disable the zoom function, repeat steps 1 to 3. At step 3, the zoom box is removed from the display.

Note 1: Where the zoom function is assigned to a function key, press the function key to cycle through the zoom settings in the following order: [OFF] → [2TIMES] (2× magnification) → [3TIMES] (3× magnification) → [OFF]...

This operation works in direct relation with the settings selected from the [ZOOM] option in the [INFORMATION BOX] menu. To use the zoom function on a different area, do the procedure (step 1 to step 5) listed above.

Note 2: For C-types only, some marks can be inserted from the zoom window. Marks inserted in this manner appear on the main screen and are not shown in the zoom window. See the list below for mark availability with this feature.

- **Available:** TT, map mark, waypoints, GOTO point (requires [SET GOTO METHOD] to be set as [1POINT])
- **Not available:** Nav line, drop mark, origin mark, area mark, MOB, GOTO point (when [SET GOTO METHOD] is set as [100POINTS]), mark received from an external source.

1.44 How to Use Marks

1.44.1 Heading line mark

The heading line is a line from the own ship position to the outer edge of the radar display area and appears at zero degrees on the bearing scale in HEAD UP mode. The orientation of the line changes depending on the ship orientation in NORTH UP and True Motion modes.

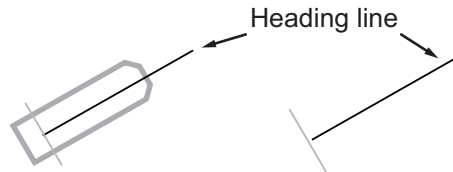

How to hide the heading line temporarily

To temporarily extinguish the heading line to look at targets existing dead ahead of own ship, press and hold the **HL OFF** key, or place the cursor on the [HL OFF] box in the InstantAccess bar™ then left-click and hold.

In addition to the heading line, the stern marker and all graphics within the operational display area are also erased. To redisplay the heading line, etc., release the key or the **left button**.

How to change the heading line thickness (C-types only)

You can change the thickness of the heading with the following procedure.

1. Open the menu.
2. Select [2 MARKS•PLOTTER], then select [0 NEXT].
3. Select [2 HEADING LINE WIDTH].
4. Select the desired thickness.
 - [NORMAL]: the heading line appears at standard width.
 - [X3]: the heading appears three times thicker than at [NORMAL].
 - [X5]: the heading appears five times thicker than at [NORMAL].
 - [X7]: the heading appears seven times thicker than at [NORMAL].
5. Close the menu.

MARKS•PLOTTER (2/2)	
1	BACK
2	HEADING LINE WIDTH [NORMAL]/X3/X5/X7
3	HEADING LINE COLOR RED/GRN/BLU/YEL/ [CYA]/MAG/WHT
4	GRID COLOR RED/[GRN]/BLU/YEL/ CYA/MAG/WHT
5	NORTH MARK WIDTH [NORMAL]/X3/X5/X7

How to change the color of the heading line (C-types only)

1. Open the menu.
2. Select [2 MARKS•PLOTTER], then select [0 NEXT].
3. Select [3 HEADING LINE COLOR].
4. Select the desired color.
5. Close the menu.

1.44.2 How to hide/show the stern mark

The stern marker, which is a dotted line, appears opposite to the heading line.

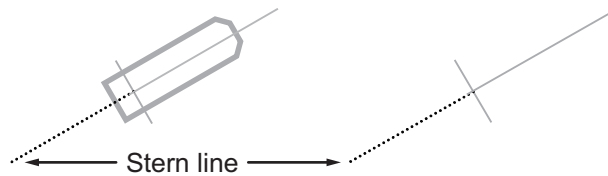

To display or erase this marker do the following:

1. Open the menu.
2. **For IMO-types**, select [2 MARKS]
For C-types, select [2 MARKS•PLOTTER].
3. **For IMO-types**, select [3 STERN MARK].
For C-types, select [7 STERN MARK].
4. Select [ON] or [OFF] as appropriate.
5. Close the menu.

1.44.3 North mark

The north mark is displayed as a short dotted line on the inside edge of the operational display area. In HEAD UP mode, the north mark moves according to the own ship bearing.

The north mark is hidden when the radar is in standby mode.

How to change the mark thickness (C-types only)

If your radar is a C-type, you can change the thickness of the north mark with the following procedure.

1. Open the menu.
2. Select [2 MARKS•PLOTTER], then select [0 NEXT].
3. Select [5 NORTH MARK WIDTH].
4. Select the desired width.
 - NORMAL: North mark is display with the normal width.
 - X3: Increase width to three times the size of normal.
 - X5: Increase width to five times the size of normal.
 - X7: Increase width to seven times the size of normal.
5. Close the menu.

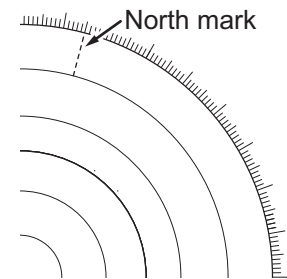

1.44.4 Bearing ring

The bearing ring appears on the outer edge of the operational display area and is used to estimate the bearing of echoes on the screen.

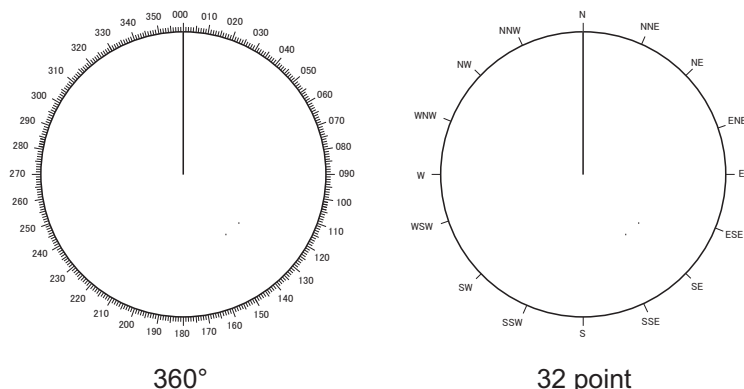

For IMO-types, the display format for the bearing ring is fixed at [360°] and cannot be changed. **For C-types**, you can select either [360°] or [32 POINTS], however, when using HEAD UP or STERN UP orientation mode, this setting is fixed at [360°].

Changing the display format of the bearing ring (C-types only)

1. Open the menu.
2. Select [3 CURSOR•EBL•VRM].
3. Select [7 BEARING CURSOR].
4. Select [360°] or [32 POINTS] as desired.
5. Close the menu.

Changing the color of the bearing ring (C-types only)

1. Open the menu.
2. Select [3 CURSOR•EBL•VRM], then select [0 NEXT].
3. Select [2 BEARING CURSOR COLOR].
4. Select the desired color.
If you select [OFF], the cursor color is determined by the selected color scheme in use (see section 1.46).
5. Close the menu.

1.44.5 How to set up the own ship mark

The own ship mark indicates own position on the display. It can be turned on or off and its configuration selected from the [MARK] menu. Two configurations are available: minimized symbol and scaled symbol. If the largest dimension of the symbol gets smaller than 6 mm, the scaled symbol will disappear and the own ship mark will be shown as a minimized symbol. The scaled symbol is scaled to indicate the length and beam of the vessel. Ship's dimensions should be entered at installation to use the scaled ship symbol.

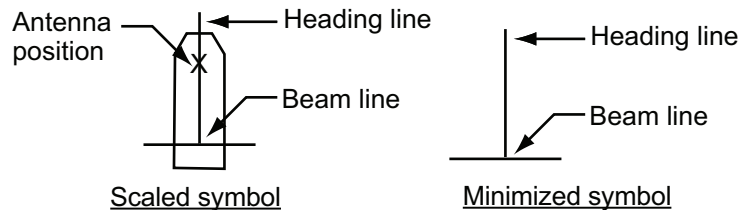

1. Open the menu.
2. **For IMO-types**, select [2 MARKS]
For C-types, select [2 MARKS•PLOTTER].
3. **For IMO-types**, select [2 OWN SHIP MARK].
For C-types, select [6 OWN SHIP MARK].
4. Select [MINIMIZED] or [SCALED] as appropriate.
5. Close the menu.

1.44.6 How to set the barge marker

You can mark the locations of barges on the display with icons.

Note: For IMO-types, this function is not available if [ECDIS] is set to [SERIAL] or [LAN] at installation. Consult your dealer for details.

Set up barge information as follows:

1. Open the menu.
2. **For IMO-types**, select [2 MARKS].
For C-types, select [2 MARKS•PLOTTER].
3. **For IMO-types**, select [6 BARGE MARK].
For C-types, select [9 BARGE MARK].
4. Select [2 BARGE MARK DISPLAY].

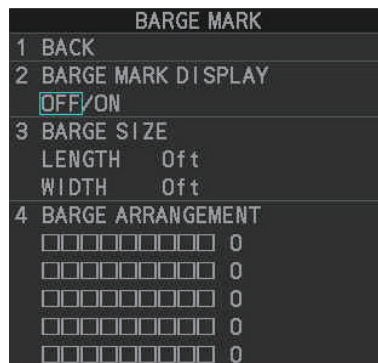

5. Select [ON] to display barge marks, [OFF] to hide barge marks, as appropriate, then press the **ENTER MARK** key.

6. Select [3 BARGE SIZE]. Spin the scrollwheel, then left-click to enter the [LENGTH] and [WIDTH] of the barge.
7. Select [4 BARGE ARRANGEMENT]. This item lets you set a single barge or a barge chain. Spin the scrollwheel to select a value, then left click to move the cursor to the next line. Select number of barges (max. 9) to display. As you spin the scrollwheel the squares light or extinguish and the number of barges selected appears at the right side.

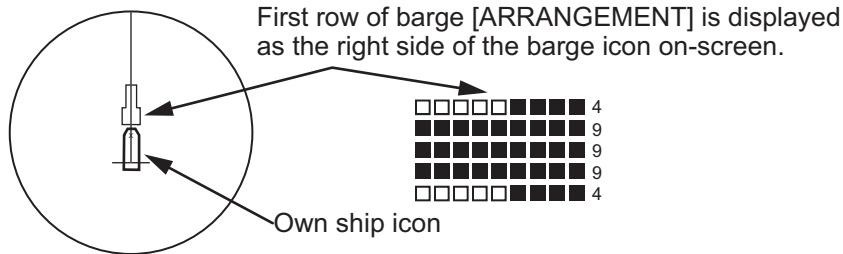

You can also use the number keys on the Control Unit to select the number of barges.

8. Close the menu. The barge mark is now displayed as shown in the example figure on the previous page.

1.44.7 Antenna mark

When the own ship mark menu is set to [SCALED], the antenna location is shown as a blue cross. The location of the antenna, and therefore the antenna mark, is set at installation.

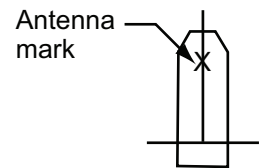

1.45 Drop Mark

The operator can inscribe a drop mark at a selected location to find the range and bearing from own ship to the mark. This can be useful for marking a point to avoid while navigating to a destination.

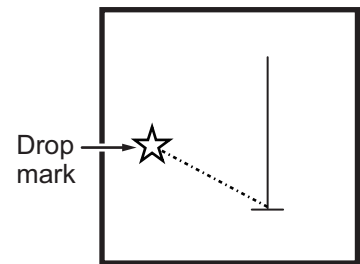

To active the drop mark feature, do the following:

1. Open the menu.
2. **For IMO-types**, select [2 MARKS].
For C-types, select [2 MARKS•PLOTTER].
3. **For IMO-types**, select [4 DROP MARK].
For C-types, select [8 DROP MARK].
4. Select [ON] to enable [DROP MARK]. Two indications appear at the bottom of the screen.



Drop mark boxes show the mark number, bearing and range to the mark.

5. Close the menu.

1.45.1 How to inscribe a drop mark

1. Select a drop mark box, then left-click.
2. Place the cursor at the location to inscribe the drop mark, then left-click.
The drop mark box shows the range and bearing to the marked location.

1.45.2 How to erase drop marks

Select the drop mark to be erased, then press and hold the **left button**. The mark is erased and the range/bearing indications are no longer shown.

1.46 Brilliance and Color Schemes

Brilliance and color schemes are preset “palettes” that let you change the brilliance and color of on-screen data together.

1.46.1 How to select a brilliance and color scheme

The system has four presets of brilliance and color settings to choose from. Each preset is customizable (see section 1.46.3).

The following list shows each preset along with their default settings.

- [PLT1] (default [DAY-GRY]): preset for use in daylight with a gray background.
- [PLT2] (default [DAY-BLU]): preset for use in daylight with a blue background.
- [PLT3] (default [DUSK-BLU]): preset for use at dusk with a blue background.
- [PLT4] (default [NIGHT-GRY]): preset for use at night with a gray background.

To change the current scheme, do the following:

1. Place the cursor on the [PLT] indication, inside the brilliance settings box at the bottom-left of the screen.

Place cursor here, then left-click to change brilliance preset, right-click to open the [BRILL] menu.



2. Spin the scrollwheel to show the scheme you want to use, then left-click.
You can also left-click the indication to cycle through the schemes.

1.46.2 How to change the color schemes settings

1. Referring to section 1.46.1, select the scheme whose settings you want to change.
2. Open the menu.
3. Select [9 INITIAL SETTINGS].
4. Select [2 BRILL]. The [BRILL] menu appears.



5. Select the appropriate item to adjust.

Menu item	Description
Page 1	
[2 ECHO COLOR]	Changes the color used to display echoes. The available colors are: [YEL] (yellow), [GRN] (green), [WHT] (white), [AMB] (amber), [M-GRN]* (mutli-green), [M-CYA]* (multi-cyan). *: [M-GRN] and [M-CYA] are not shown on IMO-types. If you select [M-GRN] or [M-CYA], the echo color changes depending on the echo strength. <ul style="list-style-type: none"> • [M-GRN]: red for strong echoes, ranging through to green for weak echoes. • [M-CYA]: red for strong echoes, ranging through to green for weak echoes.
[3 PALETTE]	Changes the color scheme (see subsection 1.46.3).
[4 CONTROL PANEL]	Adjusts control panel back-light brilliance.
[5 CHARACTERS]	Adjusts on-screen text brilliance.
[6 CURSOR]	Adjusts cursor brilliance.
[7 ECHOES]	Adjusts the echo brilliance.
[8 TRAILS]	Adjusts echo trail brilliance.
[9 HL]	Adjusts heading line brilliance.
Page 2	
[2 RANGE RINGS]	Adjusts range ring brilliance.
[3 BEARING CURSOR]	Adjusts bearing cursor brilliance.
[4 EBL]	Adjusts EBL line brilliance.
[5 VRM]	Adjusts VRM line brilliance.
[6 PI LINES]	Adjusts PI line brilliance.
[7 TT SYMBOLS]	Adjusts target trail symbol brilliance.
[8 AIS SYMBOLS]	Adjusts AIS symbol brilliance.
[9 L/L GRID]	Adjusts latitude/longitude grid brilliance.
Table continued on the following page.	

1. OPERATIONAL OVERVIEW

Menu item	Description
<i>Table continued from the previous page.</i>	
Page 3	
[2 PLOTTER]	Adjusts latitude/longitude grid brilliance.
[3 CHART]	Adjusts chart brilliance. (C-types only.)
[4 DEPTHLINE]	Adjusts depth line (bathymetry) brilliance. (C-types only.)

6. Spin the scrollwheel, or press the appropriate menu number to change or adjust the settings, then left-click, or press the **ENTER MARK** key to confirm the setting.
7. Close the menu.

1.46.3 How to change the color schemes settings

This radar provides eight sets of color and brilliance schemes to match any ambient lighting condition and can be assigned to a [BRILL] box preset.

1. Place the cursor on the [PLT] indication, inside the brilliance settings box at the bottom-left of the screen.
The indication appears highlighted with a light-blue colored box.
Right-click to show the [BRILL1] box menu.
2. Select [3 PALETTE].
3. Select the appropriate palette, then press the **ENTER MARK** key. The default settings for each palette are shown in the following table.

Display item	Palette							
	DAY-GRY	DAY-BLU	DAY-GRN	DUSK-GRY	DUSK-BLU	DUSK-GRN	NIGHT-GRY	NIGHT-BLU
Screen brilliance	100	100	100	40	40	40	4	4
Panel brilliance	15	15	15	7	7	7	3	3
Character brilliance	8	8	8	8	8	8	8	8
Cursor brilliance	15	15	15	12	12	12	12	12
Echo brilliance	15	15	15	12	12	12	12	12
Trail brilliance	9	9	9	9	9	9	9	9
Heading Line brilliance	15	15	15	15	15	15	15	15
Stern Line brilliance	15	15	15	7	7	7	15	15
Bearing ring brilliance	15	15	15	6	6	6	15	15
EBL brilliance	15	15	15	12	12	12	12	12
VRM brilliance	15	15	15	12	12	12	12	12
PI Line brilliance	15	15	15	12	12	12	12	12
TT symbol brilliance	15	15	15	12	12	12	12	12
AIS symbol brilliance	15	15	15	12	12	12	12	12
LL Grid brilliance	15	15	15	12	12	12	12	12
Mark brilliance	15	15	15	12	12	12	12	12
Chart brilliance ^{*1}	7	7	7	6	6	6	6	6
Depth line brilliance ^{*1}	7	7	7	6	6	6	6	6
Character color ^{*2}	White	White	Green	White	White	Green	Orange	White

Table continued on the following page.

Display item	Palette							
	DAY-GRY	DAY-BLU	DAY-GRN	DUSK-GRY	DUSK-BLU	DUSK-GRN	NIGHT-GRY	NIGHT-BLU
<i>Table continued from the previous page.</i>								
Background color* ²	Gray/black	Blue/dark blue	Gray/black	Dark gray/dark blue	Dark blue/blue	Dark gray/black	Dark gray/black	Dark blue/blue
ODA color* ²	Black	Dark blue	Black	Dark blue	Blue	Black	Black	Blue
* ¹ : Available for C-types only								
* ² : This setting is fixed and cannot be changed.								

4. Close the menu.

1.47 How to Display and Set Up Navigational Data

Wind, depth, ocean current, water temperature, date and time and waypoint data can be displayed on this radar, however appropriate sensors are required.

1.47.1 How to set up the navigational data

1. Open the menu.
2. Select [7 INFORMATION BOX].



3. Select [4 NAV DATA SETTINGS].

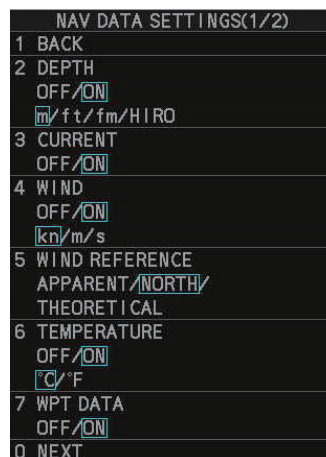

1. OPERATIONAL OVERVIEW

- Referring to the table below, set the appropriate menu item(s).

Menu item	Available settings
[DEPTH]	[OFF], [ON]; [m], [ft]
[DEPTH GRAPH SCALE]* ¹	[10], [20], [50], [100], [200], [500] (m)
[DEPTH MARK]* ¹	[000] to [500] (m)
[CURRENT]	[OFF], [ON]
[WIND]	[OFF], [ON]; [kn], [m/s]
[WIND REFERENCE]	[APPARENT], [NORTH], [THEORETICAL]
[TEMPERATURE]	[OFF], [ON]; [°C], [°F]
[WPT DATA]* ¹	[OFF], [REL], [TRUE]
[MOB DATA]* ²	[OFF], [ON]
[HIRO SETTING]* ²	[1.0000] to [1.9999]
* ¹ : IMO-types only; * ² : C-types only.	

- Close the menu.

1.47.2 How to display navigational data

- Open the menu.
- Select [7 INFORMATION BOX].
- Select [3 DISPLAY NAV DATA].
- Select [ON] to display navigational data, [OFF] to hide navigational data, then press the **ENTER MARK** key.
- Close the menu.

1.48 How to Use the Information Box

The information box shows target data, navigational data and zoomed areas of the radar display. To set up the information box, do the following:

- Open the menu.
- Select [7 INFORMATION BOX].
- Select and set the appropriate menu item, referring to the table below.
- Close the menu.

Menu item	Settings	Description
[2 OWN SHIP INFO]	See section 1.10, section 1.11 and section 1.12 for details.	Set up various own ship information, such as sensors used for position fix, date and time format/offsets, heading and speed sensors used.
[3 DISPLAY NAV DATA]	<ul style="list-style-type: none"> OFF ON 	<ul style="list-style-type: none"> Disable navigational data display. Enable navigational data display.
[4 NAV DATA SETTINGS]	See section 1.47 for details.	Set up the format in which various navigational data is displayed in the [INFORMATION BOX].
[5 ZOOM]	<ul style="list-style-type: none"> OFF 2TIMES 3TIMES 	<ul style="list-style-type: none"> Disable zoom magnification. Set zoom magnification at 2×. Set zoom magnification at 3×.
<i>Table continued on the following page.</i>		

Menu item	Settings	Description
<i>Table continued from the previous page.</i>		
[6 Z O O M D I S P L A Y]	<ul style="list-style-type: none"> • STAB GND • STAB HDG • STAB NORTH • TT TRACK 	<ul style="list-style-type: none"> • Ground stabilized zoom (Geographically fixed). • Heading stabilized zoom (Relative). • North stabilized zoom (True). • Tracked targets are zoomed.
[7 TARGET DATA]	<ul style="list-style-type: none"> • 1BOX • 2BOX • 3BOX • LARGE • TT 5BOX 	See the figure on the following page.
[8 DISPLAY TT COORDS]	<ul style="list-style-type: none"> • OFF • ON 	<ul style="list-style-type: none"> • Disable coordinates display for TT targets. • Enable coordinates display for TT targets. When enabled, the data fields for CPA, TCPA, BCR and BCT are replaced with the coordinates for the TT target:
[9 NAV DATA COLOR]	<ul style="list-style-type: none"> • STD • CHART COLOR 	<ul style="list-style-type: none"> • Data appears in green color. • Data color is based on chart. <p>Note: When CHART COLOR is selected, invalid data and low-integrity data appear in orange or yellow color respectively, regardless of the chart color.</p>

1. OPERATIONAL OVERVIEW

Zoom and navigational data are displayed here.	Zoom and navigational data are displayed here.	Zoom and navigational data are displayed here, but can be hidden by TT/AIS data.	Zoom and navigational data are displayed here.	Only TT Data is displayed
Zoom and navigational data are displayed here.	Zoom and navigational data are displayed here, but can be hidden by TT/AIS data.	Zoom and navigational data are displayed here, but can be hidden by TT/AIS data.		Only TT Data is displayed
Zoom can be displayed here, but can be hidden by TT/AIS data.	Zoom can be displayed here, but can be hidden by TT/AIS data.	Zoom can be displayed here, but can be hidden by TT/AIS data.	Only TT/AIS Data is displayed in the large box. Up to three AIS targets or up six TT targets. For MU-270W configurations, up to two TT targets can be shown.	Only TT Data is displayed
1BOX	2BOX	3BOX	LARGE	TT 5BOX (C-types only)

- TT/AIS data displayed in the information box is shown in order of acquisition in the bottom half of the box.
- When the target data is no longer displayed (TT is cancelled, etc.) in the upper box, the previous display is restored.
- When using the 2BOX or 3BOX setting and the bottom half of the information box is full, the upper half is overlaid with the newly acquired TT/AIS target data.
- Each box may display up to two TT targets or one AIS target. (For MU-270W configurations, up to 3three TT targets can be shown)
- When TT 5 BOX is selected, only TT data is displayed. AIS data, ZOOM and other data are not displayed.

1.49 Interswitch

The interswitch of this radar uses an Ethernet to transfer video and control signals. A digital signal transfers the video and control signals. You can connect up to four antennas and four display units. Set radar display and antenna groups from the [ANTENNA SELECT] display.

When you switch to a different antenna, the heading skew and timing adjustment (set at installation) for that antenna are automatically applied.

The [ANTENNA] box at the upper left position shows current antenna selection.

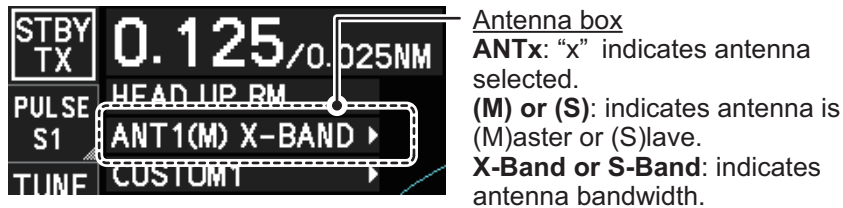

1.49.1 How to display antenna information

1. Open the menu.
2. Select [9 INITIAL SETTINGS].
3. Select [3 SELECT ANTENNA]. The [SELECT ANTENNA] menu appears.

Note: You can also access the [SELECT ANTENNA] menu by right-clicking the [ANTENNA] box at the top-left of the screen.

SELECT ANTENNA	
1	BACK
ANT 1 :	X-BAND
25UP	Main Top
ANT 2 :	S-BAND
30UP	Main 2nd
ANT 3 :	X-BAND
12	Fore
ANT 4 :	X-BAND
12	Aft
OWN RADAR NO.1	
2	DISP1 ANT1
	MASTER
	DISP2 ANT2
	MASTER
	DISP3 ANT3
	MASTER
	DISP4 ANT4
	MASTER
9	SAVE INTER-SWITCH
	NO / YES
0	CLEAR INTER-SWITCH
	NO / YES

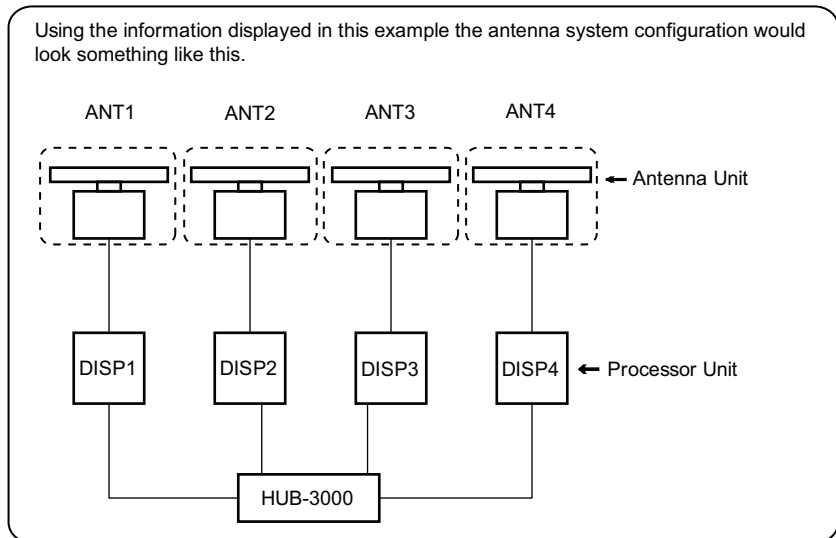

The following information is displayed in the [SELECT ANTENNA] menu:

- Radar band, output power and antenna position of each antenna currently powered. (If an antenna is not powered, its data area is blank.)
- Own ship radar number (radar in use).
- Current antenna and display combinations.

Note: For configurations with processors assigned as DISP5/DISP6/DISP7/DISP8 at installation, the processor unit automatically connects to the system as [SLAVE] when first turned on. You can change this setting after the first connection. See section 1.49.2.

1.49.2 How to preset antenna and display combinations

You can preset the antenna and display combinations for each antenna and display in the radar system. As an example, the procedure below shows how to select the no. 1 antenna unit for the no. 2 display unit.

1. Open the menu.
2. Select [9 INITIAL SETTINGS].
3. Select [3 SELECT ANTENNA]. The [SELECT ANTENNA] menu appears.
4. Select the display unit for which to select an antenna (at the next step). For the purpose of this example, select [DISP2] to select the no. 2 display unit. The indication for the antenna is highlighted.
5. Spin the scrollwheel to toggle between [MASTER] and [SLAVE]. The MASTER system passes on settings such as [CPA], [TCPA] and alarm settings to SLAVE radars connected to the same network.
6. Repeat steps 2 and 3 to set other display and antenna combinations.
7. Select [SAVE INTER-SWITCH], then select [YES] to save your selections.
8. Close the menu.

Antenna selection considerations

- The Inter-switch feature for this radar is available only with other radars of the same series. Do not connect radars from other series (EG: FAR-3000, FAR-2××7, etc.).
- An antenna unit cannot be controlled from multiple display units. Select one Master display unit for one antenna unit. If two antenna units are set as masters, the display last-set as master becomes the master and all other displays are automatically changed to slave.
- An antenna unit without a Master display cannot be selected on the sub display units. If there is no antenna unit set as master, the lowest number display is automatically set as master.
- If the Alert "EXT RADAR ERROR" appears, do one of the following, as applicable:
 - If only your antenna is not displayed on the [ANT SELECT] display, the LAN line in the Processor Unit may be faulty. In this case, use the standalone mode.
 - If the antenna that was in use does not appear on the [ANT SELECT] display, the LAN line in other Processor Unit may be faulty. In this case, see the preceding page for how to select a different antenna unit
- When the Network fails, the Interswitch does not work, but standalone operation is possible.
- Radar functions are controlled independently, dependently or commonly depending on selection as [MASTER] or [SLAVE] (see the table on the following page).

Radar Functions	Control	Master Display Option	Slave Display Option
AIS function	Independent	Desired value can be set	Desired value can be set
Brilliance			
Echo trails			
EBL			
Lat/long data			
Presentation mode			
Speed data			
Target alarm			
TT, AIS on/off			
TT, AIS track interval			
Vector mode			
Vector time			
VRM			
Wiper			
Zoom			
TT COLLISION alarm			
Range* ² (Sampling at Master)	Independent	Desired value can be set (Echo Sampling at Master Range)	Desired value can be set
A/C SEA			
A/C RAIN			
Automatic Clutter Elimination (ACE)			
Gain			
IR* ¹	Dependent Control	Desired value can be set	Cannot control
Echo stretch	Independent	Desired value can be set	Desired value can be set
Echo averaging	Independent	Desired value can be set	Desired value can be set
Picture setting (Customize echo)	Dependent Control	Desired value can be set	Cannot control
STBY/TX			
Tuning			
Reference Point	Independent	Desired value can be set	Desired value can be set
TT LOST warning	Common Control	Item Commonly Controlled	Item Commonly Controlled
TT alerts ACK			
TT acquire			
TT/AIS AZ			
<p>*¹: When the connected radar antenna is a FAR-3xx0/FAR-2xx8 series magnetron-type, and the radar is assigned as "Slave", the desired value can be set for this functions. For FAR-3xx0/FAR-2xx8 series SSD-types, this functions cannot be controlled.</p> <p>*²: The desired value can be set when the radar is assigned as "Slave", however the maximum displayable range is dependent on the setting at the "Master" radar.</p>			

1.49.3 How to clear the interswitch

You can clear the interswitch settings by following the procedure below.

1. Open the menu.
2. Select [9 INITIAL SETTINGS].
3. Select [3 SELECT ANTENNA]. The [SELECT ANTENNA] menu appears.
4. Select [0 CLEAR INTER-SWITCH].
5. Select [YES] to clear the interswitch settings. The antenna settings are restored to default.

1.50 Performance Monitor

The performance monitor, installed in the antenna unit, produces a visual indication on the radar display screen when the radar transmitter power and radar receiver sensitivity are within the prescribed limits.

Note: The performance monitor and related features are not available from FAR-2x58 monitors which are assigned as [SUB] at installation.

1.50.1 How to activate/deactivate the performance monitor

1. Set the radar to TX (transmit) mode.
2. Open the menu.
3. Select [1 ECHO].
4. Select [5 PERFORMANCE MONITOR].
5. Select the appropriate setting, then press the **ENTER MARK** key.
 - [OFF]: Deactivate the performance monitor.

Note: You can also deactivate the performance monitor by adjusting the range manually.
 - [ON]: Activate the performance monitor and show the graph.
 - [GRAPH ONLY]: Show the performance monitor graph, however the performance monitor is not activated.
6. Close the menu.

When the performance monitor is active, the indication "PM" appears in yellow characters at the top of the display.

Note: If the blind sector and the direction of the PM antenna overlap one another, turn off the blind sector in order to display echoes correctly.

The radar is automatically set as follows when the performance monitor is activated.

Setting	Setting at PM activation	Adjustable while PM is active	Setting at PM deactivation
[GAIN]	70 *1	Yes *3	Setting before PM activation.
[SEA]	0	No	Setting before PM activation.
[SEA AUTO]	MAN	No	Setting before PM activation.
[RAIN]	0	No	Setting before PM activation.
<i>Table continued on the following page.</i>			

Setting	Setting at PM activation	Adjustable while PM is active	Setting at PM deactivation
<i>Table continued from the previous page.</i>			
[RAIN AUTO]	MAN	No	Setting before PM activation.
[TUNE] (Shown for magnetron radars only)	AUTO	No	Setting before PM activation.
[TX CH] (Shown instead of [TUNE] for solid-state radars only)	CH1	No	Setting before PM activation.
[ACE]	OFF	No	Setting before PM activation.
[ES]	OFF	No	Setting before PM activation.
[EAV]	OFF	No	Setting before PM activation.
[IR]	2	No	Setting before PM activation.
[NOISE REJECT]	OFF	No	Setting before PM activation.
[VIDEO CONTRAST]	4-B	No	Setting before PM activation.
[PULSE]	LONG	No	Setting before PM activation.
[2ND ECHO REJ]	OFF	Yes	Setting before PM activation.
[LOW LEVEL ECHO]	Previous setting kept, fixed.	No	Setting before PM activation.
[WIPER]	OFF	No	Setting before PM activation.
[CUSTOMIZED ECHO]	Previous setting kept, fixed.	No	Return to active display.
[PRESENTATION MODE]	No change. *2	Yes	Setting at PM deactivation.
[RANGE]	24 NM, 24 SM, 48 km, 48 kyd (Settings other than NM are available for C-types only.)	Yes *4	Setting before PM activation.
[OFF CENTER]	OFF	Yes	Setting at PM deactivation.
ANT REVOLUTION	24 rpm	No	Setting before PM activation.
<p>*1: Gain is automatically set according to [PM GAIN ADJ], if it was adjusted at installation. *2: [NORTH UP RM] is selected when the [PRESENTATION MODE] is set to [NORTH UP TM]. *3: The setting is not memorized. *4: The performance monitor is deactivated if the range is changed manually.</p>			

1.50.2 How to check the radar's performance



The range scale is automatically set to 24 NM. The radar screen will show arcs. If the radar transmitter and receiver are in good working conditions in as much as the original state when the monitor was turned on, the innermost arcs should appear between 8.0 NM to 19.8 NM. The performance monitor can observe a total of 10 dB loss in transmitter and receiver.

Note: The performance monitor and related features are not available from FAR-2x58 monitors which are assigned as [SUB] at installation.

How to set the number of arcs

1. Open the menu.
2. Select [1 ECHO].
3. Select [6 PM ARC].
4. Select [2], [3], [5] or [6] as appropriate, then press the **ENTER MARK** key.
5. Close the menu.

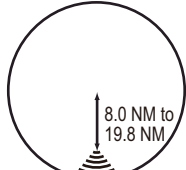
The figure belows shows an example where [PM ARC] is set to [5].

<u>Display</u>	<u>Radar State</u>	<u>Display</u>	<u>Radar State</u>
	<p>Transmitter: normal Receiver: normal</p>		<p>Transmitter and receiver: No arc indicates 10 dB loss. Contact your dealer for advice. (For magnetron radars, have a technician check the magnetron.)</p>

Note 1: The lengths of the arcs can vary according to installation environment. Judge the strength of the echo that appears within 60° from the arc location to confirm if the radar is working properly or not.

Note 2: The location of the arcs changes according to the [PM ARC] setting.

Turn the performance monitor off when finished.

1.51 How to Change the Reference Position

The reference position for measurements (range, bearing, etc.) and markers (heading line, stern mark, etc.) can be the radar antenna position ([ANT]) or the consistent common reference point ([CCRP]).

The reference position is a location on own ship to which all horizontal measurements, for example range, bearing, relative course, relative speed, closest point of approach (CPA) or time to closest point of approach (TCPA), are normally referenced.

[CCRP] for this series of radars is fixed at the conning position and [ANT] is fixed at the radar antenna position.

To change the reference position, use the trackball to place the cursor over the "REF POINT" indication at the top of the screen, then left-click to select [ANT] or [CCRP] as required. You can also change the reference by spinning the scrollwheel when the cursor is placed over the indication.

The position of the own ship marker changes according to reference position as shown below. If the CCRP is positioned outside of the effective display area, the bearing scale is indicated with the appropriate reduced detail.

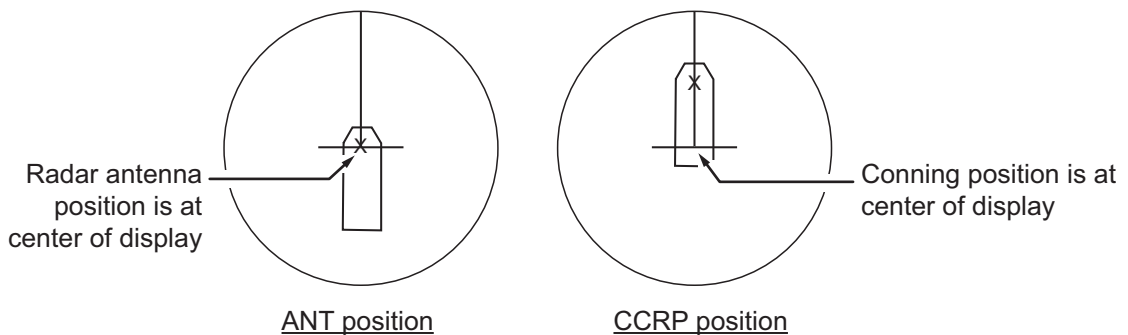

Range and bearing are measured and graphics are drawn according to reference position as in the table below.

Category	Item	Reference point	
		ANT	CCRP
Range and bearing measurements	EBL	Range and bearing measured from antenna position.	Range and bearing measured from CCRP.
	VRM		
	Cursor		
	PI line		
	Range ring		
	Drop mark		
Graphics	Heading line	Drawn from antenna position.	Drawn from CCRP.
	Stern mark		
	Beam line		
	Own ship vector		
	Own ship track		
Bearing cursor		Drawn with antenna position at center.	Drawn with CCRP at center.
Course, speed		Calculated with antenna position at center.	Calculated with CCRP at center.

Table continued on following page

Category	Item	Reference point	
		ANT	CCRP
<i>Table continued from previous page</i>			
CPA, TCPA		Calculated with antenna position at center.	Calculated with CCRP at center.
BCR, BCT		Calculated from bow position.	
Own ship data	Heading	Data is taken from respective sensors, regardless of reference point selected.	
	Speed		
	Course over ground		
	Speed over ground		
	Own L/L	Location of the CCRP.	

Note: When the antenna is located some distance from the CCRP, the CCRP can be outside the bearing cursor in true-motion or off-center. Also, when the CCRP is set as a reference point, some parts of the bearing cursor are not displayed.

1.52 Anchor Watch

The anchor watch feature alerts you when your ship has traveled a distance greater than a threshold value, when it should be at rest. When the anchor watch is active, an orange dashed circle marks the anchor watch range.

If your ship drifts more than the anchor watch setting, the alert "ANCHOR WATCH" appears in the [ALERT] box. The alert is escalated from warning level to alarm level if the alert is not acknowledged within one minute. Also, if your vessel returns to within the tolerable radius, the alert status is automatically changed to rectified.

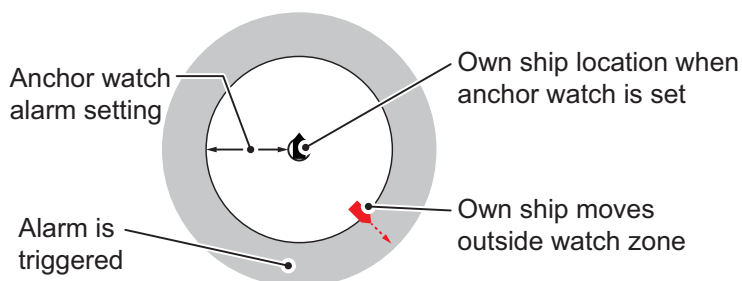

1. Open the menu.
2. Select [4 ALERTS].
3. Select [4 ANCHOR WATCH].
4. Select [ON] to enable [ANCHOR WATCH], then press the **ENTER MARK** key.
5. Spin the scrollwheel to set the distance for the alert. Press the **ENTER MARK** key to apply the setting.
6. Close the menu.

1.53 Alerts

1.53.1 What is an alert?

“Alert” is a generic name for a notice to any unusual or potentially dangerous situation generated within the system.

For detailed information regarding specific alerts and alert codes, including possible remedies, see "ALERT CODES, MESSAGES & MEANINGS" on page AP-17.

Alerts are classified according to priority and category.

Alert priority

The level of priority, from highest to lowest, is ALARM → WARNING → CAUTION.

Alarm: Situations or conditions which require immediate attention, decision and (if necessary) action by the bridge team to avoid any kind of hazardous situation and to maintain the safe navigation of the ship.

Warning: Conditions or situations which require immediate attention for precautionary reasons, to make the bridge team aware of conditions which are not immediately hazardous, but may become so.

Caution: Awareness of a condition which continues to require attention out of the ordinary consideration of the situation or of given information.

Note: All active-unacknowledged warnings, except ANCHOR WATCH, are repeated as warnings after 60 seconds (manufacturer’s fixed time period). The ANCHOR WATCH alert is escalated from warning level to alarm level if it is not acknowledged within 60 seconds.

Alert category

An alert is further classified by category, A, B or C, according to its degree of severity or source.

Category	Description
A	Category A alerts include alerts indicating <ul style="list-style-type: none"> • Danger of collision • Danger of grounding
B	Category B alerts are alerts where no additional information for decision support is necessary. Category B alerts are all alerts not falling under category A.
C	Engine-related alert

1.53.2 Alert box overview

When an alert condition is found, the applicable alert message appears in the [ALERT] box. A buzzer sounds for alarm and warning alerts.

Normal display mode (IMO/C-types)

The [ALERT] box is composed of three lines of text information, and several icons, as shown below.



Simple display mode (C-types only)

The icon for the highest priority alert appears at the bottom-right corner of the screen.



1.53.3 How to silence the buzzer

Place the cursor on the buzzer silence icon in the alert box, then left-click. The alert buzzer is temporarily silenced. When the buzzer is silenced, the alert status is also changed (see section 1.53.6).

Note: The buzzer silence box is not visible for C-types using [SIMPLE] display mode.

1.53.4 How to acknowledge an alert

You can acknowledged alerts with one of the following methods:

- Press the **ALARM ACK** (RCU-014) or **ALERT ACK** (RCU-031) key.
- Left-click the alert name in the alert box.
Note: The alert box is not visible for C-types using [SIMPLE] display mode.
- Left-click the alert icon (C-types using [SIMPLE] display mode only)
- Open the alert list and left-click the alert in the list.

When the buzzer is silenced, the alert status is also changed (see section 1.53.6).

1.53.5 Alert list

The alert list displays the names of violated alerts, including the time and date violated. Up to 100 alerts are stored in the internal memory. Unacknowledged alarms are displayed first in the list (in red text), in the order in which they appear in the [ALERT] box. Unacknowledged warnings are displayed in the list (in yellow-orange text), in the order in which they appear in the [ALERT] box.

Cautions are displayed in the list (in yellow text), in the order in which they appear in the [ALERT] box.

You can show the alert list with one of the following methods.

- **IMO/C-types using NORMAL display mode:** place the cursor on the alert list/log button in the [ALERT] box then left-click.
- **C-types using SIMPLE display mode:** place the cursor on the alert icon then left-click.

The screenshot shows the 'ALERT LIST (1/2)' screen. At the top, it says 'ALERT LIST (1/2)' and 'Displayed page/Pages available'. The list contains four entries:











1	BACK(L=TOP)		
2	194		23:15
	! MTR-DRV		03/FEB
	COM ERROR		RADAR1
3	52601		20:25
	! NO GYRO		01/FEB
	SIGNAL		RADAR1
4	52001		12:18
	! RPU:FAN2		01/FEB
	SPD ERROR		RADAR1
	9 REFRESH DATA(L=CLR)		
	0 NEXT(L=LAST)		

Annotations and actions:

- Alert code and alert message:** Points to the text '52601 NO GYRO SIGNAL' in row 3.
- Alert icon:** Points to the yellow exclamation mark icon in row 3.
- Displayed page/Pages available:** Points to '(1/2)' at the top.
- BACK(L=TOP):** - When selected at page 1, closes the list. - When selected at page 2 or later, goes back to the previous page. - Long-press the **left button** to go to page 1.
- RADAR1:** - Radar which output this alert
- Date and time of alert:** Points to '12:18 01/FEB' in row 4.
- 9 REFRESH DATA(L=CLR):** - Select to refresh the list. - Long-press the **left button** to remove acknowledged and rectified alerts from the list.
- 0 NEXT(L=LAST):** - Select to go to the next page. - Long-press the **left button** to go to the last page.

An unacknowledged alert can be acknowledged from the list by selecting it, then left-clicking. To erase the data for the number selected, left-click again. To erase all alert indications, select [9 REFRESH DATA], then press and hold the **left button**.

1.53.6 Alert icons and their meanings

Icon	Status	Visual indication	Audible alert
	Active - unacknowledged alarm	Red, flashing	3 short, audible alerts repeated every 7 seconds.
	Active - silenced alarm	Red, flashing	Silent
	Active - acknowledged alarm	Red	Silent
	Active - responsibility transferred alarm	Red	Silent
	Rectified - unacknowledged alarm	Red	Silent
	Active - unacknowledged warning	Yellow-orange, flashing	2 short, audible alerts repeated every 60 seconds.
	Active - silenced warning	Yellow-orange, flashing	Silent
	Active - acknowledged warning	Yellow-orange	Silent
	Active - responsibility transferred warning	Yellow-orange	Silent
	Rectified - unacknowledged warning	Yellow-orange	Silent
	Caution	Yellow	Silent

1.54 Icing Prevention

You can rotate the antenna (24 rpm) without transmission to keep the antenna from freezing.

1. Open the menu.
2. Select [9 INITIAL SETTINGS].
3. Select [5 OPERATION].
4. Select [7 ICING PREVENTION].
5. Select [ON] or [OFF] as appropriate. If you select [ON], the message "Rotate Antenna to Prevent Icing." appears at the bottom of the screen.
6. Click [Start Antenna Rotation] to rotate the antenna without transmission. The message changes to read "Antenna Rotating, No TX."

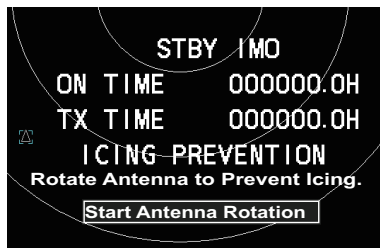

When the antenna stops

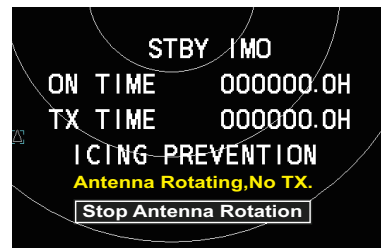

When the antenna rotates

To stop the antenna rotation, left-click [Stop Antenna Rotation].

With this feature active and the antenna stopped, pushing the **STBY TX** key on the Control Unit or click the [STBY TX] button on the Status bar rotates the antenna and transmits pulses. Operating one of the above-mentioned controls again stops transmission but the antenna rotates.

1.55 How to Select an Echo Display Area (C-type Only)

C-type radars of this series have three echo display modes available:

- [CIRCLE] mode: The echoes are displayed inside a circle on the screen. This is the default (IMO compliant) mode.
- [WIDE] mode: The echoes are displayed in a square area, but are not displayed in the data display area.
- [ALL] mode: The echoes are displayed across the entire screen.

Follow the procedure below to change display modes.

1. Open the menu.
2. Select [1 ECHO]. The [ECHO] menu appears.
3. Select [8 ECHO AREA].
4. Select the appropriate setting, then press the **ENTER MARK** key.

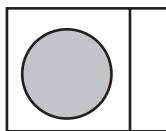

CIRCLE

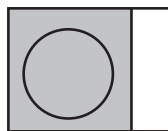

WIDE

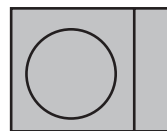

ALL

5. Close the menu.

1.56 How to Use the Watch Alert

The watch alert provides a visual alert at regular intervals to remind you to monitor the radar picture for safety or other purposes. When the watch alert is enabled, the WATCH box appears at the top of the screen.



When the timer reaches 00:00, an audible alert is released. To silence the buzzer, click the watch box. The timer is reset and begins to countdown again. You can reset the timer at any time by clicking the watch box.

To enable or disable the watch alert, follow the procedure below.

1. Open the menu.
2. Select [4 ALERTS]. The [ALERTS] menu appears.
3. Select [2 WATCH ALERT].
4. Select the [OFF] to disable the alert, or select the required interval at which the alert is released.
The available intervals are: [6min], [10min], [12min], [15min] and [20min].
5. Close the menu.
6. Left-click the watch box to start the watch timer. You can also reset the countdown by left-clicking the watch box at any time.

1.57 Loran Decca Setup (C-types Only)

When using Loran A time offset

1. Open the menu.
2. Select [9 INITIAL SETTINGS].
3. Select [9 LORAN•DECCA].
The [LORAN•DECCA] menu appears.
4. Select [3 LORAN/DECCA SELECT].
5. Select [LORAN A].
6. Select [2 LORAN•DECCA SETTING]. The setting window appears.

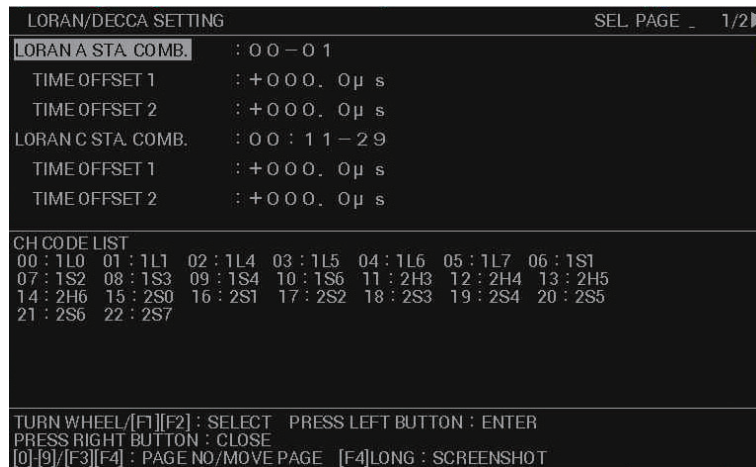

Note: There are two pages for the [LORAN/DECCA SETTING] menu. If page 2 appears, press the **F3** key to go back to page 1.

7. Select [LORAN A STA. COMB.], then press the **left button**.
8. Set the station combination referring to the [CH CODE LIST] in the lower half of the window.
9. Select [TIME OFFSET 1].
10. Rotate the **scrollwheel** and press the **left button** to set the time offset value.
11. Select [TIME OFFSET 2].
12. Rotate the **scrollwheel** and press the **left button** to set the time offset value.
13. Close the menu.

When using Loran C time offset

1. Open the menu.
2. Select [9 INITIAL SETTINGS].
3. Select [9 LORAN•DECCA].
4. Select [3 LORAN/DECCA SELECT].
5. Select [LORAN C].
6. Select [2 LORAN•DECCA SETTING]. The setting window appears.

Note: There are two pages for the [LORAN/DECCA SETTING] menu. If page 2 appears, press the **F3** key to go back to page 1.

7. Select [LORAN C].

1. OPERATIONAL OVERVIEW

8. Set the station combination referring to the [CH CODE LIST] in the lower half of the window.
9. Select [TIME OFFSET 1].
10. Rotate the **scrollwheel** and press the **left button** to set the time offset value.
11. Select [TIME OFFSET 2].
12. Rotate the **scrollwheel** and press the **left button** to set the time offset value.
13. Close the menu.

When using Decca chain offset

1. Open the menu.
2. Select [9 INITIAL SETTINGS].
3. Select [9 LORAN•DECCA].
4. Select [3 LORAN/DECCA SELECT].
5. Select [DECCA].
6. Select [2 LORAN•DECCA SETTING]. The setting window appears.
Note: There are two pages for the [LORAN/DECCA SETTING] menu. If page 2 appears, skip to step 8.
7. Press the **F4** key to show the second page of the setting window.

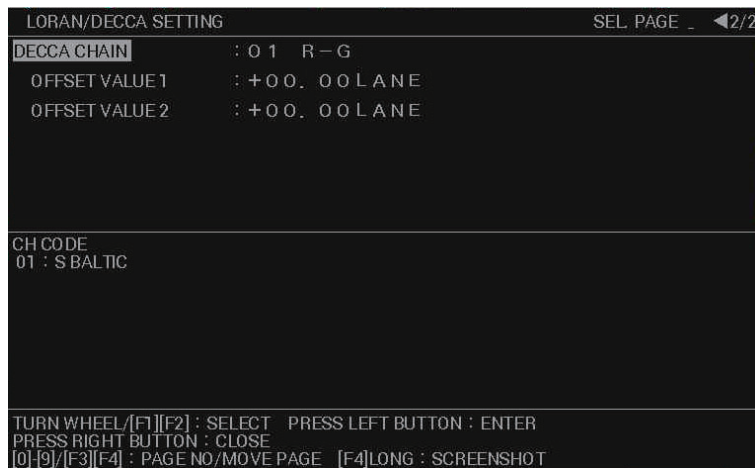

8. Select [DECCA CHAIN].
9. Set the station combination referring to the [CH CODE] in the lower half of the window.
10. Select [OFFSET VALUE 1].
11. Rotate the **scrollwheel** and press the **left button** to set the time offset value.
12. Select [TIME OFFSET 2].
13. Rotate the **scrollwheel** and press the **left button** to set the time offset value.
14. Close the menu.

1.58 How to Manage SD Card Data

For **IMO-types**, the following data can be stored on a SD Card: map marks/lines, user settings, installation settings, own track, alert history and some logs (for example, the alert log).



For C-types, the SD Card is used to store screenshots (see section 1.61).

Note: The procedures and operations outlined in this section are only available when a SD Card is inserted. When there is no SD Card inserted, the operations and procedures are not available. SD Cards must be formatted as FAT32. Other formats are not usable.

1.58.1 Formatting the SD card

You do not normally need to format a SD card. If the card becomes unreadable, format the card with a formatting program that is compatible with the specifications of the card.

1.58.2 Cautionary notes on handling SD cards

- Handle the cards carefully. Improper use can damage the card and destroy its contents.
- Make sure the card slot cover is closed, unless removing/inserting a card.
- Remove or insert a card using only your fingers. Do not use metal instruments (such as tweezers) to remove the card.
- Do not remove the card when data is loading from, or saving to, the card.

1.58.3 Compatible SD cards

The table below lists the micro SD cards that have been verified as compatible for use with this equipment.

Note 1: The cards were verified using basic functions. All functions were not verified. FURUNO does not guarantee card operations.

Note 2: SD cards other than those listed below have not been verified.

Maker	SD card type	Capacity
Panasonic	RP-SDUC16GJK	16GB
	RP-SDUC32GJK	32GB
	RP-SDWA16GJK	16GB
	RP-SDWA-32GJK	32GB
SanDisk	SDSDB-016G-J35U	16GB
	SDSDC-032G-J35U	32GB
	SDSDXPA-016G-JU3	16GB
	SDSDXPA-032G-JU3	32GB
	SDSDXVE-032GB-JNJIP	32GB
Toshiba	SDAR40N16G	16GB
	SDAR40N32G	32GB
	SD-L016G4	16GB
	SD-L032G4	32GB
	SDXU-B016G	16GB
	SDXU-B032G	32GB

1.58.4 How to insert SD cards

The SD card slot is located on the front face of the processor unit, between the LAN1 port and the DVI-I port.

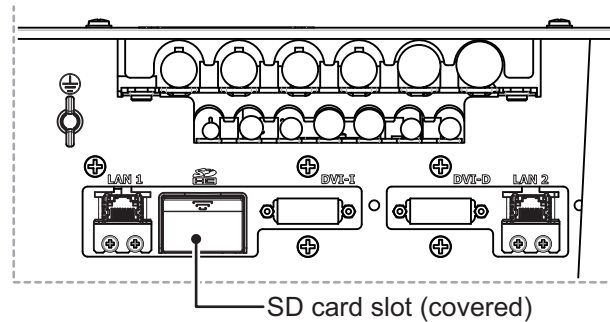

Note: Do not use any instruments to insert the card.

1. Remove the rubber cover on the SD card slot.
2. To insert a card, gently push the card into the slot, making sure that the card connectors are facing downwards.
3. Close the rubber cover.

1.58.5 How to remove SD cards

Follow the procedure below to safely remove an SD card.

Note 1: When the system power is turned off, skip steps 1 to 3.

Note 2: Do not use any instruments/tools top insert or remove the SD card.

1. Open the menu.
2. Select [6 FILES]. The [FILES] menu appears.



IMO-types

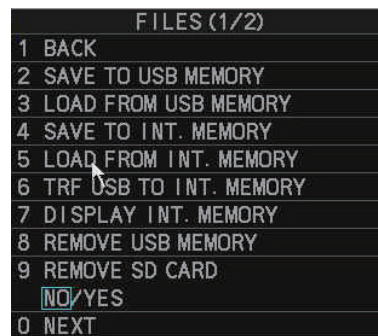

C-types

3. **For IMO-types**, select [REMOVE EXT MEDIA], then select [YES].
For C-types, select [REMOVE SD CARD], then select [YES].
You can now remove the SD card safely.
4. Remove the rubber cover on the SD card slot.
5. Gently push the SD cards to release the card from the card slot.
6. Remove the SD card. Do not use any instruments to remove the card.
7. Close the menu.

1.58.6 How to save data to an SD card (IMO-types only)

1. Open the menu.
2. Select [6 FILES]. The [FILES] menu appears.
3. Select [2 SAVE DATA].
4. Select the data to save, then press the **ENTER MARK** key.
The software keyboard appears.
5. Using the software keyboard, name the file, then select [END] to start saving data.

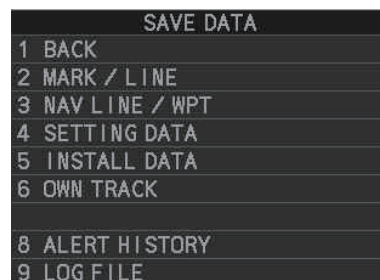

Note: Depending on the data saved, the first letter of the filename is preset and cannot be changed. The presets are listed below.

- Marks/Lines: M
- Nav lines/Waypoints: W
- Setting data: S
- Install data: I
- Own track: T
- Alert history: H
- Log file: L

The indication "WR CARD DATA" appears during the save process and the menu closes automatically.

6. When the process is complete, the indication "COMPLETED" appears on the screen.

1.58.7 How to read (load) data from an SD card (IMO-types only)

1. Open the menu.
2. Select [6 FILES]. The [FILES] menu appears.
3. Select [3 LOAD DATA].
4. Select the data to load, then press the **ENTER MARK** key.
The indication "RD CARD DATA" appears during the read process and the menu closes automatically.

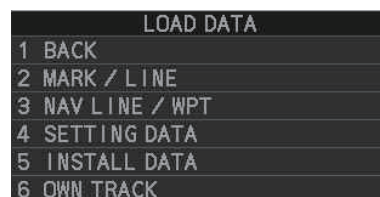

5. When the process is complete, the indication "COMPLETED" appears on the screen.

1.58.8 How to delete data from an SD card (IMO-types only)

1. Open the menu.
2. Select [6 FILES]. The [FILES] menu appears.
3. Select [4 DELETE DATA].
4. Select the data to delete, then press the **ENTER MARK** key.
The indication "DELETE CARD DATA" appears during the delete process.
5. Close the menu.

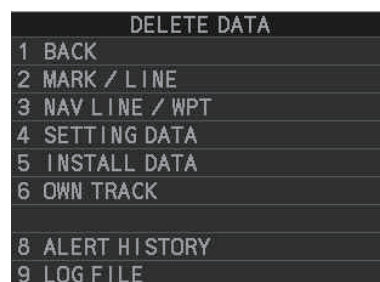

1.59 Internal Memory (C-types only)

The system's internal memory stores data such as own track, other ship's track, marks, lines, routes, waypoints and some settings. When the temporary memory becomes full, the oldest data are deleted and the newest data is stored. You can save data to a USB flash memory, or to the internal memory. The process of saving and loading data uses internal, temporary and USB flash memory in the following manner.

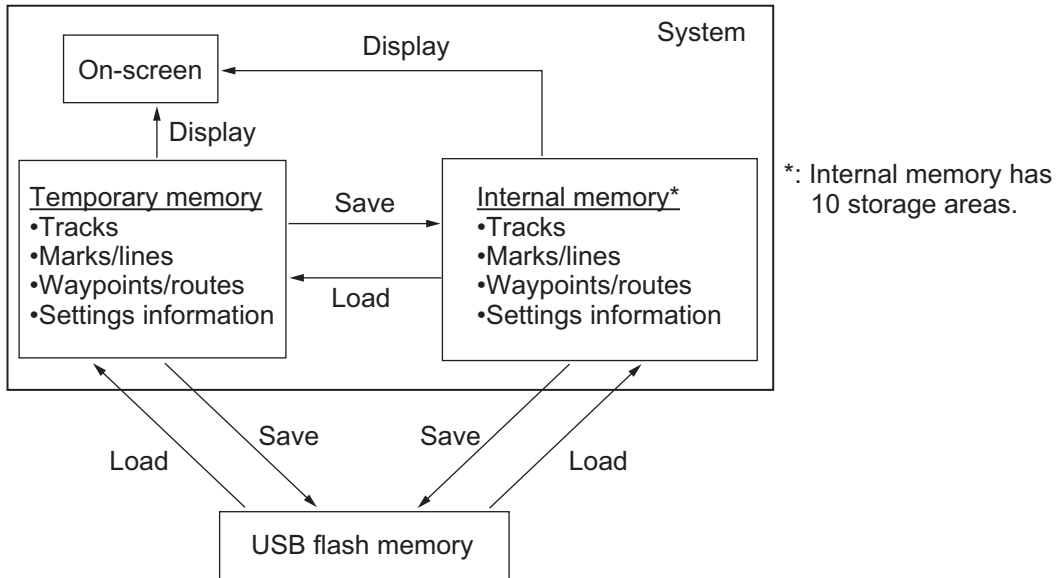

Note: The procedures in this section must be done with the radar in STBY. If the radar is set to transmit, the [FILES] menu is not available.

1.59.1 How to save data to the internal memory

You can save data from the temporary memory to the internal memory. The internal memory has 10 storage areas and each area has the following storage capacity.

- Own ship tracks: 30,000
- Marks/lines: 30,000
- Waypoints: 3,500
- Routes: 200
- Area marks: 50
- Other tracks: 40,000, comprised of:
 Consort vessels: 10,000;
 AIS targets: 10,000;
 TT targets: 10,000;
 GPS buoys: 10,000.

1. Open the menu.
2. Select [6 FILES]. The [FILES] menu appears.

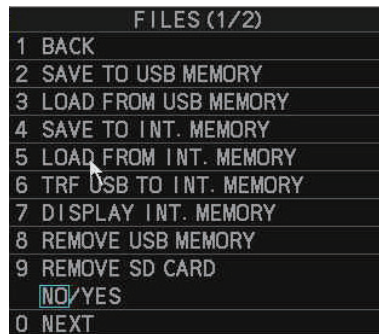

3. Select [4 SAVE TO INT. MEMORY]. The [INTERNAL MEMORY RECORDING] window appears.

INTERNAL MEMORY RECORDING					
REC OWN TRK	:	YES		<input type="button" value="NO"/>	
REC OTHER TRK	:	YES		<input type="button" value="NO"/>	
RECORD MARK/TRACK	:	YES		<input type="button" value="NO"/>	
RECORD ROUTE/WPT	:	YES		<input type="button" value="NO"/>	
DOWNLOAD SETTING	:	YES		<input type="button" value="NO"/>	
DATA SELECTION					
DATA	OWN TRK	OTR TRK	MARK	WPT	ROUTE
1:NO DATA					
2:NO DATA					
3:NO DATA					
4:NO DATA					
5:NO DATA					
6:NO DATA					
7:NO DATA					
8:NO DATA					
9:NO DATA					
0:NO DATA					
CURRENT USAGE	OWN TRK	:	2154	/30000	
	OTHER TRK (CONS)	:	0	/10000	
	OTHER TRK (AIS)	:	2358	/10000	
	OTHER TRK (TT)	:	0	/100000	
	OTHER TRK (GPS BUOY)	:	0	/10000	
	MARK/LINE	:	30	/30050	
TURN WHEEL/[F1][F2] : SELECT PRESS LEFT BUTTON : ENTER					
PRESS RIGHT BUTTON : CLOSE					
SELECT THE FILE TO RECORD					
[F4]LONG : SCREENSHOT					

4. Select an item, then select [YES] to save the item to the internal memory.
5. To save other items, repeat step 4 as required.
6. Select an area to save the data. A pop up window appears showing the file name for the saved data. The default name is the date and time at which the data was saved.
7. **To change the filename**, go to the next step.
To keep the default filename, close the menu.
8. Referring to section 1.5.3, enter the desired filename. A confirmation message appears.

	RECORD CURRENT DATA TO INTERNAL MEMORY. ARE YOU SURE?
	<input type="button" value="RUN"/> <input type="button" value="CANCEL"/>
PRESS LEFT BUTTON : ENTER	
[F4]LONG : SCREENSHOT	
TURN WHEEL/[F1][F2] : SELECT	

9. Select [ENTER] to save the data, or select [CANCEL] to cancel the procedure. If you selected [ENTER], a progress window appears to show the save progress. When the save is completed, a message appears.
10. Select [OK].
11. Close the menu.

1.59.2 How to view the contents of the internal memory

You can view (replay) items stored in the internal memory.

1. Open the menu.
2. Select [6 FILES]. The [FILES] menu appears.
3. Select [7 DISPLAY INT. MEMORY]. The [DISPLAY INTERNAL MEMORY] window appears.

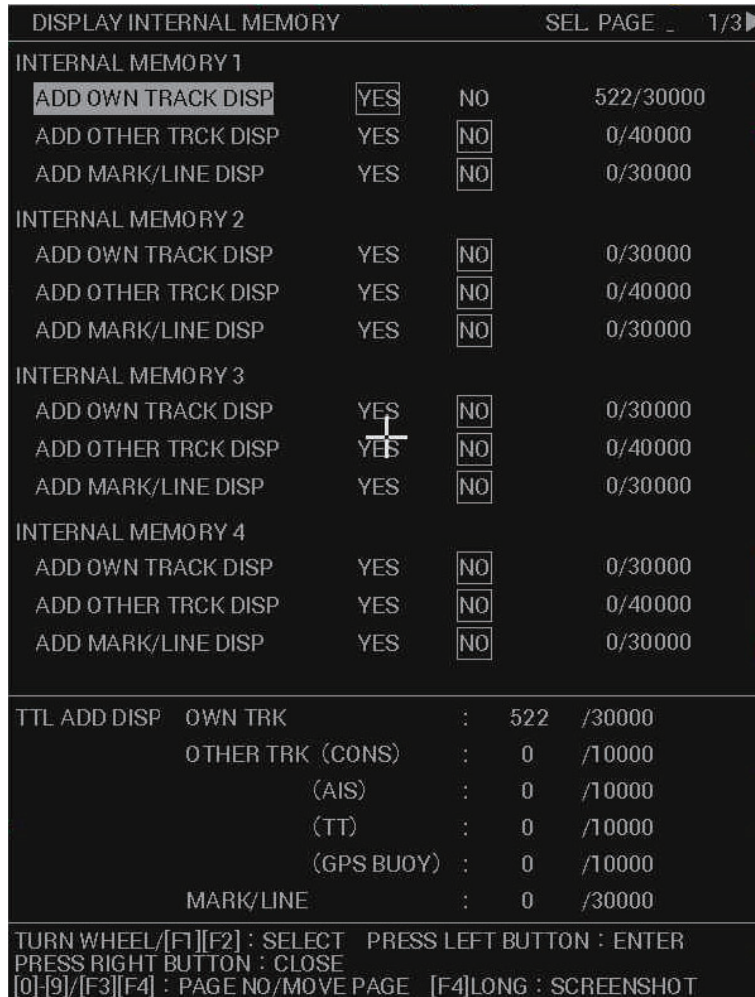

The internal memory areas (1 through 10) appear across three pages. Press **F3** or **F4** to change pages.

4. Select the items whose contents you want to view, then select [YES].
5. Repeat step 4 to add other items you want to view.

Note: The total number of selected items appears at the bottom of the window. If the selected number exceeds the maximum, the indication appears in yellow color and items which are in excess of the maximum are not displayed.
6. Close the window.

The items you selected to view appear on the screen. Displayed tracks, marks and lines cannot be edited or deleted, as this feature only displays these items.

To remove the stored items from the screen, repeat the above procedure, then select [NO] at step 4.

1.59.3 How to load the contents of the internal memory

You can load the data from the internal memory, however, this procedure replaces the temporary memory contents with the contents of the internal memory. If you want to keep the contents of the internal memory, save the contents before continuing with this procedure.

1. Open the menu.
2. Select [6 FILES]. The [FILES] menu appears.
3. Select [5 LOAD FROM INT. MEMORY]. The [INTERNAL MEMORY PLAYBACK] window appears.

INTERNAL MEMORY PLAYBACK					
PLAY OWN TRK	:	ADD			<input type="checkbox"/> NO
PLAY OTHER TRK	:	ADD			<input type="checkbox"/> NO
PLAY MARK/TRACK	:	OVERWRITE	ADD		<input type="checkbox"/> NO
PLAY ROUTE/WPT	:	OVERWRITE			<input type="checkbox"/> NO
UPLOAD SETTING	:	OVERWRITE			<input type="checkbox"/> NO
DATA SELECTION					
DATA	OWN TRK	OTR TRK	MARK	WPT	ROUTE
CURRENT USAGE	OWN TRK	:	2197	/30000	
	OTHER TRK (CONS)	:	0	/10000	
	OTHER TRK (AIS)	:	2358	/10000	
	OTHER TRK (TT)	:	0	/100000	
	OTHER TRK (GPS BUOY)	:	0	/10000	
	MARK/LINE	:	30	/30050	
TURN WHEEL/[F1][F2] : SELECT PRESS LEFT BUTTON : ENTER					
PRESS RIGHT BUTTON : CLOSE					
SELECT THE FILE TO PLAY BACK					
[F4]LONG : SCREENSHOT					

4. Select the item you want to load.
5. Depending on the item selected at step 4, select [ADD], [OVERWRITE] or [NO] as appropriate.
 - [ADD]: selected data is added to the temporary data. Temporary data is not overwritten.
 - [OVERWRITE]: replace (overwrite) the temporary data with the selected data.
 - [NO]: selected data is not used.

Note 1: When [ADD] is selected for [PLAY MARK/TRACK], a limit of 30,050 items applies. When this limit is reached, no more items can be added.

Note 2: When [ADD] is selected for [PLAY OWN TRK] or [PLAY OTHER TRK] and the limit is reached, the oldest items are deleted to make way for new items. For example, if you have 10,000 tracks already saved and add 25,000, the oldest 5,000 tracks from those already saved are deleted.

1. OPERATIONAL OVERVIEW

- Repeat steps 4 and 5 to add other items you want to load.
- Select the data to load from the [DATA SELECTION] list. A confirmation message appears.

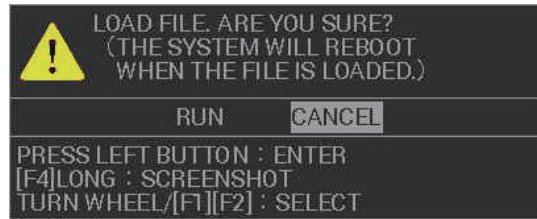

- Select [YES] to load the selected data, or select [CANCEL] to cancel the load. If you selected [YES], a progress bar appears to indicate the loading status, followed by a confirmation message when the loading is complete.
- Select [CONFIRM].
- Close the window.

1.59.4 How to delete the contents of the internal memory

You can delete the contents of each internal memory area.

- Open the menu.
- Select [6 FILES]. The [FILES] menu appears.
- Select [0 NEXT] to show the second page of the [FILES] menu.



- Select [5 DELETE INT. MEMORY]. The internal memory areas appear in a two-page menu.

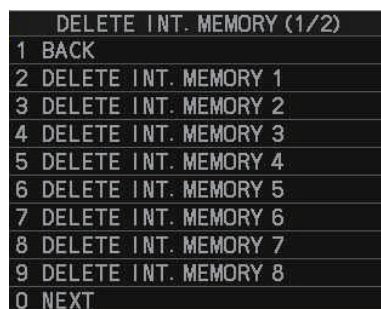

Page 1

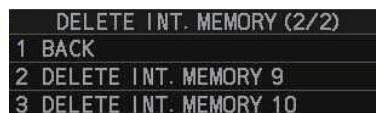

Page 2

- Select the internal memory area you want to delete. A confirmation message appears.



6. Select [RUN] to delete the area, or [CANCEL] to cancel the deletion.
If you selected [RUN], the message "PROCESSING. PLEASE WAIT" appears in a window while the memory is deleted. The message disappears when the delete process is complete.
7. Close the menu.

1.59.5 How to backup data in the internal memory

Data can be automatically backed up when the system starts up, or you can manually back up your data at any time.

Note: For automatic backups, the system start-up will take a short while longer than normal, to allow for the data backup.

How to automatically backup your data

1. Open the menu.
2. Select [6 FILES]. The [FILES] menu appears.
3. Select [0 NEXT] to show the second page of the [FILES] menu.
4. Select [2 AUTO BACKUP].

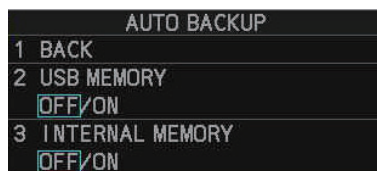

5. Select [3 INTERNAL MEMORY].
6. Select [ON] to activate, or [OFF] to deactivate, the automatic backup.
If you selected [ON], the internal memory is backed up each time you turn the system on.
7. Close the menu.

Note: When auto backup is activated, the system starts the backup process after the start-up warning screen is closed. A message appears while the backup is in progress and the message disappears when the backup is complete.

How to manually backup your data

1. Open the menu.
2. Select [6 FILES]. The [FILES] menu appears.
3. Select [0 NEXT] to show the second page of the [FILES] menu.
4. Select [3 SAVE BACKUP DATA].

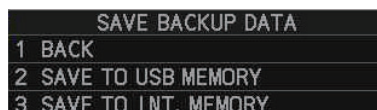

1. OPERATIONAL OVERVIEW

5. Select [3 SAVE TO INT. MEMORY]. A confirmation message appears.

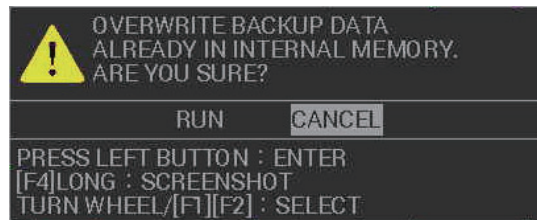

6. Select [RUN] to backup the area, or [CANCEL] to cancel the backup. If you selected [RUN], the message "TRANSFERRING. PLEASE WAIT" appears in a window while the data is backed up and a progress bar indicates the backup progress. The message changes to "TRANSFER COMPLETED" when the backup is completed.
7. Select [CONFIRM] to close the window.

1.59.6 How to load backup data from the internal memory

1. Open the menu.
2. Select [6 FILES]. The [FILES] menu appears.
3. Select [0 NEXT] to show the second page of the [FILES] menu.
4. Select [4 LOAD BACKUP DATA].

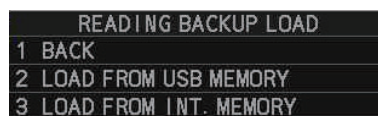

5. Select [3 LOAD FROM INT. MEMORY]. A confirmation message appears.

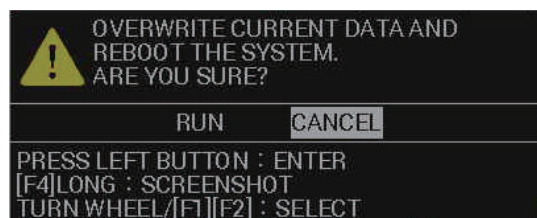

6. Select [RUN] to backup the area, or [CANCEL] to cancel the backup. If you selected [RUN], a progress window appears. When the data load is complete, the system restarts automatically.

1.60 USB Flash Memory (C-types only)

Note 1: This equipment is compatible with USB2.0.

Note 2: The procedures in this section must be done with the radar in STBY. If the radar is set to transmit, the [FILES] menu is not available.

1.60.1 USB Flash memory connection

Connect your flash memory to the USB port on the processor unit.

Note: The following figure is for explanatory purposes, with the cover of the processor unit removed. There is no need to remove the cover when connecting a flash memory.

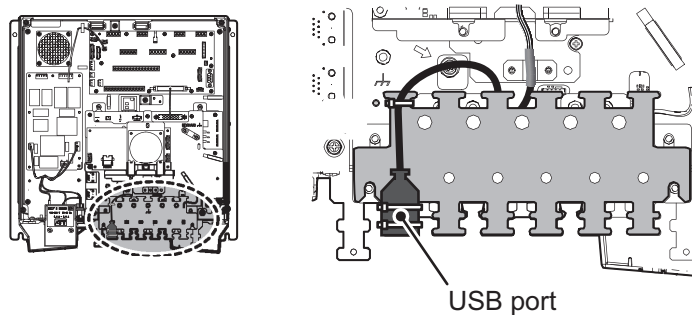

1.60.2 How to remove the USB flash memory safely

⚠ CAUTION

When removing the USB flash memory, only use the method described in this section.

Use of any other method may result in malfunction or incorrect operation of the USB and/or this equipment.

Note: If this equipment is turned off, steps 1 through 4 (menu operations) are not required.

1. Open the menu.
2. Select [6 FILES]. The [FILES] menu appears.
3. Select [8 REMOVE USB MEMORY]. A confirmation message appears.

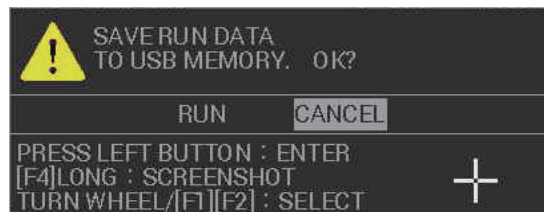

4. Select [CONFIRM].
5. Remove the USB flash memory from the processor unit.

- Referring to section 1.5.3, enter the desired filename. A confirmation message, similar to the one below, appears.



- Select [ENTER] to save the data, or select [CANCEL] to cancel the procedure. If you selected [ENTER], a progress window appears to show the save progress. When the save is completed, a message appears.
- Select [CONFIRM].
- Close the menu.

1.60.4 How to load data from the USB memory

You can load the data from the USB flash memory, however, this procedure replaces the temporary memory contents with the contents of the USB flash memory. If you want to keep the contents of the internal memory, save the contents before continuing with this procedure.

- Open the menu.
- Select [6 FILES]. The [FILES] menu appears.
- Select [5 LOAD FROM INT. MEMORY]. The [INTERNAL MEMORY PLAYBACK] window appears.

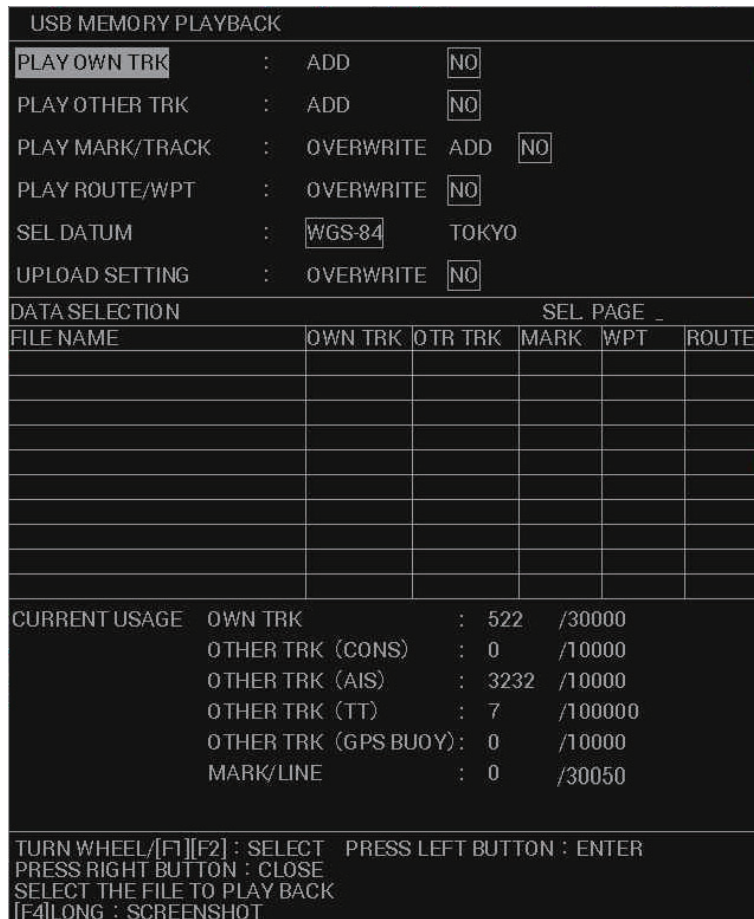

1. OPERATIONAL OVERVIEW

4. Select the item you want to load from the [DATA SELECTION] section of the window.
Note: If you are loading multiple items, load the settings information before any other data. If settings information is loaded together with other data, some, or all, of the non-settings data may not load correctly.
5. Depending on the item selected at step 4, select [ADD], [OVERWRITE] or [NO] as appropriate.
 - [ADD]: selected data is added to the temporary data. Temporary data is not overwritten.
 - [OVERWRITE]: replace (overwrite) the temporary data with the selected data.
 - [NO]: selected data is not used.

Note 1: When [ADD] is selected for [PLAY MARK/TRACK], a limit of 30,000 items applies. When this limit is reached, no more items can be added.

Note 2: When [ADD] is selected for [PLAY OWN TRK] or [PLAY OTHER TRK] and the limit is reached, the oldest items are deleted to make way for new items. For example, if you have 10,000 tracks already saved and add 25,000, the oldest 5,000 tracks from those already saved are deleted.
6. Repeat steps 4 and 5 to add other items you want to load.
7. Select [SEL DATUM].
8. Select [WGS-48] or [TOKYO] as required.
9. Select the data to load from the [DATA SELECTION] list. A confirmation message appears.
10. Select [YES] to load the selected data, or select [CANCEL] to cancel the load. If you selected [YES], a progress bar appears to indicate the loading status, followed by a confirmation message when the loading is complete.
11. Select [CONFIRM].
12. Close the window.

1.60.6 How to save the backup data to the USB flash memory

Data can be automatically backed up when the system starts up, or you can manually back up your data at any time.

Note: For automatic backups, the system start-up will take a short while longer than normal, to allow for the data backup.

How to automatically backup your data to the USB flash memory

1. Open the menu.
2. Select [6 FILES]. The [FILES] menu appears.
3. Select [0 NEXT] to show the second page of the [FILES] menu.
4. Select [2 AUTO BACKUP].

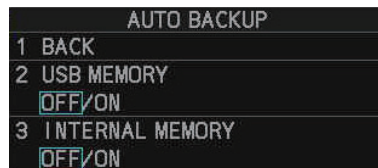

5. Select [2 USB MEMORY].
6. Select [ON] to activate, or [OFF] to deactivate, the automatic backup. If you selected [ON], the internal memory is backed up each time you turn the system on.
7. Close the menu.

Note: When auto backup is activated, the system starts the backup process after the start-up warning screen is closed. A message appears while the backup is in progress and the message disappears when the backup is complete.

How to manually backup your data to the USB flash memory

1. Open the menu.
2. Select [6 FILES]. The [FILES] menu appears.
3. Select [0 NEXT] to show the second page of the [FILES] menu.
4. Select [3 SAVE BACKUP DATA].
5. Select [2 SAVE TO USB MEMORY]. A confirmation message appears.
6. Select [RUN] to backup the area, or [CANCEL] to cancel the backup. If you selected [RUN], the message "TRANSFERRING. PLEASE WAIT" appears in a window while the data is backed up and a progress bar indicates the backup progress. The message changes to "TRANSFER COMPLETED" when the backup is completed.
7. Select [CONFIRM] to close the window.

1.60.7 How to load backup data from the USB flash memory

1. Open the menu.
2. Select [6 FILES]. The [FILES] menu appears.
3. Select [0 NEXT] to show the second page of the [FILES] menu.
4. Select [4 LOAD BACKUP DATA].
5. Select [2 LOAD FROM USB MEMORY]. A confirmation message appears.
6. Select [RUN] to backup the area, or [CANCEL] to cancel the backup.
If you selected [RUN], a progress window appears. When the data load is complete, the system restarts automatically.

1.60.8 How to import data from other equipment

You can import data from other compatible equipment into the internal memory.

Note: Before importing data, consult your local dealer.

1. Connect the USB with the data you want to import to the USB port on the processor unit.
2. Open the menu.
3. Select [6 FILES]. The [FILES] menu appears.
4. Select [0 NEXT] to show the second page of the [FILES] menu.
5. Select [6 RELAY DATA]. The [RELAY DATA] menu appears.

RELAY DATA (1/2)	
1	BACK
3	GP-3700
4	FAR-14x7
5	FAR-21x7
6	FAR-14x6
7	GP-3500
8	GD-X80(CARD)
9	GP-3000 SERIES
0	NEXT

Page 1

Menu item [8 GD-X80]
covers GD-280,
GD-380, GD-680 and
GD-280BB.

RELAY DATA (2/2)	
1	BACK
3	GD-188(CARD)

Page 2

1.61 How to Take a Screenshot

The system has an in-built screenshot feature. To use the feature, a SD Card must be inserted in the Processor Unit. If there is no card inserted, the screenshot button on the screen is not active.

To take a screenshot of the currently displayed screen, click the screenshot button.

Note: The screenshot function can also be assigned to a function key. For how to set up the function keys, see section 1.8

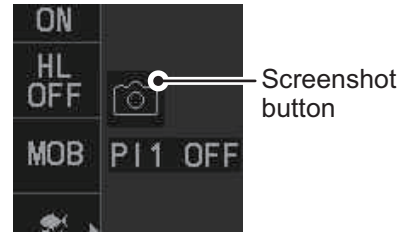

1. OPERATIONAL OVERVIEW

This page is intentionally left blank.

2. RADAR OBSERVATION

2.1 General

2.1.1 Minimum range

The minimum range is defined by the shortest distance at which, using a scale of 1.5 or 0.75 nm, a target having an echoing area of 10 m² is still shown separate from the point representing the antenna position.

It is mainly dependent on the pulselength, antenna height, and signal processing such as main bang reduction and digital quantization. It is a good practice to use a shorter range scale as far as it gives favorable definition or clarity of picture.

The IMO Resolution MSC.192(79) requires the minimum range to be less than 40 m, respectively. This series of radars satisfy this requirement.

2.1.2 Maximum range

The maximum detecting range of the radar, R_{max}, varies considerably depending on several factors such as the height of the antenna above the waterline, the height of the target above the sea, the size, shape and material of the target, and the atmospheric conditions.

Under normal atmospheric conditions, the maximum range is equal to the radar horizon or a little shorter. The radar horizon is longer than the optical one by about 6% because of the diffraction property of the radar signal. The R_{max} is given in the following equation.

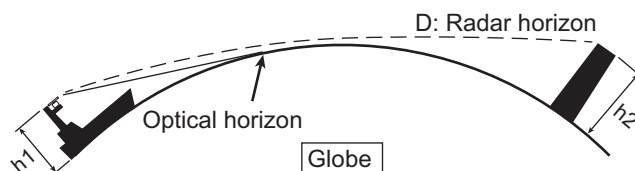

$$D = 2.2 \times (\sqrt{h_1} + \sqrt{h_2})$$

where D: radar horizon (nautical miles)

h₁: antenna height (m)

h₂: target height (m)

For example, if the height of the antenna above the waterline is 9 meters and the height of the target is 16 meters, the maximum radar range is;

$$R_{\max} = 2.2 \times (\sqrt{9} + \sqrt{16}) = 2.2 \times (3 + 4) = 15.4 \text{ nm}$$

It should be noted that the detection range is reduced by precipitation (which absorbs the radar signal).

2.1.3 X-band and S-band

In fair weather, the equation on the previous page does not give a significant difference between X- and S-band radars. However, in heavy precipitation condition, an S-band radar would have better detection than an X-band radar.

2.1.4 Radar resolution

There are two important factors in radar resolution (discrimination): bearing resolution and range resolution.

- Bearing resolution is the ability of the radar to display as separate pips the echoes received from two targets that are at the same range and close together. It is proportional to the antenna length and reciprocally proportional to the wavelength. The length of the antenna radiator should be selected for a bearing resolution better than 2.5° (IMO Resolution). This condition is normally satisfied with a radiator of 1.2 m (4 ft) or longer in the X-band. The S-band radar requires a radiator of about 12 feet (3.6 m) or longer.

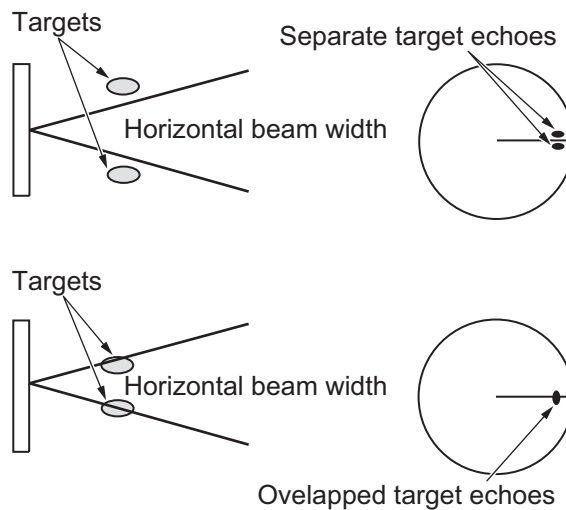

- Range resolution is the ability to display as separate pips the echoes received from two targets that are on the same bearing and close to each other. This is determined by pulselength only. Practically, a 0.08 microsecond pulse offers the discrimination better than 40 m as do so with all FURUNO radars. Test targets for determining the range and bearing resolution are radar reflectors having an echoing area of 10 m^2 .

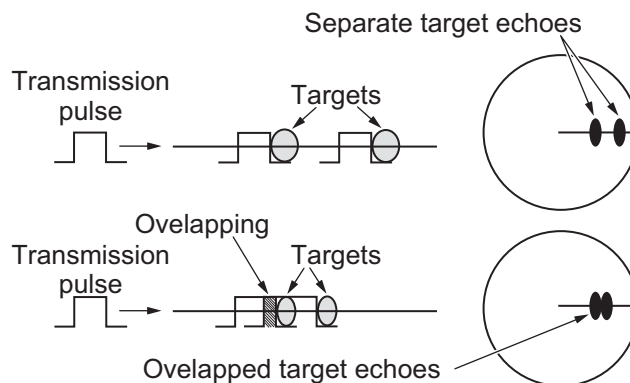

2.1.5 Bearing accuracy

One of the most important features of the radar is how accurately the bearing of a target can be measured. The accuracy of bearing measurement basically depends on the narrowness of the radar beam. However, the bearing is usually taken relative to the ship's heading, and thus, proper adjustment of the heading line at installation is an important factor in ensuring bearing accuracy. To minimize error when measuring the bearing of a target, put the target echo at the extreme position on the screen by selecting a suitable range.

2.1.6 Range measurement

Measurement of the range to a target is also a very important function of the radar. Generally, there are two means of measuring range: the fixed range rings and the variable range marker (VRM). The fixed range rings appear on the screen with a predetermined interval and provide a rough estimate of the range to a target. The variable range marker's diameter is increased or decreased so that the marker touches the inner edge of the target, allowing the operator to obtain more accurate range measurements.

2.2 False Echoes

Occasionally echo signals appear on the screen at positions where there is no target or disappear even if there are targets. They are, however, recognized if you understand the reason why they are displayed. Typical false echoes are shown below.

Multiple echoes

Multiple echoes occur when a transmitted pulse returns from a solid object like a large ship, bridge, or breakwater. A second, a third or more echoes may be observed on the display at double, triple or other multiples of the actual range of the target as shown below. Multiple reflection echoes can be reduced and often removed by decreasing the gain (sensitivity) or properly adjusting the A/C SEA control.

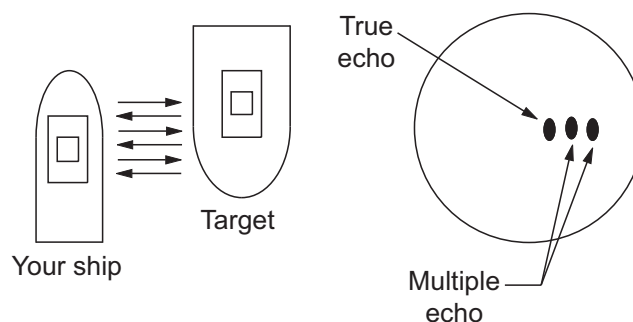

2. RADAR OBSERVATION

Sidelobe echoes

Every time the radar pulse is transmitted, some radiation escapes on each side of the beam, called "sidelobes". If a target exists where it can be detected by the side lobes as well as the main lobe, the side echoes may be represented on both sides of the true echo at the same range. Side lobes show usually only on short ranges and from strong targets. They can be reduced through careful reduction of the gain or proper adjustment of the A/C SEA control.

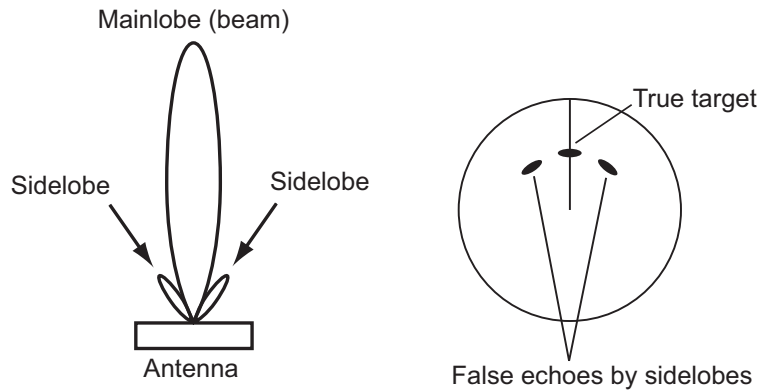

Virtual image

A relatively large target close to your ship may be represented at two positions on the screen. One of them is the true echo directly reflected by the target and the other is a false echo which is caused by the mirror effect of a large object on or close to your ship as shown in the figure below. If your ship comes close to a large metal bridge, for example, such a false echo may temporarily be seen on the screen.

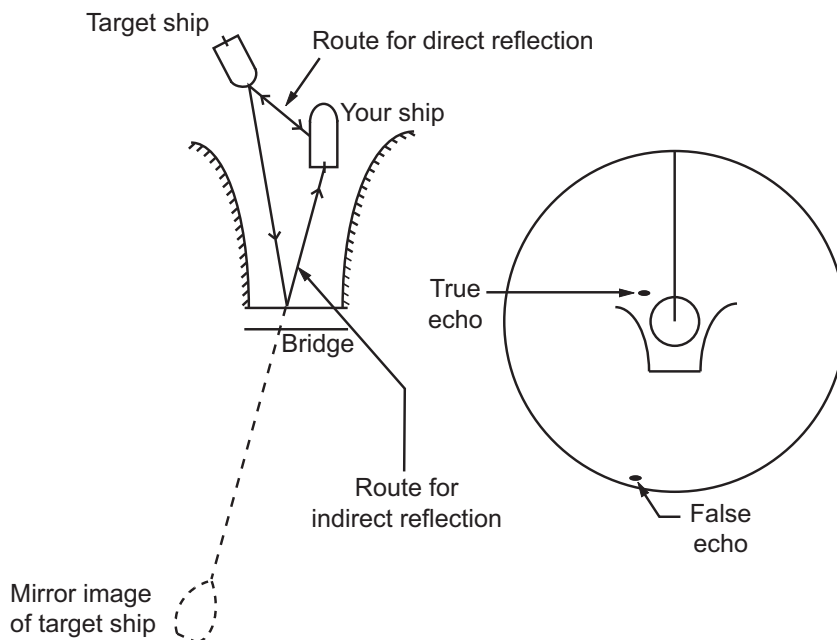

Shadow sectors

Funnels, stacks, masts, or derricks in the path of the antenna block the radar beam. If the angle subtended at the antenna is more than a few degrees, a non-detecting sector may be produced. Within this sector targets can not be detected.

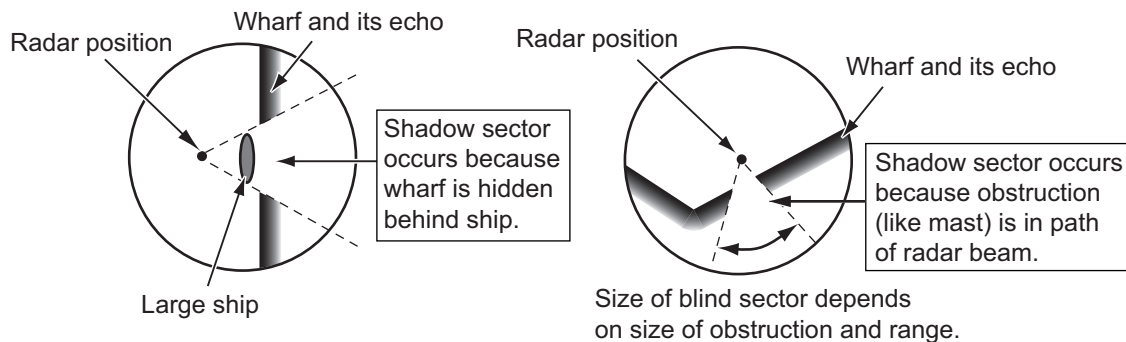

2.3 SART (Search and Rescue Transponder)

2.3.1 SART description

A Search and Rescue Transponder (SART) can be triggered by any X-Band (3 cm) radar within a range of approximately 8 nm. Each radar pulse received causes it to transmit a response which is swept repetitively across the complete radar frequency band. When interrogated, it first sweeps rapidly ($0.4 \mu\text{s}$) through the band before beginning a relatively slow sweep ($7.5 \mu\text{s}$) through the band back to the starting frequency. This process is repeated for a total of twelve complete cycles. At some point in each sweep, the SART frequency will match that of the interrogating radar and be within the pass band of the radar receiver. If the SART is within range, the frequency match during each of the 12 slow sweeps will produce a response on the radar display, thus a line of 12 dots equally spaced by about 0.64 nautical miles will be shown.

When the radar to the SART is reduced to about 1 nm, the radar display may show also the 12 responses generated during the fast sweeps. These additional dot responses, which also are equally spaced by 0.64 nautical miles, will be interspersed with the original line of 12 dots. They will appear slightly weaker and smaller than the original dots.

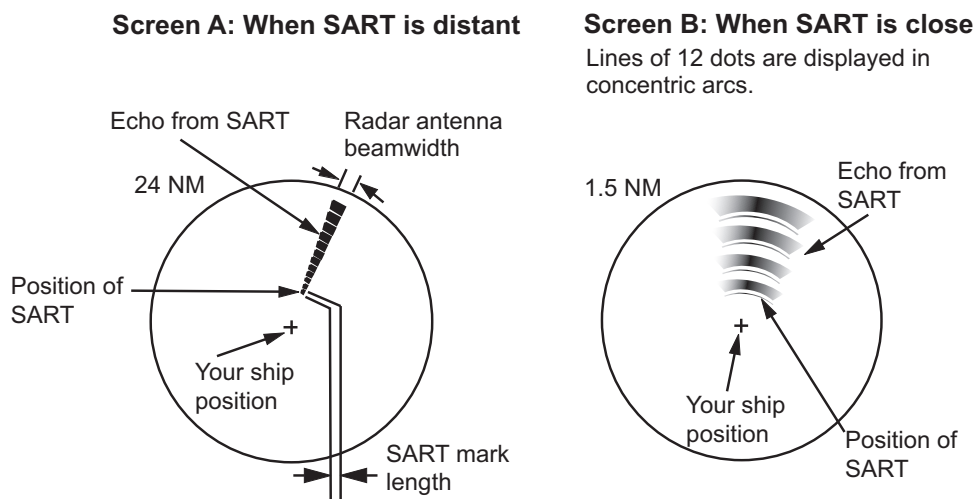

2.3.2 How to show SART marks on the radar display

This radar is equipped with a feature that optimally sets up the radar for SART detection. This feature automatically detunes the radar receiver out of its best tuning condition. This erases or weakens all normal radar echoes, but the SART marks are not erased because the SART response signal scans over all frequencies in the 9 GHz band. When the radar approaches the SART in operation, the SART marks will enlarge to large arcs, blurring a large part of the screen.

Note: The following procedure is not available from FAR-2x58 monitors which are assigned as [SUB] at installation.

1. Open the menu.
2. Select [1 ECHO], then press the **ENTER MARK** key.
3. Select [7 SART], then press the **ENTER MARK** key.
4. Select [ON] to show SART marks on the radar display, then press the **ENTER MARK** key. Select [OFF] to hide SART marks.

When the SART function is active, the settings listed in the table on the following page are automatically made to radar functions:

Setting	Changed to
Range	12 NM
Pulselength	Long
Echo Stretch	Off
Noise Rejector	Off
Echo Averaging	Off
Interference Rejector	Off
Performance Monitor	Off
A/C RAIN	Off

5. Close the menu.

The indication "SART" appears at the top of the screen, in yellow text, when this feature is active. Be sure to turn this feature off when SART detection is no longer your objective.

2.3.3 General remarks on receiving SARTs

SART range errors

When responses from only the 12 low frequency sweeps are visible (when the SART is at a range greater than about 1 nm), the position at which the first dot is displayed can be as much as 0.64 nm beyond the true position of the SART. When the range closes so that the fast sweep responses are seen also, the first of these will be no more than 150 meters beyond the true position.

Radar bandwidth

This is normally matched to the radar pulselength and is usually switched with the range scale and the associated pulselength. Narrow bandwidths of 3-5 MHz are used with long pulses on long range scales and wide bandwidths of 10-25 MHz with short pulses on short ranges.

A radar bandwidth of less than 5 MHz will attenuate the SART signal slightly, so it is preferable to use a medium bandwidth to ensure optimum detection of the SART.

Radar sidelobes

As the SART is approached, sidelobes from the radar antenna can show the SART responses as a series of arcs or concentric rings. These can be removed by the use of the anti-clutter sea control although it can be operationally useful to observe the side lobes as they may be easier to detect in clutter conditions and also they will confirm that the SART is near to own ship.

Note: SART information excerpted from IMO SN/Circ 197 OPERATION OF MARINE RADAR FOR SART DETECTION.

2.4 RACON

A RACON is a radar beacon that emits radar receivable signals in the radar frequency spectrum (X- or S-band). There are several signal formats; in general, the RACON signal appears on the radar screen as a rectangular echo originating at a point just beyond the position of the radar beacon. It has a Morse coded pattern. Note that the position on the radar display is not accurate.



Echoes on the radar screen

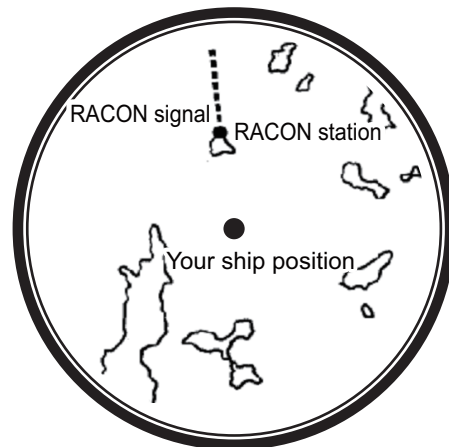

Echo description

2.5 Radar Target Enhancer (RTE)

An RTE is a radar transponder mounted on navigation buoys and masts of small crafts to significantly improve their detection by radar. Unlike a SART or RACON, which are passive, the RTE receives a radar signal, amplifies it and re-transmits it, with the intention of making the target's signal look larger on a radar display. The RTE is available in X-band and S-band types.

2.6 Solid state radar

In Solid State radars, long-range and short-range pictures are mixed before they are displayed on the screen. Due to this mixing process, echoes may be displayed differently when compared with magnetron radars.

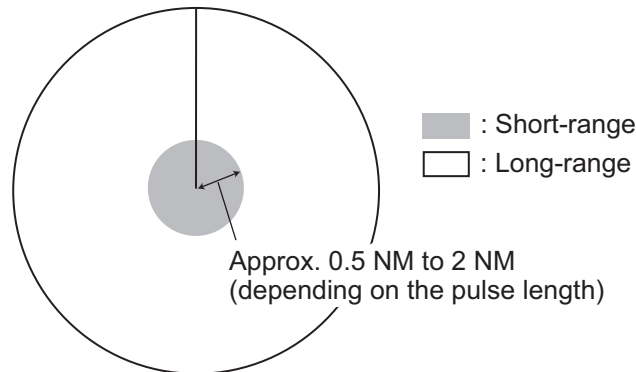

Range and signal intensity

At long-range, even though the Solid State radar has lower transmission power than magnetron radars, the signal intensity is equivalent.

At short-range on the other hand, due to the lower transmission power the signal intensity of closer targets (including sea clutter and rain clutter) is reduced.

For this reason, when a long-range target enters short-range the signal intensity appears weaker.

False echoes fore and aft of the target

At long-range, echoes with a strong reflection may appear with a false echo to their fore and aft. When the target changes direction, the reflection may weaken, causing the false echoes to disappear. You can also reduce the false echoes in these cases by reducing the gain.

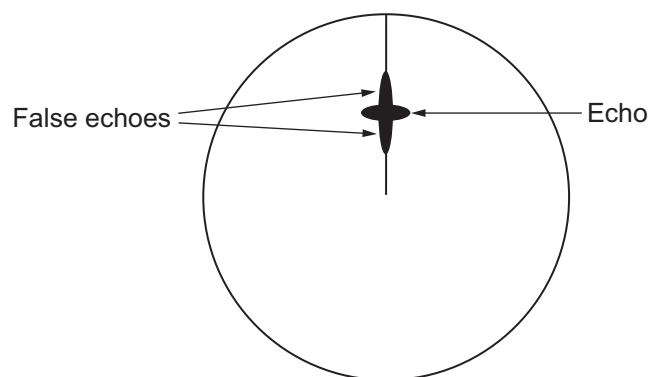

3. TARGET TRACKING (TT)

3.1 Precautions when Using Target Tracking

WARNING

No one navigational aid should be relied upon for the safety of vessel and crew. The navigator has the responsibility to check all aids available to confirm position. Electronic aids are not a substitute for basic navigational principles and common sense.

- ◆ This TT automatically tracks automatically or manually acquired radar targets and calculates their courses and speeds, indicating them by vectors. Since the data generated by the auto plotter are based on what radar targets are selected, the radar must always be optimally tuned for use with the auto plotter, to ensure required targets will not be lost or unwanted targets such as sea returns and noise will not be acquired and tracked.
- ◆ A target does not always mean a land-mass, reef, ships or other surface vessels but can imply returns from sea surface and clutter. As the level of clutter changes with environment, the operator should properly adjust the [A/C SEA], [A/C RAIN] and [GAIN] controls to be sure target echoes are not eliminated from the radar screen.

CAUTION

The plotting accuracy and response of this TT meets IMO standards. Tracking accuracy is affected by the following:

- ◆ Tracking accuracy is affected by course change. One to two minutes is required to restore vectors to full accuracy after an abrupt course change. (The actual amount depends on gyrocompass specifications.)
- ◆ The amount of tracking delay is inversely proportional to the relative speed of the target. Delay is on the order of 15 - 30 seconds for high relative speed; 30 - 60 seconds for low relative speed.
- ◆ The target tracking and pertinent vector calculation accuracy is influenced by the following:
 - Echo intensity
 - The range measurement accuracy; characterized by both random and biased measurement errors.
 - The angular measurement accuracy; characterized by beam shape, target glint and bias errors.
 - Radar transmission pulsewidth
 - Gyrocompass heading error
 - Speed log error
 - Current and wind (set & drift)
 - Course change (own ship and target)

The data generated by TT, AIS and video plotter are intended for reference only.

Refer to official nautical charts for detailed and up-to-date information.

3. TARGET TRACKING (TT)

3.2 TT Controls

The control unit has three keys that are used in the target tracking mode. The keys are indicated in the figure below.

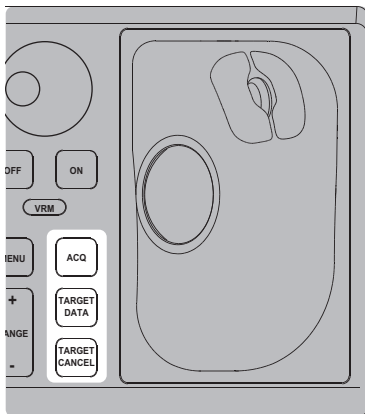

RCU-014

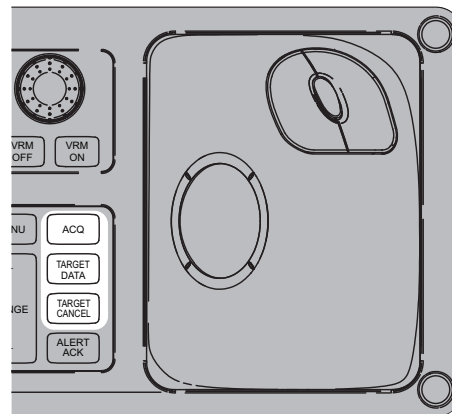

RCU-031

- **ACQ**: Acquires the selected echo as a target.
- **TARGET DATA**: Shows the selected target's data in the information box.
- **TARGET CANCEL**: Deactivates tracking for the cursor-selected target.

These functions, along with other TT functions, can also be accessed from the [CURSOR] menu (See section 1.7.3).

3.3 How to Show/Hide the TT Symbols

You can show/hide the TT symbols to suit your requirements. To hide the symbols, left-click the TT indication in the TT•AIS box to show [OFF]. To show the symbols, left-click the indication to show [AUTO]*, [AUTO/MAN]*, [MAN]*.

*: These TT modes and their settings are described in section 3.4.

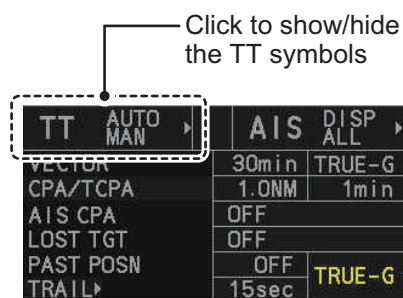

Note: The TT mode indication is hidden when [SIMPLE] display mode is used. To change TT settings in [SIMPLE] mode, first restore [NORMAL] display mode, adjust the settings, then return to [SIMPLE] mode. See section 1.9 for how to change the display mode.

3.4 How to Select the TT mode

This radar can automatically acquire and track a maximum of 100 targets.

The number of automatically and manually acquired targets is determined by the setting for [TT SELECT] in the [TT] menu.

A target just acquired automatically is marked with a dashed circle and a vector appears within one minute to indicate the target's motion trend. If the target is consistently detected for three minutes, the plotting symbol changes to a solid circle. If acquisition fails, the target symbol blinks.

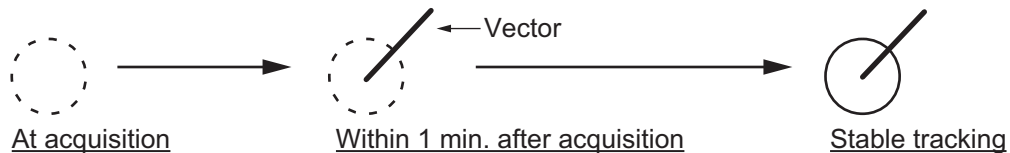

3.4.1 How to setup the acquisition method

You can set the system to acquire targets automatically, manually, or a combination of automatic and manual.

1. Open the menu.
2. Select [5 TT•AIS].



3. **For IMO-types**, select [6 TT].
For C-types, select [5 TT].

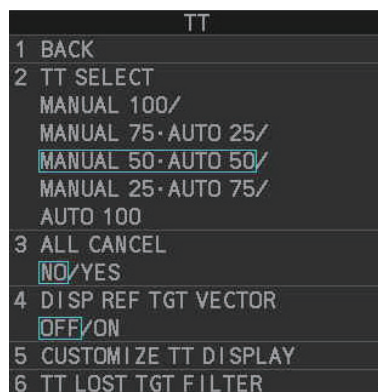

Note: You can also right-click the TT indication in the [TT•AIS] box to open the [TT] menu.

4. Select [2 TT SELECT], then select the acquisition condition.

Menu setting	Acquisition condition
[MANUAL 100]	100 targets manually, auto acquisition not available
[MANUAL 75 • AUTO 25]	25 targets automatically, 75 targets manually
[MANUAL 50 • AUTO 50]	50 targets automatically, 50 targets manually
[MANUAL 25 • AUTO 75]	75 targets automatically, 25 targets manually
[AUTO 100]	100 targets automatically, manual acquisition not available

3. TARGET TRACKING (TT)

5. Close the menu.

The selected settings change how the TT indication is displayed in the TT•AIS box as follows:

TT mode selected	Indication change
[MANUAL 100]	"TT OFF" → "TT MAN" → "TT OFF"...
[MANUAL 75 • AUTO 25]	"TT OFF" → "TT MAN/AUTO" → "TT OFF"...
[MANUAL 50 • AUTO 50]	"TT OFF" → "TT MAN/AUTO" → "TT OFF"...
[MANUAL 25 • AUTO 75]	"TT OFF" → "TT MAN/AUTO" → "TT OFF"...
[AUTO 100]	"TT OFF" → "TT AUTO" → "TT OFF"...

Note: When the menu-set number of automatically acquired targets have been acquired, the Alert "TT TARGET FULL(AUTO)" appears in the [Alert] box.

3.4.2 How to manually acquire targets

Note: The following procedure requires [2 TGT DATA/ACQ SETTING] on the second page of the [CURSOR] menu to be set as [ANY] or [TT ONLY].

Acquire a target from the Control Unit (RCU-014/RCU-031)

Use the trackball to place the cursor on the target you want to acquire, then press the **ACQ** key.

Acquire a target by the trackball module

1. When the target to acquire and the AIS symbol overlap one another, right-click the operational display area to show the [CURSOR MENU].
2. Select [TT TARGET DATA/ACQ].
3. Place the cursor on the target to acquire then left-click.

Note 1: For successful acquisition, the target should be within 24 NM (or 32 NM, depending on initial setting) from own ship and not obscured by sea or rain clutter.

Note 2: You are alerted when the capacity of manual acquisition is 95% and 100%. These alerts are "TT TARGET95%(MAN)" and "TT TARGET FULL(MAN)". If the capacity is 100% you cannot acquire more targets. Cancel tracking of non-threatening targets if you wish to acquire additional targets manually.

Note 3: When a target being tracked nears another target being tracked, the targets may be "swapped". When two targets acquired either automatically or manually come close to each other, one of the two may become a lost target. If this occurs, manual re-acquisition of the lost target may be necessary after the two have separated.

Note 4: You can reuse a target number. This is useful when you acquire the "wrong" target. Drag and drop the symbol onto the correct target.

3.4.3 How to automatically acquire targets

Targets are automatically acquired when the TT mode is set to other than [MANUAL 100] and a target enters the acquisition zone (see section 3.14). The maximum tracking distance (24 NM, 32 NM or 48 NM*) is set at installation.

*: The maximum track distance of 48 NM is only available for the FAR-2x58.

3.5 How to Enter Own Ship Speed

The TT requires own ship's speed and heading data. The speed can be STW, SOG or echo-referenced speed (based on 3 max. stationary objects). Manual input is also possible. For automatic or manual input, see section 1.11. For echo-referenced speed input follow the procedure below.

3.5.1 Echo-referenced speed input

The use of echo-referenced speed is recommended when:

- The speed log is not operating properly or not connected to the radar.
- The vessel has no device (doppler sonar, speed log, etc.) that can measure ship's bow-stern, port-starboard movement.

If you select echo-referenced speed, the TT calculates own ship's speed relative to a fixed reference target. The number of targets may be R1, R2 or R3. When a plural of objects are selected, the mean value is used, for stabilization and speed.

1. Right-click the operational display area to show the [CURSOR MENU].
2. Select [REF MARK]. The cursor is highlighted to indicate that the reference mark function is active.
3. Place the cursor on a fixed echo (such as an island, etc.) at a range of 0.1 to 24 NM from own ship, to be used as a reference, then left-click. The cursor changes from the highlighted cross to a circle with dashed lines, indicating that the reference location is now set. See section 3.8 for more information on TT symbols and their attributes.

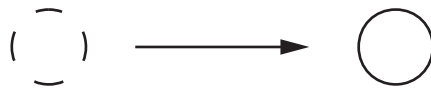

At acquisition

Stable tracking

The dashed lines of the reference point change to a solid line over time, as shown in the figure above.

4. Repeat step 3 until to place up to three reference points.
5. Right-click to deactivate the reference mark function.
6. Open the menu.
7. Select [7 INFORMATION BOX].
8. Select [2 OWN SHIP INFO].
9. Select [2 SHIP SPEED].
10. Select [REF].
11. Close the menu.

It takes approximately one minute for the speed to appear in the own ship information box. When the speed appears, the indication "REF BT" also appears to the right of the speed value.

SPEED	
1	BACK
2	SHIP SPEED LOG(BT)/LOG(WT)/ EPFS/MANUAL/REF/ ECDIS
3	MANUAL SPEED INPUT 0.0kn
4	SET DRIFT OFF/ON 000.0° 00.0kn

3. TARGET TRACKING (TT)

Notes on speed input by reference target

- Reference targets are only used for the calculation of true speed.
- Do not use reference target generated true speed to calculate relative speed. Relative speed data is not accurate because response to speed change is slow, hampering the TT's ability to accurately judge the possibility of collision.
- Select a stationary target as a reference target to calculate own ship speed as ground tracking speed. Do not choose a moving target as a reference target. A moving target produces error in the vector for TT and AIS, which results in wrong collision avoidance information. Further, an unstable stationary target produces inaccurate speed data and the target itself may become lost.
- On IMO-type radars with AIS in use, echo-referenced speed is shown in gray to indicate they are not available for selection.
- When a reference target is lost or goes out of the acquisition range, that reference target mark blinks and the indication "REF TARGET LOST" appears in the alert box. If all reference targets are lost, the speed indication reads "*.*" Select a different reference target if currently selected one is lost.
- When all targets are deleted, the reference target mark is also deleted and the target-based speed becomes invalid. The speed is indicated as "BTREF" where BT means Bottom Track (speed over ground).
- For IMO-types only, reference targets can be marked with a vector. This can be done with [REF TARGET VECTOR] on the [TT TARGET] menu.
- Loss of reference target will affect the calculation of true speed and true course of targets. Further, own ship speed will be inaccurate.

How to cancel echo-referenced speed input

1. Open the menu.
2. Select [7 INFORMATION BOX].
3. Select [2 OWN SHIP INFO].
4. Select [3 SPEED]. The [SPEED] menu appears.
5. Select any option, other than [REF].
6. Close the menu.

3.6 How to Cancel Target Tracking

When the number of tracked targets reaches maximum capacity, the alert box shows [TT TARGET FULL (MAN)] or [TT TARGET FULL (AUTO)], based on the selected TT mode. No new targets can be acquired until a tracked target is lost or tracking is canceled. When this occurs, cancel tracking for non-dangerous targets as required.

3.6.1 How to cancel tracking for individual TT targets

Note: The following procedure requires [3 TGT CANCEL SETTING] on the second page of the [CURSOR] menu to be set as [ANY] or [TT ONLY].

Using the control unit (RCU-014/RCU-031)

1. Place the cursor on the tracked target, or tracked target's data, to cancel.
2. Press the **TARGET CANCEL** key.

Using the CURSOR menu

1. Right-click the operational display area to show the [CURSOR MENU].
2. Select [TARGET CANCEL], then left-click.
3. Select the tracked target to cancel, then left-click.
4. Right-click to complete the procedure.

3.6.2 How to cancel tracking for all TT targets

Using the control unit (RCU-014/RCU-031)

Press and hold the **TARGET CANCEL** key.

Using the menu

1. Open the menu.
2. Select [5 TT•AIS].
3. **For IMO-types**, select [6 TT].
For C-types, select [5 TT].
4. Select [3 ALL CANCEL].
5. Select [YES] to cancel tracking for all TT targets.
6. Close the menu.

3.7 Lost Target

Targets not detected in nine consecutive scans become “lost targets”. A lost target is shown in the display with a flashing red “x”. Flashing stops after lost target alert is acknowledged. Further, the alert box shows the indication “TT TARGET LOST” in orange characters and the audible alert sounds. The symbol disappears when the alert is acknowledged.

If you are in an area where tracked targets are lost frequently, you may want to disable the lost target alert against tracked targets by maximum range.

3.7.1 How to set the lost target filter

You can set the lost target alert to sound against lost targets that are within a specific range. To set the criteria, use the procedure below.

1. Open the menu.
2. Select [5 TT•AIS].
3. **For IMO-types**, select [6 TT].
For C-types, select [5 TT].
4. Select [7 TT LOST TGT FILTER].
5. Select [MAX RANGE].
6. Select [ON]. The settings can now be adjusted.
7. Spin the scrollwheel to adjust the setting as required, then left-click to apply the setting.
8. Close the menu.



Note: Reference targets are not affected by this filter.

3.7.2 How to enable/disable the lost target alert

The [LOST TARGET] box, located at the bottom-right corner of the screen, enables and disables the lost target alert. This setting is shared for TT and AIS functions.

Select the box with the cursor, then left-click to cycle through the settings in the following order: [OFF] → [FILT] → [ALL] → [OFF]...

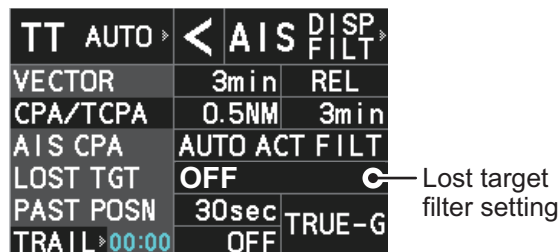

- [OFF]: Disable the alert.
- [FILT]: Enable the alert for all lost targets, excluding filtered targets.
- [ALL]: Enable the alert for all lost targets, including filtered targets.

Note: The lost target filter setting is hidden when [SIMPLE] display mode is used. To change TT settings in [SIMPLE] mode, first restore [NORMAL] display mode, adjust the settings, then return to [SIMPLE] mode. See section 1.9 for how to change the display mode.

3.8 TT Symbols and Attributes

The TT symbols used in this equipment are compliant with IEC62288. For details regarding the symbols and their meanings, see "TT/AIS symbols" on page AP-34.

3.8.1 How to adjust symbol brilliance

Note: Each color scheme (palettes PLT1 to PL4) can be adjusted individually. For how to select a color scheme, see section 1.46.3.

1. Open the menu.
2. Select [9 INITIAL SETTINGS].
3. Select [2 BRILL]. The [BRILL] menu appears.
4. Select [0 NEXT] to show the next menu page.
5. Select [7 TT SYMBOLS]. The settings are highlighted and can now be adjusted.
6. Spin the scrollwheel to select the desired brilliance, then left-click to apply the setting.
7. Close the menu.

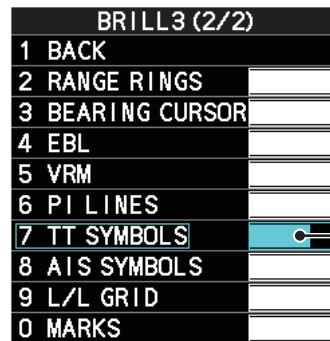

Spin the scrollwheel to adjust the brilliance.

3.8.2 How to set the symbol color

1. Open the menu.
2. Select [5 TT•AIS].
3. **For IMO-types**, select [4 TT•AIS SYMBOL].
For C-types, select [3 TT•AIS SYMBOL].

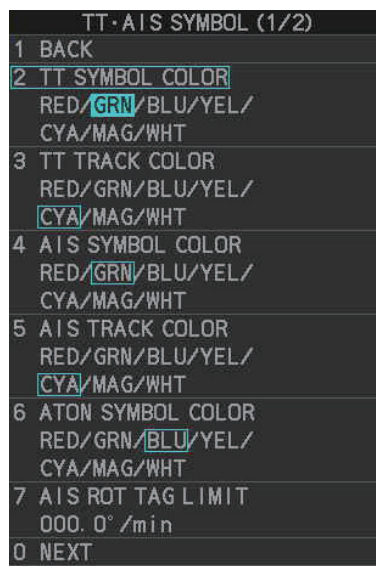

4. **For IMO-types**, select [2 TT•AIS SYMBOL COLOR].
For C-types, select [2 TT SYMBOL].

Note: For IMO-types, symbol color is shared between TT and AIS.

5. Select the appropriate color, then left-click.
6. Close the menu.

3. TARGET TRACKING (TT)

3.8.3 How to set the symbol size (C-types only)

C-types radar can show TT symbols in small or large size. You can change the size with the following procedure.

1. Open the menu.
2. Select [5 TT•AIS].
3. Select [3 TT•AIS SYMBOL].
4. Select [0 NEXT] to show the second page of the menu.
5. Select [4 TT SYMBOL SIZE].
6. Select [SMALL] or [LARGE] as required.
7. Close the menu

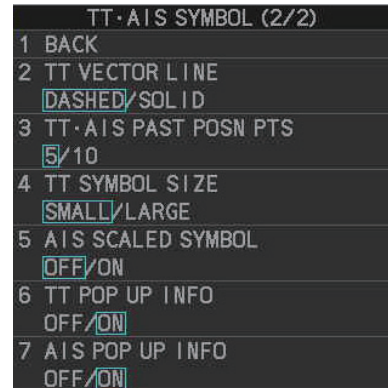

3.8.4 How to select a TT symbol (C-type only)

With a C-type radar, you can assign a symbol (other than the standard circle) to TT targets. You can also change the color and naming for the TT symbols. There are 10 preset symbols available. The following figure shows the default presets, in numerical order.

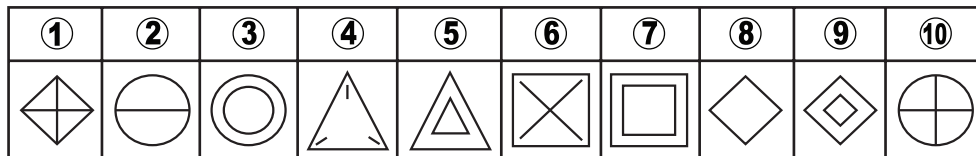

How to select a symbol from the presets

Place the cursor on the TT symbol you want to change, then spin the scrollwheel. The selected target's symbol changes in numerical order. To change the attributes of each preset, see section 3.8.5.

How to change the attributes assigned to a symbol

- Place the cursor on the symbol whose attributes you want to change, then right-click.
The editing window appears (either [TT CUSTOM SELECT], or [INPUT TT LABEL]). Press **F3** to toggle between the windows.



Press **F3** to toggle between the two windows.

Note: You can also left-click the TT target's data in the information box (see section 3.9.2) to show the editing window.

- If the [INPUT TT LABEL] window is shown, press **F3** to show the [TT CUSTOM SELECT] window.
- Referring to the following table, select the item you want to edit.

Menu item	Description
[LABEL]	Assigns a number to the target, other than the pre-assigned TT number. Note 1: The value set here appears in front of the name (assigned at [TGT NAME]). If no name is set, only the label appears with the target. Note 2: If "00" is set as the value, the label does not appear on-screen.
[PRESET NUMBER]	Assign preset attributes to the symbol. Note: You can change the symbol color, symbol shape and track color assigned to the preset.
[SMBL COLOR]	Assign a color to the TT symbol.
[SMBL SHAPE]	Assign a shape to the TT symbol.
[TRACK COLOR]	Assign a color to the track for the selected target.
[TGT NAME]	Assign a name to the target. Note: The software keyboard appears inside the editing window. See section 1.5.3 for how to use the keyboard.

- Select [RUN] to apply the changes and close the editing window.

3.8.5 How to change the attributes for a TT symbol preset

The attributes for each preset can be customized to suit your preferences.

- Open the menu.
- Select [5 TT•AIS].
- Select [5 TT].

3. TARGET TRACKING (TT)

4. Select [5 CUSTOMIZE TT DISPLAY]. The [TT CUSTOM SETTINGS] window appears.

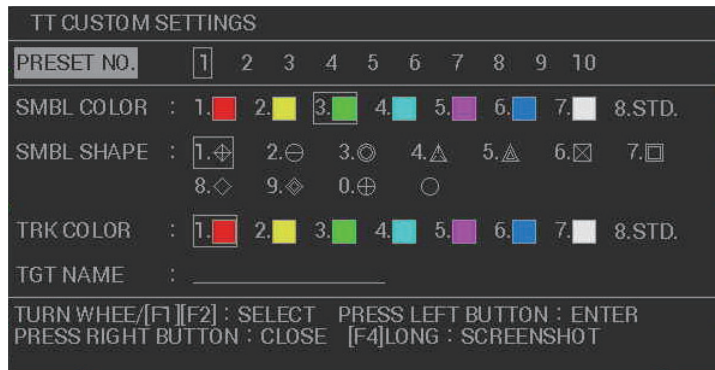

5. Select [PRESET NO.].
6. Select the preset number whose attribute you want to change. The settings indicated at [SMBL COLOR], [SMBL SHAPE], [TRK COLOR] and [TGT NAME] change according to the preset selected.
7. Referring to the following table, select the item you want to edit.

Menu item	Description
[SMBL COLOR]	Change the symbol color for the selected preset.
[SMBL SHAPE]	Change the symbol shape for the selected preset.
[TRACK COLOR]	Change the track color for the selected preset.
[TGT NAME]	Assign/change the target name. Note: The software keyboard appears inside the editing window. See section 1.5.3 for how to use the keyboard.

8. Right-click to close the window.

3.9 How to Display/Remove Target Data

The TT mode provides the full functionality of TT as required by the IMO Resolution A.823(19) and IEC 62288, including display of range, bearing, course, speed, CPA and TCPA of all tracked targets.

The target bearing is shown in relative bearing in the HEAD UP mode and true bearing in the COURSE UP, NORTH UP and True Motion modes, with the suffix "R" (Relative) or "T" (True).

The target speed and course are shown as speed over the ground or speed through the water depending on speed source.

3.9.1 TT pop up information

The TT pop-up shows abbreviated TT data for the selected TT. Simply put the cursor on the TT symbol to show the pop-up. The following figure shows pop-up examples.

	<u>C-type</u>	<u>IMO-type</u>																																	
	<table border="1"> <thead> <tr> <th>TT No.</th> <th>Label*</th> <th>Name*</th> </tr> </thead> <tbody> <tr> <td>TT 001</td> <td>10</td> <td>FURUNO</td> </tr> <tr> <td>CRS</td> <td>183.9°T</td> <td></td> </tr> <tr> <td>SPD</td> <td>10.2kn</td> <td></td> </tr> <tr> <td>CPA</td> <td>0.860NM</td> <td></td> </tr> <tr> <td>TCPA</td> <td>-29:09</td> <td></td> </tr> <tr> <td colspan="3">TRACK OFF</td> </tr> </tbody> </table>	TT No.	Label*	Name*	TT 001	10	FURUNO	CRS	183.9°T		SPD	10.2kn		CPA	0.860NM		TCPA	-29:09		TRACK OFF			<table border="1"> <thead> <tr> <th>TT No.</th> <th></th> </tr> </thead> <tbody> <tr> <td>TT 002</td> <td></td> </tr> <tr> <td>COG</td> <td>359.6°T</td> </tr> <tr> <td>SOG</td> <td>0.1kn</td> </tr> <tr> <td>CPA</td> <td>0.606NM</td> </tr> <tr> <td>TCPA</td> <td>-08:26</td> </tr> </tbody> </table>	TT No.		TT 002		COG	359.6°T	SOG	0.1kn	CPA	0.606NM	TCPA	-08:26
TT No.	Label*	Name*																																	
TT 001	10	FURUNO																																	
CRS	183.9°T																																		
SPD	10.2kn																																		
CPA	0.860NM																																		
TCPA	-29:09																																		
TRACK OFF																																			
TT No.																																			
TT 002																																			
COG	359.6°T																																		
SOG	0.1kn																																		
CPA	0.606NM																																		
TCPA	-08:26																																		
<p>For C-types, course and speed appear as "CRS" and "SPD" respectively.</p> <p>*: Label and Name appear only when assigned.</p>	<p>Current track setting</p>																																		

The popup can be enabled or disabled with the following procedure.

1. Open the menu.
2. Select [5 TT•AIS].
3. **For IMO-types**, select [4 TT•AIS SYMBOL], then select [0 NEXT].
For C-types, select [3 TT•AIS SYMBOL], then select [0 NEXT].
4. Select [6 TT POP-UP INFO].
5. Select [ON] or [OFF] as required.
6. Close the menu

3. TARGET TRACKING (TT)

3.9.2 How to show target data in the data display area

Place the cursor on a desired tracked target and left-click, or press the **ACQ** key. The target's symbol is surround with a broken square and the selected TT target's data is shown in the data display area.

Note: This feature requires [2 TGT DATA/ACQ SETTING] on the second page of the [CURSOR] menu to be set as [ANY] or [TT ONLY].

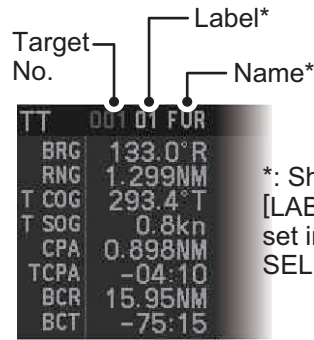

*: Shown for C-types only when [LABEL] and [TGT NAME] are set in the [TT CUSTOM SELECT] settings window.

Indication	Description
Target No.	Number assigned by the system to this target. Target numbers which have become vacant are not re-used until the system is restarted, or the system tracks more than 100 targets.
Label	Label number assigned to this target (C-types only).
Name	Name assigned to this target (C-types only).
BRG	Bearing from own ship to target in relative (R) or True (T) reference.
RNG	Range from own ship to target.
T COG	Relative (R) or True (T) Course Over Ground of target. Displayed as "T CTW" where speed input is set to [LOG(WT)]. Displayed as "R CRS" where speed data is not available.
T SOG	Relative (R) or True (T) Speed Over Ground of target. Displayed as T STW where speed input is set to [LOG(WT)]. Displayed as R SPD where speed data is not available.
CPA*	Closest Point of Approach of target to own ship.
TCPA*	Time to CPA of target to own ship.
BCR*	Bow crossing range of target.
BCT*	Bow crossing time of target.

*: Not shown for C-types when the following menu settings (see section 1.48) are applied:

- Main menu → [7 INFORMATION BOX] → [7 TARGET DATA] is set to [5 BOX].
- Main menu → [7 INFORMATION BOX] → [8 DISPLAY TT COORDS] is set to [ON].
When [8 DISPLAY TT COORDS] is set to [ON], these items are replaced with the latitude/longitude of the target, as shown in the following example.

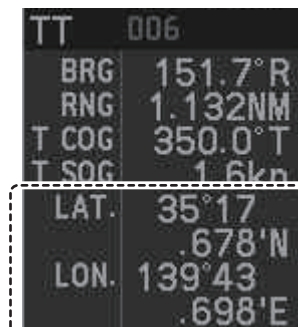

CPA, TCPA, BCR and BCT are replaced with the lat/lon coordinates for the target.

The number of TT data that can be displayed at one time in the information box depends on your settings for [7 INFORMATION BOX] (see section 1.48).

To remove the target data, place the cursor on a desired tracked target and press the **TARGET CANCEL** key, left-click. The select target's data is removed from the data display area.

3.9.3 How to display, hide and sort the target list

The target list provides a comprehensive data display of all TT (and AIS) targets being tracked (up to 1303 targets on total).

How to display/hide the target list

Select the [TGT LIST] menu item at the bottom-right of the screen, then left-click. The target list appears inside the information box.

TARGET LIST (1/72)			
SORT		RANGE	
FILTER ALL TGT			
1 BACK(L=TOP)			
2	TT	004	
	BRG	084.1°R	RNG 1.139NM
	CPA	1.138NM	TCPA 00:14
3	AIS	missing	
	BRG	112.8°R	RNG 1.677NM
	CPA	1.534NM	TCPA -01:49
4	AIS	missing	
	BRG	096.1°R	RNG 1.932NM
	CPA	1.462NM	TCPA -64:32
5	AIS	missing	
	BRG	109.9°R	RNG 2.058NM
	CPA	2.052NM	TCPA -06:47
6	TT	001	
	BRG	135.6°R	RNG 2.068NM
	CPA	1.359NM	TCPA -07:14
7	TT	005	
	BRG	045.6°R	RNG 2.079NM
	CPA	1.836NM	TCPA 06:24
9 REFRESH DATA			
0 NEXT(L=LAST)			

Target details

The following operations are available when the list is open:

- Go to next page: Click [0 NEXT].
- Go back one page: Click [1 BACK].
- Go to the top (first) page of the list: Select [1 BACK], then press and hold the **left-button**.
- Go to the last (bottom) page of the list: Select [0 NEXT], then press and hold the **left-button**.
- Refresh the list: Click [9 REFRESH DATA].

To hide the list, do one of the following:

- Place the cursor inside the list, then right-click.
- Press the **MENU** key.
- Left-click the [MENU] box.

3. TARGET TRACKING (TT)

How to sort the target list

1. With the target list displayed, place the cursor on the sorting method indication to the right of [SORT] ("CPA" in the example below). The indication is highlighted.
2. Spin the scrollwheel to select the sort method, referring to the table below, then left-click.

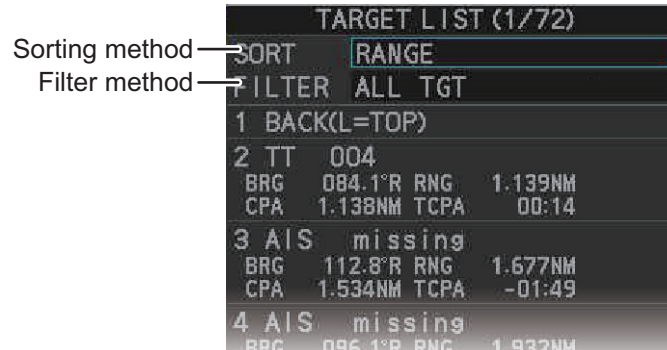

Sorting method	Description
[CPA]	Targets are sorted in order from closest to farthest CPA.
[TCPA]	Targets are sorted in order from shortest to longest TCPA.
[BCR]	Targets are sorted in order from closest to farthest BCR.
[BCT]	Targets are sorted in order from shortest to longest BCT.
[RANGE]	Targets are sorted in order from closest to farthest range.
[SPEED]	Targets are sorted in order from fastest to slowest.
[NAME]	Targets are sorted in Alphabetical order.

Note: Targets with no data are sorted to the back of the list, regardless of the selected sorting method.

3. Set the filter method in the same manner.

Filter method	Description
[TT ONLY]	Show only TT targets.
[AIS ONLY]	Show only AIS targets.
[DISP FILTER]	Show only filtered targets.
[ALL TGT]	Show all targets (ignore filter settings).

4. Close the menu.

3.10 Vector Modes

Target vectors can be displayed relative to own ship's heading (Relative) or North (True).

Note: IMO recommends the use of true vector mode in sea stabilization or relative vector mode for collision avoidance.

3.10.1 Description of vectors

Stabilization modes

It is important to select the optimum stabilization mode for the radar display. To assess risk of collision the relative motion of a target gives the clearest indication of CPA and may be monitored by observing either the direction of the target's relative trail, or the CPA predicted by the relative vector. By default, relative motion displays relative target trails and true motion displays true target trails. Where true target trails is selected, a sea stabilized display will indicate all targets' motion through the water. A ground stabilized display will indicate all targets' motion over the ground.

In coastal, estuarine and river waters where a significant set and drift may be experienced, a sea stabilized display will produce significant target trails from all fixed (stationary) objects possibly producing an unacceptably high level of clutter and masking. In such circumstances a ground stabilized display may reduce its effect and enable the observer to detect clearly the trails of moving targets, thus enhancing the observer's situational awareness.

However, the display should be considered only as an approximation of the course and speed made good over the ground. Among other factors, the accuracy of the ground-stabilization is affected by inaccuracies in speed and heading inputs as well as radar measurement imprecision and will require the display to be readjusted periodically. The information displayed should be interpreted with due regard to these factors.

Note: It should be noted that in determining a target's aspect by radar; the calculation of its true track is dependent on the choice and accuracy of the own ship's course and speed input. A ground-stabilized target plot may accurately calculate the ground track of the target, but the target's heading may be significantly different from its track when experiencing set, drift or leeway. Similarly, a sea stabilized target plot may be inaccurate when own ship and the target, are experiencing different rates of set, drift or leeway.

3. TARGET TRACKING (TT)

Ground stabilization and sea stabilization

Target vectors can be ground stabilized or sea stabilized in the True Motion mode. To select speed over the ground or speed through the water data, open the page from the menu. Select for ground stabilization or for sea stabilization. The vector mode indication shows the stabilization mode in the true motion as [TRUE-G] or [TRUE-S].

Sea stabilization is a mode where own ship and all targets are referenced to the sea using a compass heading and single-axis log water speed inputs in the true motion mode. Ground stabilization is a mode where own ship and all targets are referenced to the ground using the ground track or set and drift inputs. If the accuracy seems unsatisfactory, enter set and drift corrections. Note that set and drift should not be used when the radar is displaying AIS targets.

True vector

In the true motion mode, all fixed targets such as land, navigational marks and ships at anchor remain stationary on the radar screen with vector length zero. But in the presence of wind and/or current, the vectors appear on fixed targets representing the reciprocal of set and drift affecting own ship unless set and drift values are properly entered.

In the true vector mode, there are two types of stabilization: ground stabilization (TRUE-G) and sea stabilization (TRUE-S). The stabilization mode is automatically selected according to speed selection, as shown in the table below. Manual selection is available from the [SPD] menu at the top-right of the screen.

Speed selection	True vector mode
LOG(WT)	TRUE-S
LOG(WTC)	TRUE-G
LOG(BT)	TRUE-G
EPFS(BT)	TRUE-G
REF(BT)	TRUE-G
MAN(WT)	TRUE-S
MAN(WTC)	TRUE-G

Relative vector

Relative vectors on targets that are not moving over the ground such as land, navigational marks and ships at anchor will represent the reciprocal of own ship's ground track. A target whose vector passes through own ship is on a collision course. (Dotted lines in the figure are for explanation only.)

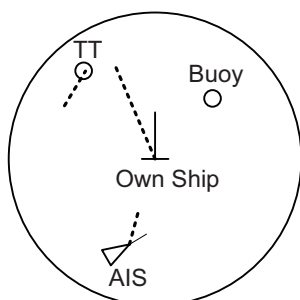

True vectors in ground stabilization

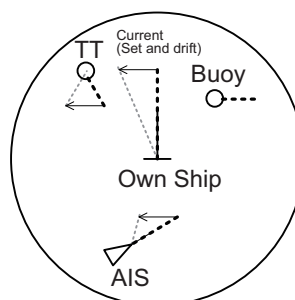

True vectors in sea stabilization

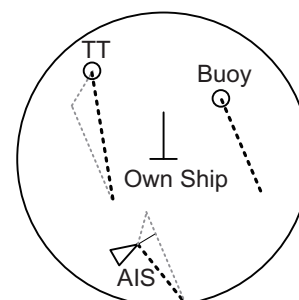

Relative vectors

3.10.2 Vector mode and vector length

Vectors can be displayed in true or relative modes. Vector lengths can be set between 30 seconds and 60 minutes.

The vector tip shows an estimated position of the target after the selected vector time elapses. It can be valuable to extend the vector length to evaluate the risk of collision with any target.

How to change the vector mode

Place the cursor on the vector reference indication in the [Vector] box, then left-click to cycle through the following settings.

[REL] → [TRUE-G/TRUE-S] → [REL]...

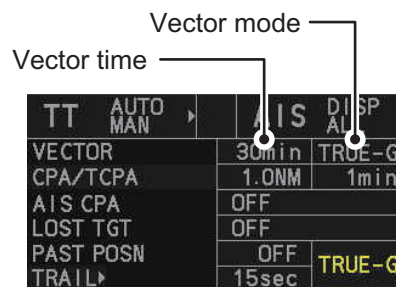

How to change the vector time

Place the cursor on the vector time indication in the [Vector] box, then left-click to cycle through the following settings.

[6min] → [10min] → [20min] → [30min] → [45min] → [60min] → [30sec] → [1min] → [3min] → [5min] → [6min]...

You can also spin the scrollwheel to change the vector time in one-minute increments.

Note: When [7 VECTOR TIME LINK] is set to [LINK RANGE], the trail time is also automatically adjusted as the range changes, to provide a “normalized” vector. While linked, the vector time indication appears in yellow color.

3.10.3 How to change the vector appearance (C-types only)

By default, vectors appear as a dashed line. For C-types, you can show vectors as a solid line with the following procedure.

1. Open the menu.
2. Select [5 TT•AIS].
3. Select [3 TT•AIS SYMBOL], then select [0 NEXT].
4. Select [2 TT VECTOR LINE].
5. Select [DASHED] or [SOLID] as required.
6. Close the menu

3.11 Past Position Display

The past position display shows equally time-spaced dots marking the past positions of any targets being tracked.

A new dot is added every minute (or at other preset time intervals) until the preset number is reached. If a target changes its speed, the spacing will be uneven. If it changes the course, its plotted course will not be a straight line.

Past position orientation, true or relative, is controlled with [TRAIL MODE] in the [TRAIL] context menu. To adjust the trail orientation, see section 1.37.1.

3.11.1 How to display past position points and select the plotting interval

Select the [PAST POSN] setting, then left-click to cycle through the following settings.

[OFF] → [30sec] → [1min] → [2min] → [3min] → [6min] → [OFF]...

When [OFF] is selected, all past position tracks are deleted.

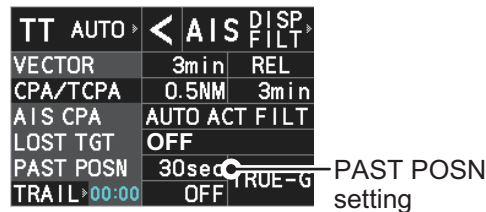

Note: The [PAST POSN] setting is hidden when [SIMPLE] display mode is used. To change the setting in [SIMPLE] mode, first restore [NORMAL] display mode, adjust the setting, then return to [SIMPLE] mode. See section 1.9 for how to change the display mode.

3.11.2 How to select the number of past position points to be displayed

1. Open the menu.
2. Select [5 TT•AIS].
3. **For IMO-types**, select [4 TT•AIS SYMBOL].
For C-types, select [3 TT•AIS SYMBOL], then select [0 NEXT].
4. **For IMO-types**, select [5 TT•AIS PAST POSN POINTS].
For C-types, select [3 TT•AIS PAST POSN POINTS].
5. Select [5] or [10] as appropriate.
6. Close the menu.

3.11.3 How to change the color of TT tracks (C-types only)

You can change the color of the TT tracks with the following procedure.

1. Open the menu.
2. Select [5 TT•AIS].
3. Select [3 TT•AIS SYMBOL].
4. Select [3 TT SYMBOL COLOR].
5. Select the desired color you want to show the TT tracks in.
6. Close the menu.

3.12 Set and Drift

Set, the direction in which a water current flows, can be manually entered in 0.1-degree steps. Drift, also known as “Rate”, or the speed of the current, can also be entered manually in 0.1-knot steps.

When course through water and speed through water are available, activate set and drift to get course over ground and speed over ground.

Set and drift corrections are beneficial for increasing the accuracy of vectors and target data. Refer to the tide table on board the ship for setting information. These values are applied to all targets. If stationary targets have vectors, set and drift values should be adjusted until they lose vectors.

To enter set and drift do the following:

1. Open the menu.
2. Select [7 INFORMATION BOX].
3. Select [2 OWN SHIP INFO].
4. Select [3 SPEED]. The [SPEED] menu appears.

Note: You can also access the [SPEED] menu from the on-screen box. Place the cursor on the [SPD ►] indication in the speed box at the top-right of the screen, then right-click.
5. Select [4 SET DRIFT].
6. Select [ON], then press the **ENTER MARK** key. The setting can now be adjusted and [SET] is selected.
7. Spin the scrollwheel to select the appropriate setting (Setting range: 000.0° to 359.9°), then left-click. The [DRIFT] setting is now selected.
8. Spin the scrollwheel to select the appropriate setting (Setting range: 00.0kn to 19.9kn), then left-click.
9. Close the menu.

Note 1: Set and drift are available when using manually input speed, speed through the water. The speed source is shown as "WTC" (Water Tracking Count).

Note 2: Set and drift should be checked periodically for correctness.

Note 3: When speed data input from the position sensor is valid, set and drift are not adjustable.

3.13 Collision Alarm (CPA, TCPA)

This radar calculates CPA and TCPA by using own ship and relative target positions.

The TT continuously monitors the predicted range at the Closest Point of Approach (CPA) and predicted time to CPA (TCPA) of each TT. When the predicted CPA of any TT becomes smaller than a preset CPA range and its predicted TCPA less than a preset TCPA limit, the audio alarm sounds and "TT DANGER OF COLLISION" appears (in red, flashing) in the Alert Box. In addition, the symbol of the offending TT is red and flashes together with its vector.

CAUTION

CPA/TCPA Alarm

The CPA and TCPA alarm feature should never be relied upon as the sole means for detecting the risk of collision. The navigator is not relieved of the responsibility to keep visual lookout for avoiding collisions, whether or not the radar or other plotting aid is in use.

This feature, when used correctly, helps prevent the risk of collision by alerting you to threatening targets. It is important that GAIN, A/C SEA, A/C RAIN and other radar controls are properly adjusted.

CPA and TCPA ranges must be set up properly taking into consideration the size, tonnage, speed, turning performance and other characteristics of own ship.

The reference point for CPA and TCPA calculation can be selected from antenna position or conning position. For further details, see section 1.51.

3.13.1 How to set the CPA and TCPA ranges

CPA and TCPA ranges can be adjusted from the appropriate indication in the [TT] box.

1. Left-click the [CPA/TCPA] indication to activate the feature.

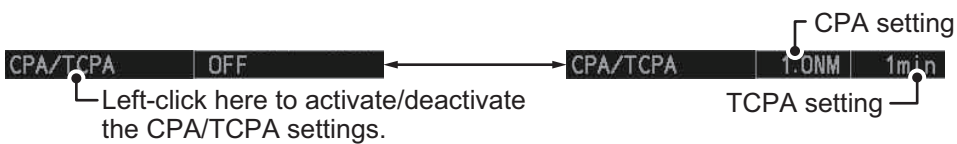

Note: The [CPA/TCPA] indication is hidden when [SIMPLE] display mode is used. To change the setting in [SIMPLE] mode, first restore [NORMAL] display mode, adjust the setting, then return to [SIMPLE] mode. See section 1.9 for how to change the display mode.

2. Place the cursor on the indication you wish to adjust.
3. Left-click, or spin the scrollwheel, to adjust the settings as required. The settings options are outlined in the table below.

Indication	Method	Settings options
CPA	Left-click	0.5, 1, 1.5, 2, 3, 4, 5, 6 (NM)
	Scrollwheel	0.1 to 20; 0 to 10 in 0.1 NM increments, 1 NM increments thereafter
TCPA	Left-click	1, 2, 3, 4, 5, 6, 12, 15 (minutes)
	Scrollwheel	1 to 60 minutes in 1-minute increments

3.13.2 How to acknowledge the TT collision alarm

Press the **ALARM ACK** (RCU-014) or **ALERT ACK** (RCU-031) key on the control unit, or select the [ALERT] box with the trackball then left-click to acknowledge the alarm and silence the buzzer. The alert "TT DANGER OF COLLISION" remains in the Alert Box until the dangerous situation is gone or you intentionally terminate target tracking. The symbol and vector stop flashing and are displayed in a solid red color.

Note that when the "TT DANGER OF COLLISION" alarm is generated the AIS display is automatically turned on.

3.14 Acquisition Zone

The acquisition zone functions both to alert you targets in a specific area and acts as an automatic acquisition area when automatic target acquisition is active. Any targets entering the zone will be automatically acquired.

When a target enters an acquisition zone, the buzzer sounds and the indication "TT NEW TARGET" (or "AIS NEW TARGET") appears (in yellow-orange) in the Alert Box. The symbol of the offending target is red and flashing. Further, the AIS display is automatically turned on if it is off.

There are two types of acquisition zones available, arc and polygon, however, AZ1 can only be set as an arc.

3.14.1 How to enable the acquisition zones

1. Open the menu.
2. Select [5 TT•AIS].
3. Select [2 ACQUISITION ZONE].

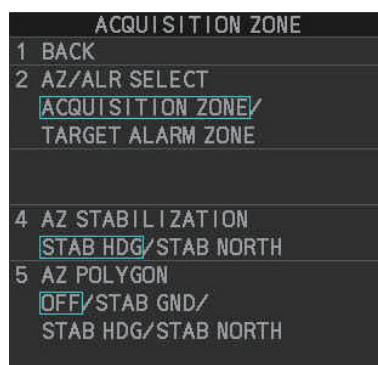

4. Select [2 AZ/ALR SELECT].
5. Select [ACQUISITION ZONE].
The [ACQUISITION ZONE] box title changes to read "AZ".



6. Close the menu.

3. TARGET TRACKING (TT)

3.14.2 How to activate the first acquisition zone (AZ1)

The No. 1 acquisition zone is available between 3 NM and 6 NM and can have a width between 0.5 NM and 1 NM. The TT/AIS acquisition zone's lines are white and dashed so as to distinguish them from the radar target alarm.

The procedure below shows how to set AZ1, using the example at the bottom of the page.

1. Place the cursor on the [1:] indication at the bottom-right of the screen, then left-click. The AZ zone setting reads "1: SET" and the cursor moves inside the operational display area.
2. Place the cursor on the acquisition zone starting point ("A" in the figure to the right), then left-click.
3. Place the cursor on the acquisition zone end point ("B" in the figure to the right), then left-click. The AZ zone setting now reads "1: WORK".

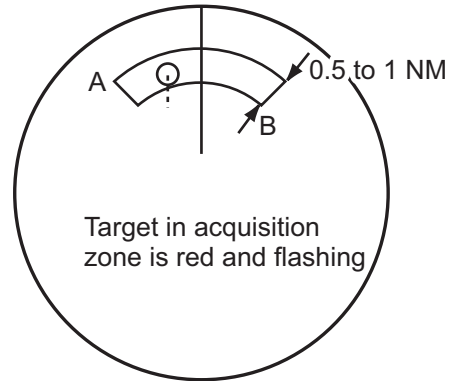

3.14.3 How to set a polygon acquisition zone (AZ2)

Note: This procedure is not available if [5 AZ POLYGON] in the [ACQUISITION ZONE] menu is set to [OFF].

The No. 2 acquisition zone can be set anywhere when the No. 1 zone is already in use.

Polygon zones must have at least three points, and may have a total of 10 points.

To set a polygon shaped acquisition zone:

1. Place the cursor on the [2:] indication at the bottom-right of the screen, then left-click. The AZ zone setting reads "2: SET" and the cursor moves inside the operational display area.
2. Place the cursor on the acquisition zone starting point, then left-click.
3. Place the cursor on the second point, then left-click.
4. Repeat step 3 as required to set the remaining points of the polygon zone.
5. Right-click to complete the acquisition zone set up.

Note: If 10 points are entered, the zone is automatically completed.

Notes on acquisition zones

- If you wish to create an acquisition zone having a 360-degree coverage around own ship, set point B in almost the same direction (approx. $\pm 3^\circ$) as point A.
- The default acquisition zone is fan shaped. It can also be a polygon having 3-10 points.
- If both acquisition zones are displayed, a maximum of four polygon points are shown.
- TT and AIS are automatically set to TT=AUTO MAN and AIS=DISP, respectively, when an AZ is activated in the following conditions:
TT: TT=OFF or TT=MANUAL 100
AIS: AIS FUNC=OFF or AIS DISP=OFF

3.14.4 How to sleep/deactivate an acquisition zone

1. Select the appropriate [AZ] box.
2. Sleep, or deactivate, the acquisition zone, as explained below:

Sleeping the acquisition zone

Left-click the box several times until the indication shows "SLEEP".

Deactivating the acquisition zone

Highlight the box with the cursor, then press and hold the **left-button** until the AZ box becomes blank.

Note: When both zones ([1:] and [2:]) are active, [2:] must be deactivated before [1:] can be deactivated.

If [1:] and [2:] are active when you try to deactivate [2:], the system releases an audible alert and shows the message "DELETE AZ2 FIRST".

3.14.5 How to acknowledge the acquisition zone alert

You can acknowledge the alert, and silence the buzzer, with one of the following methods:

- Press the **ALARM ACK** (RCU-014) or **ALERT ACK** (RCU-031) key;
- Highlight the [ALERT] box with the cursor, then left-click;
- Highlight the alert in the [ALERT LIST], then left-click.

3.14.6 How to select the target type to acquire (C-types only)

You can set the radar to acquire on TT targets, or both AIS and TT targets. To select the target type to acquire, do the following:

1. Open the menu.
2. Select [5 TT•AIS].
3. Select [2 ACQUISITION ZONE].
4. Select [3 TARGET TYPE TO ACQUIRE].
5. Select [TT AND AIS] or [TT ONLY] as appropriate.
6. Close the menu.

3.14.7 How to change the acquisition zone reference

The acquisition zone can be referenced to heading or North using the following procedure:

1. Open the menu.
2. Select [5 TT•AIS].
3. Select [2 ACQUISITION ZONE].
4. Select [4 AZ STABILIZATION].
5. Select [STAB HDG] to reference heading, or [STAB NORTH] to reference North, then press the **ENTER MARK** key.
6. Close the menu.

3. TARGET TRACKING (TT)

3.14.8 How to set acquisition zone shape and stabilization

The shape of the No. 2 acquisition zone can be a sector or a polygon having up to 10 points. (The shape of the No.1 acquisition zone is always a sector.)

1. Open the menu.
2. Select [5 TT•AIS].
3. Select [2 ACQUISITION ZONE].
4. Select [5 AZ POLYGON].
5. Select the appropriate setting.

Setting	Description
[OFF]	Acquisition zone is a sector; number of points is limited to four. Stabilized against land.
[STAB GND]	Polygon having 3-10 points. Stabilized against ground.
[STAB HDG]	Polygon having 3-10 points. Stabilized against heading.
[STAB NORTH]	Polygon having 3-10 points. Stabilized against North.
[AROUND CHECK AREA]*	Sets a check area around own ship. See the topic on the following page for details and settings.

*: Shown only for C-types.

6. Close the menu.

How to set the check area around own ship (C-type only)

When [5 AZ POLYGON] is set to [AROUND CHECK AREA], the area details must be set. To setup the check area, do the following procedure. This procedure is abbreviated, and takes into consideration that [AROUND CHECK AREA] is selected.

1. Select [6 CHECK AREA SETTING].
2. Referring to the figure below, use the number keys to enter a distance for [PORT], [STBD], [BOW] and [STERN]. You can also spin the scrollwheel, then left-click to enter these values.

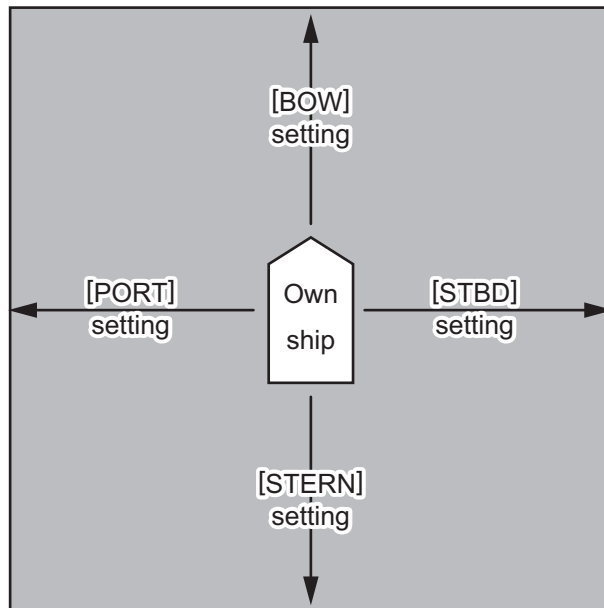

The area shown in gray is the "check area".

The available setting range for all four values is [0.0NM] to [16.0NM]. The default setting for all four values is [1.0NM].

3.15 Trial Maneuvers (IMO-types only)

The trial maneuver feature simulates the effect of own ship's movement against all tracked targets, without interrupting the updating of target information. It is available for use with the TT and AIS functions. For more accurate results, use sea stabilization (water tracking).

3.15.1 Types of trial maneuvers

There are two types of trial maneuvers: dynamic and static.

Dynamic trial maneuver

A dynamic trial maneuver displays predicted positions of the tracked targets and own ship. You enter own ship's intended speed and course with a certain "delay time." Assuming that all tracked targets maintain their present speeds and courses, the targets' and own ship's future movements are simulated in 0.5-second increments indicating their predicted positions in 30-second intervals as illustrated in the right figure.

The delay time represents the time lag from the present time to the time when own ship will actually start to change her speed and/or course. You should therefore take into consideration own ship's maneuvering characteristics such as rudder delay, turning delay and acceleration delay. This is particularly important on large vessels. Regardless of how much the delay is set the situation starts immediately and ends in a minute.

In the example shown below, own ship will advance straight ahead (even after a maneuver) for a delay time of 2:30 and alters speed and course until operator-specified intended speed and course are achieved (position OS7 in this example).

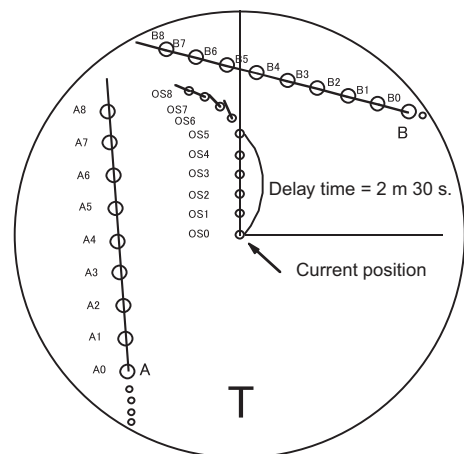

3. TARGET TRACKING (TT)

Static trial maneuver

The static trial maneuver shows the relationship between your ship and tracked targets at the completion of the trial maneuver. The expected position of TTs at the end of the trial maneuver are shown on the display.

By shortening and extending the trial time you can find the safe time to make a maneuver. Thus, the static trial maneuver will be convenient when you wish to know the maneuver result immediately.

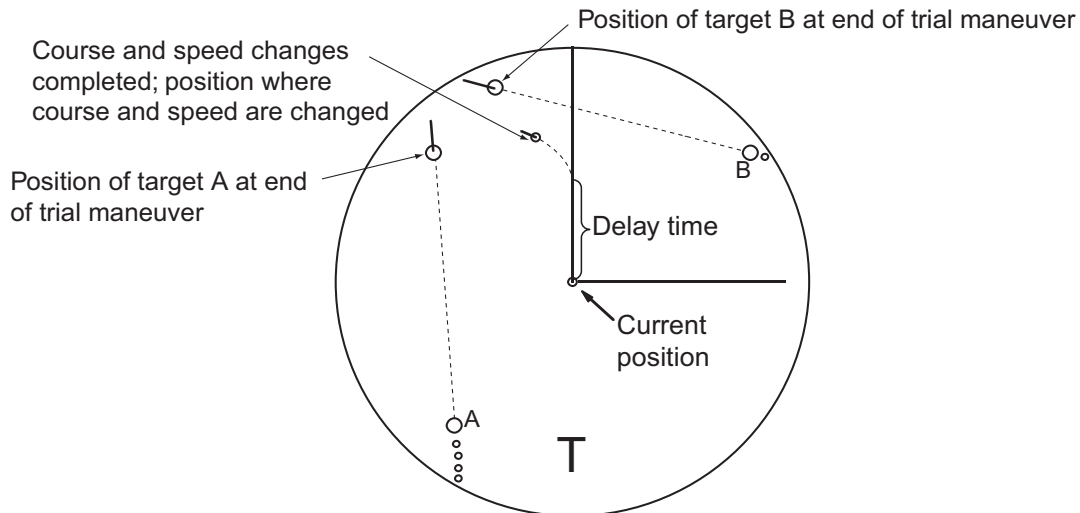

3.15.2 How to perform a trial maneuver

To set up and perform a trial maneuver, do the following:

1. Open the menu.
2. Select [5 TT•AIS].
3. Select [3 TRIAL MANEUVER].
4. Select [2 TRIAL MANEUVER].
5. Select [OFF], [STATIC] or [DYNAMIC] as appropriate.
6. Select [3 SPEED RATE].
7. Set the upper and lower speed rate as required.
8. Select [4 TRIAL TURN RATE].
9. Set the upper and lower turn rate for the trial as required.

TRIAL MANEUVER	
1	BACK
2	TRIAL MANEUVER
	OFF/STATIC/DYNAMIC
3	TRIAL SPEED RATE
	0kn 0.00kn/s
	0kn 0.00kn/s
4	TRIAL TURN RATE
	0kn 0.0°/s
	0kn 0.0°/s

Note: Two sets of trial speed and trial turn rate combinations are provided. This is done to provide accurate trial maneuver results for various ship's speeds and turn rates.

Setting example for [3 TRIAL SPEED RATE]

5 kn, 0.15 kn/s
10 kn, 0.45 kn/s

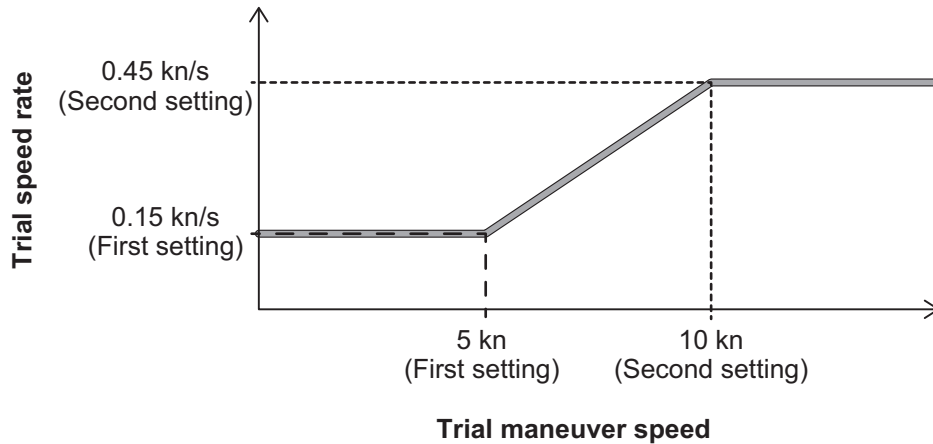

Setting example for [4 TRIAL TURN RATE]

5 kn, 1.5 °/s
10 kn, 4.5 °/s

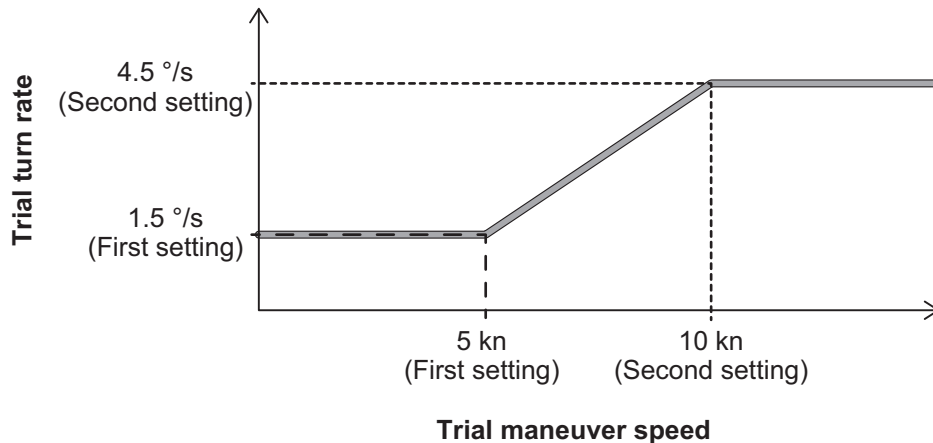

10. Close the menu
11. Highlight the [TRIAL] status indication in the [TRIAL] box, then left-click. The indication changes from "OFF" to "SET" and the trial maneuver settings appear.

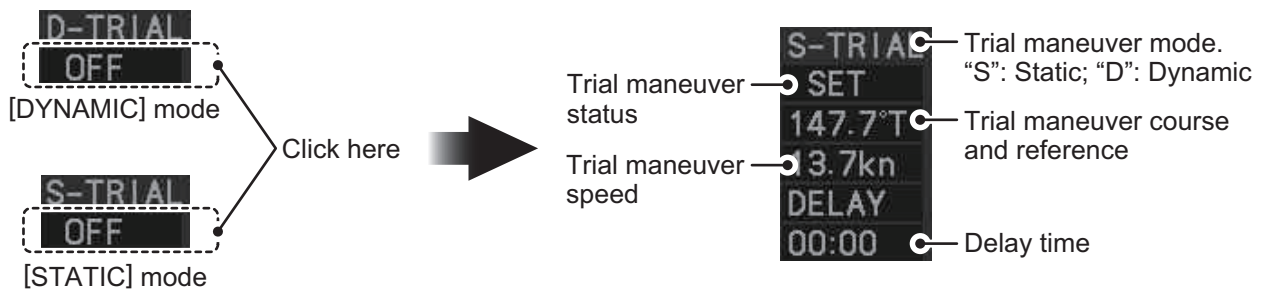

Note: The initial indications for course and speed are derived from own ship's current course and speed at the time when the trial maneuver set up starts.

12. Select the trial maneuver course and reference indication, then left-click.
13. Spin the scrollwheel to set the course, then left-click. The reference is not changeable here.
14. Set the speed in the same manner as the course.

3. TARGET TRACKING (TT)

15. Select the delay time indication, then left-click.
16. Spin the scrollwheel to set the amount of delay. This is the time after which own ship takes a new situation, not the time the simulation begins. Change the delay time according to own ship loading condition, etc.
The time indication depends on trial type:
[DYNAMIC]: The position of your ship and TTs is displayed every 30 seconds and updating occurs every 0.5 seconds.
[STATIC]: The position of your ship and TTs when set course and speed are reached are displayed. Put the cursor in the Trial time indication and roll the scrollwheel. Increase or decrease the time to get a safe maneuver. If a maneuver is unsafe, change speed, course and delay until it is safe.
17. Highlight the [TRIAL] status indication, then left-click. The indication changes from "SET" to show a timer for the trial maneuver and the maneuver begins.

The trial maneuver takes place with the letter "T" displayed at the bottom of the screen. The time appears at the top-right position on the display. If any TT is predicted to be on a collision course with own ship (that is, the target ship comes within preset CPA/ TCPA limits), the target plotting symbol flashes. If this happens, change own ship's trial speed, course or delay time to obtain a safe maneuver.

3.15.3 How to stop the trial maneuver

You can stop the maneuver at any time by placing the cursor on the [TRIAL] status indication, then press and hold the left mouse button until "OFF" is shown.

When [DYNAMIC] is selected as the maneuver type, the maneuver automatically stops when the trial timer reaches 60 minutes.

When [STATIC] is selected as the maneuver type, the maneuver automatically stops when there is no operation of the [TRIAL] box for more than one minute.

3.16 TT System Messages

There are four main reasons the TT may trigger the audio and visual alerts:

- Collision alarm
- Acquisition zone alert
- Lost target alert
- Target capacity

You can acknowledge visual alerts and silence the audio alerts with one of the following methods:

- Press the **ALARM ACK** (RCU-014) or **ALERT ACK** (RCU-031) key
- Click the [ALERT] box, at the bottom-right of the screen.
- Click the alert in the [ALERT LIST].

Alert message	Priority	Meaning	Action required
TT DANGER OF COLLISION	Alarm	A tracked target is on collision course with your vessel.	Take evasive action or terminate tracking of TT.
TT NEW TARGET	Warning	Tracked target has entered an acquisition zone. The tracked target's symbol is red and flashing.	Confirm the tracked target, then press the ALARM ACK (RCU-014) or ALERT ACK (RCU-031) key.
TT TARGET LOST	Warning	When the system detects a loss of a tracked target, the lost tracked target symbol appears in red and flashes. At the same time, an audio alert is produced for one second. The lost target mark disappears from the screen after the lost target alert is acknowledged.	Confirm the lost target, reacquire if necessary.
REF TARGET LOST	Warning	When the system detects a loss of a reference target, the target symbol turns red and flashes. At the same time, an audio alert is produced for one second. The reference target mark disappears from the screen after the reference target alarm is acknowledged.	To continue using a referenced target for speed input, select another tracked target.
TT TARGET FULL (AUTO) or (MAN)	Warning	Appears when capacity for automatically (manually) acquired targets is full.	To continue acquiring targets, cancel tracking for unnecessary targets.
TT TARGET 95% (AUTO) or (MAN)	Caution	Appears when capacity for automatically (manually) tracked targets is 95% full.	

3.17 TT Simulation Mode

You can simulate the risk of a collision by using the TT simulation mode. This function can be used for familiarization training for your crew. The simulation can be terminated at any time by pressing the **STBY TX** key.

1. Open the menu.
2. Select [9 INITIAL SETTINGS].
3. Select [7 TESTS].
4. Select [4 TT SIMULATION MODE].

The normal operation is suspended then three simulated targets appear on the display.

The indication "S" appears at the bottom of the effective display area during the simulation mode. The simulation may be terminated any time by going to the STBY mode.

Three simulated targets move as the following table. The simulated target is automatically generated with the relative movement in the following table based on own ship's movement at the start of simulation mode.

Note: If own ship moves after the start of simulation mode, the movement of the simulated target is not matched with the values in the following table.

	Range (R)	Bearing (R)	Speed (R)	Course (R)	CPA	TCPA
Target 01	9.5 NM	270.0°	20.0 kn	90.0°	0.0 NM	28.5 min
Target 02	1.1 NM	333.0°	10.2 kn	90.2°	1.0 NM	2.9 min
Target 03	9.3 NM	45.0°	19.9 kn	225.1°	0.0 NM	28.0 min

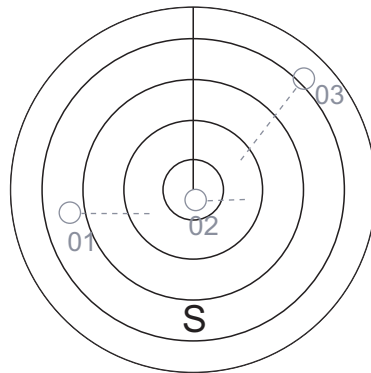

Place the cursor on a target, then press the **ACQ** key to display the target data.

Acquire the simulated targets after the TT simulation mode is performed. The tracking state changes from unstable to stable and the vector appears. You can simulate the movement of each function with changing true/relative vector, stabilization through the water/over the ground, range or length of vector.

Repeat the check for all targets.

3.18 Criteria for Tracking Target Selection

The FURUNO TT video processor detects targets in midst of noise and discriminates radar echoes on the basis of their size. Target whose echo measurements are greater than those of the largest ship in range or tangential extent are usually land and are displayed only as normal radar video. All smaller ship-sized echoes that are less than this dimension, are further analyzed and regarded as ships and displayed as small circles superimposed over the video echo.

When a target is first displayed, it is shown as having zero true speed but develops a course vector as more information is collected. In accordance with the International Marine Organization Automatic Radar Plotting Aid (IMO TT) requirements, an indication of the motion trend should be available within 20 scans of antenna and full vector accuracy within 60 scans. The FURUNO TTs comply with these requirements.

Acquisition and tracking criteria

A target which is hit by five consecutive radar pulses, is detected as a radar echo. Manual acquisition is done by designating a detected echo with the trackball. Automatic acquisition is done in the acquisition areas when a target is detected 5-7 times continuously depending upon the congestion. Tracking is achieved the target is clearly distinguishable on the display for 5 out of 10 consecutive scans, whether acquired automatically or manually. Required tracking facilities are available within 0.1-32 nm on range scales including 3, 6, 12 nm, full plotting information is available within one scan when the range scale has been changed.

Targets not detected in five consecutive scans become "lost targets".

Quantization

The entire picture is converted to a digital form called "Quantized Video". A sweep range is divided into small segments and each range element is "1" if there is radar echo return above a threshold level, or "0" if there is no return.

The digital radar signal is then analyzed by a ship-sized echo discriminator. As the antenna scans, if there are five consecutive radar pulses with 1's indicating an echo presence at the exact same range, a target "start" is initiated. Since receiver noise is random, it is not three-bang correlated, and it is filtered out and not classified as an echo.

The same is true of radar interference. Electronic circuits track both the closet and most distant edges of the echo. At the end of the scanning of the echo, the discriminator indicates the measured maximum range extent and total angular extent subtended by the echo. If the echo is larger than a ship-sized echo in range extent and/or angular width, adjusted as a function of range, it is declared to be a coastline and the closet edge is put into memory as a map of the area.

This land outline is used to inhibit further acquisition and tracking of ship-sized echoes beyond the closest coast outline. Five consecutive scans of coastal outline are retained in memory to allow for signal variation. All smaller echoes are declared to be ship sized and the middle of the leading edge is used to provide precise range and bearing co-ordinates of each echo on every scan. This range/bearing data is matched to previous data and analyzed from scan-to-scan for consistency. When it is determined to be as consistent as a real target, automatic acquisition occurs and tracking is initiated. Continued tracking and subsequent calculation develop the relative course and speed of the target.

3. TARGET TRACKING (TT)

The true course and speed of own ship are computed from own ship's gyro and speed inputs, and the resulting course and speed of each tracked target is easily computed by vector summing of the relative motion with own ship's course and speed. The resulting true or relative vector is displayed for each of the tracked targets. This process is updated continually for each target on every scan of the radar.

Qualitative description of tracking error

The FURUNO TT's accuracy complies with or exceed IMO standards.

Own ship maneuvers

For slow turns there is no effect. For very high turning rates (greater than 150°/minute, depending on gyro), there is some influence on all tracked targets that lasts for a minute or two then all tracked targets revert to full accuracy.

Other ship maneuvers

Target ship courses, lag 15 to 30 seconds at high relative speed, or 3 to 6 seconds at low (near 0) relative speed. It is less accurate during a turn due to lag, but accuracy recovers quickly.

3.19 Factors Affecting Target Tracking

Sea returns

If the radar anti-clutter control is adjusted properly, there is no serious effect because distant wave clutter, not eliminated by this control, is filtered out by more than one bang correlation and scan-to-scan matching of data.

Rain and snow

Rain clutter can be acquired and tracked as targets. Adjust the rain clutter control to suppress the clutter. If it is heavy rain, switch to S-band if provided, or switch on the interference rejector on the radar. If heavy clutter still exists, switch to manual acquisition. Accuracy can be affected.

Low clouds

Usually no affect. If necessary, adjust the rain clutter control.

Non-synchronous emissions

No effect.

Low gain

Insufficient or low radar receiver gain will result in some targets not being acquired at long distance. The TT display will be missing on one or more targets that could only be visible if the radar sensitivity control (**GAIN** control) were increased.

The setting of the correct radar receiver gain is not critical but the target should be on the radar PPI and be clearly visible and well defined.

Manual acquisition is done if a target is positively displayed more than once. Automatic acquisition is done when the target is detected 5-7 times continuously.

Tracking continues if a return echo is received at least once in nine antenna rotations. However, the fewer the return echoes the lower the accuracy. If no return echo is received within nine antenna rotations the target is declared a lost target.

Second trace echoes

When the radar beam is super refracted, strong echoes may be received at such long ranges that they appear on a different timebase sweep than the transmitted pulse. This gives an incorrect range indication. Second- and third-trace echoes can be tracked if they are consistent enough to meet acquisition and tracking criteria but target course and speed data will be in error.

Blind and shadow sectors

Radar shadow or blind areas caused by obstructions aboard the ship, for example, funnels and masts, in the path of the radar beam can result in reduction of radar beam intensity in that particular direction. This may eliminate the detection of some targets. The TT system will lose track of targets shortly after they are lost on the radar picture and if they remain in a blind zone. These targets will however be acquired and tracked when they pass out of the blind zone and again present normal radar echo. The angular width and bearing of any shadow sector should be determined for their influence on the radar. In certain cases false echoes in the shadow sector cause the TT system to acquire, track, and vector them. Shadow sectors should be avoided.

Indirect echoes

A target at close range is usually picked up directly, but it can also be received as reflection from a large, flat surface. This will result in the radar presenting two or more echoes on the display, each at a different range. The TT system can acquire and track a false echo if it is detected in five consecutive scans. Reduction in radar gain can eliminate the multiple echoing but care should be taken as range detection also will be reduced.

Radar interference

If interference is extreme due to another radar operating at close range, spiral "dotting" and/or false targets may appear momentarily. The interference rejector can clear the display.

Delay of sensor input

If the refresh rate of the gyrocompass signal is too slow, error in target bearing occurs when own ship turns. To prevent this error, the refresh rate of the gyrocompass signal must be as indicated in the System Configuration drawings.

3. TARGET TRACKING (TT)

This page is intentionally left blank.

4. AIS OPERATION

An AIS transponder can be connected to this radar to overlay AIS targets on the radar display. The radar can store up to 1,200 AIS targets in its storage buffer. When this buffer becomes full of AIS targets, the Alert "AIS CAPACITY FULL" is generated to alert you to a full storage buffer. The storage buffer contains automatic dead reckoning for all AIS targets, which is based on reported Speed Over the Ground (SOG) and Course Over the Ground (COG). The storage buffer also contains calculation of range, bearing, CPA, TCPA, etc. The CPA and TCPA limits set for dangerous targets are common for TT and AIS targets.

This radar can activate 50 AIS targets. The Alert "ACTIVE AIS FULL" is generated when 50 AIS targets are activated.

This radar can display a maximum of 350 AIS targets. The Alert "AIS DISPLAY FULL" is generated when 350 AIS targets, which includes both activated and sleeping targets, are displayed.

The frequency for update of AIS transponder-sent data depends on speed and course of tracked AIS target. The table below shows the IMO standardized reporting rates for the AIS transponder. Based on the table below, the radar defines which AIS targets are in tracking or lost. When you acknowledge a lost target alert, the corresponding AIS symbol will be removed from the display.

Type of Ship	IMO nominal reporting interval	Lost target indication (reporting interval >)
Class A: Navigation status is "anchor" or "not under command" or "moored" or "aground", and SOG \leq 3kn	3 min	10 min
Class A: Navigation status is "anchor" or "not under command" or "moored" or "aground", and SOG > 3kn	10 s	50 s
Class A: 0kn \leq SOG < 14kn	10 s	50 s
Class A: 14kn \leq SOG \leq 23kn	6 s	30 s
Class A: SOG > 23kn	2 s	10 s
Class B: "CS" SOG \leq 2kn	3 min	10 min
Class B: "CS" SOG > 2kn	30 s	150 s
Class B: "SO" 0 kn \leq SOG \leq 2kn	3 min	10 min
Class B: "SO" 2 kn < SOG < 14kn	30 s	150 s
Class B: "SO" 14 kn \leq SOG \leq 23kn	15 s	75 s
Class B: "SO" SOG > 23kn	5 s	25 s
Class A and Class B: no SOG available	N/A	10 min
AIS SAR aircraft	10 s	50 s
AIS aid to navigation	3 min	10 min
AIS base station	10 s	50 s
AIS search and rescue transponder	N/A	10 min

An AIS transponder "sees" all ships fitted with an AIS transponder belonging to either a Class A or Class B AIS. Additionally, the AIS transponder receives messages from ships and non-ships (AIS SAR aircraft, AIS aid to navigation, AIS base station, and AIS search and rescue transmitter).

4. AIS OPERATION

There can be several hundreds or several thousands of AIS targets, and of those only a few will be significant for your ship. To remove unnecessary AIS targets from the radar display, the feature "active and sleeping AIS targets" is available. Initially any new AIS target received by an AIS transponder is not active (= "sleeping"). Such sleeping targets are shown with a small triangle. The operator can pick any AIS target and change it from sleeping to active (see section 4.5 and section 4.6), or filter the targets to display on-screen (see section 4.4). Active AIS targets are shown with a large triangle with speed vector, headline, ROT indicator, etc. Further, the operator can pick active AIS targets and change their status to sleeping.

An indication of AIS target activated capacity limit is given well before it is reached. When 95% of 50 targets are activated, the Alert "ACTIVE AIS 95%" appears. When 50 targets are activated, the Alert "ACTIVE AIS FULL" appears. Sleep any unnecessary AIS targets to allow acquisition of new targets.

An indication of AIS target display capacity limit is given well before it is reached. When 95% of 350 targets are displayed, the Alert "AIS DISPLAY 95%" appears. When 350 targets are displayed, the Alert "AIS DISPLAY FULL" appears.

An indication of AIS target processing capacity limit is given well before it is reached. The Alert "AIS CAPACITY FULL" appears when 1,200 targets are in the storage buffer. When capacity-related AIS alerts occur, you can reduce the number of AIS targets to display from [AIS DISP FILTER] in the [AIS] menu. See section 4.4.

This radar generates AIS-related alerts. These are Alert "AIS DANGER OF COLLISION" and Alert "AIS TARGET LOST". Only active AIS targets generate alerts. The operator can activate or sleep AIS target alerts as desired. The feature "active and sleeping AIS targets" is very effective for focusing on only those AIS targets that need supervision. This radar further eases the task of the operator by automatically changing non-active targets to active targets, if their CPA and TCPA are within a preset limit.

4.1 Controls for AIS

The control unit has three keys that are used in the AIS mode. The keys are indicated in the figure below.

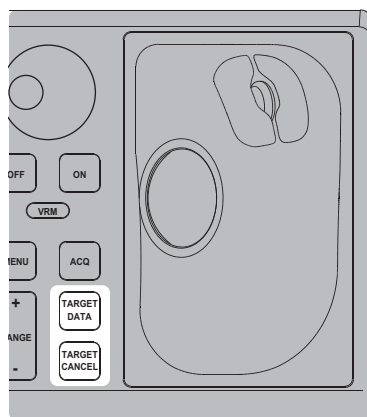

RCU-014

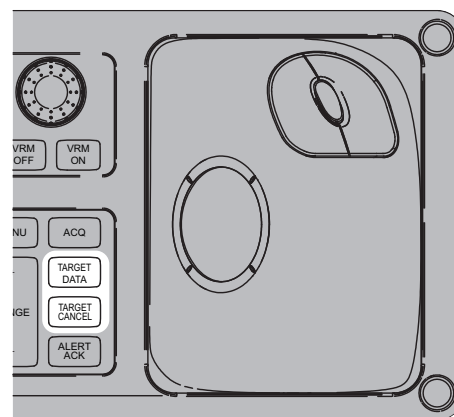

RCU-031

- **TARGET DATA:** Shows the selected target's data in the information box. If the target is sleeping, activates the target.
- **TARGET CANCEL:** Sleeps the cursor-selected target.

These functions, along with other AIS functions, can also be accessed from the [CURSOR] menu (See section 1.7.3).

4.2 How to Select the AIS Display Mode



- [DISP OFF]: AIS symbols are hidden.
- [DISP FILT]: Only filtered AIS targets are displayed.
- [DISP ALL]: All AIS symbols are displayed.

To disable the AIS function, put the cursor on the AIS display mode indication, then long right-click. The AIS display mode indication shows [FUNC OFF] when the AIS function is disabled.

Note: The AIS mode indication is hidden when [SIMPLE] display mode is used. To change AIS settings in [SIMPLE] mode, first restore [NORMAL] display mode, adjust the settings, then return to [SIMPLE] mode. See section 1.9 for how to change the display mode.

4.3 AIS Symbols and Their Meanings

When the AIS display is active, each AIS target is marked with a symbol that indicates the target's status. For the meaning of each AIS symbol, see "TT/AIS symbols" on page AP-34.

Note 1: The equipment continues to process AIS targets when the AIS feature is deactivated. When the AIS is activated again, symbols are immediately displayed.

Note 2: AIS symbols are momentarily erased and the screen is redrawn after the heading is changed in the HEAD UP mode.

Note 3: When no AIS data is received, the message "AIS COM ERROR" appears in the Alert Box. Check connection with the AIS transponder.

When the AIS function is disabled: Above message is prioritized as a Caution level alert.

When the AIS function is active: Above message is prioritized as a Warning level alert.

4.4 How to Use the AIS Display Filter

If there are too many AIS targets on the screen you may wish to remove unnecessary ones. You can remove sleeping targets class A/B by distance from own ship, speed and class. For example, you might want to remove slow moving targets, as they normally do not require close monitoring.

1. Open the menu.
2. Select [5 TT•AIS].
3. Select [4 AIS].

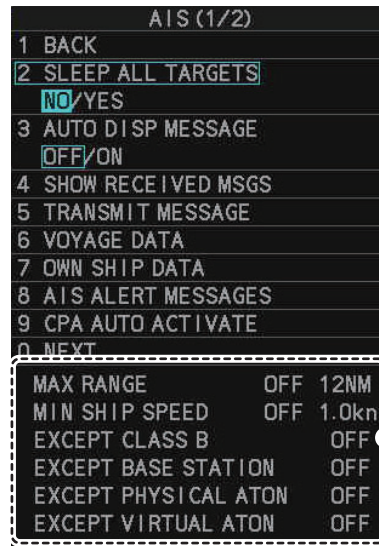

Note: You can also right-click the AIS indication in the [TT•AIS] box to open the [TT] menu.

4. Select [0 NEXT] to show the next menu page.



5. Select [2 AIS DISP FILTER].

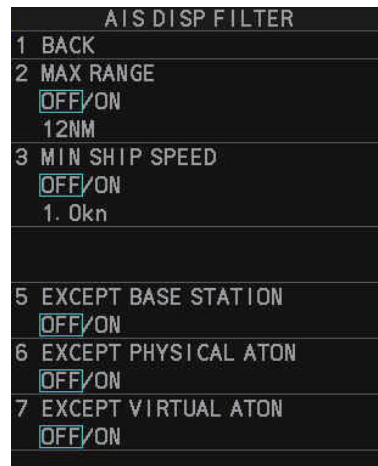

6. Referring to the table below, select the appropriate filter.

Filter type	Definition
[MAX RANGE]	Any sleeping AIS targets class A/B beyond the range set here will not be shown.
[MIN SHIP SPEED]	Any sleeping AIS targets class A/B slower than this setting will not be shown.
[EXCEPT CLASS B]*	Select [ON] to remove sleeping AIS targets class B.
[EXCEPT BASE STATION]	Select [ON] to remove the BASE STATION symbol.
[EXCEPT PHYSICAL ATON]	Select [ON] to remove the AIS PHYSICAL ATON symbol.
[EXCEPT VIRTUAL ATON]	Select [ON] to remove the AIS VIRTUAL ATON symbol.

*: This menu item appears only on C-type radars.

7. Do one of the following depending on your selection at step 6.

- [MAX RANGE]: Select [ON], spin the scrollwheel to set the maximum range (00 to 99 N), then click to confirm selection.
- [MIN SHIP SPEED]: Select [ON], spin the scrollwheel to set the minimum speed (0.0 to 9.9 kn), then click to confirm selection.
- [EXCEPT CLASS B], [EXCEPT BASE STATION], [EXCEPT PHYSICAL ATON], [EXCEPT VIRTUAL ATON]: Select [ON] to hide the corresponding AIS target.

8. Close the menu.

Set the AIS display mode to [DISP FILT] to show only the AIS symbols selected for display on the [AIS DISP FILTER] menu.

Note: This function is not available for an activated target.

4.5 How to Activate AIS Targets

When you convert a sleeping target to an activated target, that target's course and speed are shown with a vector. You can easily judge target movement by monitoring the vector.

Sleeping targets within an acquisition zone are automatically changed to activated targets and are colored red. See section 3.14 for how to use acquisition zones.

4.5.1 How to activate specific targets manually

Note: Enable target data and acquisition beforehand.

Right click to show the [CURSOR] menu→[0 NEXT]→[TGT DATA/ACQ SETTING]→[ANY] or [AIS ONLY].

Activate an AIS target from the control unit (RCU-014/RCU-031)

Put the cursor on the symbol of the AIS target to activate, then press the **TARGET DATA** key.

Activate a AIS target with the trackball

Put the cursor on the symbol of the AIS target to activate, then click.

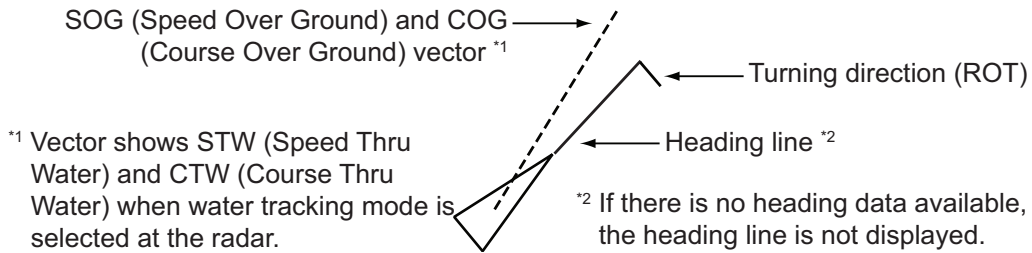

4.5.2 How to set the AIS auto activate function

You can limit the function of the AIS auto activate function by distance from own ship, ship's speed, ship class, and ship's length.

How to set the AIS auto activate function

1. Open the menu.
2. Select [5 TT•AIS].
3. **For IMO-types**, select [5 AIS].
For C-types, select [4 AIS].
4. Select [9 CPA AUTO ACTIVATE] to show the [CPA AUTO ACTIVATE] menu.

CPA AUTO ACTIVATE	
1	BACK
2	MAX RANGE OFF/ON OONM
3	MIN SHIP SPEED OFF/ON 1. 0kn
4	EXCEPT CLASS B OFF/ON

5. Referring to the table below, select the appropriate filter, then left-click.

Filter type	Definition
[MAX RANGE]	Any AIS targets beyond the range set here will not be automatically activated.
[MIN SHIP SPEED]	Any AIS targets slower than this setting will not be automatically activated.
[EXCEPT CLASS B]	Select [ON] to prevent activation of AIS targets class B.

6. Do one of the following depending on your selection at step 5.
 - [MAX RANGE]: Select [ON], spin the scrollwheel to set the maximum range (00 to 99 N), then click to confirm selection.
 - [MIN SHIP SPEED]: Select [ON], spin the scrollwheel to set the minimum speed (0.0 to 9.9 kn), then click to confirm selection.
 - [EXCEPT CLASS B], [EXCEPT BASE STATION], [EXCEPT PHYSICAL ATON], [EXCEPT VIRTUAL ATON]: Select [ON] to hide the corresponding AIS target.
7. Close the menu.

How to enable/disable the AIS auto activate function

Use the [CPA AUTO ACTIVATE] box at the bottom right corner to enable or disable the AIS auto activate function.



Note: The AIS CPA setting is hidden when [SIMPLE] display mode is used. To change the setting in [SIMPLE] mode, first restore [NORMAL] display mode, adjust the setting, then return to [SIMPLE] mode. See section 1.9 for how to change the display mode.

1. Place the cursor on the [CPA AUTO ACTIVATE] box, then left-click display to cycle through the auto activate settings.

Filter type	Definition
[OFF]	Disable the AIS auto activate function.
[AUTO ACT FILT]	Activation against AIS targets which meet the following criteria: <ul style="list-style-type: none"> • AIS target that meets the criteria set with [CPA AUTO ACTIVATE] on the [TT•AIS] menu. • CPA or TCPA of an AIS target is smaller than that set in section 3.13.
[AUTO ACT ALL]	Activation against AIS targets whose CPA or TCPA is less than set in section 3.13

4.6 How to Sleep AIS Targets

You can “sleep” an AIS target as below when the screen becomes filled with radar echoes and TTs, which might prevent important radar and AIS displays from being identified.

Note: Targets that have been activated automatically and dangerous targets cannot be “slept”.

4.6.1 How to sleep individual AIS targets

Note: Enable target data and acquisition beforehand.

Right click to show the CURSOR menu→[0 NEXT]→[TGT DATA/ACQ SETTING]→[ANY] or [AIS ONLY].

Sleep a AIS target from the control unit (RCU-014/RCU-031)

Place the cursor on the symbol of the AIS target to sleep, then press the **TARGET CANCEL** key.

Sleep a AIS target with the trackball

1. Place the cursor inside the operational display area, then right-click. The [CURSOR] menu appears.
2. Select [TARGET CANCEL].
3. Place the cursor on the symbol of the AIS target to sleep, then click.

4.6.2 How to sleep all AIS targets

1. Open the menu.
2. Select [5 TT•AIS].
3. Select [5 AIS].
4. Select [2 SLEEP ALL TARGETS].
5. Select [YES] or [NO] as appropriate.
6. Close the menu.

4.7 How to Set Up For a Voyage

At the start of a voyage, following five items must be input from the [VOYAGE DATA] menu: navigational status, ETA, destination, draught and crew.

4.7.1 How to access the [VOYAGE DATA] menu

There are two methods by which you can access the [VOYAGE DATA] menu: from the InstantAccess bar™, or from the menu. The following procedure shows the menu method. If you click the [OWN AIS] button on the lower half of the InstantAccess bar™, skip to step 5 in the below procedure.

1. Open the menu.
2. Select [5 TT•AIS].
3. Select [5 AIS].
4. Select [6 VOYAGE DATA].

VOYAGE DATA	
1	BACK
2	NAV STATUS 05 MOORED
3	ETA --/--/--/---- --:--
4	DESTINATION
5	DRAUGHT 0.0m
6	PERSONS 0000
7	OPEN DESTINATION 1
8	SAVE DESTINATION 1

5. Select [2 NAV STATUS].
6. Spin the scrollwheel to select the navigation status number, then left-click.

Nav Status No.	Meaning
00	UNDERWAY USING ENGINE
01	AT ANCHOR
02	NOT UNDER COMMAND
03	RESTRICTED MANEUVERABILITY
04	CONSTRAINED BY HER DRAUGHT
<i>Continued on following page</i>	

Nav Status No.	Meaning
<i>Continued from previous page</i>	
05	MOORED (DEFAULT)
06	AGROUND
07	ENGAGED IN FISHING
08	UNDER WAY SAILING
09	RESERVED FOR HIGH SPEED CRAFT (HSC)
10	RESERVED FOR WING IN GROUND (WIG, FOR EXAMPLE, HYDROFOIL)
11	POWER-DRIVEN VESSEL (AHEAD/ASTERN)
12	POWER-DRIVEN VESSEL (AHEAD/ALONGSIDE)
13	RESERVED FOR FUTURE USE
14	SART ACTIVE
15	UNDEFINED

7. Select [3 ETA].
8. Spin the scrollwheel to set the estimated day of the month to arrive, then left-click.
 Currently selected digit is highlighted by the cursor. 
 Spin the scrollwheel to adjust the day.
 Left-click to move to the next digit.
9. Select [4 DESTINATION], then left-click. The software keyboard appears.
10. Use the trackball to highlight a letter or digit on the software keyboard, then left-click. Repeat until the destination name is entered. (Max. 20 characters)
11. Use the trackball to highlight [END] on the software keyboard, then left-click.
12. Spin the scrollwheel to assign a destination number (1 to 10) to the destination entered at step 9, then left-click. The next time you use this place as your destination, simply select the corresponding destination number.
13. Select [5 DRAUGHT].
14. Spin the scrollwheel to set the ship's draught (0.0 to 25.5 m), then left-click.
15. Select [6 PERSONS].
16. Spin the scrollwheel to set the number of people on-board (0000 to 8191), then left-click.
17. Close the menu.

4.8 How to Display AIS Target Data

You can display an AIS target's data by selecting it on the display, when the AIS function is set for [DISP FILT] or [DISP ALL].

4.8.1 AIS pop-up information

The AIS pop-up shows abbreviated AIS data (Vessel name, COG, SOG, CPA, TCPA and destination*) for the selected AIS target. Simply put the cursor on the AIS target to show the pop-up.

*: Destination appears for Class A targets only.



```
NAME XXXXXXXXXXXX
COG 199.0°T
SOG 15.0kn
CPA 3.663NM
TCPA -18:35
DEST XXXXXXXXXXXX
```

Pop-up AIS data

Note: When the received AIS sentence does not contain certain data, the appropriate section of the pop-up shows "missing".

The pop-up can be enabled or disabled with the following procedure.

1. Open the menu.
2. Select [5 TT•AIS].
3. **For IMO-types**, select [4 TT•AIS SYMBOL].
For C-types, select [3 TT•AIS SYMBOL].
4. **For C-types**, select [0 NEXT].
For IMO-types, go to the next step.
5. Select [8 AIS POP UP INFO].
6. Select [ON] or [OFF] as appropriate.
7. Close the menu.

4.8.2 How to display basic AIS target data

Place the cursor on a desired AIS target and press the **TGT ACQ** key, or left-click. The target is highlighted with a square box and the selected AIS target's data is shown in AIS target data box inside the information box, on the right side of the screen. Unavailable data appears with the indication "missing".

Note 1: This feature requires [2 TGT DATA/ACQ SETTING], on the second page of the [CURSOR] menu, to be set as [ANY] or [AIS ONLY].

Note 2: A total of three AIS targets' data can be shown inside the information box. To change the information box settings, see section 1.48.

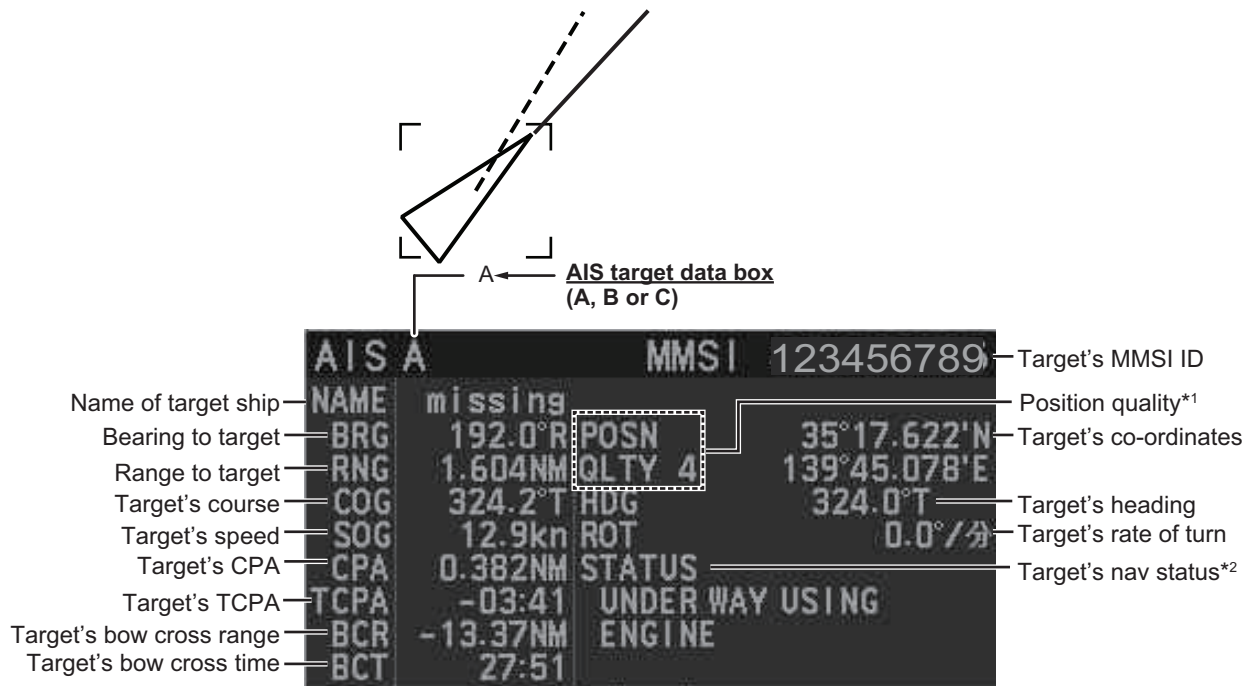

*1: Position quality indicates overall accuracy, and is calculated and displayed as shown below.

POSN QLTY value	Position accuracy
1	Position > 10 m
2	Position with RAIM > 10 m
3	Position ≤ 10 m
4	Position with RAIM ≤ 10 m

*2: For Class B targets, "CLASS B" appears in place of nav status.

4.8.3 How to display expanded AIS target data

The expanded AIS data display provides additional information about an AIS target, including call sign, IMO No., etc. To display expanded AIS data, show the basic data for a target, then left-click the target data display. The expanded data appears.

EXPANDED DATA	
Vessel name	NAME 12345678901234567890
Call sign	CALLSIGN 1234567
Position	LAT 35°22.604'N
	LOA 139°42.153'E
Type of position sensor	POSN SENSOR GPS GLONASS
Position accuracy	POSN ACC HIGH
Navigation status	STATUS POWER-DRIVEN VESSEL (AHEAD/ALONGSIDE)
MMSI number	MMSI No. 123456789
IMO number	IMO No. 123456789
Vessel dimensions	SHIP LENGTH 72m
	SHIP WIDTH 11m
	SHIP DRAUGHT 25.4m
Destination	DESTINATION 12345678901234567890
ETA at destination	ETA 23:59 31/DEC
AIS transponder version	AIS VERSION 1
Association (ON or OFF)	ASSOCIATION OFF
Ship and cargo type	SHIP AND CARGO TYPE CARGO SHIPS ALL SHIPS OF THIS TYPE
Repeat indicator	REPEAT INDICATOR 1

Note: Navigation status is not available for Class B targets. Where the selected AIS target is an aircraft, the [STATUS] box shows the aircraft's altitude.

If data for an item is unknown, "missing" appears.

4.8.4 How to remove target data from the display area

Place the cursor on a desired tracked target and press the **TARGET CANCEL** key. The select target's data is no longer displayed in the data display area.

4.9 How to Change AIS Symbol Attributes

To change the brilliance, size and color of AIS symbols follow the appropriate procedure in this section.

4.9.1 How to adjust the AIS symbol brilliance

Note: The brilliance of the AIS symbols can be adjusted from the [PLT] button on the Instant Access bar™. See section 1.46.1.

1. Open the menu.
2. Select [9 INITIAL SETTINGS].
3. Select [2 BRILL]. The [BRILL] menu appears.
4. Select [0 NEXT] to show the next menu page.
5. Select [8 AIS SYMBOLS]. The settings are highlighted and can now be adjusted.

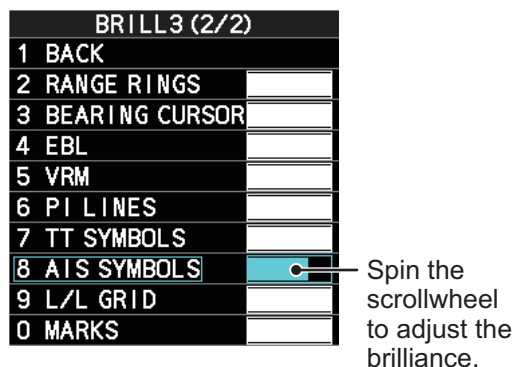

6. Spin the scrollwheel to select the desired brilliance, then left-click to apply the setting.
7. Close the menu.

4.9.2 How to change the color of the AIS symbol

1. Open the menu.
2. Select [5 TT•AIS].
3. **For IMO-types**, select [4 TT•AIS SYMBOL].
For C-types, select [3 TT•AIS SYMBOL].
4. **For IMO-types**, select [2 TT•AIS SYMBOL COLOR].
For C-types, select [4 AIS SYMBOL COLOR].
(For IMO-types, the color is shared between AIS and TT.)
5. Select the appropriate color, then left-click.
6. Close the menu.

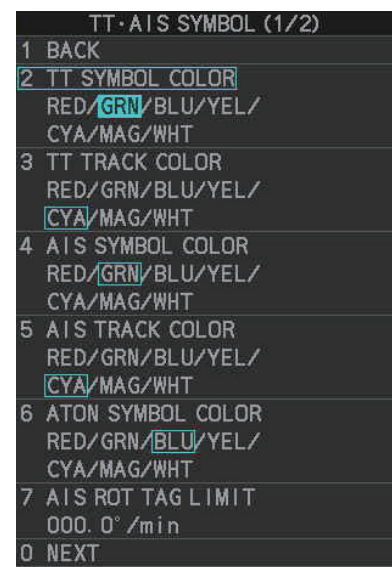

4.9.3 How to change the color of the ATON symbol

1. Open the menu.
2. Select [5 TT•AIS].
3. **For IMO-types**, select [4 TT•AIS SYMBOL].
For C-types, select [3 TT•AIS SYMBOL].
4. **For IMO-types**, select [3 ATON SYMBOL COLOR].
For C-types, select [6 ATON SYMBOL COLOR].
5. Select the appropriate color, then left-click.
6. Close the menu.

4.9.4 How to change the size of the AIS symbol

1. Open the menu.
2. Select [5 TT•AIS].
3. **For IMO-types**, select [4 TT•AIS SYMBOL].
For C-types, select [3 TT•AIS SYMBOL], then select [0 NEXT].
4. **For IMO-types**, select [6 AIS SCALED SYMBOL].
For C-types, select [4 AIS SCALED SYMBOL].
5. Select [OFF] or [ON] as appropriate, then left-click.
[OFF]: All AIS symbols are displayed in the same size.
[ON]: AIS symbols are displayed in scale, according to the ship length.

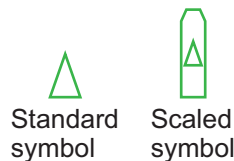

The figure above shows examples of standard and scaled symbols.

6. Close the menu.

4.9.5 How to customize the AIS symbol display (C-types only)

You can customize how the ship name, symbol color and trail color are displayed for up to 100 AIS targets.

1. Open the menu.
2. Select [5 TT•AIS].
3. Select [4 AIS].
4. Select [0 NEXT].
5. Select [4 CUSTOMIZE AIS DISPLAY].
6. Select [2 MMSI NO.].
7. Enter the MMSI of the vessel whose AIS display you want to customize.
If name data is available for the entered MMSI, the vessel name appears below the MMSI. If no name is available, the indication "missing" appears.

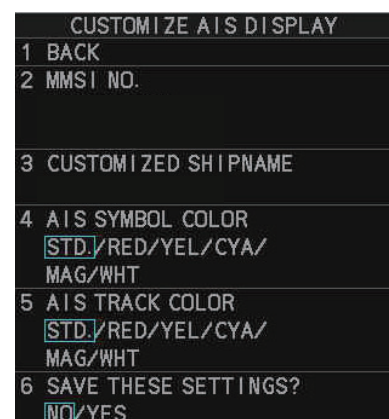

Note: You can also right-click an AIS target to open the [CUSTOMIZE AIS DISPLAY] menu with the selected vessel's MMSI field completed.

8. Select [3 CUSTOMIZE SHIP NAME].
9. Referring to section 1.5.3, enter a custom name for the vessel.
If [6 DISP CUSTOMIZED NAME] is set to [ON], the name set here appears near the AIS symbol. If [DISP CUSTOMIZED NAME] is set to [OFF] and the vessel is transmitting its name in the AIS data, the received name appears near the AIS symbol.
10. Select [4 AIS SYMBOL COLOR].
11. Select the color you want to show the selected AIS target's symbol with.
Select [STD.] to keep the color selected at section 4.9.2.
12. Select [5 AIS TRACK COLOR].
13. Select the color you want to show the selected AIS target's track with.
Select [STD.] to keep the color selected at section 4.9.2.
14. Select [6 SAVE THESE SETTINGS?].
15. Select [YES] to assign the customization to the selected AIS target.
Select [NO] to go back and change the customization.
16. Close the menu.

4.9.6 How to edit or remove AIS customizations (C-types only)

1. Open the menu.
2. Select [5 TT•AIS].
3. Select [4 AIS].
4. Select [0 NEXT].
5. Select [5 CUSTOM AIS LIST].

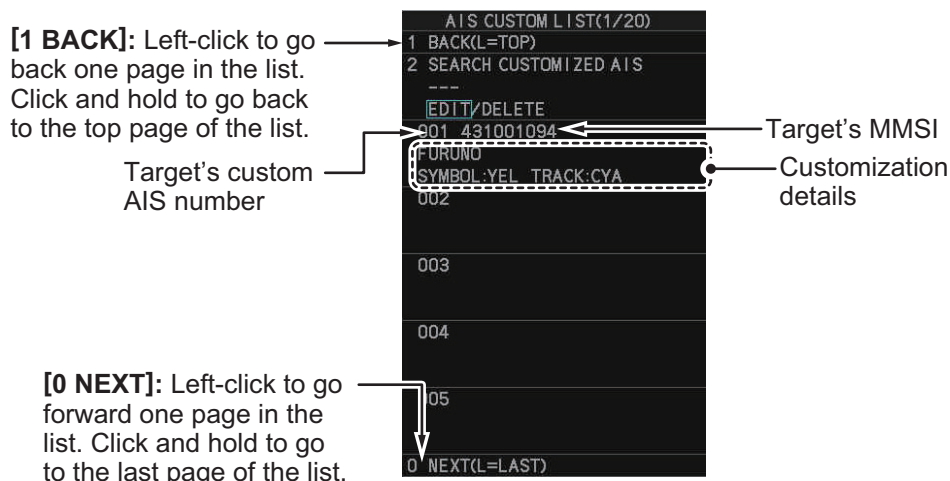

6. Select [2 SEARCH CUSTOMIZED AIS].
7. Enter the custom AIS number for the target whose details you want to edit.
8. **To change the customizations** for the selected AIS target, select [EDIT].
To remove all customizations for the selected AIS target, select [DELETE].
The [CUSTOMIZE AIS DISPLAY] menu appears.
9. Referring to section 4.9.5, change the customization settings as required.
10. Close the menu.

4.9.7 How to show/hide the customized AIS name (C-types only)

You can display a vessel's name below the corresponding AIS symbol.

1. Open the menu.
2. Select [5 TT•AIS].
3. Select [4 AIS].
4. Select [0 NEXT].
5. Select [6 DISP CUSTOMIZED NAME].
6. **To show the name**, select [ON]. The name set at section 4.9.5 appears below the icon for the selected vessel.
To hide the name, select [OFF]. Although the customized name is hidden, if the selected vessel is transmitting the vessel name in the AIS data, the vessel name received in the AIS data appears below the icon. If the AIS data does not contain the vessel's name, the class (A/B/C) appears instead.
7. Close the menu.

4.10 Past Position Display

The past position display shows equally time-spaced dots marking past positions of activated AIS targets. A new dot is added at preset time intervals until the preset number is reached. If a target changes its speed, the spacing will be uneven. If it changes course, its plotted course will not be a straight line.

Below are examples of past position displays.

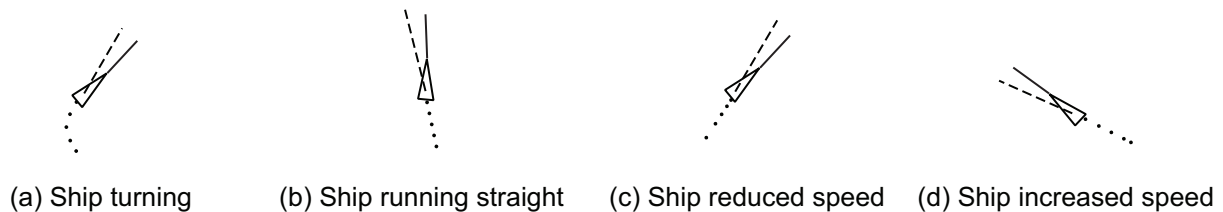

4.10.1 How to display past position points and select the plotting interval

Select the [PAST POSN] setting, then left-click to cycle through the following settings. [OFF] → [30sec] → [1min] → [2min] → [3min] → [6min] → [OFF]...



The past positions are displayed in accordance with the selected setting.

Note: The [PAST POSN] setting is hidden when [SIMPLE] display mode is used. To change the setting in [SIMPLE] mode, first restore [NORMAL] display mode, adjust the setting, then return to [SIMPLE] mode. See section 1.9 for how to change the display mode.

4.10.2 How to select the number of past position points to be displayed

1. Open the menu.
2. Select [5 TT•AIS].
3. **For IMO-types**, select [4 TT•AIS SYMBOL].
For C-types, select [3 TT•AIS SYMBOL], then select [0 NEXT].
4. **For IMO-types**, select [5 TT•AIS PAST POSN POINTS].
For C-types, select [3 TT•AIS PAST POSN PTS]
5. Select [5] or [10] as appropriate.
6. Close the menu.

4.10.3 Past position display orientation

Past position orientation, true or relative, is controlled with [TRAIL MODE] in the [TRAIL] context menu. To adjust the trail orientation, see section 1.37.1.

4.10.4 Stabilization in true motion

True motion past position display can be ground stabilized or sea stabilized. The [TRAIL] box shows current stabilization as "TRUE-G" or "TRUE-S". To change stabilization mode, open the [SHIP SPEED MENU] menu and set [SHIP SPEED] to [LOG(BT)] (ground stabilization) or [LOG(WT)] (sea stabilization).

4.10.5 How to set the AIS track color (C-types only)

You can set the AIS track color with the following procedure.

1. Open the menu.
2. Select [5 TT•AIS].
3. Select [3 TT•AIS SYMBOL].
4. Select [4 AIS TRACK COLOR].
5. Select the appropriate color, then left-click.
6. Close the menu.

4.11 Lost Target

A target is declared a lost target when it fails to produce data for six minutes or five reporting intervals, whichever is the shorter. When this occurs, the target is marked with the (flashing) lost target symbol and the message "AIS TARGET LOST" appears in the Alert Box. To acknowledge a lost target, press the **ALARM ACK** key, or use the trackball to select the [ALERT] box then press the **left button**.

4.11.1 How to set the lost target filter

If there are a lot of AIS targets in your area, the lost target alert can sound frequently. In this case you may wish to have the alert ignore lost targets whose range, speed, class or length are below the threshold value you specify.

1. Open the menu.
2. Select [5 TT•AIS].
3. **For IMO-types**, select [5 AIS].
For C-types, select [4 AIS].
4. Select [0 NEXT].
5. Select [3 AIS LOST TGT FILTER].
6. Select [MAX RANGE].
7. Referring to the following table, select the appropriate filter, then press the **ENTER MARK** key.

AIS LOST TGT FILTER	
1	BACK
2	MAX RANGE OFF/ON 12NM
3	MIN SHIP SPEED OFF/ON 1. 0kn
4	EXCEPT CLASS B OFF/ON

Filter type	Definition
[MAX RANGE]	Any AIS targets beyond the range set here will not trigger the lost target alert.
[MIN SHIP SPEED]	Any AIS targets slower than this setting will not trigger the lost target alert.
[EXCEPT CLASS B]	Select ON to prevent AIS targets class B triggering the lost target alert.

8. Select [ON], then press the **ENTER MARK** key. The settings can now be adjusted.
9. Spin the scrollwheel to adjust the setting as required, then left-click to apply the setting.
10. Close the menu.

4.11.2 How to enable/disable the lost target alert

The [LOST TARGET] box, located at the bottom-right corner of the screen, enables and disables the lost target alert.

Select the box with the cursor, then left-click to cycle through the settings in the following order: [OFF] → [FILT] → [ALL] → [OFF]...

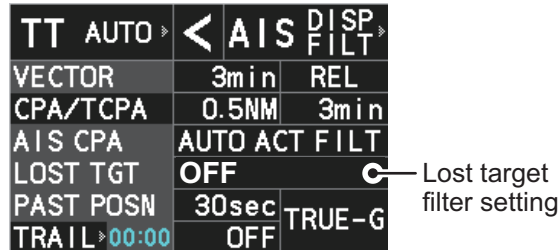

- [OFF]: Disable the alert.
- [FILT]: Enable the alert for all lost targets, excluding filtered targets.
- [ALL]: Enable the alert for all lost targets, including filtered targets.

Note: The lost target filter setting is hidden when [SIMPLE] display mode is used. To change TT settings in [SIMPLE] mode, first restore [NORMAL] display mode, adjust the settings, then return to [SIMPLE] mode. See section 1.9 for how to change the display mode.

4.12 ROT Setting

You can set the lower limit of the ROT (Rate Of Turn) at which the heading line on target symbols will point in direction which the vessel is turning.

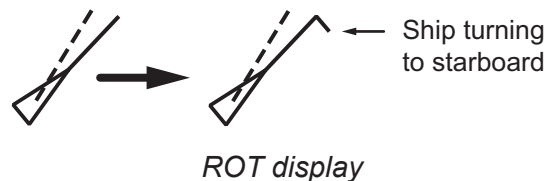

1. Open the menu.
2. Select [5 TT•AIS].
3. **For IMO-types**, select [4 TT•AIS SYMBOL].
For C-types, select [3 TT•AIS SYMBOL].
4. **For IMO-types**, select [4 AIS ROT TAG LIMIT].
For C-types, select [7 AIS ROT TAG LIMIT].
5. Spin the scrollwheel to adjust the ROT as appropriate, then left-click. The setting range is 000.0°/min to 720.0°/min.
6. Close the menu.

4.13 AIS Collision Alarm (CPA, TCPA)

This radar calculates CPA and TCPA by using own ship and relative target positions. An AIS dangerous target is one whose CPA and TCPA are within the range of the CPA and TCPA limits set in the TT/AIS box. The AIS symbol of an AIS dangerous target is red and flashing, and is announced with the Alert "AIS DANGER OF COLLISION". After the alert is acknowledged the target symbol is displayed in red color.

Dangerous target

When a sleeping or an activated target violates the CPA/TCPA alarm setting its symbol changes to the dangerous target symbol (red and flashing) and the message "AIS DANGER OF COLLISION" appears. To acknowledge the CPA/TCPA alarm, press the **ALARM ACK** key, click the [ALERT] box, or click the CPA/TCPA alarm in the ALERT LIST. The audible alarm is silenced and the symbol stops flashing. Take appropriate action to avoid collision.

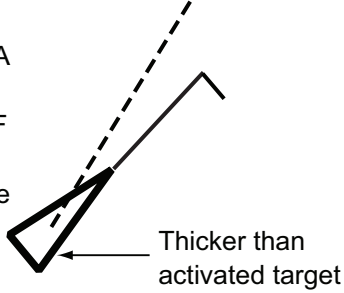

4.13.1 How to set CPA and TCPA

The CPA/TCPA function can be activated and deactivated from the [CPA/TCPA] box at the bottom-right of the screen.

1. Left-click the [CPA/TCPA] indication to activate the feature. Click the indication to toggle between active (settings are visible and can be changed) and inactive (indication shows "OFF").

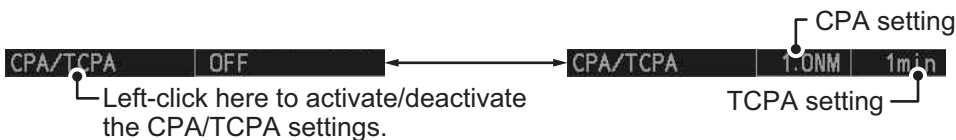

Note: The [CPA/TCPA] indication is hidden when [SIMPLE] display mode is used. To change the setting in [SIMPLE] mode, first restore [NORMAL] display mode, adjust the setting, then return to [SIMPLE] mode. See section 1.9 for how to change the display mode.

2. Place the cursor on the indication you wish to adjust.
3. Left-click, or spin the scrollwheel, to adjust the settings as required. The settings options are outlined in the table below.

Indication	Method	Settings options
CPA	Left-click	0.5, 1, 1.5, 2, 3, 4, 5, 6 (NM)
	Scrollwheel	0.1 to 20; 0 to 10 in 0.1 NM increments, 1 NM increments thereafter
TCPA	Left-click	1, 2, 3, 4, 5, 6, 12, 15 (minutes)
	Scrollwheel	1 to 60 minutes in 1-minute increments

4.14 How to Associate TT and AIS Targets

An AIS-equipped ship is usually displayed by two symbols on the radar display. This is because the AIS ship position is measured by a GPS navigator (L/L) whereas the radar detects the same ship by PPI principle (range and bearing relative to own ship radar antenna).

To avoid the presentation of two target symbols for the same physical target, use the "association" function. If target data from both AIS and TT are available and if the association criteria are fulfilled, either the AIS or TT symbol is presented according to the association method selected.

Association will not happen between AIS and TT if the AIS target is sleeping or the AIS target is lost.

1. Confirm that the [TT ACQ MODE] indication shows "AUTO", "AUTO MAN" or "MAN".

TT ACQ MODE indication 

2. Open the menu.
3. Select [5 TT•AIS].
4. **For IMO-types**, select [7 TARGET ASSOCIATION].
For C-types, select [6 TARGET ASSOCIATION].
5. Select [2 ASSOCIATION TGT TYPE].
6. Select [OFF], [AIS] or [TT], as appropriate, to select which symbols and data to display when the association criteria are met.

[OFF] : Disable association.

[AIS] : Use AIS symbols and AIS data.

[TT] : Use TT symbols and TT data.

TARGET ASSOCIATION	
1	BACK
2	ASSOCIATION TGT TYPE OFF/AIS/TT
3	GAP 0. 050NM
4	RANGE 0. 100NM
5	BEARING 9. 9°
6	SPEED 6. 0kn
7	COURSE 25. 0°

Note: In NORMAL display mode, association can also be switched on and off from the screen by left-clicking the Association Usage icon, shown below.



Left-click the association icon to change the association setting.

>: Use TT Symbols and data.

<: Use AIS symbols and data.

No indication: Association is disabled.

7. Referring to the table below, set the association criteria. Spin the scrollwheel to adjust the value, then left-click to confirm the setting.

[3 GAP] : Range between AIS target and tracked target.
(setting range: 0.000-0.050 (nm))

[4 RANGE] : Range direction difference from own ship to AIS target and tracked target. (setting range: 0.000-0.100 (nm))

[5 BEARING] : Bearing difference from own ship to AIS target and tracked target.
(setting range: 0.0-9.9 (°))

[6 SPEED] : Speed difference between AIS target and tracked target.
(setting range: 0.0-6.0 (kn))

[7 COURSE] : Course difference between AIS target and tracked target.
(setting range: 0.0-25.0 (°))

8. Close the menu.

4. AIS OPERATION

When the association criteria (gap, range, bearing, speed, and course) is met, and the ASSOCIATION TARGET setting is [AIS], the TT symbol is erased and only the AIS symbol is displayed.

All default association settings are restored whenever the power is turned on.

To show the association information, place the cursor on the target data box at the right side of the screen, then press the **ACQ** key. The selected target's AIS and TT data are displayed together as shown in the examples below.

TT/AIS DATA	
	TT AIS
	001 A
Bearing	BRG 085.1°R 085.1°R
Range	RNG 2.377NM 2.377NM
Course Over Ground	COG 085.1°R 085.1°R
Speed Over Ground	SOG 34.0kn 34.0kn
Closest Point of Approach	CPA 2.377NM 2.377NM
Time to Closest Point of Approach	TCPA 00:00 00:00
Bow Crossing Range	BCR 2.377NM 2.377NM
Bow Crossing Time	BCT 00:00 00:00
AIS	
Target's name	NAME 12345678901234567890
Target's MMSI	MMSI No. 123456789
Target's coordinates (latitude, longitude)	LAT 12°34.567'N LON 123°45.678'E
Target's heading	HDG 359.9°
Target's Rate Of Turn	ROT +359.9°/min
Target's navigational status*	STATUS POWER-DRIVEN VESSEL (AHEAD/ALONGSIDE)

*: Not shown for Class B targets.

4.15 How to View Own Ship Data

Own ship's static data (type of ship, call sign, etc.) can be viewed as follows:

1. Open the menu.
2. Select [5 TT•AIS].
3. **For IMO-types**, select [5 AIS].
For C-types, select [4 AIS].
4. Select [7 OWN SHIP DATA]. The [OWN SHIP DATA] menu appears.

OWN SHIP DATA	
1 BACK	
Name of your ship	NAME FURUNOMARU
Ship's callsign	CALLSIGN AZ1234567
Current location	LAT 35°15.004'N
	LON 139°46.360'E
Course/Speed	COG 180.0°T
	SOG 12.9kn
Heading/Rate of Turn	HDG 180.0°T
	ROT 0.0°/min
Positioning source and quality of positioning data	POSN SENSOR INTERNAL GNSS
	POSN QLTY 4
Ship's MMSI number	MMSI No. 431008509
Ship's IMO number	IMO No. 009791119
Ship's dimensions	SHIP LENGTH 149m
	SHIP WIDTH 24m
	SHIP DRAUGHT 6.8m
External EPFS device's installation location	EXT EPFS ANT POSN A: 028 B: 121m
	C: 06 D: 18m
AIS transponder version	AIS VERSION 1
Ship and cargo type	SHIP AND CARGO TYPE
	CARGO SHIPS
	ALL SHIPS OF THIS TYPE

Note: The indications "A", "B", "C" and "D" at [EXT EPFS ANT POSN] show the location of the external EPFS antenna, calculated in the following manner:

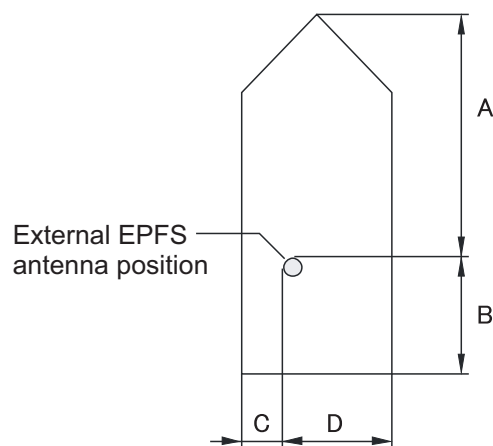

5. Close the menu.

4.16 How to Use AIS Messages

You can transmit and receive messages via the AIS, to a specified destination (MMSI) or all ships in the area. Messages can be sent to warn of safety of navigation, for example, an iceberg sighted. Routine messages are also permitted.

Short safety related messages are only an additional means to broadcast safety information. They do not remove the requirements of the GMDSS.

4.16.1 How to create and save messages

Up to ten messages can be saved at any time. To create and save a message, do the following:

Note: The MMSI of the receiving ship can be automatically set by selecting [TRANSMIT MESSAGE] from the pop up menu. To show the pop up menu, select the receiving ship's data in the AIS data display area, then press the **right button**.

1. Open the menu.
2. **For IMO-types**, select [5 AIS].
For C-types, select [4 AIS].
3. Select [5 AIS].
4. Select [5 TRANSMIT MESSAGE].

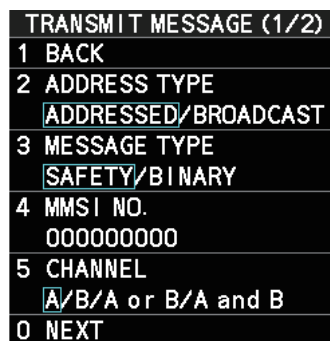

5. Select [2 ADDRESS TYPE].
6. Select [ADDRESSED] (message for a specific MMSI. Automatically selected if the MMSI is automatically using the data display.) or [BROADCAST] (message to all AIS-equipped vessels within the area), then press the **ENTER MARK** key.
7. Select [3 MESSAGE TYPE].
8. Select [SAFETY] (for safety messages) or [BINARY] (for routine messages), then press the **ENTER MARK** key.
9. For [ADDRESSED] message, do this step. For [BROADCAST] message, or if [TRANSMIT MESSAGE] was selected from the AIS data display pop up menu, go to step 8.
 - 1) Select [4 MMSI No.].
 - 2) Use the number keys to set the receiving ship's MMSI.
10. Select [5 CHANNEL].
11. Select the AIS channel to transmit your message over: [A], [B], [A or B], or [A and B], then press the **ENTER MARK** key.
12. Select [0 NEXT] to show the next menu page.
13. Select [4 EDIT]. A software keyboard appears at the bottom of the menu.

14. Select the character desired, then left-click.
The maximum of 80 characters can be entered for the message.

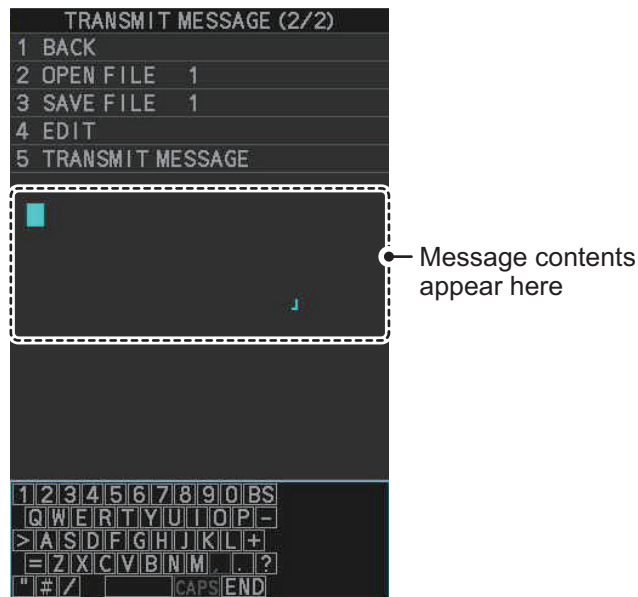

15. Select [END] to complete message input, then left-click.
16. Select [3 SAVE FILE].
17. Spin the scrollwheel to select the appropriate number, then left-click.
18. Close the menu.

4.16.2 How to transmit messages

1. Do one of the following:
 - a) Create a message, as described in subsection 4.16.1.
 - b) Use a file saved in the memory by selecting [5 TRANSMIT MESSAGE] followed by [2 OPEN FILE] from the second page of the [TRANSMIT MESSAGE] menu.
2. Select [5 TRANSMIT MESSAGE] from the second page of the [TRANSMIT MESSAGE] menu to transmit the message.
"TRANSMIT ERROR" appears in the alert box if an error occurred while transmitting the message.
3. Close the menu.

4.16.3 How to view messages

When an AIS message is received, the system automatically stores the message in the message list. If [AUTO DISP MESSAGE] in the [AIS TARGET MENU] is set to [ON], the envelope icon on the [AIS message] button, on lower half of the InstantAccess bar™, changes to a blue color to indicate a new, unread message is stored.

The system stores up to 200 AIS messages. When the storage capacity is reached the oldest AIS message is automatically erased to make room for the latest. Note that only received messages are backed up when the power is turned off. AIS alert messages are not backed up.

You can access the received messages from the InstantAccess bar™, or from the menu. The following procedure shows the menu method. **If you click the [AIS message] button on the lower half of the InstantAccess bar™, skip to step 5.**

1. Open the menu.
2. **For IMO-types**, select [5 AIS].
For C-types, select [4 AIS].
3. Select [5 AIS].
4. Select [4 SHOW RECEIVED MSGS].
5. Select the message to be displayed, then left-click.
6. The message details are displayed below the message list.
7. Close the menu.

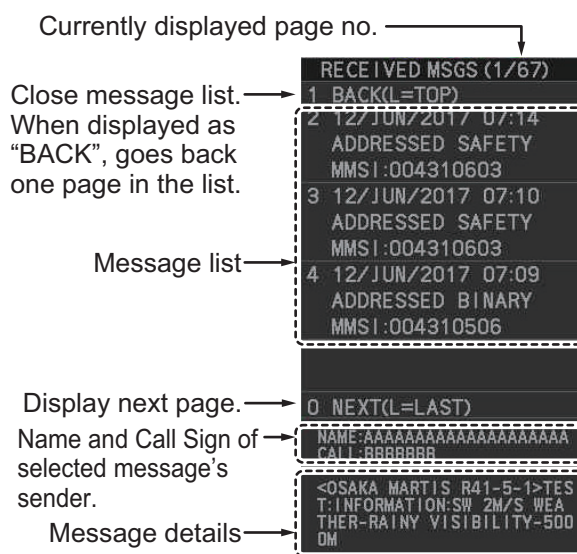

4.16.4 How to set up the AIS message notification

1. Open the menu.
2. Select [5 TT•AIS].
3. **For IMO-types**, select [5 AIS].
For C-types, select [4 AIS].
4. Select [3 AUTO DISP MESSAGE].
5. Select [ON] to show the received message indication (blue envelope icon) when a new message is received, [OFF] to disable the notification.

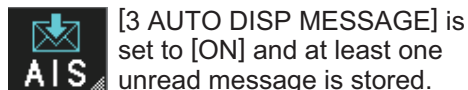
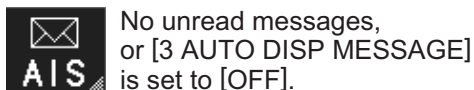

6. Close the menu.

4.16.5 How to display AIS alert messages

The AIS transponder outputs various alert messages. To view the alert list:

1. Open the menu.
2. Select [5 TT•AIS].
3. **For IMO-types**, select [5 AIS].
For C-types, select [4 AIS].
4. Select [8 AIS ALERT MESSAGES].
5. Select the date and time of the message to display, then left-click.

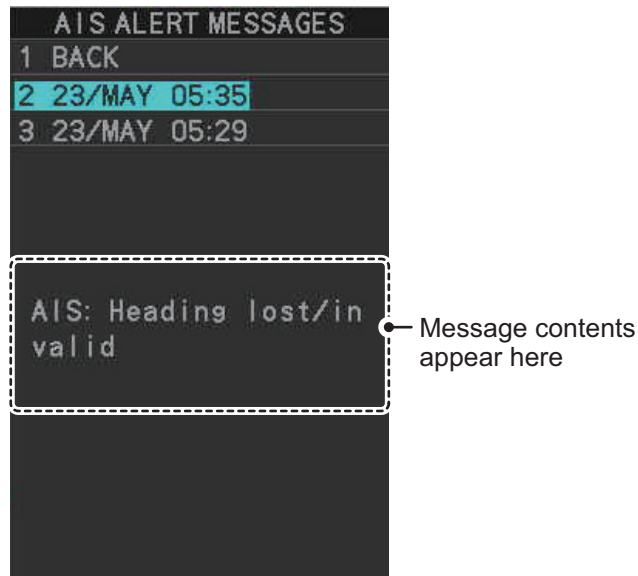

6. Close the menu.

4.17 AIS System Messages

AIS system messages are displayed at the bottom right corner of the screen. The table below shows the AIS system messages, their alert priority and their meanings.

Message	Priority	Meaning
"AIS DANGER OF COLLISION"	Alarm	CPA and TCPA of an activated AIS target are below value set on the menu.
"AIS NEW TARGET"	Warning	AIS target has entered an acquisition zone.
"AIS TARGET LOST"	Warning	Lost target. An activated target is declared a lost target when it fails to produce data for six minutes or five reporting intervals, whichever is the shorter.
"AIS DISPLAY FULL"	Warning	The radar only displays the closest 350 AIS targets from own ship.
"ACTIVE AIS FULL"	Warning	Number of active AIS targets has reached 50.
"AIS COM ERROR"	Warning	Not receiving AIS data from own AIS (VDO message). Note: When [AIS FUNC] is set to [OFF], this message is prioritized as a Caution level alert; when [AIS FUNC] is set to [ON], it is prioritized as a Warning level alert.
"AIS CAPACITY FULL"	Caution	Number of AIS targets has reached 1200.
"AIS DISPLAY 95%"	Caution	Number of displayed AIS targets has reached 333.
"ACTIVE AIS 95%"	Caution	Number of active AIS targets has reached 48.
"TRANSMIT ERROR"	Caution	Could not send AIS message.

4. AIS OPERATION

This page is intentionally left blank.

5. PLOTTER OPERATION (IMO-TYPES)

The video plotter has the following functions:

- Enter waypoints (up to 198) and marks.
- Creates and displays radar maps.
- Own ship track plotting.
- Display charts and chart-related information (requires a valid chart card).

5.1 Orientation Modes

Five orientation modes are available: [HEAD UP RM], [STAB HEAD UP RM], [COURSE UP RM], [NORTH UP RM], [NORTH UP TM] (True Motion).

Note: The screen may flash when the heading is changed more than one degree in the [HEAD UP RM] or [STAB HEAD UP RM] mode.

Automatic resetting of own ship mark in true motion mode

In the true motion mode, the own ship mark is automatically returned stern-ward 75% from the screen center when it reaches a location 50% of the display radius.

To select an orientation mode, see section 1.30.

5.2 How to Select a Mark Type

1. Open the menu.
2. Select [2 MARKS].
3. Select [5 RADAR MAP].
The [RADAR MAP] menu appears.
Note: You can also right-click the [MARK] box to open the [RADAR MAP] menu.
4. Select [3 MARK TYPE].
5. Select the appropriate type of marker, referring to the list below.
 - [ORIGIN MARK(No.)]: Inscribes the standard origin mark symbol (◊), with mark number (1 to 10). For detailed information regarding origin marks, see section 5.5.
 - [ORIGIN MARK(SYM)]: Inscribes an origin mark symbol, with no mark number. You can

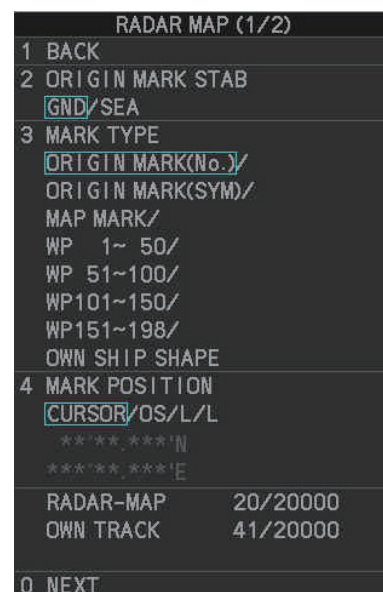

5. PLOTTER OPERATION (IMO-TYPES)

set one of the following symbols as the origin mark. See section 5.5 for details.



- [MAP MARK]: Inscribes the selected map mark.
 - [WP1-50], [WP51-100], [WP101-150], [WP151-198]: Inscribes a waypoint marker number within the selected range. For detailed information regarding waypoints, see section 5.9.
 - [OWN SHIP SHAPE]: Inscribes a mark with the same shape as own ship. For detailed information regarding the own ship mark, see section 5.6.
6. Close the menu.

5.3 How to Select the Mark Inscription Position

You can select the location at which the marker is inscribed from the following:

Location	Description
[CURSOR]	You can select the location using the Control Unit.
[OWN SHIP]	Marker is placed at own ship position.
[L/L]	Marker is placed at the co-ordinates selected.

1. Open the menu.
2. Select [2 MARKS].
3. Select [5 RADAR MAP].
The [RADAR MAP] menu appears.
Note: You can also right-click the [MARK] box to open the [RADAR MAP] menu.
4. Select [4 MARK POSITION].
5. Referring to the table above, select the appropriate location, then press the **ENTER MARK** key.

How to set the co-ordinates

Where [4 MARK POSITION] is set to [L/L], the co-ordinates settings are displayed. Co-ordinates can be set one digit at a time, as shown in the figure below.

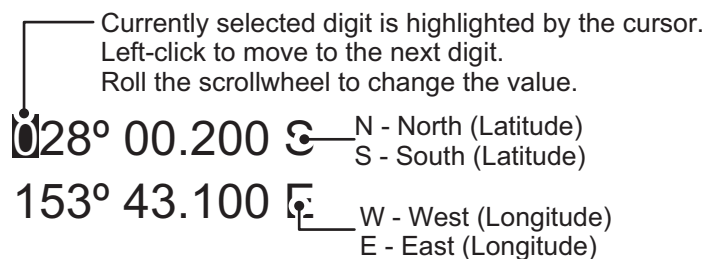

- 1) Spin the scrollwheel to change the value, then left-click to move to the next digit.
 - 2) Repeat step 1 to adjust the Latitude and Longitude as appropriate.
6. Close the menu.

5.4 Radar Map

A radar map is a combination of map lines and symbols whereby the user can define and input the navigation data, route planning and monitoring data. The radar map can contain 20,000 points of data. Inscribed marks are retained when the power is turned off.

The radar map is referenced to the WGS-84 datum and appears only when there is valid position data input. The radar map does not affect any radar functions.

Note: The location and orientation of mark symbols and mark lines can change, depending on the display presentation mode, as shown in the table below.

Presentation mode	Mark symbol	Mark line
HEAD UP RM/STERN UP RM/STAB HEAD UP RM	Location is changed according to heading and own ship position. Orientation is unchanged.	Location and orientation are changed according to heading and own ship position.
COURSE UP RM/NORTH UP RM/NORTH UP TM	Location is changed according to own ship position. Orientation is unchanged.	Location and orientation are changed according to own ship position.

5.4.1 How to show/hide the radar map

You can show or hide the radar map from the InstantAccess bar™. Click the [Radar Map] button to toggle between show and hide.

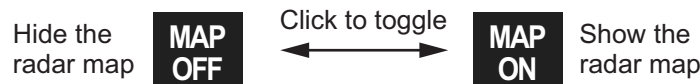

You can also show or hide the radar map from the menu. Open the [MAIN MENU] then select [2 MARKS] → [0 NEXT] → [2 RADAR MAP]. Select [OFF] or [ON] as appropriate.

5.4.2 How to inscribe marks

You can inscribe marks anywhere inside the operational display area, however, marks cannot be inscribed in the same location as a menu box.

Depending on the setting for [4 MARK POSITION] the method to inscribe a mark is slightly different.

Where [4 MARK POSITION] is set to [CURSOR]

1. Referring to section 5.2, select the mark type you want to use.
2. Place the cursor on the [MARK] box, at the bottom-left of the screen.
3. Spin the scrollwheel to select the appropriate mark, then left-click. The cursor moves inside the operational display area.
4. Place the cursor on the location (inside the operational display area) you wish to inscribe the mark, then left-click to anchor the mark.
5. Repeat steps 3 to 4 for multiple mark inscription.
6. Right-click to complete the procedure.

5. PLOTTER OPERATION (IMO-TYPES)

Where [4 MARK POSITION] is set to [OWN SHIP]

1. Referring to section 5.2, select the mark type you want to use.
2. Place the cursor on the [MARK] box, at the bottom-left of the screen.
3. Spin the scrollwheel to select the appropriate mark, then left-click. The selected mark is inscribed at the OS position.
4. Repeat steps 1 to 2 for multiple mark inscription, or right-click to complete the procedure.

Where [4 MARK POSITION] is set to [L/L]

1. Referring to section 5.2, select the mark type you want to use.
2. Place the cursor on the [MARK] box, at the bottom-left of the screen.
3. Spin the scrollwheel to select the appropriate mark, then left-click. [RADAR MAP] menu appears and the first digit of the latitude is selected.
4. Referring to section 5.3, set the latitude and longitude.
5. Repeat steps 1 to 3 for multiple mark inscription, or right-click to complete the procedure.

Note: You can see the number of radar map marks, lines used, on the [RADAR MAP] menu: [MENU]→[2 MARKS]→[5 RADAR MAP].



→ Radar map marks, lines entered/total number of marks, lines available

5.4.3 How to delete marks

Marks can be deleted one at a time, or all at once.

How to delete marks individually

1. Select the operational display area, then right-click to show the [CURSOR] context menu.
2. Select [MARK DELETE]. The cursor changes to a highlighted cursor.
3. Place the highlighted cursor on the mark to be deleted, then left-click.

Note: The position of the cursor determines how lines are deleted. To delete a line segment, put the cursor on the starting point (or end point). To delete consecutive line segments, put the cursor on the connecting point.

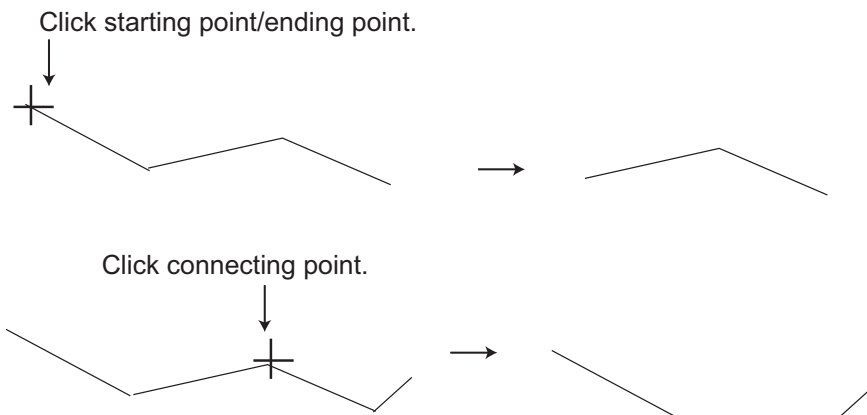

4. Repeat step 3 to delete another mark, or press the **right button** to return the cursor to normal function.

How to delete all marks

1. Open the menu.
2. Select [2 MARKS].
3. Select [8 DELETE DATA].

DELETE DATA	
1	BACK
2	ALL MARKS NO/YES
3	ALL WAYPOINTS NO/YES
4	ALL NAV LINES NO/YES
5	OS TRACK-COLOR/TIME RED/GRN/BLU/YEL/ CYA/MAG/WHT/30%/ 50%/80%/ALL

4. Select [2 ALL MARKS].
5. Select [YES], then press the **ENTER MARK** key.
6. Close the menu.

5.4.4 How to align the radar map

When there is positional error between the radar screen and radar map marks and lines, do the following to correct it.

1. Right-click the operational display area to show the [CURSOR MENU].
2. Select [MAP ALIGN]. The cursor is now highlighted and the [MAP ALIGN] function is active.
3. Left-click the map at the location you want to move. The map is now “anchored” to the cursor.
4. Move the cursor to align the radar map with the radar screen, then left-click. The indication "MAP ALIGN" appears on the right side of the operational display area.
5. Right-click to deactivate the [MAP ALIGN] function.

Display indications affected by map alignment

The following items are also re-aligned when the [MAP ALIGN] function is activated.

- Map marks
- Drop marks
- Anchor watch settings
- Target tracks
- AIS symbols
- EBL offsets (STAB GND mode only)
- Origin marks
- NAV lines and waypoints
- MOB marks
- Own ship tracks
- Latitude/Longitude Grid
- AIS symbol vector display
- Zoom window display (STAB GND mode only)
- Cursor position coordinates (when CURSOR L/L ALIGN is set to [ON] only)

Display indications unaffected by map alignment

The following items are not re-aligned when the [MAP ALIGN] function is activated.

- Radar echoes
- TT symbol vector display
- PI lines
- Own ship mark
- TT symbols
- EBL/VRM reference point
- OS coordinates ([POSN]) display
- Barge mark

How to disable the map alignment

1. Right-click the operational display area to show the [CURSOR MENU].
2. Select [MAP ALIGN], then left-click. The cursor is now highlighted and the [MAP ALIGN] function is active.
3. Press and hold the **left button**. The "MAP ALIGN" indication is cleared and the map alignment is cleared.
4. Right-click to deactivate the [MAP ALIGN] function.

5.5 Origin Mark

You can mark any prominent target or a point of particular interest using the origin mark feature. When an origin mark is entered, the distance and bearing from the cursor position to the mark are shown at the bottom of the screen, as in the figure below. Twenty origin marks may be entered.



5.5.1 How to inscribe origin marks

The method in which an origin mark is inscribed depends on the setting of [MARK POSITION] (section 5.3). Below are the procedures for each method.

Heading and position inputs are necessary to inscribe an origin mark.

Where [MARK POSITION] is set to [CURSOR]

1. Referring to section 5.2, set [3 MARK TYPE] to [ORIGIN MARK No.] or [ORIGIN MARK SYM].
2. Put the cursor on the [MARK] box at the bottom of the screen.
3. Spin the scrollwheel to select the origin mark to inscribe.
4. Click the [MARK] box.
5. Click the location where to put the origin mark.
The origin mark is inscribed at the location selected. To re-inscribe the origin mark at a different location, click the desired location for the mark.
6. To enter an origin mark at another location, spin the scrollwheel to change the origin mark, then click the desired location for the origin mark.
7. Right click to finish.

Where [MARK POSITION] is set to [OWN SHIP]

1. Referring to section 5.2, set [3 MARK TYPE] to [ORIGIN MARK No.] or [ORIGIN MARK SYM].
2. Put the cursor on the [MARK] box at the bottom of the screen.
3. Spin the scrollwheel to select the origin mark to inscribe.
4. Click the [MARK] box.
The origin mark is inscribed at own ship position.
5. Right click to finish.

5. PLOTTER OPERATION (IMO-TYPES)

Where [MARK POSITION] is set to [L/L POSITION]

1. Referring to section 5.2, set [3 MARK TYPE] to [ORIGIN MARK No.] or [ORIGIN MARK SYM].
2. Put the cursor on the [MARK] box at the bottom of the screen.
3. Spin the scrollwheel to select the origin mark to inscribe.
4. Click the [MARK] box.
The [RADAR MAP] menu appears with a window for entering latitude and longitude position.
5. Referring to section 5.3, enter latitude and longitude position of the origin mark.
After the position is entered, the origin mark appears at the position entered.
6. To continue inscribing origin marks in this method, do steps 2 to 5.

5.5.2 How to set origin mark stabilization

Origin marks can be geographically fixed (ground stabilized) or moving (sea stabilized).

1. Select the [MARK] box at the bottom-left of the screen then right-click to open the [RADAR MAP] context menu.
2. Select [2 ORIGIN MARK STAB].
3. Select [GND] or [SEA] as appropriate, then press the **ENTER MARK** key.
4. Close the menu.

5.5.3 How to delete origin marks

Origin marks can be erased as follows.

1. Right click anywhere within the radar effective inside diameter to show the [CURSOR MENU].
2. Select [MARK DELETE].
3. Click the origin mark to delete.
4. To delete another origin mark, repeat step 3.
5. Right click to finish.

5.6 How to Change the Shape of the Own Ship Mark

Ten locations on the own ship mark (section 1.44.5) can be adjusted to depict the shape of own ship more realistically. The ten points are as shown below.

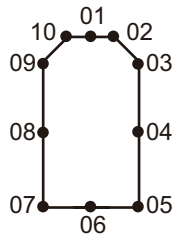

1. Referring to section 5.2, set [3 MARK TYPE] to [OWN SHIP SHAPE].
2. Put the cursor in the [MARK] box at the bottom of the screen.
3. Spin the scrollwheel to select the point no. to change.
The cursor moves to the selected point position.
4. Use the trackball to move the point to the position desired, then click.
Point position information appears in the [MARK] box, as shown in the figure below.

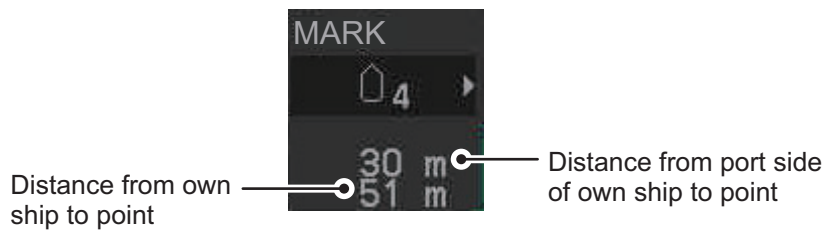

5. Repeat steps 3 to 4 to adjust other points.

5.7 How to Use ECDIS Chart Marks

Note: This function is only available if [ECDIS] is set to [SERIAL] or [LAN] at installation. Consult your dealer for details.

You can display marks received from an ECDIS on the radar screen. If the received mark also contains predicted position data, the predicted position is also displayed on-screen.

1. Open the menu.
2. Select [2 MARKS].
3. Select [6 ECDIS MARKS DISPLAY].
4. Select the appropriate item.
 - [2 USER CHART]: Shows/hides received user charts.
 - [3 CURVED EBL]: Shows/hides the received Curved EBL.
 - [4 CHART SYMBOL]: Shows/hides the received chart symbols.
 - [5 NOTE BOOK]: Shows/hides the received notes. [ON] shows notes only when they are received. [DISPLAY] shows notes continuously. The notes are shown in the information box at the right-side of the screen.
 - [6 ROUTE]: Shows/hides the received route. [CENT] shows only the route line; [ALL] shows both the route line and the route width.
 - [7 PREDICTOR]: Shows/hides the received predicted position with a symbol (dotted line) of the same size as the own ship.
5. Select [ON] or [OFF] as appropriate, then press the **ENTER MARK** key. [ON] shows the selected item's ECDIS mark when received, [OFF] hides the ECDIS mark.
6. Close the menu.

ECDIS MARKS DISPLAY	
1	BACK
2	USER CHART OFF/ON
3	CURVED EBL OFF/ON
4	CHART SYMBOL OFF/ON
5	NOTE BOOK OFF/ON/DISPLAY
6	ROUTE OFF/CENT/ALL
7	PREDICTOR OFF/ON

5.8 Own Ship Track

A total of 20,000 points are allotted for storage of own ship's track, marks and lines.

When this memory becomes full, the oldest track is deleted to make room for the latest. For that reason you may want to adjust the recording interval to conserve the memory.

Note: You can check how many tracks have been used at any time from the [RADAR MAP] menu. The number of points used and the total number available are shown at the bottom of the [RADAR MAP] menu's first page.

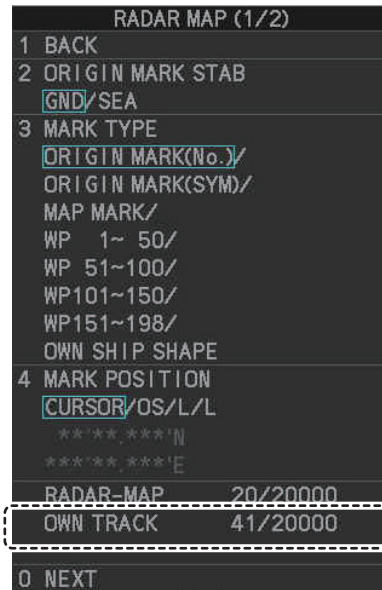

Own ship track points used/total number of own ship track points available

5.8.1 How to show/hide tracks

You can show or hide tracks for own ship.

1. Open the menu.
2. Select [2 MARKS].
3. Select [7 TRACKS].
4. Select [2 OWN TRACK].
5. Select [2 DISPLAY OWN TRACK].
6. Select [ON] to show tracks, or [OFF] to hide tracks.
7. Close the menu.

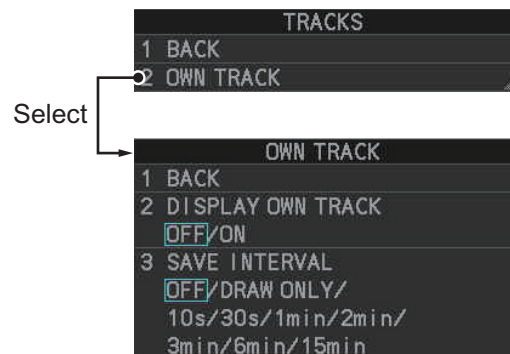

5.8.2 How to set the plotting interval

The system plots tracks at regular intervals in order to “paint” the track. You can adjust this interval. A shorter interval gives a “smoother” track, however the maximum recording time is reduced.

1. Open the menu.
2. Select [2 MARKS].
3. Select [7 TRACKS].
4. Select [2 OWN TRACK].
5. Select [3 SAVE INTERVAL].
6. Select the appropriate setting, then left-click.

The table below shows the relation between plotting interval settings and maximum track recording time.

Own track recording times

Interval	Max. Recording Time	Interval	Max. Recording Time
10 s	56 hours	3 min	1000 hours
30 s	167 hours	6 min	2000 hours
1 min	333 hours	15 min	5000 hours
2 min	667 hours	DRAW ONLY	No track data recorded.

Set the interval to [OFF] to hide tracks made from the time you make this setting. To hide both new and old tracks, set [2 DISPLAY OWN TRACK] to [OFF].

7. Close the menu.

5.8.3 How to delete tracks

Track can be deleted partially (based on length) or completely, as follows.

1. Open the menu.
2. Select [2 MARKS].
3. Select [8 DELETE DATA].
4. Select [5 OS TRACK-COLOR/TIME].
5. Select the percentage of the track you wish to delete, then left-click. The available options are: [30%], [50%], [80%] or [ALL].
6. Close the menu.

5.9 How to Use Waypoints

A particular location is known as a “waypoint”, whether it be a starting point, a destination point or an intermediate point on a voyage. This radar system can store 200 waypoints. Waypoints 1 to 198 are user set waypoints, waypoint 199 is reserved for external input, waypoint 200 is reserved for MOB (Man Over Board). Waypoints can be entered with the cursor, or from the menu (manual input of latitude and longitude). Waypoints 1 to 198 can be edited from the menu.

5.9.1 How to set the data source for waypoints

1. Open the menu.
2. Select [8 NAVLINE•WPT].
3. Select [2 NAV LINE DATA SOURCE].
4. Select the appropriate data source, referring to the list below.
 - [OFF]: Waypoints and nav lines (such as tracks) are not shown.
 - [EXT DATA]: Use navigational data from an external EPFS device for waypoints and nav lines (waypoint 199).
 - [INTERNAL DATA]: Use waypoints and nav lines saved internally (waypoints 1 to 198).
5. Close the menu.

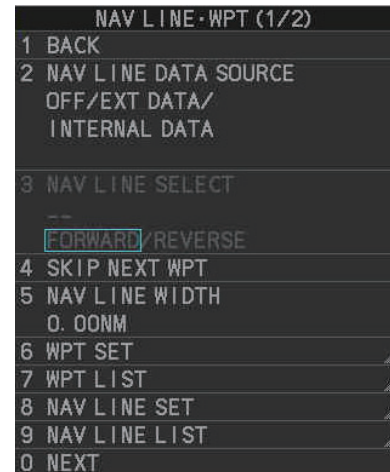

5.9.2 How to enter waypoints

A waypoint can be entered two ways: with the cursor or manual entry of latitude and longitude position. After a waypoint is entered, the distance and bearing from own ship to the waypoint are shown in the [MARK] box.



How to enter waypoints with the cursor

1. Referring to section 5.2, select the appropriate waypoint number group. The available groups are: [WP1 to WP50], [WP51 to WP100], [WP101 to WP150] or [WP151 to WP198].
2. Place the cursor on the [MARK] box. Spin the scrollwheel to select the waypoint number for new waypoint, then left-click. The cursor jumps inside the operational display area.
3. Place the cursor on the location to inscribe the waypoint, then left-click.
4. Repeat steps 2 to 3 to inscribe other waypoints.
5. Right-click the operational display area to complete waypoint inscription.

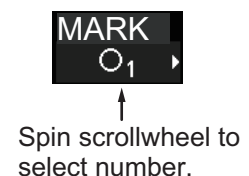

5. PLOTTER OPERATION (IMO-TYPES)

How to enter/edit waypoints from the menu

Note: A waypoint cannot be edited if it is part of an active route.

1. Open the menu.
2. Select [8 NAVLINE•WPT].
3. Select [2 WPT SET].

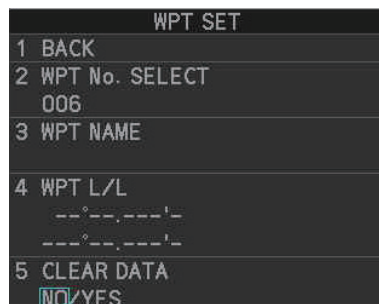

4. Select [2 WPT NO. SELECT].
5. Spin the scrollwheel, or use the control unit numbered keys, to select a waypoint number, then left-click.
To edit or input a waypoint name, go to step 6.
To skip naming the waypoint, go to step 7.
6. Select [3 WPT NAME], then left-click. The software keyboard appears. Referring to section 1.5.3, name the waypoint.
7. Select [4 WPT L/L]. The latitude and longitude settings can now be adjusted.
8. Input the latitude and longitude with the number keys, or spin the scrollwheel to select a digit, then left-click to move to the next digit.

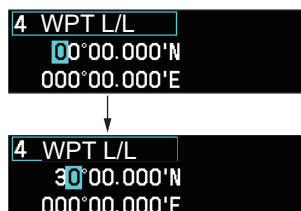

Use the scrollwheel to select a numeral, then left-click. The cursor jumps to the next right place. Repeat to enter the latitude and longitude.

9. Close the menu.

5.9.3 How to edit waypoints

Note: A waypoint cannot be edited if it is part of an active route.

1. Open the menu.
2. Select [8 NAVLINE•WPT].
3. Select [2 WPT SET].
4. Select [2 WPT NO. SELECT].
5. Select the waypoint number to edit.
6. Select the waypoint data to edit, then make necessary changes.
 - [WPT NAME]: Use the software keyboard to change the name.
 - [WPT L/L]: Spin the scrollwheel to change the latitude and longitude position of the waypoint.
7. Close the menu.

5.9.4 How to erase waypoints

There are two methods to erase individual waypoints: cursor selection or from the menu.

How to erase a waypoint by cursor selection

1. Place the cursor inside the operational display area, then right-click.
2. Select [MARK DELETE]. The mark delete function is activated and the cursor is highlighted when inside the operational display area.
3. Select the waypoint you wish to delete, then left-click.
4. Right-click inside the operational display area to deactivate the mark delete function.

How to erase a waypoint from the menu

1. Open the menu.
2. Select [8 NAVLINE•WPT].
3. Select [6 WPT SET].
4. Select [2 WPT NO. SELECT]. Then select the waypoint to erase.
5. Select [5 CLEAR DATA].
6. Select [YES] or [NO] as appropriate, then left-click.
7. Close the menu.

How to erase all waypoints

You can erase all waypoints from the menu. If there is an active route, this procedure cannot be completed.

1. Open the menu.
2. Select [2 MARKS].
3. Select [8 DELETE DATA].
4. Select [3 ALL WAYPOINTS].
5. Select [YES] to erase all waypoints. Select [NO] to cancel the procedure.
Note: All routes are also deleted with this procedure.
6. Close the menu.

5.9.5 How to display the waypoint list

1. Open the menu.
2. Select [8 NAVLINE•WPT].
3. Select [7 WPT LIST] to show the [WPT LIST].

- Click while on page No.1 to close the list.
- Click while on page No.2 or after to go back on page.
- Long-push the left button to go to page No.1.

Displayed page/Total no. of pages

WPT No., WPT name

Latitude and longitude position of waypoint

- Go to next page.
- Long-push the left button to go to last page.

4. Close the menu.

5.9.6 How to show/hide the waypoint name/number

1. Open the menu.
2. Select [8 NAVLINE•WPT], then select [0 NEXT] to show the next page.

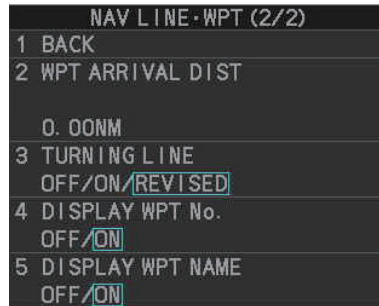

3. Select [4 DISP WPT NO.] or [5 DISP WPT NAME] as appropriate.
4. Select [ON] to show the waypoint name/number, or [NO] to hide the waypoint name/number, then left-click. The waypoint number and/or waypoint name appear to the right of the waypoint mark.

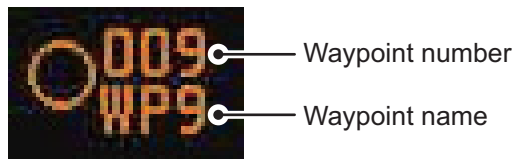

5. Close the menu.

5.10 Routes

You can display one route (NAV LINE), which is either received from a connected EPFS device (GPS, etc), or stored internally.

5.10.1 How to set/edit an internal route

You can store up to 30 routes, each with up to 30 waypoints, in the internal memory.

The procedure for new routes and route editing is the same. To edit a route, you can skip setting other items and only edit the items you wish to change.

Note: While a route is active, tracks and waypoints cannot be deleted and data cannot be loaded from an SD card.

1. Open the menu.
2. Select [8 NAVLINE•WPT].
3. Select [8 NAV LINE SET] to show the [NAV LINE SET] menu.
4. Select [2 SELECT NAV LINE].
5. Spin the scrollwheel, or input the number from the keyboard, to assign a number to the route. The input areas for [3 NAV LINE], [4 NAV LINE ENTRY] and [5 CLEAR DATA] become active.
6. Select [3 NAV LINE NAME].
7. Referring to section 1.5.3, assign a name to the route. You can use up to 15 characters in the name.
8. Select [4 NAV LINE ENTRY].
9. Spin the scrollwheel to select a waypoint, then left-click.
10. Repeat step 9 until all waypoints for the route are entered.

When the last waypoint is entered, move the cursor to the next blank input area, then left-click, or assign the last waypoint as "000" using the numeric keys. If 30 waypoints are entered, the setting process for waypoints is automatically completed.

11. Close the menu.

NAV LINE SET			
1	BACK		
2	SELECT NAV LINE 02		
3	NAV LINE NAME FURUMO TEST RUN		
4	NAV LINE ENTRY		
	001 -	002 -	003 -
	004 -	005 -	-
	-	-	-
	-	-	-
	-	-	-
	-	-	-
	-	-	-
	-	-	-
5	CLEAR DATA NO/YES		

5.10.2 How to display routes

To display internal routes or received routes, follow the procedure below.

1. Open the menu.
2. Select [8 NAV LINE•WPT]. The [8 NAV LINE•WPT] menu appears.
3. Select [2 NAV LINE DATA SOURCE].
4. Select the desired source, referring to the list below.
 - [OFF]: No routes are displayed.
 - [EXT DATA]: Routes received from external sources are displayed.
 - [INTERNAL DATA]: Routes saved in the internal memory are displayed.

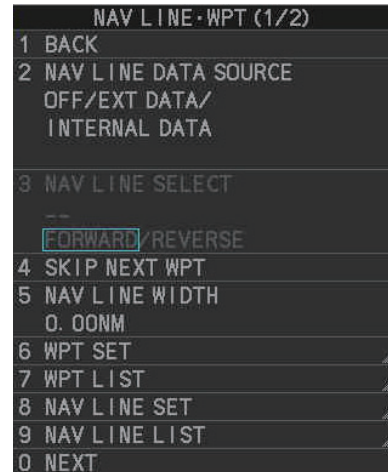

For [INTERNAL DATA], see step 5; for [EXT DATA], see step 8.

5. Select [NAV LINE SELECT].
6. Spin the scrollwheel to select the desired route number, then left-click.
7. Select the direction you want to navigate the route in.
 - [FORWARD]: Navigate the route in the direction in which it was created.
 - [REVERSE]: Navigate the route in reverse of the direction in which it was created.
8. Close the menu.

5.10.3 How to skip a waypoint

On a voyage similar to the below example, you may want to skip a waypoint to save time. You can skip the next waypoint on the current leg of your route by using the procedure below.

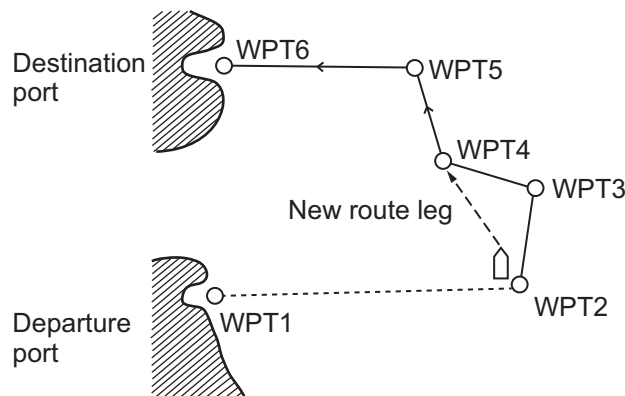

1. Open the menu.
2. Select [8 NAV LINE•WPT] to show the [8 NAV LINE•WPT] menu.
3. Select [4 SKIP NEXT WPT].
4. Close the menu.

5.10.4 How to set the route width

You can set a width for each route (NAV LINE). For example, if you set a 5 NM route width, the route width is 5 NM to port and starboard, with the own ship as the center. The route width is displayed as orange dotted lines to either side of the route line.

To set a route width, do the following:

1. Open the menu.
2. Select [8 NAVLINE•WPT].
3. Select [5 NAV LINE WIDTH].
4. Spin the scrollwheel, or use the numeric keys, to set a width for the route. To disable the route width alert and hide the route width lines, set the width to [0.00 NM].

Note: This width is applied to all routes.

5. Close the menu.

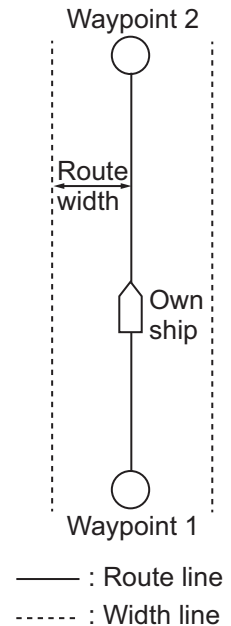

5.10.5 How to show/hide the turning line

You can show or hide the turning line, the point at which your vessel starts a turn in a route.

1. Open the menu.
2. Select [8 NAVLINE•WPT].
3. Select [0 NEXT].
4. Select [3 TURNING LINE].
5. Select the appropriate setting, referring to the list below.
 - [OFF]: Turning line is hidden.
 - [ON]: Turning line is displayed.
 - [REVISED]: Turning line is displayed, but offset based on the route and current own ship position.
6. Close the menu.

Estimated course with no offset calculation*

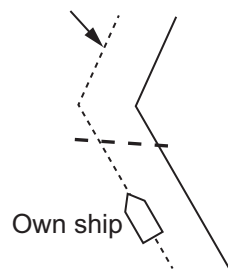

[TURNING LINE] set to [ON]

— : Route
 - - - - : Track
 - - - - : Turning line

Estimated course with offset calculation*

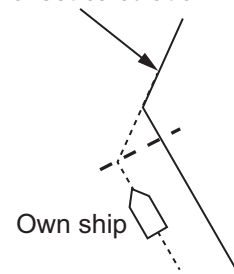

[TURNING LINE] set to [REVISED]

*: Estimated course is not displayed on-screen.

5.10.6 How to use the waypoint arrival distance function

The waypoint arrival distance function lets you know when you are within a preset distance from the next waypoint. When the waypoint arrival area is set, the next waypoint is shown circumscribed with a dashed orange-colored circle, whose radius is equivalent to waypoint arrival distance setting. When your vessel comes within the destination arrival radius, the system places the arrival radius marker on the next destination.

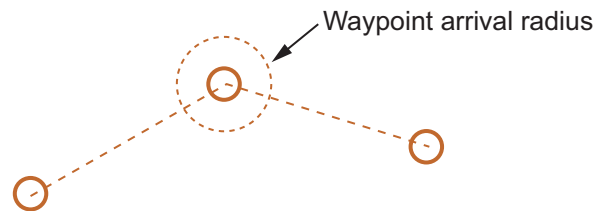

To set and use the waypoint arrival area function, follow the procedure below.

1. Open the menu.
2. Select [8 NAVLINE•WPT].
3. Select [0 NEXT] to show the second page of the [NAVLINE•WPT] menu appears.
4. Select [2 WPT ARRIVAL DIST].
5. Set the width (radius) of the arrival area.
6. Close the menu.

5.10.7 How to delete internal routes

You can delete a specified route, or all routes.

Note: Active routes and routes from external sources cannot be deleted.

How to delete individual internal routes

1. Open the menu.
2. Select [8 NAVLINE•WPT].
3. Select [8 NAVLINE SET].
4. Select [2 SELECT NAV LINE].
5. Spin the scrollwheel, or input the number from the keyboard, to select the route you want to delete.
6. Select [5 CLEAR DATA].
7. Select [YES] to delete the selected route.
8. Close the menu.

How to delete all internal routes

1. Open the menu.
2. Select [2 MARKS].
3. Select [8 DELETE DATA].
4. Select [4 ALL NAV LINES].
5. Select [YES] to delete all internal routes.
6. Close the menu.

5.10.8 How to view the routes list

Routes saved to the internal memory can be view by following the procedure below.

1. Open the menu.
2. Select [8 NAVLINE•WPT].
3. Select [9 NAVLINE LIST] to show the [NAVLINE LIST]

- Click while on page No.1 to close the list.
- Click while on page No.2 or after to go back on page.
- Long-push the left button to go to page No.1.

Displayed page/Total no. of pages

Route number/
route name*

Waypoints registered
to the route

- Go to next page.
- Long-push the left button
to go to last page.

* Route name is blank if no name is registered.

4. Close the menu.

5.11 How to Show/Hide Grid Lines

1. Open the menu.
2. Select [2 MARK].
3. Select [0 NEXT] to show the next page.
4. Select [2 GRID], then select [ON] to show the grid, or [OFF] to hide the grid.
5. Close the menu.

MARK (2/2)	
1	BACK
2	GRID
	OFF/ON

5. PLOTTER OPERATION (IMO-TYPES)

This page is intentionally left blank.

6. PLOTTER OPERATION (C-TYPES)

Plotter operation is available in both IMO- and C-type specifications, with the functions and menus different for each type. This chapter covers the operations for the C-type. For the IMO-type, see chapter 5.

The following plotter functions are available with the C-type radar:

- Display own ship track and other ship track.
- Enter waypoints.
- Enter marks.
- Create routes.
- Set destination.
- Display charts and chart-related information (requires a valid chart card).

6.1 Tracks

Own ship track is traced on the display based on position data sent from position-fixing equipment. Additionally, with connection of a AIS transponder or GPS buoy, other ships' tracks can also be shown.

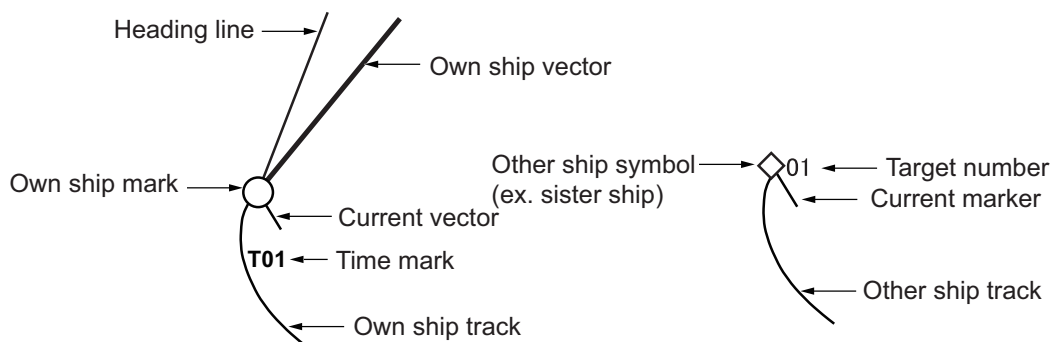

Own ship track and other ship track can be saved as a route. For details see "Creating a route from existing tracks" on page 6-53.

Note: Own ship track and other ship track are automatically saved every ten minutes and when the radar goes into standby (STBY) mode.

6.1.1 Symbols

Own ship mark

The own ship mark appears at current position. The mark changes as shown in the figure to the right, depending on whether you are plotting a track.

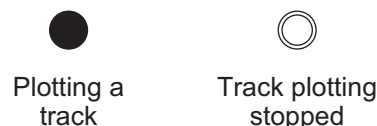

In addition to marking own ship position, the mark has the following functions:

- The **own ship vector** line (thick, white) points in the direction of ship's course.
- The **heading line**, colored light blue, points in the direction of ship's heading.
- The **current vector** points in the direction of the tide flow for a maximum of five depth layers. (Layer #1, yellow; layer #2, purple; layer #3, blue; layer #4, green, layer #5, white.). Requires tide data in NMEA 0183 format.

6. PLOTTER OPERATION (C-TYPES)

How to show/hide the own ship vector

Follow the procedure below to show or hide the own ship vector.

1. Open the menu.
2. Select [9 INITIAL SETTINGS].
3. Select [5 OPERATION].
4. Select [4 OWN SHIP VECTOR].
5. Select one of the following:
 - [OFF]: Hide the own ship vector.
 - [HDG]: The own ship vector points in heading direction.
 - [COURSE]: The own ship vector points in course direction.
6. Close the menu.

How to show/hide other ships' tracks

The following are required in order to show other ships' tracks.

- A AIS transponder or GPS buoy
- Own ship position data
- Set up on this radar
- See "SYMBOLS" on page AP-32 for TT and AIS symbols.

Do the following to show or hide the consort symbol, GPS buoy symbol.

1. Open the menu.
2. Select [5 TT•AIS].
3. Select [5 CONSORT•GPS BUOY].
4. Select [5 CONSORT DISPLAY] or [6 GPS BUOY DISPLAY].
5. Select [ON] or [OFF] as appropriate. The following symbols may appear when [ON] is selected.
 - : GPS buoy symbol
 - : Consort ship symbol
6. Close the menu.

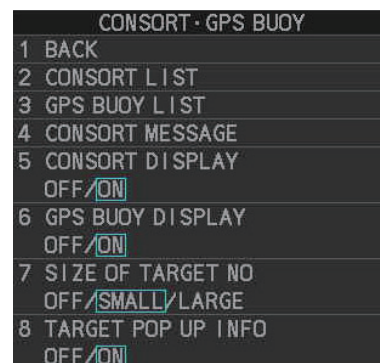

How to change the size of the target no. display for consort ship, GPS buoy

Do the following to change the size of the target no. display for consort ship, GPS buoy.

1. Open the menu.
2. Select [5 TT•AIS].
3. Select [5 CONSORT•GPS BUOY].
4. Select [7 SIZE OF TARGET NO].
5. Select [OFF] (hide target no. display), [SMALL] or [LARGE] as appropriate.
6. Close the menu.

6.1.2 How to show/hide ships' tracks

Show/hide own ship's tracks

Do the following to show or hide own ship's tracks.

1. Open the menu.
2. Select [2 MARKS•PLOTTER].
3. Select [3 TRACK].
4. Select [8 OWN TRACK SETTINGS].
5. Select [2 OWN TRACK DISPLAY].
6. Select [ON] or [OFF] as required. For [ON], the cursor moves to the [MAX. POINTS] indication.
7. You can set the max. number of track points to save. Spin the scrollwheel to set desired value.
8. Close the menu.

Note: Time can be marked hourly with the time mark (T). Set [7 TIME MARK DISPLAY] to [ON] to show the time mark. The time is updated every hour, on the hour and appears as two digits (T01, T02, etc.), in 24-hour format, regardless of the setting selected in the [DATE] menu.

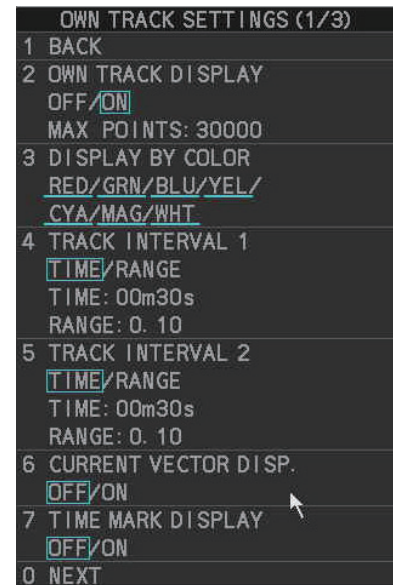

Show/hide other ships' tracks

Do the following to show or hide other ships' tracks.

1. Open the menu.
2. Select [2 MARKS•PLOTTER].
3. Select [3 TRACK].
4. Select [8 OTHER TRACK SETTINGS].
5. Select [2 AIS TRACK DISPLAY], [3 CONSORT TRACK DISPLAY], [4 TT TRACK DISPLAY], or [5 GPS BUOY TRACK DISPLAY].
6. Select [ON] or [OFF] as required.
7. Close the menu.



Show/hide current vector display on other ships' tracks

Do the following to show or hide the current vector display on other ships' tracks.

1. Open the menu.
2. Select [2 MARKS•PLOTTER].
3. Select [3 TRACK].
4. Select [8 OTHER TRACK SETTINGS].
5. Select [2 AIS TRACK DISPLAY], [3 CONSORT TRACK DISPLAY], [4 TT TRACK DISPLAY], or [5 GPS BUOY TRACK DISPLAY].

6. PLOTTER OPERATION (C-TYPES)

6. Select [ON] or [OFF] as required.
7. Select [1 BACK] to return to the [TRACK] menu.
8. Select [8 OTHER TRACK SETTINGS].
9. Select [7 OTHER CURR VCT DISP.].
10. Select [ON] or [OFF] as required. For [ON], go to the next step to set the current measuring layers to use.
11. Select [1 BACK] to return to the [TRACK] menu.
12. Select [0 NEXT].
13. Select [3 SET CURRENT LAYER].
14. Select [1LAYER]. Spin the scrollwheel to set the measuring layer (1 to 5) to use.
15. Do the same for [2LAYER], [3LAYER].
16. Close the menu.

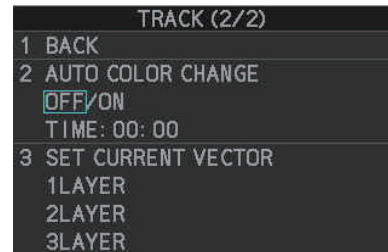

How to automatically display the tracks of acquired TT

You can automatically display the tracks of acquired TT as follows.

1. Open the menu.
2. Select [2 MARKS•PLOTTER].
3. Select [3 TRACK].
4. Select [9 OTHER TRACKS DISPLAY].
5. Select [4 TT TRACKS DISPLAY].
6. Select [ON] or [OFF] as required.
 - [ON]: Track of all TT is displayed.
 - [OFF]: Track of TT is not displayed. To show the track of a TT, do the following:
 - 1) Put the cursor within the radar effective radius, then right click to show the [CURSOR] menu.
 - 2) Select [TRACK ON-OFF].
 - 3) Click the TT whose track you want to show.
 - 4) Right-click to finish.
7. Close the menu.

6.1.3 How to set own ship track recording

How to start/stop recording own ship track

You can stop recording own ship track when the ship is anchored for an extended period or in port. This will help prevent unnecessary recording of track points.

1. Put the cursor within the radar effective radius, then right click.
2. Select [TRACK ON-OFF].
3. Right-click within the radar effective radius until the “Hold” icon (**H**) appears. Each click selects a track recording interval or stops recording in the following sequence.



When recording is stopped, the appearance of the own ship mark changes from filled circle (●) to a pair of concentric circles (○).

4. Right-click to finish.

To restart recording, repeat the above procedure to show the recording interval 1 icon (⊕1) or recording interval 2 icon (⊕2). The own ship mark changes from (○) to (●).

Note: For RCU-031 users, you can also press **TRACK ON/OFF** to toggle recording.

How to show/hide track without recorded them

1. Open the menu.
2. Select [2 MARKS•PLOTTER].
3. Select [3 TRACK].
4. Select [6 DISP. STOPPED TRACKS].
5. Select [ON] or [OFF] as required.

- [OFF]: Tracks made while recording is off are not shown.

- [ON]: Tracks made while recording is off are shown. However, since tracks are not recorded, tracks are erased when the power is turned off or the track is not within the display area. Also, own ship tracks made while recording is off are erased whenever recording is restarted, or the display is zoomed in or out.

TRACK (1/2)	
1	BACK
2	EDIT TRACK
3	DELETE OWN TRACK
4	DELETE OTHER TRACK
5	CONV. TRACK TO RTE
6	DISP. STOPPED TRACKS OFF/ON
7	JOIN STOPPED TRACKS NO JOINT/JOIN
8	OWN TRACK SETTINGS
9	OTHER TRACK SETTINGS
0	NEXT

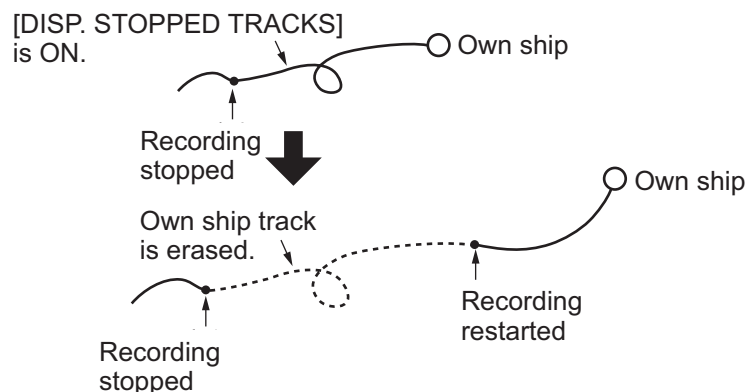

6. PLOTTER OPERATION (C-TYPES)

6. Close the menu.

How to connect non-recorded tracks after restarting recording

1. Open the menu.
2. Select [2 MARKS•PLOTTER].
3. Select [3 TRACK].
4. Select [7 JOIN STOPPED TRACKS].
5. Select [NO JOINT] or [JOIN] as required.
 - [NO JOINT]: The point where recording was stopped is not connected to the point where recording was resumed.
 - [JOIN]: The point where recording was stopped is connected to the point where recording was resumed.

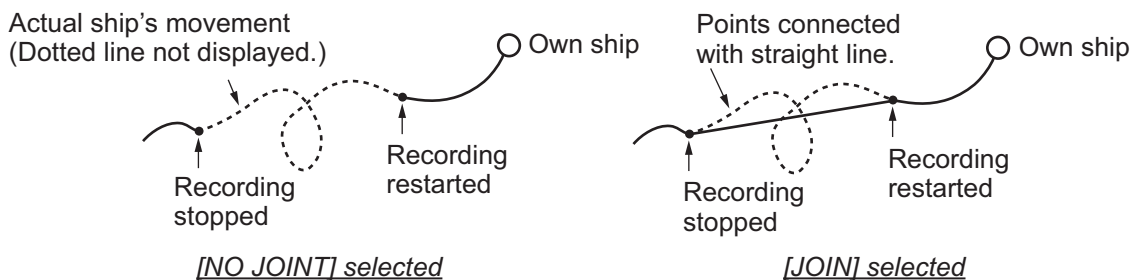

6. Close the menu.

6.1.4 How to stop and re-start tracks

You can stop, or “pause” tracks, then re-start the same track as desired.

1. Right-click within the radar effective radius to show the [CURSOR] menu.
2. Select [TRACK ON-OFF].
3. Select the vessel whose tracks you want to stop (or re-start), then left-click.
4. Right-click within the radar effective radius to complete the procedure.

6.1.5 How to change track color

Track color is available in seven colors: red, yellow, green, light blue, purple, blue, and white. For example, you may want to show track in red on the day you leave port to distinguish from track related to other activities. The own ship track color can be automatically changed according to water temperature or depth.

How to change own ship's track color

1. Right-click within the radar effective radius to show the [CURSOR] menu.
2. Select [TRACK COLOR].
3. Click within the radar effective radius. The [CHANGE TRACK COLOR] window appears.

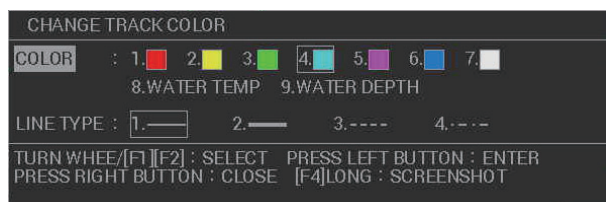

Note: For RCU-031 users, you can also press **TRACK COLOR** to open the [CHANGE TRACK COLOR] window.

4. Select [COLOR].
5. Select desired reference for track color.
 [WATER TEMP]: The track color changes according to water temperature. (Requires water temperature data.)
 [WATER DEPTH]: The track color changes according to depth. (Requires depth data.)
 The color of the track changes at the point when the new color is selected.
6. Close the window.

Note: You can also change the color partially, from the [EDIT TRACK] menu. See "How to change own ship's track color" on page 6-6.

How to change own ship's track color according to water temperature

If you selected [WATER TEMP] as the track color reference, the track changes color according to temperature changes in the water. This makes it easier to find changes in the temperature, which makes it easier to find specific fishing areas. There are two methods to change the track color:

- Method 1: change the color based on a temperature range
- Method 2: change the color based on a preset difference

Note: This feature requires valid water temperature data input.

Method 1: temperature-range-based color change

1. Open the menu.
2. Select [MARKS•PLOTTER].
3. Select [TRACK].
4. Select [OWN TRACK SETTINGS].
5. Select [NEXT].
6. Select [TRACK COLOR BY TEMP].
7. Select [RANGE].
8. Set the color for the temperature range.
 For example, to show water temperatures above 20 degrees centigrade in red color, do the following:
 - 1) Select [RED].
 - 2) Rotate the **scrollwheel** to set "+20.0", then press the **left button**.
 - 3) Set the other colors in a similar manner.

Note 1: The water temperature steps should be ascending order.

Note 2: Temperatures below the [BLUE] setting appear in white color.

9. Select [TEMP DATA DISPLAY].

OWN TRACK SETTINGS (2/3)	
1	BACK
2	TRACK COLOR BY TEMP [RANGE]/EV. 0.2/EV. 2.0
3	BLUE +05.0
4	MAGENTA +10.0
5	CYAN +12.5
6	GREEN +15.0
7	YELLOW +17.5
8	RED +20.0
9	TEMP DATA DISPLAY OFF/ON
0	NEXT

6. PLOTTER OPERATION (C-TYPES)

10. Select [ON] or [OFF] as required.
 - [ON]: Show water temperature on the track.
 - [OFF]: Hide water temperature on the track.
11. Close the menu.

Method 2: preset-difference-based color change

According to the setting, there are five colors which are used in a cycle to color the track. In the example figure below, the preset difference is set to [EV. 0.2] and the temperature ranges from 17.0°C to 18.2°C. The color changes every 0.2°C.

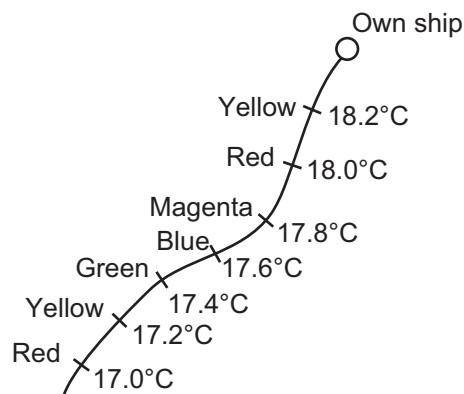

1. Open the menu.
2. Select [MARKS•PLOTTER].
3. Select [TRACK].
4. Select [OWN TRACK SETTINGS].
5. Select [NEXT].
6. Select [TRACK COLOR BY TEMP].
7. Select [EV. 0.2] or [EV. 2.0] as required.
 - [EV. 0.2]: changes the color with every temperature increase/decrease of 0.2°C.
 - [EV. 2.0]: changes the color with every temperature increase/decrease of 2.0°C.
8. Set the color for the temperature range.
For example, to show water temperatures above 18 degrees centigrade in red color, do the following:
 - 1) Select [RED].
 - 2) Rotate the **scrollwheel** to set "+18.0", then press the **left button**.
 - 3) Set the other colors in a similar manner.

Note 1: The water temperature steps should be in ascending order.

Note 2: Temperatures below the [BLUE] setting appear in white color.
9. Select [TEMP DATA DISPLAY].
10. Select [ON] or [OFF] as required.
 - [ON]: Show water temperature on the track.
 - [OFF]: Hide water temperature on the track.
11. Close the menu.

How to change own ship's track color according to depth

If you selected [WATER DEPTH] as the track color reference, the track changes color according to depth changes in the water. This makes it easier to see changes in depth directly below your boat. there are two methods to change the track color:

- Method 1: change the color based on a depth range
- Method 2: change the color based on a preset difference

Note: This feature requires valid depth data input.

Method 1: depth-range-based color change

This method gives depths within the same range the same color. For example, if you set the range between 200 m and 300 m, and the depth remains shallower than 300 m and deeper than 200 m, the color remains the same.

1. Open the menu.
2. Select [MARKS•PLOTTER].
3. Select [TRACK].
4. Select [OWN TRACK SETTINGS].
5. Select [NEXT] twice.
6. Select [TRACK COLOR BY DEPTH].
7. Select [RANGE].
8. Set the color for the depth range.
For example, to show depths from 400 m and below in red color, do the following:
 - 1) Select [RED].
 - 2) Rotate the **scrollwheel** to set "0400.0", then press the **left button**.
 - 3) Set the other colors in a similar manner.

Note 1: The depth intervals should be in ascending order.

Note 2: Depths below the [BLUE] setting appear in white color.
9. Select [DEPTH DATA DISPLAY].
10. Select [ON] or [OFF] as required.
 - [ON]: Show water temperature on the track.
 - [OFF]: Hide water temperature on the track.
11. Close the menu.

OWN TRACK SETTINGS (3/3)	
1	BACK
2	TRACK COLOR BY DEPTH RANGE/EV. 2/EV. 20/ EV. 200
3	BLUE 0010. 0
4	MAGENTA 0050. 0
5	CYAN 0100. 0
6	GREEN 0200. 0
7	YELLOW 0300. 0
8	RED 0400. 0
9	DEPTH DATA DISPLAY OFF/ON

6. PLOTTER OPERATION (C-TYPES)

Method 2: preset-difference-based color change

According to the setting, there are five colors which are used in a cycle to color the track. In the example figure below, set the preset difference is set to [EV. 2] and the Depth ranges from 170 m to 180 m. The color changes every 2 m.

1. Open the menu.
2. Select [MARKS•PLOTTER].
3. Select [TRACK].
4. Select [OWN TRACK SETTINGS].
5. Select [NEXT] twice.
6. Select [TRACK COLOR BY DEPTH].
7. Select [EV. 2], [EV. 20] or [EV. 200] as required.

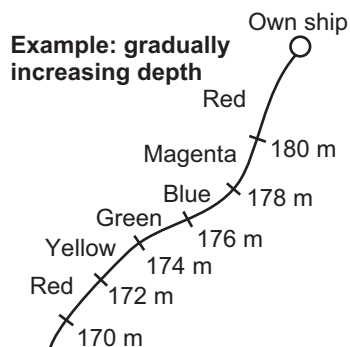

- [EV. 2]: changes the color with every depth increase/decrease of 2 m.
 - [EV. 20]: changes the color with every depth increase/decrease of 20 m.
 - [EV. 200]: changes the color with every depth increase/decrease of 200 m.
8. Select [DEPTH DATA DISPLAY].
 9. Select [ON] or [OFF] as required.
 - [ON]: Show water temperature on the track.
 - [OFF]: Hide water temperature on the track.
 10. Close the menu.

How to change own ship's track color based after a specified time

You can use the [AUTO COLOR CHANGE] feature to change your track color at a specific time.

1. Open the menu.
2. Select [MARKS•PLOTTER].
3. Select [TRACK].
4. Select [NEXT].
5. Select [AUTO COLOR CHANGE].
6. Select [ON] or [OFF] as required.
If you select [ON], the cursor moves to the time indication.
7. Set the time at which you want the track to change color.
Tracks will change colors every day at this time.
8. Close the menu.

How to change the color of other ships' tracks

1. Right-click within the radar effective radius to show the [CURSOR] menu.
2. Select [TRACK COLOR].
3. Select the ship whose track color you want to change. The [CHANGE TRACK COLOR] window appears.

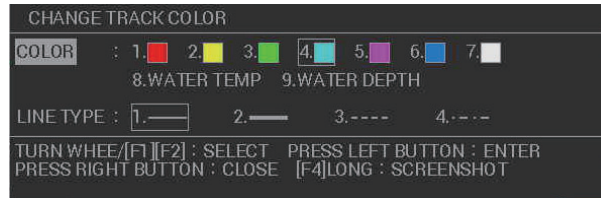

4. Select [COLOR].
5. Select the color used for the other ship's track.
Track color changes at this point, the previous color is retained for past tracks.
6. Close the menu.

6.1.6 How to show/hide own track based on color

You can show/hide sections of your track, based on the track color, with the following procedure.

Only tracks with the underlined colors are displayed on-screen.

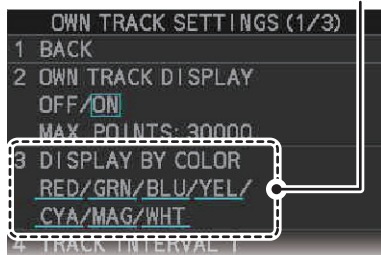

1. Open the menu.
2. Select [MARKS•PLOTTER].
3. Select [TRACK].
4. Select [OWN TRACK SETTINGS].
5. Select [DISPLAY BY COLOR].
6. Select the track color to show or hide.
Track colors indicated with a blue underline are shown, track colors with no underline are hidden.
7. Close the menu.

6.1.7 How to change the track line

You can select one of four line types for your own ship tracks and for other ship's tracks. The available line types are: normal (—), thick (—), dashed (----) and dash-dotted (-.-.-).

How to change line type for own ship's track

1. Right-click within the radar effective radius to show the [CURSOR] menu.
2. Select [TRACK COLOR].
3. Click within the radar effective radius to show the [CHANGE TRACK COLOR] window.

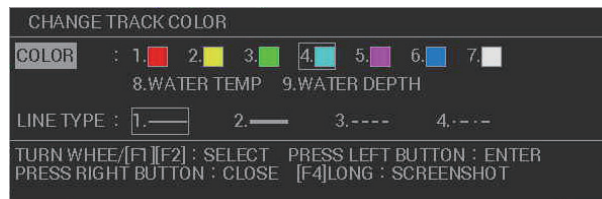

4. Select [LINE TYPE].
5. Select desired line type for own ship track.
The track line changes at this point, the previous line type is retained for past tracks.
6. Close the window.

Note: You can also change the line type partially, from the [EDIT TRACK] menu. See section 6.1.10.

How to change the color of other ships' tracks

1. Right-click within the radar effective radius to show the [CURSOR] menu.
2. Select [TRACK COLOR].
3. Click the ship whose track line you want to change. The [CHANGE TRACK COLOR] window appears.

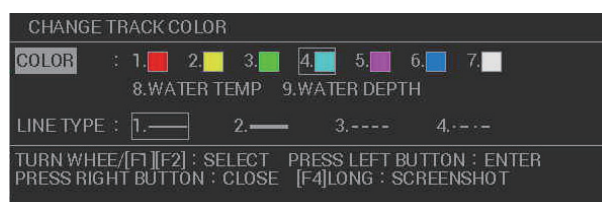

4. Select [LINE TYPE].
5. Select desired line type for own ship track.
The track line changes at this point, the previous line type is retained for past tracks.
6. Close the window.

6.1.8 How to set tracks recording method and interval

In order to display tracks for your own ship, as well as other vessels, the system records the position of your ship and other ships. A shorter recording interval gives clearer, smoother track lines, however the total time available for recording is reduced. On the other hand, a longer interval gives rougher tracks with longer recording time. When the track memory becomes full, the oldest tracks are deleted to make room for new tracks.

How to change the recording method for own ship's track

1. Right-click within the radar effective radius to show the [CURSOR] menu.
2. Select [TRACK ON-OFF].
3. Left-click within the radar effective radius to cycle through the recording methods, indicated at the top-left of the screen.
The indication cycles through the recording methods in the following order:
[TRACK INTERVAL 1] (⌘1) → [TRACK INTERVAL 2] (⌘2) → [HALT] (H) → [TRACK INTERVAL 1] (⌘1)....
4. Right-click to complete the procedure.

To change the settings for [TRACK INTERVAL 1] or [TRACK INTERVAL 2], follow the procedure outlined in "How to change the recording interval for own ship's track" on page 6-13.

How to change the recording interval for own ship's track

You can change the settings for the track recording interval to suit your requirements.

1. Open the menu.
2. Select [MARKS•PLOTTER].
3. Select [TRACK].
4. Select [OWN TRACK SETTINGS].
5. Select [TRACK INTERVAL 1] or [TRACK INTERVAL 2] as appropriate.
6. Select [TIME] or [RANGE]. The cursor moves to the associated setting.
7. Spin the scrollwheel to change the time or range, then left-click.
8. Close the menu.

How to change the recording interval for other ship's track

You can change the settings for the track recording interval to suit your requirements.

1. Open the menu.
2. Select [MARKS•PLOTTER].
3. Select [TRACK].
4. Select [OTHER TRACK SETTINGS].
5. Select [OTHER TRK REC INTVL].
6. Select [TIME] or [RANGE]. The cursor moves to the associated setting.
7. Spin the scrollwheel to change the time or range, then left-click.
Time and range are set to [0], the system records tracks at 1 second intervals.
8. Close the menu.

6.1.9 How to delete own ship tracks

You can delete the color or line type of the own ship's track. The area to be deleted can be selected with one of the following six methods.

- [BTWN 2PTS]: deletes the track line between the points specified with the cursor.
- [SET RNG]: deletes the track lines by color or line type within the specified area.
- [WITHIN RNG]: deletes the track lines displayed on the screen by color or line type.
- [OUT OF RNG]: deletes all track lines not displayed on the screen by color or line type.
- [ALL]: deletes all track lines by color or line type.
- [SET DATE]: deletes the track lines in a specified period, by color or line type.

Note 1: Use this function with care. Erased tracks cannot be restored.

Note 2: Recorded tracks which are selected at [ADD] from [PLAY OWN TRK] in the [INT. MEMORY PLAYBACK] menu (see section 1.59.2) cannot be deleted.

Note 3: When tracks are recorded and colored according to temperature or depth, and the color in use immediately before selecting the method to delete tracks is the same color, all temperature and depth tracks of that color will also be deleted.

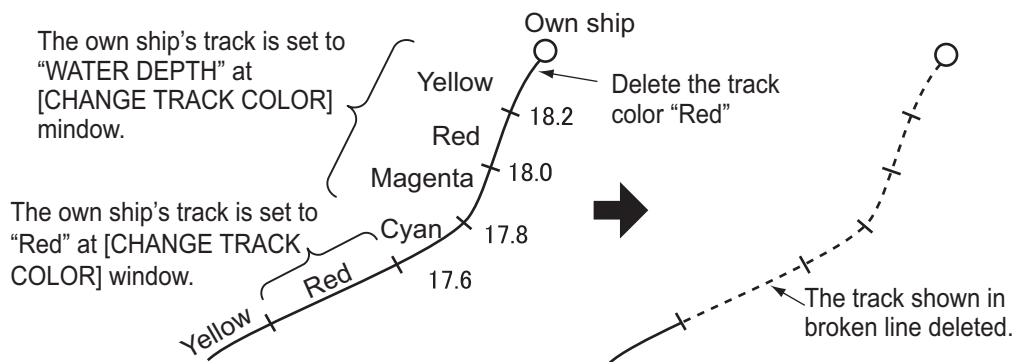

1. Open the menu.
2. Select [MARKS•PLOTTER].
3. Select [TRACK].
4. Select [DELETE OWN TRACK] to show the [DELETE OWN SHIP'S TRACK] window.

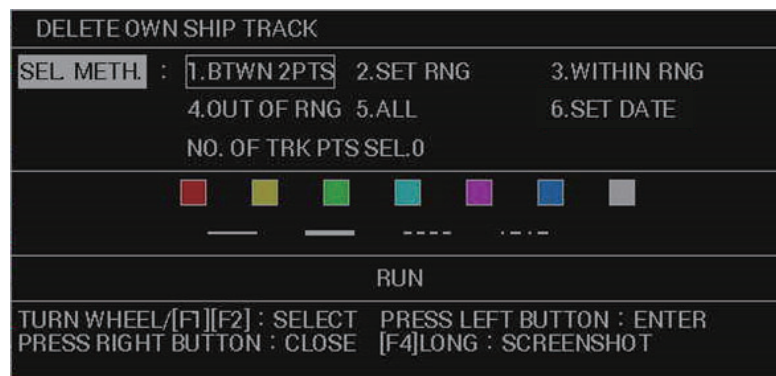

5. Select [SEL. METH.].
6. Select the method you want to use.
If you selected [BTWN 2PTS], [SET RNG] or [SET DATE], go to step 7. For all other selections, go to step 8.

7. Depending on your selection, do one of the following:

- [BTWN 2PTS]: Select start point and terminal point on the track with trackball. The track line between the two points will be deleted. Proceed to step 13.

Note: Both current track and playback track cannot be erased at the same time.

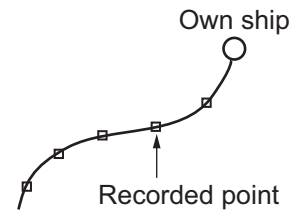

- [SET RNG]: Select start point and terminal point of the area to erase. The track points surrounded by the white frame are deleted. Proceed to step 8.

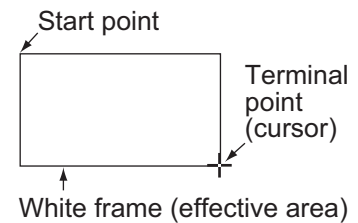

- [SET DATE]: Set [START DATE] and [END DATE] to specify the period, then select [ENTER]. Proceed to step 8.

DELETE OWN SHIP TRACK (SET DATE)	
START DATE	: 2019 / 10 / 31
END DATE	: 2019 / 10 / 31
ENTER	
TURN WHEEL/[F1][F2] : SELECT	PRESS LEFT BUTTON : ENTER
PRESS RIGHT BUTTON : CLOSE	[F4]LONG : SCREENSHOT

Note 1: [END DATE] must be later than [START DATE].

Note 2: If you do not set [START DATE]/[END DATE], the following track lines are deleted:

- If you set [START DATE] only, the track lines after the start date are deleted.
- If you set [END DATE] only, the track lines before the end date are deleted.
- If you set neither [START DATE] nor [END DATE], all track lines are deleted.

Note 3: The track lines to be deleted are selected according to the current date and time setting (UTC or local time). For details of the date and time setting, see section 1.13.

8. Select [COLOR].
9. Select the one or more track colors you want to delete. If you select ALL, all tracks with the specified colors will be deleted.
10. Select [LINE].
11. Select the one or more line types you want to delete. If you select [ALL], all tracks with the specified line types will be deleted.
12. Select [RUN]. The selected tracks are deleted.
13. Close the menu.

6.1.10 How to edit own ship's tracks

You can edit tracks after you reach port with one of the four methods listed below. Both current track and playback track cannot be edited at the same time.

- [BTWN 2PTS]: edit the track line between the points specified with the cursor.
- [SET RNG]: edit the track lines by color or line type within the specified area.
- [WITHIN RNG]: edit the track lines displayed on the screen by color or line type.
- [OUT OF RNG]: edit all track lines not displayed on the screen by color or line type.

Note 1: Recorded tracks which are selected at [ADD] from [PLAY OWN TRK] in the [INT. MEMORY PLAYBACK] menu cannot be deleted.

Note 2: When tracks are recorded and colored according to temperature or depth, and the color in use immediately before selecting the method to delete tracks is the same color, all temperature and depth tracks of that color will also be deleted.

1. Open the menu.
2. Select [MARKS•PLOTTER].
3. Select [TRACK].
4. Select [EDIT TRACK].
The [EDIT TRACK] window appears.
5. Select [SEL. METH.].
6. Select a the method you want to use.



7. Depending on your selection, do one of the following:
 - [BTWN 2PTS]: Select start point and terminal point on the track with trackball.
 - [SET RNG]: Select start point and terminal point of the area to edit.
8. Select [COLOR].
9. Select the color you want to change the selected tracks to. If you select [NO CHG.], the tracks retain their original color.
10. Select [LINE].
11. Select the line type you want to change the selected tracks to. If you select [NO CHG.], the tracks retain their original line type.
12. Select [RUN]. The selected changes are applied to the selected tracks.
13. Close the menu.

6.1.11 How to view information for consorts and GPS buoys

You can display GPS buoy and other ship's information on the screen.

Basic information

1. Press the **CURSOR DISP** key when the cursor is not shown.
2. Place the cursor on the target whose information you want to view.
The information for the selected target appears. If there is no data, [- -] appears.

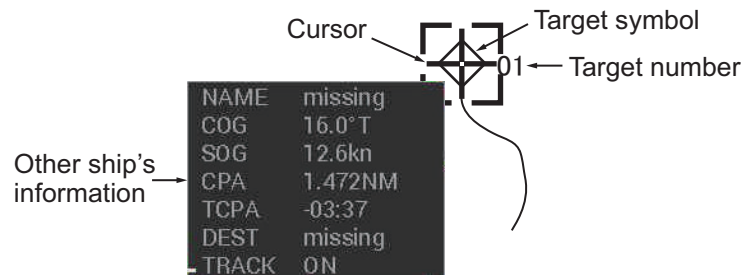

Note: If the target information is not shown, do the following procedure.

- 1) Open the menu.
- 2) Select [TT•AIS].
- 3) Select [CONSORT•GPS BUOY].
- 4) Select [TARGET POP UP INFO.].
- 5) Select [ON].
- 6) Close menu.

Detailed information

1. Place the cursor on the target whose information you want to view, then press the **right button**.
The target information box appears at the bottom of the screen.

CONSORT DETAIL INFO	
SHIP NAME	: FURUNOMARU
POSITION	: 00° 01.0000'N, 000° 02.0000'E
DISTANCE	: 0.000kyd DIR FM OS : 0.0°R
WATER TMP	: 0.0°C DEPTH : 0.0m
CURRENT1	: 1LYR ---.mph ---.°T
CURRENT2	: 2LYR ---.mph ---.°T
CURRENT3	: 3LYR ---.mph ---.°T
FISHSIZE	: ---cm
PRESS RIGHT BUTTON : CLOSE	
[F4]LONG : SCREENSHOT	

2. Press the **right button** to close the information box.

Consort list

1. Open the menu.
2. Select [TT•AIS].
3. Select [CONSORT•GPS BUOY].

6. PLOTTER OPERATION (C-TYPES)

4. Select [CONSORT LIST]. The [CONSORT LIST] appears.

CONSORT LIST			SEL PAGE _ 1/1	
NAME OF SHIP	DISTANCE	DIR FM OS	TCPA	CPA
FURUNOMARU	0.000kyd	0.0°R	--m-s	---kyd
[F1] : CHANGE COLOR PRESS RIGHT BUTTON : CLOSE PRESS LEFT BUTTON : SELECT TARGET [F2] : RECORD START/STOP [0]-[9]/[F3][F4] : PAGE NO/MOVE PAGE [F4]LONG : SCREENSHOT				

The following operations are available from the [CONSORT LIST].

- Change the selected consort ship’s track color: press **F1**. For procedure details, see section 6.1.5 and section 6.1.7.
- View a consort ship’s details: select the consort, then press the **left button**.
- Start/stop track recording for the selected consort ship: press **F2**.
- Take a screenshot of the consort list: press and hold **F4**. This requires a SD Card inserted in the card slot of the processor unit.
- Change the selected page (when more than one page of the list is available): press the desired page number on the control unit, or press **F3** to go back one page, **F4** to go forward one page.
- Close the list: press the **right button**.

GPS buoy

1. Open the menu.
2. Select [TT•AIS].
3. Select [CONSORT•GPS BUOY].
4. Select [GPS BUOY LIST], then press the **left button**. The GPS buoy list appears.

GPS BUOY LIST			SEL PAGE _ 1/1	
ID	POSITION	DISTANCE	DIR FM OS	
1	00° 01.0000'N,000° 04.0000'E	4.131NM	76.0° R	
2	00° 02.0000'N,000° 04.0000'E	4.480NM	63.4° R	
3	00° 03.0000'N,000° 04.0000'E	5.009NM	53.1° R	
4	00° 04.0000'N,000° 04.0000'E	5.667NM	45.0° R	
5	00° 05.0000'N,000° 04.0000'E	6.415NM	38.7° R	
[F1] : CHANGE COLOR PRESS RIGHT BUTTON : CLOSE PRESS LEFT BUTTON : SELECT TARGET [F2] : RECORD START/STOP [0]-[9]/[F3][F4] : PAGE NO/MOVE PAGE [F4]LONG : SCREENSHOT				

The following operations are available from the [CONSORT LIST].

- Change the selected buoy’s track color: press **F1**. For procedure details, see section 6.1.5 and section 6.1.7.

- View a buoy's details: select the buoy, then press the **left button**.
- Start/stop track recording for the selected buoy: press **F2**.
- Take a screenshot of the list: press and hold **F4**.
This requires a SD Card inserted in the card slot of the processor unit.
- Change the selected page (when more than one page of the list is available):
press the desired page number on the control unit, or press **F3** to go back one page, **F4** to go forward one page.
- Close the list: press the **right button**.

6.1.12 How to delete other ship's tracks

1. Open the menu.
2. Select [MARKS•PLOTTER].
3. Select [TRACK].
4. Select [DELETE OTHER TRACK] to show the [DELETE OTHER SHIPS' TRACK] window.

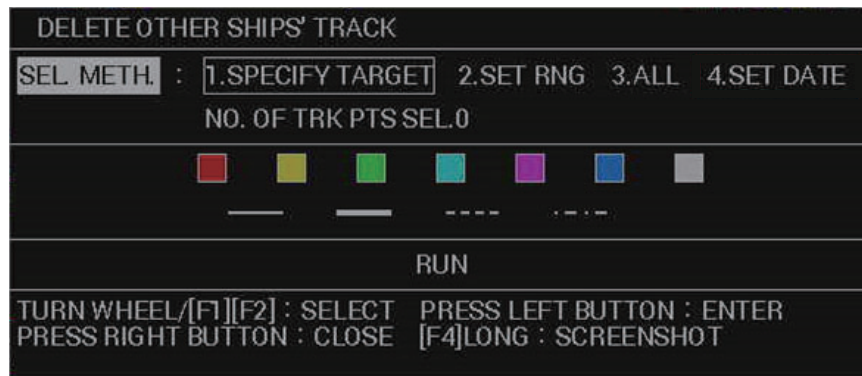

5. Select [SEL. METH.].
6. Select the method you want to use.
 - [SPECIFY TARGET]: delete only the tracks of the specified target. Go to step 7.
 - [SET RNG]: deletes the track lines by color or line type within the specified area. Go to step 7.
 - [ALL]: deletes all target tracks that match the specified color and line type. Go to step 8.
 - [SET DATE]: deletes the track lines in a specified period, by color or line type. Go to step 7.
7. Depending on your selection, do one of the following:
 - [SPECIFY TARGET]: Place the cursor on the target whose tracks you want to delete, then left-click.
 - [SET RNG]: Select start point and terminal point of the area to erase. The track points surrounded by the white frame are deleted.

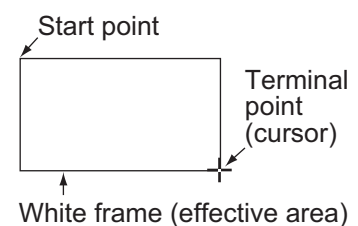

6. PLOTTER OPERATION (C-TYPES)

- [SET DATE]: Set [START DATE] and [END DATE] to specify the period, then select [ENTER].

```
DELETE OWN SHIP TRACK (SET DATE)
START DATE   : 2019 / 10 / 31
END DATE     : 2019 / 10 / 31
ENTER
TURN WHEEL/[F1][F2] : SELECT  PRESS LEFT BUTTON : ENTER
PRESS RIGHT BUTTON : CLOSE   [F4]LONG : SCREENSHOT
```

Note 1: [END DATE] must be later than [START DATE].

Note 2: If you do not set [START DATE]/[END DATE], the following track lines are deleted:

- If you set [START DATE] only, the track lines after the start date are deleted.
- If you set [END DATE] only, the track lines before the end date are deleted.
- If you set neither [START DATE] nor [END DATE], all track lines are deleted.

Note 3: The track lines to be deleted are selected according to the current date and time setting (UTC or local time). For details of the date and time setting, see section 1.13.

8. Select [COLOR].
9. Select the color you want to change the selected tracks to. If you select [NO CHG.], the tracks retain their original color.
10. Select [LINE].
11. Select the line type you want to change the selected tracks to. If you select [NO CHG.], the tracks retain their original line type.
12. Select [RUN]. The selected changes are applied to the selected tracks.
13. Close the menu.

6.2 Marks

Up to 30,000 marks can be used to indicate the location of fish schools, shallows, buoys and other points of interest. You can connect marks with a line or place square/circular marks over a designated area.

6.2.1 How to set up marks

You can set the color, shape, line type, size and fish type to use as marks.

Mark color, shape and line type

You can set up to mark with the following procedure.

1. Open the menu.
2. Select [MARKS•PLOTTER].

3. Select [MARK]. The [MARK] menu appears.

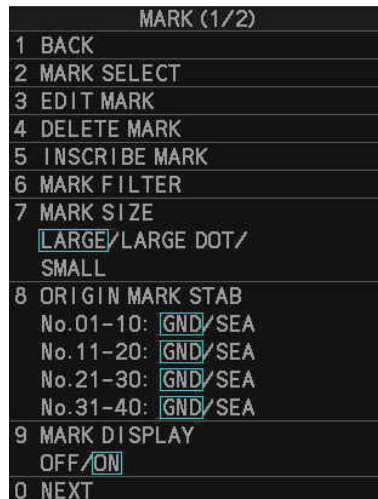

Note: You can also access the [MARK] menu from the [MARK] box. Place the cursor on the [MARK] box, then right-click.

4. Select [MARK SELECT]. The [MARK COLOR/SHAPE] window appears.



The currently selected mark's shape appears in the [MARK] box at the bottom-left corner of the screen.

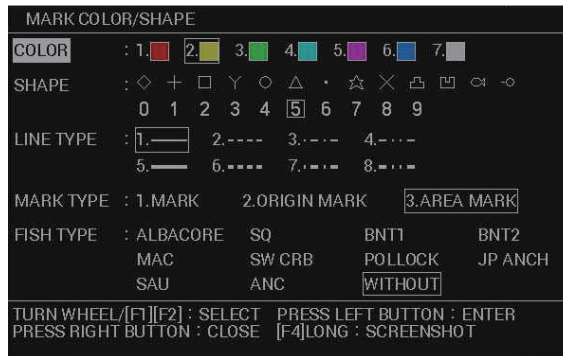

Note: When [MARK TYPE] is set to [ORIGIN MARK or AREA MARK], [SHAPE] and [FISH TYPE] cannot be changed.

5. Select [COLOR].
6. Select the color you want to use.
7. Select [SHAPE].
8. Select the shape you want to use.
9. Select [LINE TYPE].
10. Select the type of line you want to use for connected marks.
The line type selected here is used for the lines between connected marks and as the boundary for area marks.
 - **For connected marks:** The line appears when the procedure outlined at "Entering connected marks" on page 6-24 is followed.
 - **For area marks:** The boundary shape appears when the procedure outline at "Entering area marks" on page 6-24 is followed.
11. Select [MARK TYPE].
12. Select [MARK] to use connected marks and normal marks, select [AREA MARK] to use area marks. The indications in the [MARK] box change according to your selection.
13. Close the window.

6. PLOTTER OPERATION (C-TYPES)

Note: You can also change the mark attributes directly from the [MARK] box. Place the cursor on the item you want to change, then spin the scrollwheel or left-click to cycle through the options. Changes made in this manner are also reflected on the [MARK COLOR/SHAPE] window.

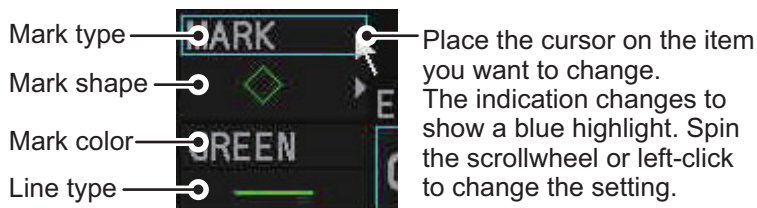

Mark size

You can set the mark sizes as [LARGE], [LARGE DOT] or [SMALL].

1. Open the menu.
2. Select [MARKS•PLOTTER].
3. Select [MARK].
4. Select [MARK SIZE].
5. Select the desired mark size.



LARGE



LARGE DOT



SMALL

6. Close the menu.

Fish marks

You can assign a fish type to a mark and also hide the fish mark with the mark filter. For how to use the mark filter, see section 6.2.6.

1. Open the menu.
2. Select [MARKS•PLOTTER].
3. Select [MARK].
4. Select [MARK SIZE].
5. Select [MARK SELECT].
6. Select [FISH TYPE].
7. Select the type of fish you want to assign to the mark.
If you select [WITHOUT], no fish type is assigned to the mark.

Note: You can change the names listed under [FISH TYPE]. Select the name you want to change, then press **F3**. Referring to section 1.5.3, assign a new name to the fish type (max. 10 characters). This name change is applied to all other locations where fish type appears.

8. Close the menu.

6.2.2 How to enter marks and lines

You can enter marks with one of the following methods:

- Enter a mark, connected mark (line) or area mark at the cursor location
- Enter the latitude/longitude for the mark location (not available for connected marks and area marks)

Note: If marks do not appear on-screen, check the following:

- Is [MARK DISPLAY] turned on? Check [MAIN MENU] → [MARKS•PLOTTER] → [MARK] menu. If the setting is [OFF], set to [ON].
- Is the MAP button on the InstantAccess bar™ set to [ON]? If the button shows [MAP OFF], left-click the button to show [MAP ON].
- Is the mark filtered? Check the filter settings, referring to section 6.2.6. If the mark is filtered, disable the filter.

Entering a mark at the cursor location

You can enter marks at the cursor location with one of the following methods:

- Method 1: Using the keys on the control unit.
 - 1) Place the cursor on the location you want to mark.
 - 2) Press the **ENTER MARK** key.
The mark selected at section 6.2.1 appears at the cursor location.
- Method 2: Using the on-screen boxes and menus.
 - 1) Place the cursor on the mark type in the [MARK] box.
 - 2) Spin the scrollwheel or left-click to select [MARK].
 - 3) Place the cursor on the mark shape.
 - 4) Spin the scrollwheel to select a mark.
Note: If you use method 1 after selecting a mark in the [MARK] box using method 2, the mark that appears on-screen is the mark selected in the [MARK] box.
 - 5) Left-click the [MARK] box. The cursor color changes and the [INPUT MARK GUIDE] window appears.

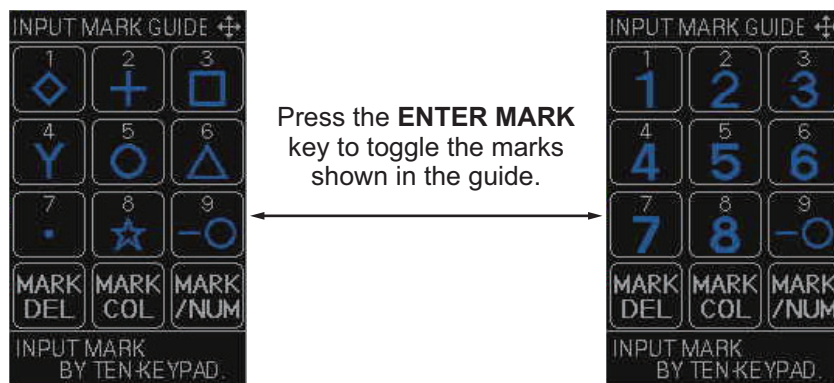

How to use the [INPUT MARK GUIDE] window

The control unit's numeric keys, **CANCEL TRAILS**, **BRILL** and **ENTER MARK** keys are used with the [INPUT MARK GUIDE] window.

- **1** key through to **9** key: Enter the corresponding mark at the cursor location.
- **CANCEL TRAILS** key: Delete the mark highlighted with the cursor.
- **BRILL** key: Toggle the window display to show color selections for marks.
If a mark is highlighted with the cursor when you press the **BRILL** key, the [EDIT MARK] window appears.
- **ENTER MARK** key: Toggles the marks shown in the [INPUT MARK GUIDE] window. This button has no function if the [INPUT MARK GUIDE] window shows the color selections.
 - 6) Do one of the following:
 - Place the cursor on the location you want to mark, then left-click. The mark shown in the [MARK] box appears.

6. PLOTTER OPERATION (C-TYPES)

- Place the cursor on the location you want to mark, then press the numeric key, on the control unit, that corresponds to the mark you want to enter. The selected mark appears.

7) Right-click to close the [INPUT MARK GUIDE] window.

Entering connected marks

Connected marks show each mark symbol, connected with a line. This feature can be used to mark areas, potential routes or net drop locations.

- Place the cursor on the mark type in the [MARK] box.
- Spin the scrollwheel or left-click to select [MARK].
- Place the cursor on the mark shape.
- Spin the scrollwheel to select the connected mark symbol (—○), then left-click. The cursor changes color.
- Place the cursor on the location you want to mark, then left-click. If one or more marks already exist, a line appears between the last mark and the new mark. The cursor pop up information shows the range and bearing from the last mark.

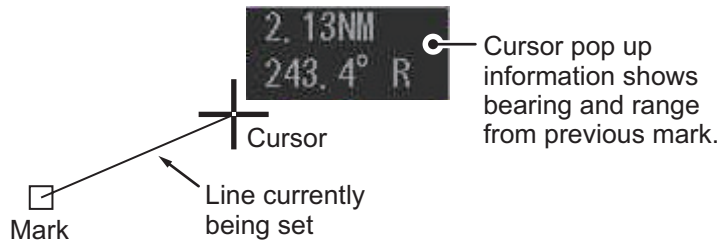

- Repeat step 3 as required until the line of marks is completed.
- Right-click to complete the procedure.

Entering area marks

- Place the cursor on the mark type in the [MARK] box.
- Spin the scrollwheel or left-click to select [AREA MARK].
- Place the cursor on the mark shape.
- Spin the scrollwheel to select the area mark.

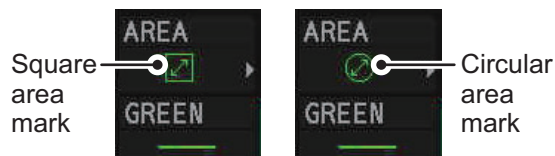

- Left-click to confirm the selection. The area mark details pop up window appears. The contents of the window depend on the area mark selected, as shown below.



- Spin the scrollwheel to set the [HEIGHT] or [RANGE] as required, then press the scrollwheel to move to the next setting. The area mark changes dynamically to reflect each change in the settings.

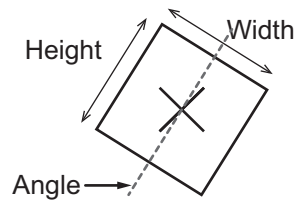

Square area mark

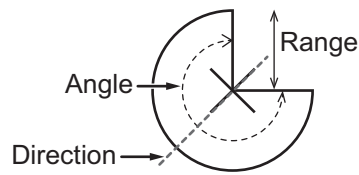

Circular area mark

- Set the other details in the same manner as in step 6.
- Move the cursor to the location where you want to insert the mark, then left-click.

Entering marks at a specified latitude/longitude

- Open the menu.
- Select [MARKS•PLOTTER].
- Select [MARK].
- Select [INSCRIBE MARK].
The [INPUT MARK] window appears.
- Select [LATITUDE].
- Enter the latitude at which you want to enter the mark.
You can spin the scrollwheel, then left-click to enter a numeral, or press the corresponding number key on the control unit.
- Set the longitude in a similar manner.
- Select [COLOR].
- Select the color you want to use.
- Select [SHAPE].
- Select the shape you want to use.
- Select [LINE TYPE].
- Select the type of line you want to use for connected marks.
- Select [FISH TYPE].
- Select the type of fish you want to assign to the mark.

If you select [WITHOUT], no fish type is assigned to the mark.

Note: You can change the names listed under [FISH TYPE]. Select the name you want to change, then press **F3**. Referring to section 1.5.3, assign a new name to the fish type (max. 10 characters). This name change is applied to all other locations where fish type appears.

- Close the window.

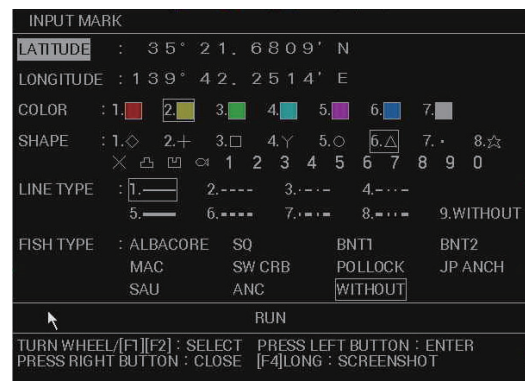

6.2.3 How to delete marks and lines

You can delete marks and lines from the menu or on the screen.

When you use the menu to delete marks, you can specify the mark color, shape or fish type to delete.

Note: Recorded tracks which are selected at [ADD] from [PLAY OWN TRK] in the [INT. MEMORY PLAYBACK] menu (see section 1.59.2) cannot be deleted.

Deleting marks on-screen

You can delete marks on the screen with one of the following methods.

Note: If a marks is not deleted when you complete one of the following procedures, it is possible that there are multiple marks on the same location. Repeat the procedure.

- Method 1: Use the **TARGET CANCEL** key.
 1. Place the cursor on the mark you want to delete, then press the **TARGET CANCEL** key.

When the cursor is placed on a mark, the cursor shape changes as shown in the figure to the right.



2. Repeat as required.
- Method 2: Use the [CURSOR] menu.
 1. Right-click within the radar effective radius to show the [CURSOR] menu.
 2. Select [MARK DELETE].
 3. Place the cursor on the mark you want to delete, then left-click.
 4. Repeat as required.
 - Method 3: Use the [INPUT MARK GUIDE] window.

Note: Connected marks (lines) and area marks cannot be deleted with this method.

 1. Left-click the [MARK] box to show the [INPUT MARK GUIDE] window.
 2. Place the cursor on the mark you want to delete.
 3. Press the **CANCEL TRAILS** key.
 4. Repeat as required.
 5. Right-click to close the window.
 - Method 4: Use the [DELETE MARK] window.
 1. Open the menu.
 2. Select [MARKS•PLOTTER].
 3. Select [MARK].

4. Select [DELETE MARK]. The [DELETE MARK] window appears.

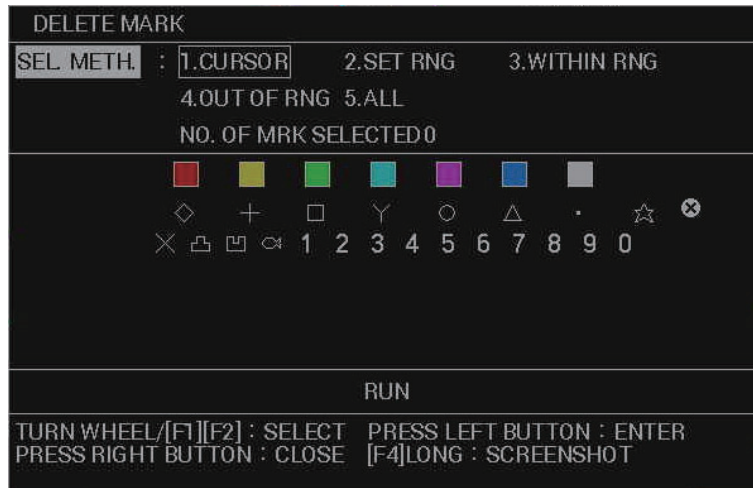

5. Select [SEL. METHOD].
6. Select the method you want to use to delete marks.
- [CURSOR]: deletes the mark or line selected with the cursor.
 - [SET RNG]: deletes all marks and lines by color or line type within the specified area.
 - [WITHIN RNG]: deletes the marks and lines displayed on the screen by color or line type.
 - [OUT OF RNG]: deletes all marks and lines not displayed on the screen by color or line type.
 - [ALL]: deletes all marks and lines by color or line type.

If you selected [CURSOR] or [SET RNG], go to step 7. For all other options, go to step 8.

7. Depending on your selection, do one of the following:
- [CURSOR]: Place the cursor on the mark to delete, then left-click. Repeat as required, then close the window.
 - [SET RNG]: Set the area in which you want to delete marks. Left-click the starting point of the area, then left-click the end point of the area.
8. Select [COLOR].
9. Select the color of the mark(s) you want to delete.
If you select [ALL], all marks which match the other criteria are deleted, regardless of color.
10. Select [SHAPE].
11. Select the shape of the marks you want to delete.
If you select [ALL], all marks which match the other criteria are deleted, regardless of shape.
12. Select [FISH TYPE].
13. Select the fish type for the marks you want to delete.
If you select [WITHOUT], only marks which are not assigned a fish type, and meet the other criteria, are deleted.
If you select [ALL], all marks which match the other criteria are deleted, regardless of fish type.
14. Select [RUN]. Marks that meet your criteria are deleted and the window closes automatically.

6.2.4 How to edit marks and lines

1. Open the menu.
2. Select [MARKS•PLOTTER].
3. Select [MARK].
4. Select [EDIT MARK].
The [EDIT MARK] window appears.

EDIT MARK			
SEL. METH.	: 1.CURSOR	2.SET RNG	3.WITHIN RNG
	4.OUT OF RNG		
	NO. OF MRK SELECTED 17		
COLOR	: 1. 	2. 	3. 
	4. 	5. 	6. 
	7. 	8. NO CHG.	
SHAPE	: 1. 	2. 	3. 
	4. 	5. 	6. 
	7. 	8. 	9. 
			
		1	2
	3	4	5
	6	7	8
	9	0	NO CHG.
LINE TYPE	: 1. 	2. 	3. 
	4. 	5. 	
	6. 	7. 	8. 
	9. NO CHG.		
FISH TYPE	: ALBACORE	SQ	BNT1
	MAC	SW CRB	POLLOCK
	SAU	ANC	WITHOUT
			NO CHG.
COMMENT	: _____	NO CHG.	
RUN			
TURN WHEEL/[F1][F2]: SELECT PRESS LEFT BUTTON: ENTER			
PRESS RIGHT BUTTON: BACK [F4]LONG: SCREENSHOT			

Note: When [MARK TYPE] is set to [ORIGIN MARK or AREA MARK], [SHAPE] and [FISH TYPE] cannot be changed.

5. Select [SEL. METH.].
6. Select the method you want to use to delete marks.
 - [CURSOR]: edits the mark or line selected with the cursor.
 - [SET RNG]: edits all marks and lines by color or line type within the specified area.
 - [WITHIN RNG]: edits the marks and lines displayed on the screen by color or line type.
 - [OUT OF RNG]: edits all marks and lines not displayed on the screen by color or line type.

If you selected [CURSOR] or [SET RNG], go to step 7. For all other options, go to step 8.

7. Depending on your selection, do one of the following:
 - [CURSOR]: Place the cursor on the mark to edit, then left-click. Repeat as required, then close the window.
 - [SET RNG]: Set the area in which you want to delete edit. Left-click the starting point of the area, then left-click the end point of the area.
8. Select [COLOR].
9. Select the color you want to change the selected marks to. If you select [NO CHG.], the marks retain their original color.
10. Select [SHAPE].
11. Select the mark shape you want to change the selected marks to. If you select [NO CHG.], the marks retain their original shape.
12. Select [LINE TYPE].

13. Select the line type you want to change the selected marks to. If you select [NO CHG.], the marks retain their original line type.
14. Select [FISH TYPE].
15. Select the type of fish you want to assign to the mark.
If you select [NO CHG.], the marks retain their original fish type.
If you select [WITHOUT], marks with no fish type assigned are edited.
Note: You can change the names listed under [FISH TYPE]. Select the name you want to change, then press **F3**. Referring to section 1.5.3, assign a new name to the fish type (max. 10 characters). This name change is applied to all other locations where fish type appears.
16. Select [COMMENT].
17. Referring to section 1.5.3, edit the comment as required. If you select [NO CHG.], the marks retain their original comment.
18. Select [RUN]. The selected changes are applied to the selected marks.
19. Close the menu.

6.2.5 How to view mark and line information

You can view the information for marks in either pop up or detailed format.

Viewing mark information in pop up format

The pop up window shows basic mark information (latitude, longitude, water temperature, depth and comment).

Place the cursor on a mark to view its basic information.

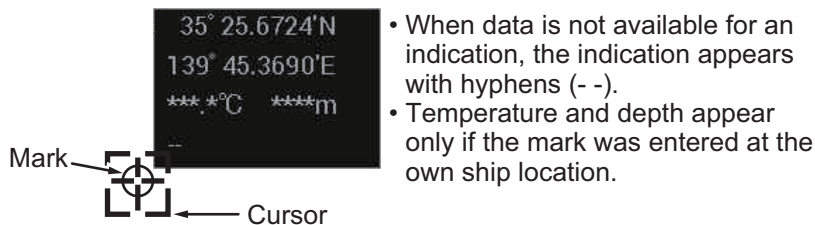

For area marks, the basic information also shows the coordinates, comment and dimensions of the area.

```
35° 20.4350'N
139° 39.8338'E
-
HEIGHT 0.138NM
WIDTH 0.138NM
ANGLE 000°T
```

Square area mark pop-up

```
35° 18.2577'N
139° 42.0538'E
-
RANGE 0.187NM
ANGLE 280°T
DIR 000°T
```

Circle area mark pop-up

Note 1: The mark comment only appears in pop up information with the following menu settings: [MAIN] menu → [MARKS•PLOTTER] → [MARK] → [NEXT] → [SHOW MARK COMMENTS] → [ON CHART] or [IN POP UP INFO].

Note 2: The pop up information only appears with the following menu setting: [MAIN] menu → [MARKS•PLOTTER] → [MARK] → [NEXT] → [MARK CURSOR INFO.] → [ON].

6. PLOTTER OPERATION (C-TYPES)

Viewing detailed mark information

Place the cursor on the mark whose information you want to view, then right-click. The mark's detailed information appears at the bottom of the screen.

Note: Detailed mark information using this method is not available for area marks.

MARK INFORMATION	
POSITION	: 35° 25.6724'N 139° 45.3690'E
DATE	: 2017/06/15 08:01
COMMENT	: --
FISH TYP	: POLLOCK
MOON AGE	: --
TIDE	: +-m --
TEMP	: ***.°C
DEPTH	: ***m
COMP	: --
DRIFT	: --.° ***.kn
TIDAL CURRENT:	: --.° ***.kn

PRESS RIGHT BUTTON : CLOSE
[F1] : EDIT MARK [F4]LONG : SCREENSHOT

- When data is not available for an indication, the indication appears with hyphens (- -).
- Temperature and depth appear only if the mark was entered at the own ship location.

With the detailed information displayed, press the **F1** key to edit the mark, or press **F4** to take a screenshot.

To close the information, press the **right button**.

Methods for comment display

You can set how to show mark comments with the following procedure.

[MAIN] menu → [MARKS•PLOTTER] → [MARK] → [NEXT] → [SHOW MARK COMMENTS] → [ON CHART] or [IN POP UP INFO]

1. Open the menu.
2. Select [MARKS•PLOTTER].
3. Select [MARK].
4. Select [NEXT].
5. Select [SHOW MARK COMMENTS].
6. Select the desired display method.
 - [ON CHART]: mark comment is always visible, directly above the mark
 - [IN POP UP INFO]: mark comment appears in a pop up window when the cursor is placed on the mark.
 - [IN INFORMATION]: mark comment is displayed in the information area, at the right-hand side of the screen, when you right-click the mark.
7. Close the menu.

6.2.6 Mark filter

The mark filter lets you show and hide marks based on your settings.

Note: The mark filter is not available under the following circumstances:

- The [MAP ON/OFF] button shows "MAP OFF".
- Heading data is not input.
- Position data is not input.

How to activate the mark filter

1. Open the menu.
2. Select [MARKS•PLOTTER].
3. Select [MARK].
4. Select [MARK FILTER].

The mark filter settings appear at the mid-left side of the screen, below the [ACE] button.

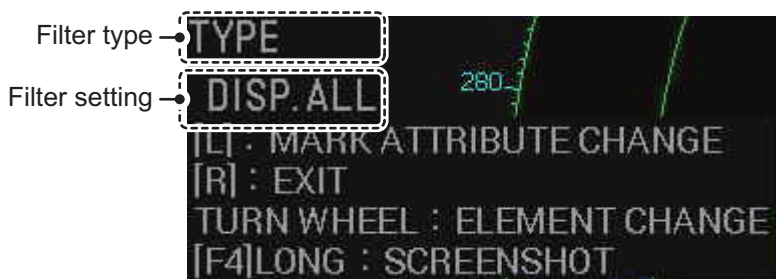

5. Press the left button to cycle through the filter types and select the required filter. The filter types cycle in the following order: [DISP. ALL] → [TYPE] → [COLOR] → [SHAPE] → [DATE] → [COMP] → [TEMP] → [DEPTH] → [L.AGE] → [TIDE] → [C.DIR] → [C.SPD] → [MULTI] → [DISP.ALL]... You can hide filter types (and their settings) from the menu, removing them from the above cycle. To hide filter types, see the "How to show/hide filter settings from the display cycle" on page 6-33 which follows directly after this topic.
6. Spin the scrollwheel to select the filter setting you want to use. Only marks that match the filter settings appear on the screen.



Filter: Bottom composition (COMP)
Filtered composition: SAND



Filter: Water temperature (TEMP)
Filtered temperature: 1.1°C

Filter type	Filter settings	Description
Blank.	[DISP ALL]	No filter. All marks are shown.
[TYPE]	[DISP ALL], fish types set to ON in the [MARK FILTERS(FISH)] menu.	Marks that match the selected fish type are shown.
[COLOR]	[DISP ALL], [RED], [YELLOW], [GREEN], [LIGHT BLUE], [PURPLE], [BLUE], [WHITE]	Marks that match the selected color are shown.
<i>Continued on following page</i>		

6. PLOTTER OPERATION (C-TYPES)

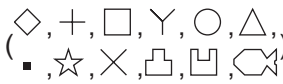
Filter type	Filter settings	Description
<i>Continued from previous page</i>		
[SHAPE]	[DISP ALL], the following symbols  , [1], [2], [3], [4], [5], [6], [7], [8], [9], [0]	Marks that match the selected shape are shown.
[DATE]	[DISP. ALL], [THE PAST WEEK], [THE PAST MONTH], [THE PAST YEAR], [THIS PERIOD], [THIS TIME], mm/dd to mm/dd, mm/dd to [CURR.] (current)	Marks that match the selected date filter are shown.
[COMP]	[DISP. ALL], [MUD], [SAND], [GRAVEL], [ROCK]	Marks that match the selected seabed composition are shown.
[TEMP]	[DISP. ALL], [0.0 °C] to [30.0 °C] in 0.1 °C steps	Marks that match the are within ±0.5°C of the filter setting are shown. When 0.0°C (minimum) is set, marks with a temperature below 0.0°C are shown, and when 30.0°C (maximum) is set, marks with a temperature above 30.0°C are shown.
[DEPTH]	[DISP. ALL], [0.0 m] to [200 m] in 5 m steps below 100 m, 10 m steps over 100 m	If the mark has depth information, and the depth is 100 m or less, depth marks are shown within a ±2.5 m deviation from the filter setting. Marks with a depth of over 100 m marks are shown with a ±5 m deviation. Where the filter is set to minimum/maximum, only depths the match, or are less/more respectively, are shown.
[L.AGE]	[DISP. ALL], [0] to [30]	If the mark has moon age data, marks within ±1 of the filter setting are shown.
[TIDE]	[DISP. ALL], [LOW TIDE], [30% UP], [50% UP], [70% UP], [HIGH TIDE], [30% LOW], [50% LOW], [70% LOW]	If the mark has a tide data, marks with the specified tide level marks are shown.
[C.DIR]	[DISP. ALL], [0.0 °T] to [350.0 °T] in 10° steps	Marks with a tidal current direction within ±10° of the filter setting are shown.
[C.SPD]	[DISP. ALL], [0.0 kn] to [5.0 kn] in 0.2 kn steps	Marks with a tidal current speed that match the filter setting exactly are shown. If the maximum speed is set, only marks that exceed the filter setting are shown.
[MULTI]	[MULTI DISP]	Combines all the filter settings into a multi-filter. Marks that match all the above criteria are shown.

Note: Filter settings are not applied to marks entered after the filters are set.

7. Right-click to complete the procedure.

Note: You can disable the filters, and hide the filter settings, by using above procedure, then selecting [DISP ALL] as the filter type. The [DISP. ALL] indication disappears after a few seconds.

How to show/hide filter settings from the display cycle

You can remove, or add filter types to the filter type display cycle. Items removed from the cycle do not appear at the mid-left side of the screen when you access the filter types.

1. Open the menu.
2. Select [MARKS•PLOTTER].
3. Select [MARK].
4. Select [NEXT].
5. Select [MARK FILTERS]. The [MARK FILTERS] menu appears. This menu has two pages, as shown in the following figure.

MARK FILTERS (1/2)		MARK FILTERS (2/2)	
1	BACK	1	BACK
2	FISH TYPE OFF/ON	2	TIDE LEVEL OFF/ON
3	COLOR OFF/ON	3	CURRENT DIRECTION OFF/ON
4	SHAPE OFF/ON	4	CURRENT SPEED OFF/ON
5	DATE OFF/ON	5	MULTI OFF/ON
6	SEABED COMPOSITION OFF/ON		
7	WATER TEMPERATURE OFF/ON		
8	DEPTH OFF/ON		
9	MOON AGE OFF/ON		
0	NEXT		

Page 1

Page 2

6. Select the item you want to show or hide from the filters types.
7. Select [OFF] to hide the item, [ON] to show the item in the filter types. Only the items set to [ON] will appear in the filter types cycle.
8. Close the menu.

6. PLOTTER OPERATION (C-TYPES)

How to show/hide fish filter types

You can remove, or add, fish filter types. These filter types appear in the [EDIT MARK] and [MARK COLOR/SHAPE] windows.

1. Open the menu.
2. Select [MARKS•PLOTTER].
3. Select [MARK].
4. Select [NEXT].
5. Select [MARK FILTERS(FISH)]. The [MARK FILTERS(FISH)] menu appears. This menu has two pages, as shown in the following figure.

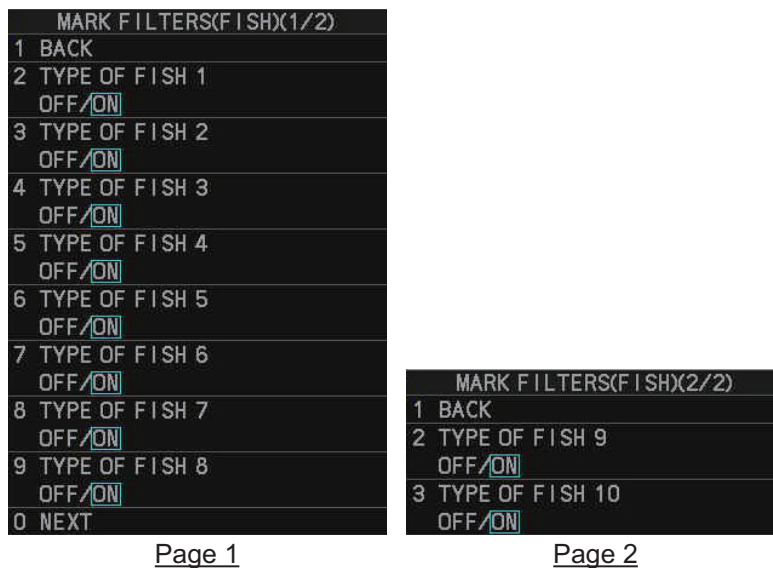

6. Select the item you want to show or hide from the filters types.
7. Select [OFF] to hide the item, [ON] to show the item in the filter types. Only the items set to [ON] will appear in the [EDIT MARK] and [MARK COLOR/SHAPE] windows.
8. Close the menu.

How to set up the date/time filter

If you select DATE as the filter type, the filter settings appear in the following cyclic order:

[DISP. ALL] → [THE PAST WEEK] → [THE PAST MONTH] → [THE PAST YEAR] → [THIS PERIOD] → [THIS TIME] → mm/dd to mm/dd → mm/dd to [CURR.] (current) → [DISP. ALL]...

Note 1: Selecting [THIS PERIOD] will filter the marks to show only marks inserted with one month before or after the current date, regardless of the year.

Note 2: Selecting [THIS TIME] will filter the marks to show only marks inserted with three hours before or after the current time, regardless of the year.

In the above cycle, “mm” means “month”, in 2-digit format, and “dd” means “day” in 2-digit format. For example, July 4 would appear as “07/04”.

You can set the start and end dates you want to use for the filters with the following procedure:

1. Open the menu.
2. Select [MARKS•PLOTTER].
3. Select [MARK].
4. Select [NEXT].
5. Select [MARK FILTERS(DATE)]. The [MARK FILTERS(DATE)] menu appears.
6. Select [START DATE].
7. Spin the scrollwheel to set the year, then left-click. Set the month and day in the same manner.
8. Select [END DATE].
9. Spin the scrollwheel to set the year, then left-click. Set the month and day in the same manner.
10. Close the menu.

MARK FILTERS(DATE)	
1	BACK
2	START DATE 2016/01/01
3	END DATE 2016/01/01

The selected dates appear in the filter settings at the mid-left side of the screen when [DATE] is selected as the filter type.

6.3 Origin Marks

You can enter up to 40 origin marks. When you enter an origin mark, the bearing and range from the cursor location to the mark appears in the [ORIGIN MARK LIST]. This makes origin marks handy for marking reefs and potential hazards.

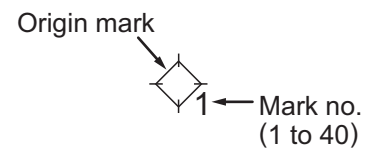

6.3.1 How to set up an origin mark

Setting the mark type and color

Before you enter an origin mark, set the mark type and the color of the origin mark.

1. Open the menu.
2. Select [MARKS•PLOTTER].
3. Select [MARK].
4. Select [MARK SELECT]. The [MARK COLOR/SHAPE] window appears.
5. Select [COLOR].
6. Select the color you want to assign to the origin mark.
7. Select [MARK TYPE].
8. Select [ORIGIN MARK].
The mark shown in the [MARK] box changes to the origin mark.
9. Close the window.

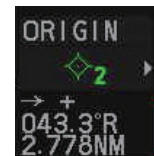

Note: You can also change the mark type directly from the [MARK] box. Place the cursor on the type indication in the [MARK] box, then spin the scrollwheel or left-click to cycle through the options. Changes made in this manner are also reflected on the [MARK COLOR/SHAPE] window.

Origin mark stabilization

You can change the stabilization for the origin mark.

1. Open the menu.
2. Select [MARKS•PLOTTER].
3. Select [MARK].
4. Select [ORIGIN MARK STAB].
5. Select the group of origin marks you want to stabilize. The groups are: [No.01-10], [No.11-20], [No.21-30], [No.31-40].
6. Select [GND] for ground stabilization, or [SEA] for sea stabilization.
 - [GND]: referenced to a fixed geographical location. Marks referenced in this manner appear in green color.
 - [SEA]: referenced to a moving nautical object. Marks referenced in this manner appear in blue color.

Note: [SEA] stabilized marks are automatically removed when the power is turned off.
7. Close the menu.

6.3.2 How to enter an origin mark

Valid heading and position data is required to enter an origin mark.

Note: If the origin mark is not shown on the screen when you enter it, check the following settings:

- [MAIN MENU] → [MARKS•PLOTTER] → [MARK] → [MARK DISPLAY] must be set to [ON].
 - The [MAP] button on the InstantAccess bar™ must be set to [ON].
1. Place the cursor on the [MARK] box at the bottom-left of the screen.
 2. Spin the scrollwheel to select the origin mark number you want to use, then left-click. The [ORIGIN MARK LIST] window and the [INPUT MARK GUIDE] window appear.

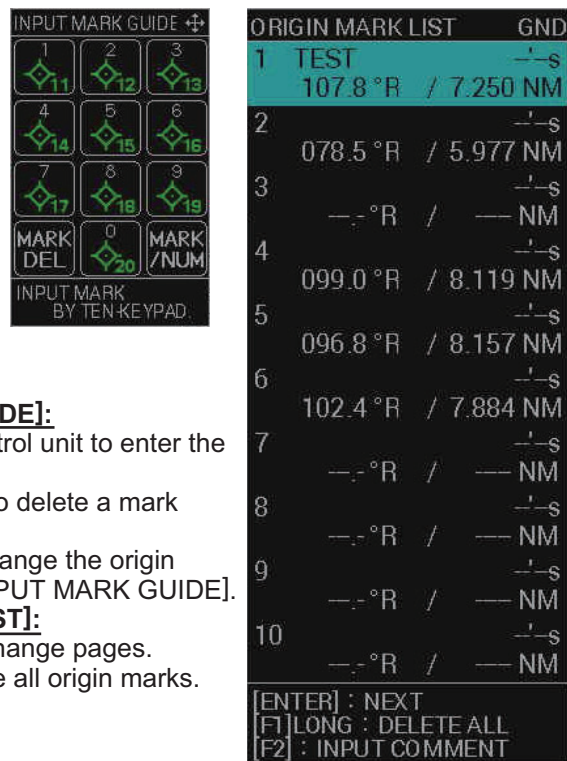

How to use the [INPUT MARK GUIDE]:

- Press the numeric keys on the control unit to enter the corresponding origin mark.
- Press the [CANCEL TRAILS] key to delete a mark highlighted with the cursor.
- Press the **ENTER MARK** key to change the origin mark numbers displayed in the [INPUT MARK GUIDE].

How to use the [ORIGIN MARK LIST]:

- Press the **ENTER MARK** key to change pages.
- Press and hold the **F1** key to delete all origin marks.

Note: Origin mark stabilization reference ("GND"/"SEA") appears at the top-right of the [ORIGIN MARK LIST]. You can change the reference for each group of 10 marks, as outlined in section 6.3.1.

3. Place the cursor on the location you want to mark, then left-click. The selected origin mark appears and the list shows the new mark and the range/bearing to the mark from the cursor. For [SEA] stabilized marks only, the time elapsed since the mark was inserted also appears.
You can also move the origin mark by clicking a different location on the screen.
4. To enter more origin marks, spin the scrollwheel to select the desired origin mark number, then left-click the location you want to enter the mark.
5. Right-click to close the windows and complete the procedure.

6.3.3 How to delete origin marks

There are three methods you can use to delete origin marks.

- **Method 1:** Use the **TARGET CANCEL** key.
 1. Place the cursor on the mark you want to delete, then press the **TARGET CANCEL** key.

When the cursor is placed on a mark, the cursor shape changes as shown in the figure to the right.

 2. Repeat as required.
- **Method 2:** Use the [CURSOR] menu.
 1. Right-click within the radar effective radius to show the [CURSOR] menu.
 2. Select [MARK DELETE].
 3. Place the cursor on the mark you want to delete, then left-click.
 4. Repeat as required.
- **Method 3:** Use the [INPUT MARK GUIDE] window.
 1. Left-click the [MARK] box to show the [INPUT MARK GUIDE] window.
 2. Place the cursor on the mark you want to delete.
 3. Press the **CANCEL TRAILS** key.
 4. Repeat as required.
 5. Right-click to close the window.

6.3.4 How to set a comment for origin marks

You can set a comment for an origin mark with the following procedure.

1. Place the cursor on the [MARK] box at the bottom-left of the screen, then left-click. The cursor changes color, and the [ORIGIN MARK LIST] and [INPUT MARK GUIDE] windows appear.
2. Place the cursor on the mark to which you want to add a comment. The cursor shape changes as shown in the figure to the right.
3. Press **F2**.
4. Referring to section 1.5.3, enter the desired comment. Comments appear in the upper-left section of the mark details in the [ORIGIN MARK LIST].
5. Right-click to complete the procedure and close the windows.

6.4 Waypoints

The term “waypoints” is used to describe points of departure/arrival, turning points and other special points that can be used for navigation. Using waypoint information, you can find the shortest route to your destination.

6.4.1 How to create a waypoint

There are seven methods you can use to registers a waypoint.

- Enter a waypoint at the current own ship’s location.
- Enter a waypoint at the cursor location.
- Enter a waypoint at the location specified latitude/longitude.
- Enter a waypoint at the location specified bearing and distance.
- Enter a waypoint from Loran-C time deviation.
- Enter a waypoint from Loran-A time deviation.
- Enter a waypoint from Decca phase difference.

Note: This feature requires [ROUTE DATA SOURCE] in the [ROUTE•WAYPOINTS] menu to be set to [INTERNAL]. If the setting is [EXTERNAL], the above methods are not available and any waypoints entered previously are not displayed.

Entering a waypoint at your current location

1. Place the cursor on the MOB button on InstantAccess bar™, then left-click. The MOB mark appears at your current location as a GOTO waypoint. This waypoint is automatically assigned the name MOB and appears in the waypoints list. A pop up message appears asking if you want to go to the MOB location.

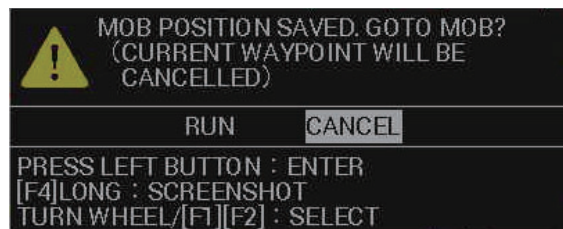

2. **To navigate to the waypoint**, spin the scrollwheel to select [RUN], then left-click. **To keep the waypoint but not navigate to it**, select [CANCEL].

You can also enter a waypoint at your current location if the cursor is hidden. Right-click within the radar effective radius, then select [WPT] from the [CURSOR] menu.

Entering a waypoint at the cursor location

1. Place the cursor on the [WPT MARK] button on the InstantAccess bar™.

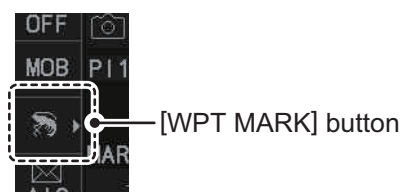

2. Spin the scrollwheel to select the symbol (icon) you want to use for the waypoint.

6. PLOTTER OPERATION (C-TYPES)

3. Left-click the [WPT MARK] button to confirm the selection. The cursor changes color and the guidance box reads "ENTER WPT/EXIT".
4. Place the cursor on the location you want to enter the waypoint, then left-click. The [WAYPOINT ENTRY] window appears.



5. You can now set a name for the waypoint (max. six characters).
Waypoints are assigned the lowest available waypoint number as their name by default. If you want to keep the default, go to step 7. You can move the cursor in the [WAYPOINT ENTRY] window; press **F2** to move right, press **F1** to move left. To reset the name to default, press and hold **F3**.
6. To change the waypoint color, press **F3**. The icon at the [WPT MARK] button changes color with each press.
7. Place the cursor on the location you want to enter the waypoint, then left-click. The selected waypoint appears.

Note 1: If you do the above procedure while the cursor is hidden, the waypoint appears at the own ship location.

Note 2: At step 6, if you assign a name that is already in use, an error message appears.



Select [RUN] to overwrite the existing waypoint, or [CANCEL] to rename the new waypoint. This message only appears when [CONFIRM OVERWRITE] in the [WAYPOINT SETTINGS] menu is set to [ON].

Entering a waypoint at specific coordinates

1. Open the menu.
2. Select [ROUTES•WAYPOINTS].

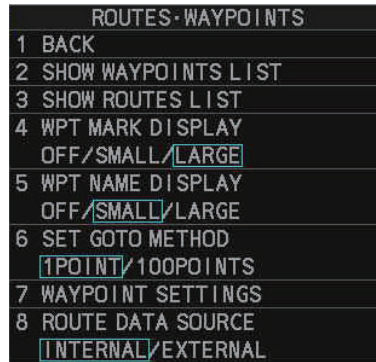

3. Select [SHOW WAYPOINTS LIST]. The [WAYPOINTS LIST] appears.

WAYPOINTS LIST				SEL PAGE	1/1
SET DEST.: WPT 000005					
NAME	LATITUDE/LONGITUDE	INT. BAN	COMMENT		
000001	35° 22.5313'N 139° 41.9326'E	0.00NM	07:48 1706.15		
000002	35° 18.9767'N 139° 41.6503'E	0.00NM	07:49 1706.15		
000003	35° 16.1454'N 139° 43.3975'E	0.00NM	08:11 1706.15		
000004	35° 16.1618'N 139° 43.5014'E	0.00NM	08:11 1706.15		
000005	35° 17.7769'N 139° 45.3305'E	0.00NM	07:55 1706.15		
SORT : ALPHA. ORD		RNG ORDER	EST TIME OF ARR.		
MARK SHAPE		REG. ORDER	6/15 07 : 50		
SPD FOR : T. SHP SPD : 13.4 kn		TIME TO GO			
TTG CALC ENT VALUE : 0 0 . 0 kn		0HR 04MIN			
SEARCH : _____		+			
TURN WHEEL/[F1][F2] : SELECT PRESS RIGHT BUTTON : CLOSE					
PRESS LEFT BUTTON : EDIT DEST.					
[F1]LONG : NEW WPT [F2]LONG : SET DEST.					
[CANCEL] : DELETE DEST. [F3]LONG : DELETE ALL					
[0]-[9]/[F3][F4] : PAGE NO/MOVE PAGE [F4]LONG : SCREENSHOT					

4. Press and hold **F1** to show the [EDIT WAYPOINT NAME] window.

EDIT WAYPOINT NAME			
NAME OF WPT	000013		
LATITUDE	35° 18. 2829' N		
LONGITUDE	139° 43. 8754' E		
MARK COLOR	<input type="checkbox"/> <input checked="" type="checkbox"/> <input type="checkbox"/> <input type="checkbox"/> <input type="checkbox"/> <input type="checkbox"/> <input type="checkbox"/> <input type="checkbox"/>		
MARK SHAPE	<input type="checkbox"/> <input type="checkbox"/> <input type="checkbox"/> <input type="checkbox"/> <input type="checkbox"/> <input type="checkbox"/> <input type="checkbox"/> <input type="checkbox"/> <input type="checkbox"/> <input type="checkbox"/>		
MARK DISPLAY	YES NO		
COORDINATE	LAT./LON. RNG./BRG. TIME DIFF.		
INT. BAN	0. 00 NM		
COMMENT	08:01 1706.15		
RUN			
TURN WHEEL/[F1][F2] : SELECT		PRESS LEFT BUTTON : ENTER	
PRESS RIGHT BUTTON : CLOSE		[F4]LONG : SCREENSHOT	

6. PLOTTER OPERATION (C-TYPES)

5. Select [NAME OF WPT].
6. Referring to section 1.5.3, enter a name for the waypoint.
7. Select [LATITUDE].
8. Spin the scrollwheel to select the desired numeral, then left-click to move the cursor to the next numeral.
9. Set [LONGITUDE] in the same manner.
10. Select [COLOR].
11. Select the color you want to use for this waypoint.
12. Select [SHAPE].
13. Select the shape you want to use for this waypoint.
14. Select [MARK DISPLAY].
15. Depending on your requirements, do one of the following:
 - Select [YES] to show the waypoints on-screen.
 - Select [NO] to hide the waypoints on-screen.
16. Select [INT. BAN].
17. Spin the scrollwheel to set the radius of the intrusion alert area.

The waypoint symbol is replaced with a red colored “” symbol. When a waypoint enters the area, an alert is released. The waypoint also appears in red color in the waypoints list. For how to activate/deactivate this alert, see section 6.7.4.
18. Select [COMMENT].
19. Referring to section 1.5.3, enter a comment for the waypoint.
20. Select [RUN]. The settings are applied to the selected waypoint.

Entering a waypoint with specific bearing/range

1. Open the menu.
2. Select [ROUTES•WAYPOINT].
3. Select [SHOW WAYPOINTS LIST]. The [WAYPOINTS LIST] appears.
4. Press and hold **F1** to show the [EDIT WAYPOINT NAME] window.
5. Select [COORDINATE].
6. Select [RNG./BRG.].

[DISTANCE] and [BEARING] appear here when [RNG./BRG.] is selected at [COORDINATE].

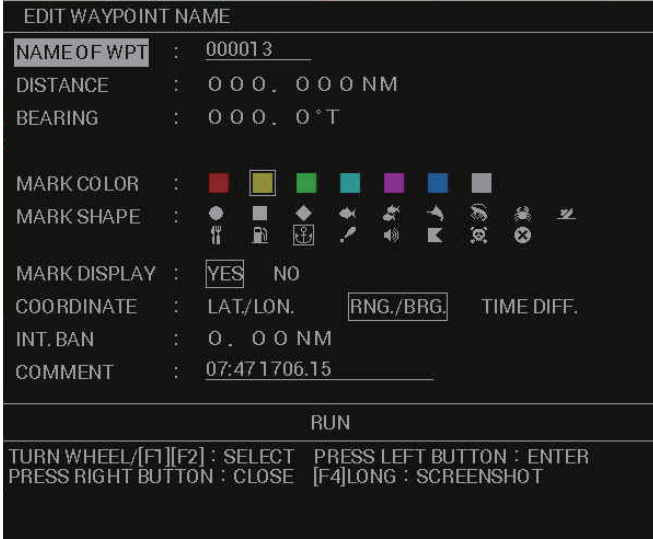

EDIT WAYPOINT NAME			
NAME OF WPT	:	000013	
DISTANCE	:	000.000 NM	
BEARING	:	000.0°T	
MARK COLOR	:	[Red] [Yellow] [Green] [Cyan] [Magenta] [Blue] [Grey]	
MARK SHAPE	:	[Circle] [Square] [Diamond] [Triangle] [Star] [Hexagon] [Octagon] [Cross] [X]	
MARK DISPLAY	:	YES NO	
COORDINATE	:	LAT./LON.	RNG./BRG. TIME DIFF.
INT. BAN	:	0.00 NM	
COMMENT	:	07:47 1706.15	
RUN			
TURN WHEEL/[F1][F2] : SELECT PRESS LEFT BUTTON : ENTER			
PRESS RIGHT BUTTON : CLOSE [F4]LONG : SCREENSHOT			

7. Select [DISTANCE].
8. Enter the distance from Own Ship to the waypoint.
9. Select [BEARING].
10. Enter the bearing from Own Ship to the waypoint.
11. Referring to "Entering a waypoint at specific coordinates" on page 6-41, set the other attributes for the waypoint (name, color, etc).

Entering a waypoint using LORAN A/C

1. Open the menu.
2. Select [INITIAL SETTINGS].
3. Select [LORAN•DECCA].
4. Select [LORAN•DECCA SELECT].
5. Select [LORAN A] or [LORAN C] as required.
6. Select [BACK] twice.
7. Select [ROUTES•WAYPOINTS].
8. Select [SHOW WAYPOINTS LIST]. The [WAYPOINTS LIST] appears.
9. Press and hold **F1** to show the [EDIT WAYPOINT NAME] window.
10. Select [COORDINATES].
11. Select [TIME DIFF.].

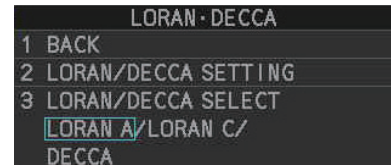

[TIME OFFSET 1]/[TIME OFFSET 2] appear here when [TIME DIFF.] is selected at [COORDINATE]. (Requires [LORAN/DECCA SELECT] in the [LORAN•DECCA] menu to be set as either [LORAN A] or LORAN C.)

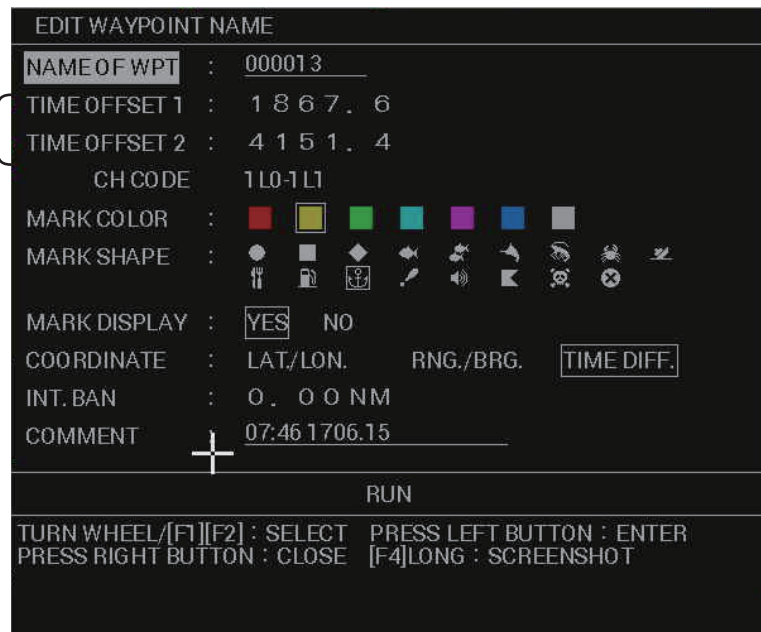

12. Select [TIME OFFSET1].
13. Set the first time offset.
14. Select [TIME OFFSET2].
15. Set the second time offset.
16. Referring to "Entering a waypoint at specific coordinates" on page 6-41, set the other attributes for the waypoint (name, color, etc).

6. PLOTTER OPERATION (C-TYPES)

Entering a waypoint using DECCA

1. Open the menu.
2. Select [INITIAL SETTINGS].
3. Select [LORAN•DECCA].
4. Select [LORAN•DECCA SELECT].
5. Select [DECCA].
6. Select [BACK] twice.
7. Select [ROUTES•WAYPOINTS].
8. Select [SHOW WAYPOINTS LIST]. The [WAYPOINTS LIST] appears.
9. Press and hold **F1** to show the [EDIT WAYPOINT NAME] window.
10. Select [COORDINATES].
11. Select [TIME DIFF.].

[LANE 1]/[LANE 2] appear here when [TIME DIFF.] is selected at [COORDINATE].
(Requires [LORAN/DECCA SELECT] in the [LORAN•DECCA] menu to be set as [DECCA].)

```
EDIT WAYPOINT NAME
NAME OF WPT : 000013
LANE 1      : 2 F : 0 9 . 1 2
LANE 2      : 1 A : 3 0 . 4 9
CHAIN       : 01 S BALTIC R-G
MARK COLOR  : [red] [yellow] [green] [cyan] [magenta] [blue] [grey]
MARK SHAPE  : [circle] [square] [diamond] [fish] [arrow] [spiral] [star] [cross]
              [fork] [fuel] [logo] [hand] [speaker] [back] [skull] [X]
MARK DISPLAY : YES NO
COORDINATE  : LAT./LON. RNG./BRG. TIME DIFF.
INT. BAN    : 0. 0 0 NM
COMMENT     : 07:46 1706.15

RUN

TURN WHEEL/[F1][F2] : SELECT PRESS LEFT BUTTON : ENTER
PRESS RIGHT BUTTON : CLOSE [F4]LONG : SCREENSHOT
```

12. Select [LANE1].
13. Set the first lane offset.
14. Select [LANE2].
15. Set the second lane offset.
16. Referring to "Entering a waypoint at specific coordinates" on page 6-41, set the other attributes for the waypoint (name, color, etc).

6.4.2 How to edit a waypoint

You can edit the waypoint information for all saved waypoints from the waypoints list.

Note: This procedure requires [ROUTE DATA SOURCE] in the [ROUTE•WAYPOINTS] menu to be set to [INTERNAL].

1. Open the menu.
2. Select [ROUTES•WAYPOINTS].
3. Select [SHOW WAYPOINTS LIST]. The [WAYPOINTS LIST] appears.
4. Place the cursor on the waypoint you want to edit, then left-click. the [EDIT WAYPOINT NAME] window appears.

Note 1: You can sort the waypoint list in alphabetical order, by range from own ship, by mark shape, or by order in which they were saved (see section 6.4.4).

Note 2: Mark color and shape for waypoints whose setting for [INT. BAN] is other than [0.00NM] cannot be edited.

Note 3: Mark name, color and shape for MOB waypoints cannot be edited.

Note 4: Changes made to mark attribute from the EDIT WAYPOINT NAME window are applied to all future mark entered at the Own Ship position or cursor location.

5. Edit the waypoint attributes as required.
 6. Select [RUN]. A confirmation window appears.
 7. Select [RUN] again to overwrite the waypoint. Select [CANCEL] to cancel the changes. If you selected [RUN], the window closes automatically.
- Note:** If the waypoint is registered as part of a route, another confirmation window appears. Select the appropriate option.

6.4.3 How to delete a waypoint

You can delete a waypoint either from on the screen, or from the [WAYPOINTS LIST].

Note: This procedure requires [ROUTE DATA SOURCE] in the [ROUTE•WAYPOINTS] menu to be set to [INTERNAL].

Deleting a waypoint on-screen

1. Place the cursor on the waypoint you want to delete.
2. Press the **TARGET CANCEL** key. A confirmation window appears.
3. Select [RUN] to delete the selected waypoint, or select [CANCEL] to keep the waypoint.
If you selected [RUN], the waypoint is deleted from the screen, and is also removed from the [WAYPOINTS LIST].

Deleting a waypoint from the [WAYPOINTS LIST]

1. Open the menu.
2. Select [ROUTES•WAYPOINTS].
3. Select [SHOW WAYPOINTS LIST]. The [WAYPOINTS LIST] appears.
4. Select the waypoint you want to delete, then press the **CANCEL TRAILS** key. A confirmation message appears.
5. Select [RUN] again to delete the waypoint. Select [CANCEL] to keep the waypoint. If you selected [RUN], the window closes automatically.

6.4.4 How to search for a waypoint

You can search for waypoints with one of the following methods:

- Sort the list.
- Search for a waypoint by name.

Sorting the [WAYPOINTS LIST]

1. Open the menu.
2. Select [ROUTES•WAYPOINTS].
3. Select [SHOW WAYPOINTS LIST]. The [WAYPOINTS LIST] appears.
4. Select [SORT].
5. Select the sorting method.
 - [ALPHA. ORD]: sort the list in order of MOB→Numerical→Alphabet.
 - [RNG ORDER]: sort the list in order of range from own vessel.
 - [MARK SHAPE]: sort the list in order of MOB→Intrusion Ban mark→marks in the order in which they appear in the [EDIT WAYPOINT NAME] window.
 - [REG. ORDER]: sort the list from oldest waypoint to newest waypoint.
6. Right-click to close the window.

Searching for waypoints by name

1. Open the menu.
2. Select [ROUTES•WAYPOINTS].
3. Select [SHOW WAYPOINTS LIST]. The [WAYPOINTS LIST] appears.
4. Select [SEARCH]. The software keyboard appears.
5. Referring to section 1.5.3, enter the name you want to search for (max. six characters).
6. Select [CONFIRM]. Waypoints which match your search appear at the top of the list.
7. Right-click to close the window.

6.4.5 How to set the voyage speed for calculations

Voyage calculations such as ETA require a speed value in order to display an estimate. You can set a speed for these calculations either manually, or allow the system to automatically make calculation based on your speed at the time the calculation is made.

1. Open the menu.
2. Select [ROUTES•WAYPOINTS].
3. Select [SHOW WAYPOINTS LIST]. The [WAYPOINTS LIST] appears.
4. Select [SPD FOR TTG CALC].
5. Select the appropriate calculation method.
 - [T.SHP SPD]: calculation are based on your actual speed.
 - [ENT VALUE]: calculations are based on the entered speed.

If you selected [T.SHP SPD], go to step 7.
If you selected [ENT VALUE], go to step 6.
6. Spin the scrollwheel to set the speed.
7. Select the waypoint you want to travel to, from the [WAYPOINTS LIST].
The indications "EST TIME OF ARR." and "TIME TO GO" show the updated estimated time of arrival and time to go.
8. Close the window.

6.4.6 How to view waypoint information

Place the cursor on the waypoint whose information you want to view. A pop up window appears with the waypoint's latitude, longitude and comment.

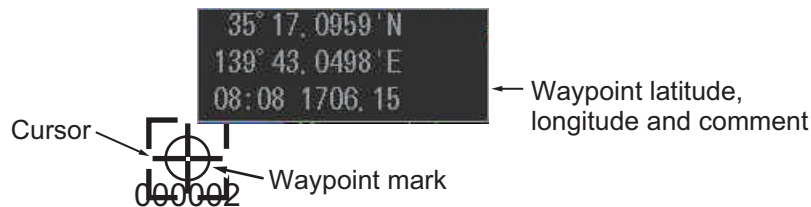

Note: If the pop up information does not appear, check the following menu is set to [ON]: [MAIN MENU] → [ROUTES•WAYPOINTS] → [WPT POP UP INFO.].

6.4.7 How to change the on-screen size of waypoint indications

You can change the size of the waypoint indications to suit your requirements.

1. Open the menu.
2. Select [ROUTES•WAYPOINTS].
3. Select [WPT MARK DISPLAY].
4. Select [OFF], [SMALL] or [LARGE] as required.



[SMALL]



[LARGE]

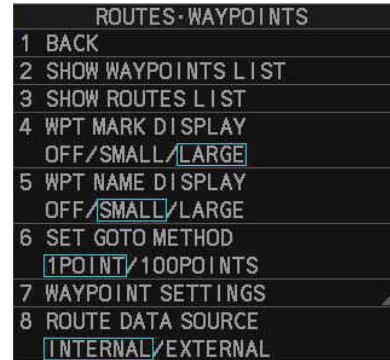

- [LARGE]: Waypoint mark symbols appear in a larger size.
 - [SMALL]: Waypoint mark symbols appear as “x”, regardless of the symbol selected.
 - [OFF]: All waypoints, except active route waypoints and routes, are hidden.
5. Select [WPT NAME DISPLAY].
 6. Select [OFF], [SMALL] or [LARGE] as required.



[OFF]



[SMALL]



[LARGE]

- [LARGE]: Waypoint mark names appear in a larger size.
 - [SMALL]: Waypoint mark names appear in a smaller size.
 - [OFF]: All waypoint mark names are hidden.
7. Close the menu.

6.4.8 How to change the way waypoint names are displayed

By default, waypoints appear with one or more “0”s at the front of their name. You can hide these unnecessary zeros.

1. Open the menu.
2. Select [ROUTES•WAYPOINTS].
3. Select [WAYPOINT SETTINGS].
4. Select [WPT NAME ZERO DISPLAY].
5. Select [HIDE “0”] or [ALL “0”] as required.



[HIDE “0”]



[ALL “0”]

6. Close the menu.

6.4.9 How to use external waypoints

You can show waypoints and routes from a connected GPS navigator on the radar screen. You can also set these external waypoints and routes as destinations from the radar. A total of 100 external waypoints/routes can be stored and displayed at one time.

Note: This feature requires either the WPL sentence or the RTE sentence to be input from the GPS navigator.

1. Open the menu.
2. Select [ROUTES•WAYPOINTS].
3. Select [ROUTE DATA SOURCE].
4. Select the appropriate setting.
 - [INTERNAL]: External waypoints and routes are not used. This is the default setting.
 - [EXTERNAL]: External waypoints appear on the screen and in the [WAYPOINTS LIST]. External waypoint marks are automatically assigned the mark symbol which is selected at the [MARK] button, on the InstantAccess bar™, at the time which the external waypoint was received.
5. Close the menu.

Note: The route data source is automatically changed to [INTERNAL] if a MOB mark is entered. Further, if the data source is changed to [EXTERNAL] while a MOB mark is displayed, the MOB mark is hidden.

6.5 Routes

Often a trip from one place to another involves several course changes, requiring a series of route points (waypoints) which you navigate to, one after another. The sequence of waypoints leading to the ultimate destination is called a route.

6.5.1 How to create a route

You can create a route with one of the three following methods.

- Use existing waypoints.
- Start a route from your current position.
- Use an existing track (own or other ship).

Note: The above methods require [ROUTE DATA SOURCE] in the [ROUTE•WAYPOINTS] menu to be set to [INTERNAL].

Creating a route from existing waypoints

1. Open the menu.
2. Select [ROUTES•WAYPOINTS].
3. Select [SHOW ROUTES LIST]. The [ROUTE LIST] appears.

ROUTES LIST			SEL. PAGE _ 1/1	
NAME	COMMENT	TTL DIST	WPT QTY	SET AS DEST.
000001		13.10NM	4	
BACK TRACK : DIST. TIME		NO	EST TIME OF ARR.	
RNG LOG : 0 0 0 . 1 0 0 NM			6/15 08 : 51	
TIME LOG : 0 0 H 0 1 M			TIME TO GO	
SORT : ALPHA. ORD		RNG ORDER	1 HR 05 MIN	
		REG. ORDER	DIREC : FWD	
SPD FOR : T. SHP SPD : 13.1 kn			+	
TTG CALC ENT VALUE : 0 0 . 0 kn				
SEARCH : _____				
TURN WHEEL/[F1][F2] : SELECT PRESS LEFT BUTTON : EDIT ROUTE				
[ENTER] : NEW WPT [F1]LONG : REVERSE RTE [F2]LONG : SET DEST.				
[CANCEL] : DELETE ROUTE PRESS RIGHT BUTTON : CLOSE				
[0]-[9]/[F3][F4] : PAGE NO/MOVE PAGE [F4]LONG : SCREENSHOT				

4. Press the **ENTER MARK** key. The [ROUTE NAME/ENTER COMMENT] window appears. The system automatically assigns routes a default name (number). To keep the default route name, go to step 7. To change the name, go to step 5.

ROUTE NAME/ENTER COMMENT	
ROUTE NAME	: 000005
COMMENT	: _____
RUN	

5. Select [ROUTE NAME].
6. Referring to section 1.5.3, enter a name for the new route.
7. Select [COMMENT].
8. Referring to section 1.5.3, enter a comment for the new route.

9. Select [RUN]. The [ROUTE TURN POINTS LIST] appears.

000005 ROUTE TURN POINTS LIST				SEL PAGE _ 1/1	
	WPT.	LATITUDE/LONGITUDE	DISTANCE	TTG	
1					
2					
3					
4					
5					
WAYPOINTS LIST				SEL PAGE _ 1/3▶	
NAME		LATITUDE/LONGITUDE	INT. BAN	COMMENT	
000002	🌟	35° 19.3297'N 139° 41.5761'E	0.00NM	07:51 1706.15	
000004	🌟	35° 18.8940'N 139° 42.2283'E	0.00NM	07:51 1706.15	
000005	🌟	35° 15.1021'N 139° 46.7503'E	0.00NM	08:16 1706.15	
000006	🌟	35° 14.6031'N 139° 47.2464'E	0.00NM	08:16 1706.15	
000007	🌟	35° 20.8348'N 139° 41.7893'E	0.00NM	07:46 1706.15	
SORT		: ALPHA. ORD	RNG ORDER		
		MARK SHAPE	REG. ORDER		
SEARCH		: _____	+		
TURN WHEEL/[F1][F2] : SELECT PRESS LEFT BUTTON : WPT LIST					
[F1]LONG : DELETE WPT [F2]LONG : SKIP WPT					
PRESS RIGHT BUTTON : BACK TO ROUTES LIST					
[0]-[9]/[F3][F4] : PAGE NO/MOVE PAGE [F4]LONG : SCREENSHOT					

10. Press the **left button** to move the cursor into the [WAYPOINTS LIST] in the lower half of the window.
11. Select the waypoints you want to use for the new route. Selected waypoints are moved into the upper half of the window.
- Note 1:** Waypoints appear in the sort order selected at the [WAYPOINTS LIST] window. You can re-sort the waypoints from the [ROUTE TURN POINTS LIST].
- Note 2:** If your route has more than six waypoints, the sixth waypoint and onwards appear on the next page(s). Press **F3** or **F4** to change pages.
12. Repeat step 11 as required.
13. Press the **right button** twice to go back to the [ROUTE LIST]. The new route appears in the list.

ROUTES LIST				SEL PAGE _ 1/1	
NAME	COMMENT	TTL DIST	WPT QTY	SET AS DEST.	
000001		13.10NM	4		
00002		6.83NM	4		
BACK TRACK : DIST. TIME			NO	EST TIME OF ARR.	
RNG LOG : 0 0 0 . 1 0 0 NM				6/15 08 : 29	
TIME LOG : 0 0 H 0 1 M				TIME TO GO	
SORT : ALPHA. ORD			RNG ORDER	0HR 40MIN	
			REG. ORDER		
SPD FOR : T. SHP SPD			: 12.7 kn	DIREC : FWD	
TTG CALC			ENT VALUE : 0 0 . 0 kn	+	
SEARCH : _____					
TURN WHEEL/[F1][F2] : SELECT PRESS LEFT BUTTON : EDIT ROUTE					
[ENTER] : NEW WPT [F1]LONG : REVERSE RTE [F2]LONG : SET DEST.					
[CANCEL] : DELETE ROUTE PRESS RIGHT BUTTON : CLOSE					
[0]-[9]/[F3][F4] : PAGE NO/MOVE PAGE [F4]LONG : SCREENSHOT					

The total distance, time to go and ETA for the route also appear in the list.

To use the route for navigation, press and hold the **F2** key.

To navigate the route waypoints in reverse order, press and hold the **F1** key.

14. Close the menu.

Creating a route from your current position

You can create a route by recording a section of your voyage, based either on distance or time. The [BACKTRACK] feature can store a total of 100 waypoints, including waypoints entered manually while recording, to a route in this manner.

While [BACKTRACK] is active, the “save” icon () appears in the upper-right section of the screen.

1. Open the menu.
2. Select [ROUTES•WAYPOINTS].
3. Select [SHOW ROUTES LIST].
4. Select [BACKTRACK].
5. Select the appropriate saving method.
 - [DIST.]: save a preset distance of your voyage as a route.
 - [TIME]: save a preset time (portion) of your voyage as a route.
 - [NO]: deactivate the BACKTRACK feature.
6. Set the time or distance intervals which the [BACKTRACK] feature creates a waypoint automatically.
 - [RNG LOG]: create a waypoint at this distance interval. For example, if setting is [000.100 NM], a waypoint is created every 000.100 NM.
 - [TIME LOG]: create a waypoint at this time interval. For example, if the setting is 00H01M, a waypoint is created every minute.
7. Close the window. Your route is now automatically recorded and waypoints appear on the screen at the set intervals.
8. To add a waypoint manually, do the following:
 - 1) Referring to section 1.7.1, hide the cursor.
 - 2) Right-click within the radar effective radius to show the [CURSOR] menu.
 - 3) Select [WPT]. An pop up message similar to the one shown to the right appears to inform you that a new waypoint was successfully entered.



ADDED WAYPOINT 000003
TO ROUTE 000033
ADDED.

To deactivate the [BACKTRACK] feature, repeat steps 1 to 5 in the above procedure, then select [NO]. The feature is also deactivated automatically when the recorded route reaches 100 waypoints.

Creating a route from existing tracks

You can convert your tracks, or the tracks of other vessels, to routes.

1. Open the menu.
2. Select [MARKS•PLOTTER].
3. Select [TRACK].
4. Select [CONV. TRACK TO RTE]. The [TRACK ROUTE CONVERSION] window appears and track points are shown with small box-shaped icons () at regular intervals along the track.

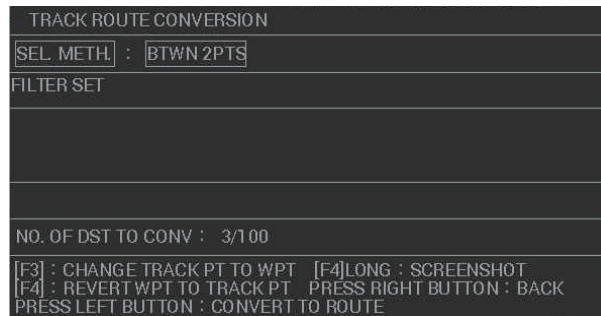

5. Select the track point at which you want to start the conversion.
6. Select the track point at which you want to end the conversion. The [FILTER SET] is now active and you can set the finer details of the conversion.

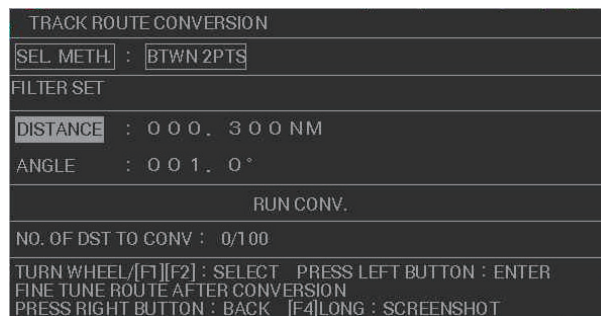

Tracks have a large number of points, you can filter which points will be converted from track points to route points (waypoints). The filter lets you select a distance interval and a bearing difference. Track points that meet both criteria are converted.

7. Select [DISTANCE].
8. Set the distance interval as required.
Only track points at this distance interval are converted to route points (waypoints). Track points which are within the distance range are ignored. For example, if you set [DISTANCE] as [010.00NM], the track points at 10NM intervals, from the start point to the end point, are converted. However, any track points located in between are ignored.
9. Select [ANGLE].
10. Set the bearing minimum.
Only track points which are outside this angle, either to port or starboard, are converted. For example, if you set [ANGLE] as [005.0°], only track points with a bearing of more than 5° from the previous convertible track point are converted.

6. PLOTTER OPERATION (C-TYPES)

11. Select [RUN CONV.]. The number of track points which will be converted appears in the window at [NO. OF DST TO CONV].
You can also remove add or track points from the conversion manually at this point.
To cancel conversion for a point, select the point, then press **F3**.
To add a point for conversion, select the point, then press **F4**.
12. Press the **left button**. A confirmation message appears.
13. Select [RUN] to convert the selected track points to waypoints.
Select [CANCEL] to stop the conversion and go back to the [TRACK ROUTE CONVERSION] window.
If you selected [RUN], the new route appears on the screen and also in the [ROUTES LIST]. The new route is automatically assigned the earliest available route number as a name.

6.5.2 How to edit a route

Note: The following procedures require [ROUTE DATA SOURCE] in the [ROUTE•WAYPOINTS] menu to be set to [INTERNAL].

Inserting a waypoint into an existing route

You can insert waypoint into existing routes with the following procedure.

1. Open the menu.
2. Select [ROUTES•WAYPOINTS].
3. Select [SHOW ROUTES LIST].
4. Select the route to which you want to insert a waypoint. The [ROUTE NAME/ENTER COMMENT] window appears.
5. Select [RUN]. The [ROUTE TURN POINTS LIST] appears.
6. Select the waypoint where you want to insert a new waypoint. The cursor moves to the lower half of the window.
7. Select the waypoint you want to insert. The newly inserted waypoint appears immediately before the waypoint selected at step 6.
Note: If you have incorrectly inserted a waypoint, press the **right button** to go back to the [ROUTE TURN POINTS LIST], select the incorrect waypoint, then press and hold **F1**.
8. Close the menu.

Removing a waypoint from a route

1. Open the menu.
2. Select [ROUTES•WAYPOINTS].
3. Select [SHOW ROUTES LIST].
4. Select the route to which you want to insert a waypoint. The [ROUTE NAME/ENTER COMMENT] window appears.
5. Select [RUN]. The [ROUTE TURN POINTS LIST] appears.
6. Select the waypoint you want to remove, then press and hold **F1**. The selected waypoint is removed from the route.
7. Close the menu.

6.5.3 How to delete a route

Note: The following procedures require [ROUTE DATA SOURCE] in the [ROUTE•WAYPOINTS] menu to be set to [INTERNAL].

1. Open the menu.
2. Select [ROUTES•WAYPOINTS].
3. Select [SHOW ROUTES LIST].
4. Select the route you want to delete, then press the **CANCEL TRAILS** key. A confirmation window appears.

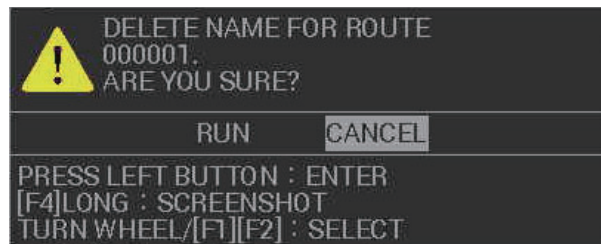

5. Select [RUN] to delete the route, or select [CANCEL] to go back to the [ROUTES LIST].
6. Close the window.

6.5.4 How to search for a route

You can search for a route in the [ROUTES LIST] with one of the two following methods; sort the list, or search by name.

Sorting the [ROUTES LIST]

1. Open the menu.
2. Select [ROUTES•WAYPOINTS].
3. Select [SHOW ROUTES LIST].
4. Select [SORT].
5. Select the sorting method.
 - [ALPHA. ORD]: sort the routes in order of Numerical→Alphabet.
 - [RNG ORDER]: sort the routes in order of total route range (distance).
 - [REG. ORDER]: sort the routes from oldest route to newest route.
6. Right-click to close the window.

Searching for routes by name

1. Open the menu.
2. Select [ROUTES•WAYPOINTS].
3. Select [SHOW ROUTES LIST]. The [ROUTES LIST] appears.
4. Select [SEARCH]. The software keyboard appears.
5. Referring to section 1.5.3, enter the name you want to search for (max. six characters).
6. Select [CONFIRM]. Routes which match your search appear at the top of the list.
7. Right-click to close the window.

6.5.5 How to set the voyage speed for calculations

Voyage calculations such as ETA require a speed value in order to display an estimate. You can set a speed for these calculations either manually, or allow the system to automatically make calculation based on your speed at the time the calculation is made.

1. Open the menu.
2. Select [ROUTES•WAYPOINTS].
3. Select [SHOW ROUTES LIST]. The [ROUTE LIST] appears.
4. Select [SPD FOR TTG CALC].
5. Select the appropriate calculation method.
 - [T.SHP SPD]: calculation are based on your actual speed.
 - [ENT VALUE]: calculations are based on the entered speed.

If you selected [T.SHP SPD], go to step 7.

If you selected [ENT VALUE], go to step 6.

6. Spin the scrollwheel to set the speed.
7. Select the route you want to navigate, from the [ROUTES LIST].
The indications "EST TIME OF ARR." and "TIME TO GO" show the updated estimated time of arrival and time to go.
8. Close the window.

6.5.6 How to use external routes

You can show waypoints and routes from a connected GPS navigator on the radar screen. You can also set these external waypoints and routes as destinations from the radar. A total of 100 external waypoints/routes can be stored and displayed at one time.

Note: This feature requires the RTE sentence to be input from the GPS navigator.

1. Open the menu.
2. Select [ROUTES•WAYPOINTS].
3. Select [ROUTE DATA SOURCE].
4. Select the appropriate setting.
 - [INTERNAL]: External routes are not used. This is the default setting.
 - [EXTERNAL]: External routes appear on the screen and in the [ROUTES LIST].
5. Close the menu.

Note: The route data source is automatically changed to [INTERNAL] if a MOB mark is entered. Further, if the data source is changed to [EXTERNAL] while a MOB mark is displayed, the MOB mark is hidden.

6.6 Destinations

In navigation terminology, a destination point is a particular geographical location on a voyage whether it be a starting, intermediate or destination point. By setting a waypoint, information to get you to the waypoint with the shortest distance and time can be displayed.

6.6.1 How to set up GOTO points

GOTO points are temporary waypoints which are used in quick route functions. GOTO points and quick routes are retained after turning the power off, however old GOTO points and quick routes are replaced when a new GOTO point or quick route is saved.

Setting the GOTO method

The GOTO function can use one of two methods to create a quick route, a single destination, or a series of waypoints.

1. Open the menu.
2. Select [ROUTES•WAYPOINTS].

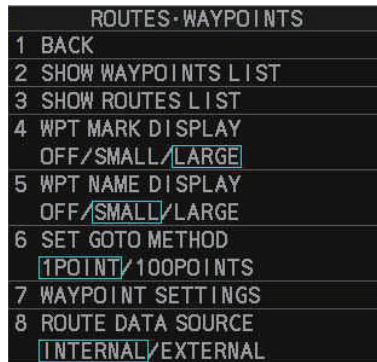

3. Select [SELECT GOTO METHOD].
4. Select the required method.
 - [1POINT]: create a single GOTO point as the destination.
 - [100POINTS]: create up to 100 GOTO waypoints as a quick route.
5. Close the menu.

Setting a single GOTO destination

Note: The following procedure requires [ROUTE DATA SOURCE] in the [ROUTE•WAYPOINTS] menu to be set to [INTERNAL].

1. Set the GOTO method as [1POINT], referring to "Setting the GOTO method" on page 6-57.
2. Do one of the following:
 - For RCU-031 users only: Place the cursor on the location you want to go to, then press the **GOTO** key.
 - Use the cursor menu:
 - 1) Right-click within the radar effective radius to show the [CURSOR] menu.
 - 2) Select [GOTO].
 - 3) Place the cursor on the location you want to go to, then left-click. A GOTO point appears at the selected location, and a route line appears from your current location to the GOTO point, with arrows indicating the direction of travel.

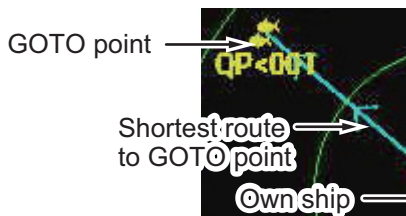

The GOTO points is automatically assigned the name "QP<001". The GOTO point also appears in the [WAYPOINTS LIST].

- Note 1:** If a new single GOTO destination is entered, the old one is deleted.
Note 2: Waypoint data received from a connected navigator is given priority. If a GOTO destination is entered at the navigator, the GOTO point set in the previous procedure is overwritten.

Creating a quick route

Note: The following procedure requires [ROUTE DATA SOURCE] in the [ROUTE•WAYPOINTS] menu to be set to [INTERNAL].

1. Set the GOTO method as 1POINT, referring to "Setting the GOTO method" on page 6-57.
2. Right-click within the radar effective radius to show the [CURSOR] menu.
3. Select [GOTO]. The [CREATE QUICK ROUTE] window appears.



Note: For RCU-031 users, you can also press **GOTO** to open the [CREATE QUICK ROUTE] window.

4. Click an existing waypoint, or new location on the screen, to set the quick route's starting point. If you selected an existing waypoint, the waypoint's name and icon change to yellow color. If you selected a new location, the GOTO point "QP<001" appears.

5. Repeat step 4 as required, leaving the final point unselected.
A route line with arrows indicating the direction of travel appears between each waypoint. You can delete a waypoint immediately after entering it by pressing the **F3** key.
6. At the final waypoint (destination), press the **left button** twice in quick succession (double-click). The quick route is now complete.

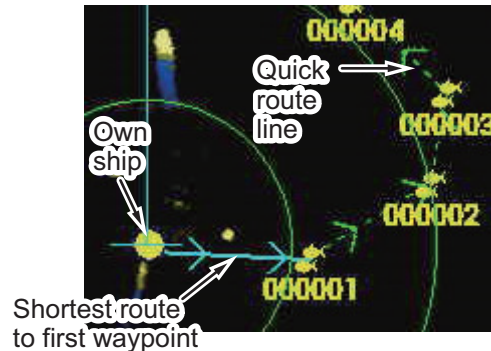

A line indicating the shortest route to the first waypoint appears between your vessel and the first waypoint. The remainder of the quick route is indicated with a green dashed line and arrows showing the direction of travel. The quick route also appears in the ROUTES LIST with the name "Q<RTE".

Note: If a new single quick route is entered, the old one is deleted. Further, if a new GOTO point is entered, the first point of the quick route, "QP<001" is removed from the quick route.

6.6.2 How to set a waypoint as a destination

You can set a waypoint as a destination with one of the following methods:

- Select the waypoint on the screen.
- Select the waypoint from the WAYPOINTS LIST.
- Enter the waypoint number (for waypoints with numeric names only)
- Select the waypoint from the waypoint log.

Note: The above methods require [ROUTE DATA SOURCE] in the [ROUTE•WAYPOINTS] menu to be set to [INTERNAL].

Selecting an on-screen waypoint as the destination

1. Set the GOTO method as [1POINT], referring to "Setting the GOTO method" on page 6-57.
2. Do one of the following:
 - For RCU-031 users only: Place the cursor on the waypoint you want to go to, then press the **GOTO** key.
 - Use the cursor menu:
 - 1) Right-click within the radar effective radius to show the [CURSOR] menu.
 - 2) Select [GOTO].
 - 3) Place the cursor on the waypoint you want to go to, then left-click.

A quick route line appears between your vessel and the selected waypoint.

6. PLOTTER OPERATION (C-TYPES)

Selecting a waypoint from the [WAYPOINTS LIST] as the destination

1. Open the menu.
2. Select [ROUTES•WAYPOINTS].
3. Select [SHOW WAYPOINTS LIST]. The [WAYPOINTS LIST] appears.
4. Select the waypoint you want to set as a destination, then press and hold the **F2** key. The second line of the title bar shows "SET DEST.: WPT xxxxxx" and a quick route to the selected waypoint appears on the screen.
5. Close the window.

Entering the waypoint number as a destination

1. Referring to section 1.7.3, hide the cursor.
2. Right-click within the radar effective radius to show the [CURSOR] menu.
3. Select [GOTO]. The [SELECT WPT] window appears.

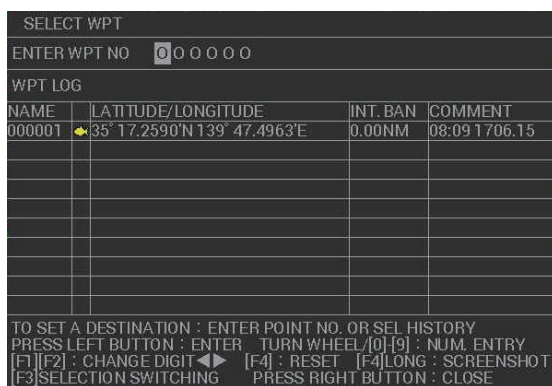

Note: For RCU-031 users, you can also press the **GOTO** key to show the [SELECT WPT] window.

4. Enter the waypoint number for the waypoint you want to set as a destination. Spin the scrollwheel to select a numeral, press **F1** or **F2** to move the input cursor. Press the **left button** to confirm the selection. A quick route line appears on-screen, between your vessel and the selected waypoint.

Selecting a destination from the waypoint log

Up to 10 waypoints, selected previously as a destination, are stored in the waypoint log. You can select a destination from the log. When the log becomes full, the oldest waypoint is removed from the log and the newest waypoint is stored.

1. Referring to section 1.7.3, hide the cursor.
2. Right-click within the radar effective radius to show the [CURSOR] menu.
3. Select [GOTO]. The [SELECT WPT] window appears.
4. Press **F3** to move the cursor into the lower half of the window.
5. Select the waypoint you want to use as a destination. A quick route line appears on-screen, between your vessel and the selected waypoint.

6.6.3 How to set a route as a destination

Selecting the route

Note: This procedure requires [ROUTE DATA SOURCE] in the [ROUTE•WAYPOINTS] menu to be set to [INTERNAL].

1. Open the menu.
2. Select [ROUTES•WAYPOINTS].
3. Select [SHOW ROUTES LIST].
4. Select the route you want to use.
You can change the direction of navigation if required. Press and hold **F1** to toggle between [FWD] (forward) and [REV] (reverse). The navigational direction appears in the bottom-right section of the list.
5. Press and hold **F2** to register the navigational direction to the route. The ROUTES LIST shows the navigational direction in the upper section once registered.

ROUTES LIST				SEL PAGE _ 1/1
NAME	COMMENT	TTL DIST	WPT QTY	SET AS DEST.
Q<RTE		8.27NM	6	
TEST01		5.53NM	4	DST : FW

Navigational direction set to [FWD]

ROUTES LIST				SEL PAGE _ 1/1
NAME	COMMENT	TTL DIST	WPT QTY	SET AS DEST.
Q<RTE		8.27NM	6	
TEST01		5.53NM	4	DST : RV

Navigational direction set to [REV]

6. Close the window.

Skipping waypoints

There are occasions, such as the example shown below, where you may want to skip a waypoint without having to stop and restart navigation. You can skip waypoints with the following procedure.

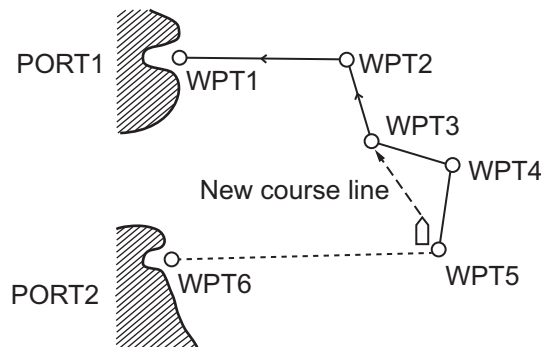

Note: This procedure requires [ROUTE DATA SOURCE] in the [ROUTE•WAYPOINTS] menu to be set to [INTERNAL].

1. Open the menu.
2. Select [ROUTES•WAYPOINTS].
3. Select [SHOW ROUTES LIST].
4. Select the route whose waypoint you want to skip.
5. Select [RUN]. The route details appear in the [ROUTE TURN POINTS LIST].

6. PLOTTER OPERATION (C-TYPES)

- Select the waypoint to skip, then press and hold **F2**. The waypoint and its details appear with asterisks, as shown in the following example.

TEST01 ROUTE TURN POINTS LIST				SEL PAGE _ 1/1	
	WPT.	LATITUDE/LONGITUDE	DISTANCE	TTG	
1	000001	35° 17.2590'N 139° 47.4963'E	0.00NM	00D00H00M	
2	000002	35° 17.8343'N 139° 44.4997'E	2.02NM	08D00H11M	
3	000004	35° 18.1512'N 139° 45.8254'E	***NM	**D**H**M	
4	000003	35° 15.3661'N 139° 49.1018'E	0.00NM	08D00H12M	
5	000005	35° 18.9117'N 139° 47.9295'E	0.00NM	08D00H12M	

WAYPOINTS LIST				SEL PAGE _ 1/3▶	
NAME	LATITUDE/LONGITUDE	INT. BAN	COMMENT		
000001	35° 17.2590'N 139° 47.4963'E	0.00NM	08:09 1706.15		
000002	35° 17.8343'N 139° 44.4997'E	0.00NM	07:56 1706.15		
000003	35° 15.3661'N 139° 49.1018'E	0.00NM	08:09 1706.15		
000004	35° 18.1512'N 139° 45.8254'E	0.00NM	07:56 1706.15		
000005	35° 18.9117'N 139° 47.9295'E	0.00NM	07:56 1706.15		

SORT : ALPHA. ORD RNG ORDER
 MARK SHAPE REG. ORDER
 SEARCH : _____
 TURN WHEEL/[F1][F2] : SELECT PRESS LEFT BUTTON : WPT LIST
 [F1]LONG : DELETE WPT [F2]LONG : SKIP WPT
 PRESS RIGHT BUTTON : BACK TO ROUTES LIST
 [0]/[9]/[F3][F4] : PAGE NO/MOVE PAGE [F4]LONG : SCREENSHOT

You can reactivate the waypoint in the same manner. Select the skipped waypoint, then press and hold **F2**.

- Close the window.

Selecting when to switch waypoints

When navigating a route, you change waypoints each time you arrive at a waypoint. The system has two methods of changing the waypoints:

- [WPT ON VERTICAL LINE]: Waypoints change over as you pass the waypoint, or when the arrival alert is triggered, whichever of the two is earlier.
- [ARRIVAL ALERT RANGE]: Waypoints change at the same time as the arrival alert is triggered.

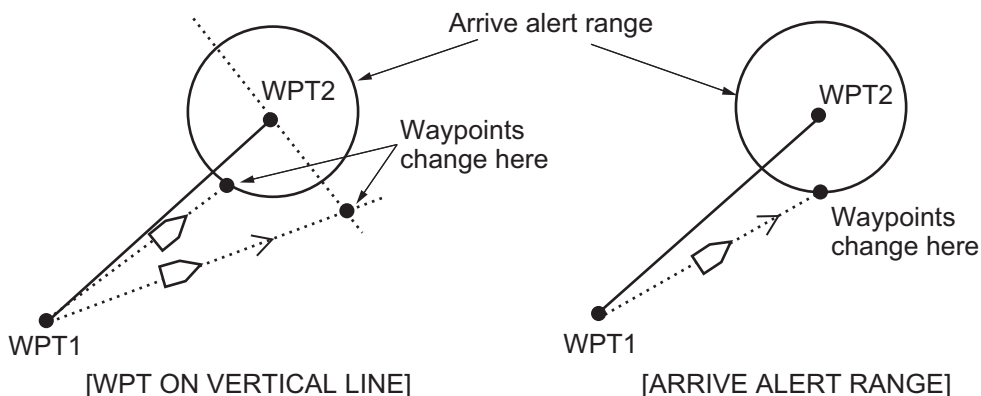

- Open the menu.
- Select [ROUTES•WAYPOINTS].

3. Select [WAYPOINT SETTINGS]. The [WAYPOINT SETTINGS] menu appears.

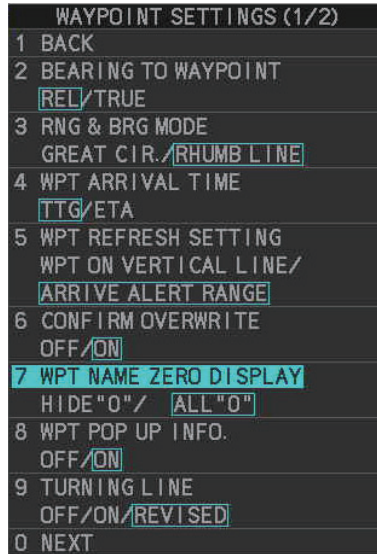

4. Select [WPT REFRESH SETTING].
5. Select [WPT ON VERTICAL LINE] or [ARRIVAL ALERT RANGE] as required.
6. Close the menu.

Setting up the turning line

The turning line indicates the position at which your vessel should turn towards the next waypoint. You can show or hide the line, and also select whether or not to show the line with course offsets.

1. Open the menu.
2. Select [ROUTES•WAYPOINTS].
3. Select [WAYPOINT SETTINGS].
4. Select [TURNING LINE].
5. Select the desired setting.
 - [OFF]: turning line is hidden.
 - [ON]: turning is shown with no offsets.
 - [REVISED]: turning line is shown with offsets, factoring for speed, rate of turn and position after the turn.
6. Select [NEXT] to show the second page of the [WAYPOINT SETTINGS] menu.
7. Select [TURNING LINE SETTING]. The turning line settings appear.
8. Select [SPEED RATE].
9. Set the turn rate (ROT) for low speeds at the top setting.
Set the bottom setting for high speeds.
10. Select [TURN RATE].
11. Set the speed and acceleration rate for low speeds at the top setting.
Set the bottom setting for high speeds.
12. Close the menu.

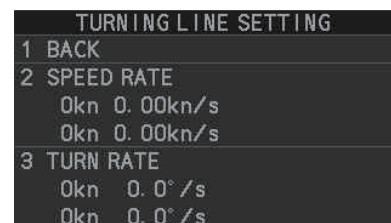

6.6.4 How to set up the waypoint data display

When [WPT DATA] in the [NAV DATA SETTINGS] menu is set at [ON] (see section 1.47.1), waypoint data appears in the information box. You can change how the data appears with the following procedure.

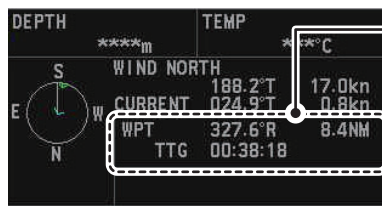

Waypoint data shows:

- Bearing from own ship to WPT
- Range (distance) from own ship to WPT
- Time to go to WPT from current location, or estimated time of arrival (selected from the menu)

1. Open the menu.
 2. Select [ROUTES•WAYPOINTS].
 3. Select [WAYPOINT SETTINGS].
 4. Select [BEARING TO WAYPOINT].
 5. Select [REL] (relative) or [TRUE] as required.
 6. Select [BEARING MODE].
 7. Select the appropriate mode.
 - [GREAT CIR.]: This course line is the shortest course between two points on the surface of the earth, like stretching a piece of string between two points on earth. Frequent bearing changes are required to navigate by this method. For long-range navigation, divide the Great Circle route into several routes, and navigate each route by rhumb Line.
 - [RHUMB LINE]: This method calculates the range and bearing between two points drawn on a nautical chart. Since the bearing is kept constant it is ideal for short-range navigation.
- Note:** The setting selected here is also applied to the overall route distance calculation.
8. Select [WPT ARRIVAL TIME].
 9. Select the appropriate setting.
 - [TTG]: arrival time appears as “time to go” from your current location.
 - [ETA]: arrival time appears as an “estimated time of arrival” at the destination.
 10. Close the menu.

6.6.5 How to stop navigation to a destination

- Do one of the following to stop navigation to the set destination:
 - For RCU-031 users only: Press the **GOTO** key.
 - Use the cursor menu:
 - Right-click within the radar effective radius to show the [CURSOR] menu.
 - Select [GOTO].
 - Place the within the radar effective radius, then left-click. A confirmation message appears.

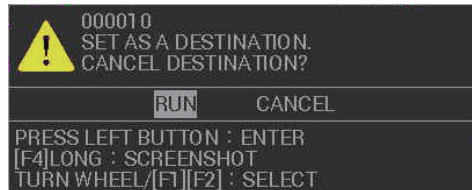

- Select [RUN] to stop navigating to the destination, or select [CANCEL] to continue navigating to the destination. The confirmation window closes automatically when you select an option.

6.7 Plotter-related alerts

6.7.1 How to set waypoint arrival/departure alerts

Setting the arrival alert

The arrival alert informs you that your vessel is approaching a waypoint. The alert area is a circle, with the waypoint at the center. The alert is released if your vessel enters the circle. When the arrival alert is active, a red dashed circle marks the alert range.

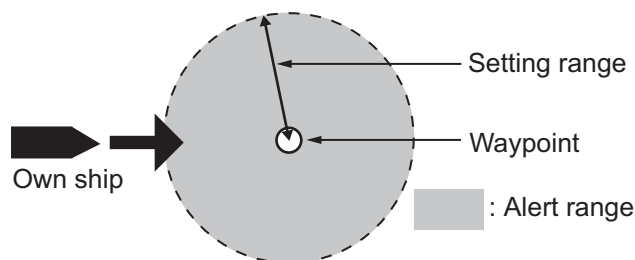

- Open the menu.
- Select [ALERTS].
- Select [ARRIVAL]. The [ARRIVAL] menu appears.
- Select [WPT ARRIVAL ALERT].
- Select [ON] to activate the alert area. The cursor moves to the [ALERT RANGE] setting.
- Set the alert range. This sets the radius for the alert area circle around each waypoint.
- Close the menu.

To deactivate the alert, select [OFF] at step 5 of the above procedure.



Setting the departure alert

The departure alert works informs you when your vessel passes a set distance from the waypoint. When the departure alert is active, an orange dashed circle marks the alert range.

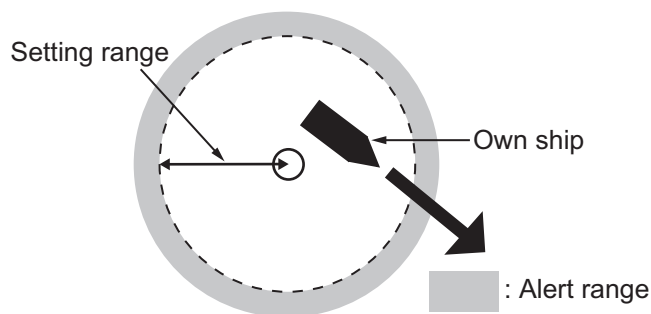

1. Open the menu.
2. Select [ALERTS].
3. Select [ARRIVAL]. The [ARRIVAL] menu appears.
4. Select [WPT ARRIVAL ALERT].
5. Select [ON] to activate the alert area. The cursor moves to the [ALERT RANGE] setting.
6. Set the alert range. This sets the radius for the alert area circle around each waypoint.
7. Close the menu.

To deactivate the alert, select [OFF] at step 5 of the above procedure.

6.7.2 How to set mid-route alerts

You can collectively enable, or disable mid-route alerts such as the arrival and departure alerts.

1. Open the menu.
2. Select [ALERTS].
3. Select [ARRIVAL]. The [ARRIVAL] menu appears.
4. Select [MID ROUTE ALERTS].
5. Select [ON] to enable, or [OFF] to disable the mid-route alerts.
6. Close the menu.

6.7.3 How to set XTE/border route alerts

The XTE (cross-track error) alert informs you when your vessel deviates more than the set distance from the intended route.

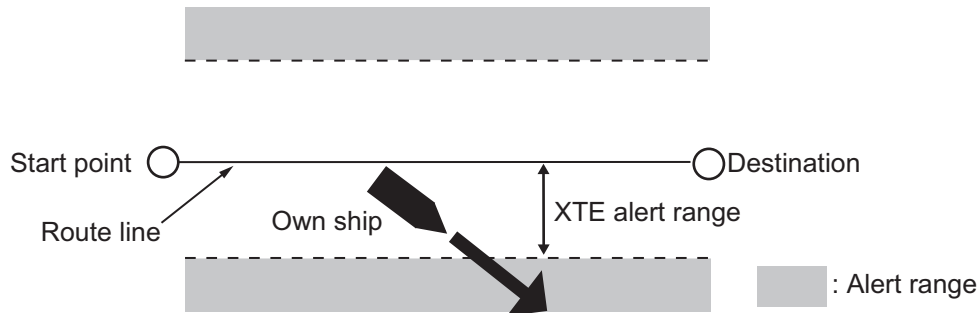

Border alerts use a registered route as a reference line, setting a range to either side of the line as a “border”.

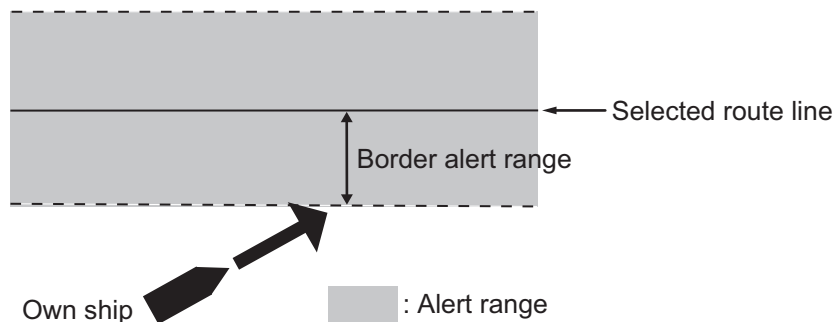

Note 1: You can only activate either the XTE alert or the border alert. Simultaneous use of these alerts is not possible.

Note 2: Both the XTE alert and the border alert are only displayed when you have an active route. If there is no active route, the XTE/border line do not appear on the screen.

1. Open the menu.
2. Select [ALERTS].
3. Select [ARRIVAL]. The [ARRIVAL] menu appears.
4. Select [XTE/BORDER ALERT].
5. Select the appropriate setting.
 - [OFF]: XTE and border alerts are disabled.
 - [BORDER]: use the border alert.
 - [XTE]: use the XTE alert.

When you select either [BORDER] or [XTE], the cursor moves to the [ALERT RANGE] setting.

6. Set the range for the alert.
7. Close the menu.

6.7.4 How to active/deactivate intrusion alerts

Intrusion alerts inform you when you enter a “no-go-zone”, defined by a waypoint with an intrusion alert value of more than [0.00NM] assigned (see section 6.4.1). No-go-zones appear as a red dashed circle around the waypoint when the alert is active.

You can activate the intrusion alert with the following procedure.

1. Open the menu.
2. Select [ALERTS].
3. Select [ARRIVAL]. The [ARRIVAL] menu appears.
4. Select [NO GO ZONE ALERT].
5. Select [ON].
6. Close the menu.

To deactivate the alert, select [OFF] at step 5 of the above procedure.

6.7.5 How to set temperature alerts

Temperature alerts inform when the water temperature is within a specified temperature range, or outside the specified range.

Note: This feature requires water temperature data.

1. Open the menu.
2. Select [ALERTS].
3. Select [W-TMP./TIDE/DEPTH]. The [W-TMP./TIDE/DEPTH] menu appears.
4. Select [WATER TEMP ALERT].
5. Select the appropriate setting.
 - [OFF]: temperature alerts are disabled.
 - [INSIDE]: temperatures which are higher then the setting for [LOWEST TMP] and lower than the setting for [HIGHEST TMP] trigger the alert. All other temperatures are ignored.
 - [OUTSIDE]: temperatures which are lower then the setting for [LOWEST TMP] or higher than the setting for [HIGHEST TMP] trigger the alert. All other temperatures are ignored.
6. Select [LOWEST TMP].
7. Set the temperature to use as the bottom of the range.
8. Select [HIGHEST TMP].
9. Set the temperature to use as the top of the range.
10. Close the menu.

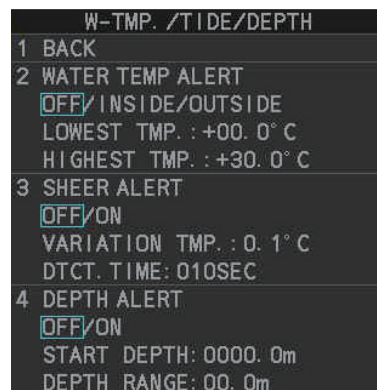

To deactivate the alert, select [OFF] at step 5 of the above procedure.

6.7.6 How to set shear alerts

A shear point is the location where two currents of different temperatures, and in some cases direction, meet. This location is often regarded as a good fishing spot. You can set an alert to inform you when a shear is detected.

Note: This feature requires water temperature data.

1. Open the menu.
2. Select [ALERTS].
3. Select [W-TMP./TIDE/DEPTH].
4. Select [SHEER ALERT].
5. Select [ON]. The cursor moves to the [VARIATION TMP.] setting.
6. Set the change in temperature, then left-click.
When you left-click, the cursor moves to the [DTCT. TIME] setting.
7. Set the detection time, then left-click.

When a change in water temperature is detected that exceeds the values set for [VARIATION TMP.] and [DTCT. TIME], the alert is triggered.

To deactivate the alert, select [OFF] at step 5 of the above procedure.

6.7.7 How to set depth alerts

Depth alerts inform you when the seabed is detected within the set range.

Note: This feature requires depth data.

1. Open the menu.
2. Select [ALERTS].
3. Select [W-TMP./TIDE/DEPTH].
4. Select [DEPTH ALERT].
5. Select [ON]. The cursor moves to the [START DEPTH] setting.
6. Set the starting depth for the alert range, then left-click.
When you left-click, the cursor moves to the [DEPTH RANGE] setting.
7. Set the [DEPTH RANGE], then left-click.

When the detected depth is within the set range, the alert is triggered.

To deactivate the alert, select [OFF] at step 5 of the above procedure.

6.8 Chart Functions

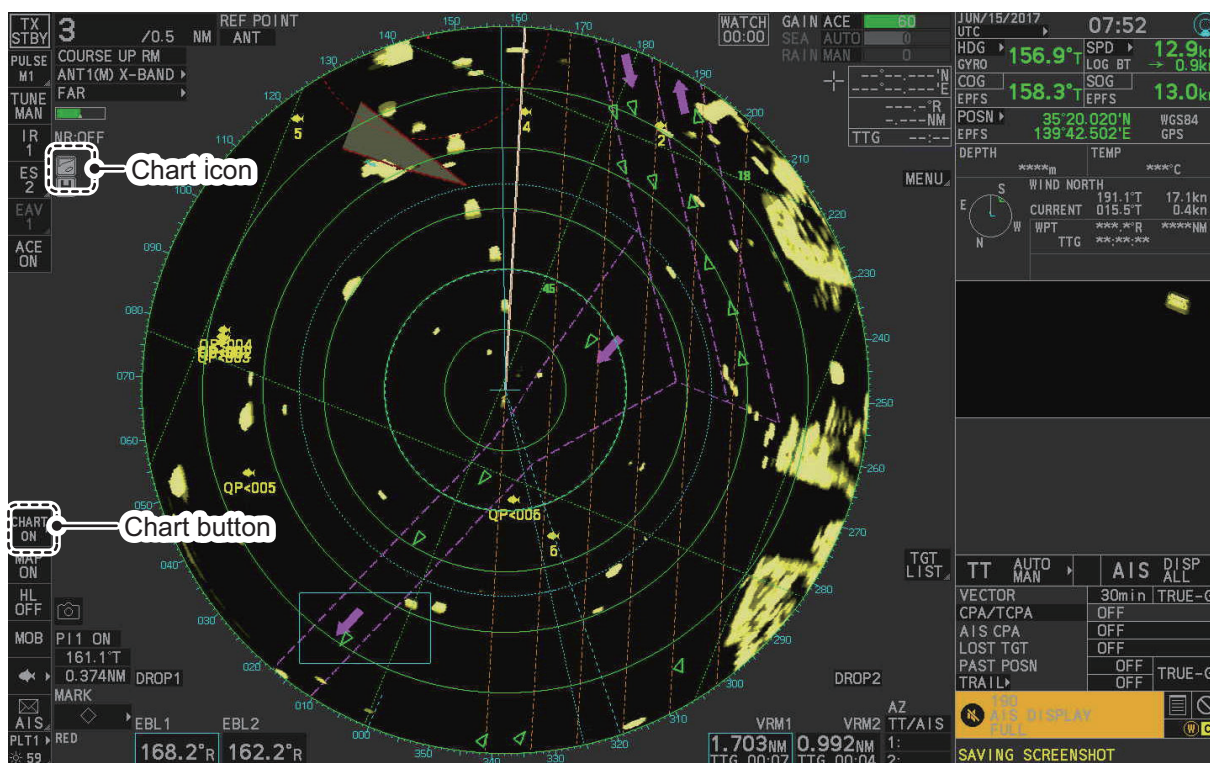

6.8.1 How to show/hide the chart

The [CHART DISPLAY] menu item is [ON] as a factory default. There are two methods to show/hide the chart.

Show/hide the chart using the InstantAccess bar™

Click the Chart button to toggle between [CHART ON] (shows the chart) and [CHART OFF] (hide the chart).



Show/hide the chart from the menu

1. Open the menu.
2. Select [MARKS•PLOTTER].
3. Select [CHART] to show the [CHART] menu.
Note: You can also show the chart by clicking the [CHART] button on the InstantAccess bar™.
4. Select [CHART DISPLAY].
5. Select [ON] to display the chart, or select [OFF] to hide the chart, then left-click.
6. Close the menu.

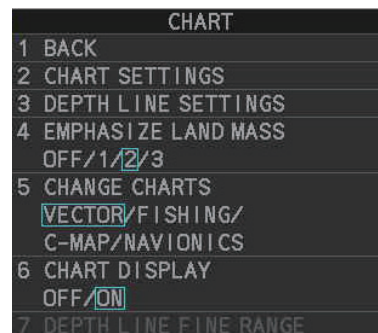





Chart Icons

The chart icon appears at the top-left section of the screen. The icon changes depending on the chart status, as shown below.

Chart Icons	Meaning
	Suitable chart scale.
	Unsuitable chart scale. Press the ZOOM IN or ZOOM OUT key to adjust the chart scale.
	No chart file.

6.8.2 How to align the chart position

When the radar target and the chart are not overlaid correctly, align the chart position.

Note 1: When you activate or deactivate the [MAP ALIGN] function, trails for both own ship and other ships are not reset.

Note 2: Chart alignments are not retained when the radar power is turned off.

1. Right-click the operational display area to show the [CURSOR MENU].
2. Select [MAP ALIGN]. The cursor is now highlighted and the [MAP ALIGN] function is active.
3. Left-click the map at the location you want to move. The map is now “anchored” to the cursor.
4. Move the cursor to align the radar map with the radar screen, then left-click. The indication "MAP ALIGN" appears on the right side of the operational display area.
5. Right-click to deactivate the [MAP ALIGN] function.

Display indications affected by map alignment

The following items are also re-aligned when the [MAP ALIGN] function is activated.

- Map marks
- Drop marks
- Anchor watch settings
- Target tracks
- AIS symbols
- EBL offsets (STAB GND mode only)
- Origin marks
- NAV lines and waypoints
- MOB marks
- Own ship tracks
- Latitude/Longitude Grid
- AIS symbol vector display
- Zoom window display (STAB GND mode only)
- Cursor position coordinates (when CURSOR L/L ALIGN is set to [ON] only)

Display indications unaffected by map alignment

The following items are not re-aligned when the [MAP ALIGN] function is activated.

- Radar echoes
- TT symbol vector display
- PI lines
- Own ship mark
- TT symbols
- EBL/VRM reference point
- OS coordinates ([POSN]) display
- Barge mark

6. PLOTTER OPERATION (C-TYPES)

How to disable the map alignment

1. Right-click the operational display area to show the [CURSOR MENU].
2. Select [MAP ALIGN], then left-click. The cursor is now highlighted and the [MAP ALIGN] function is active.
3. Press and hold the **left button**. The "MAP ALIGN" indication is cleared and the map alignment is cleared.
4. Right-click to deactivate the [MAP ALIGN] function.

6.8.3 How to select the chart type

You can select one of four types of charts, depending on your requirements.

1. Open the menu.
2. Select [MARKS•PLOTTER].
3. Select [NEXT] to show the next page of the menu.
4. Select [CHART].
5. Select [CHANGE CHARTS].
6. Select either of the following charts, then left-click.
[VECTOR]: MapMedia navigational chart.
[FISHING]: MapMedia fishing chart.
[C-MAP]: MapMedia chart based on C-MAP chart data.
[NAVIONICS]: MapMedia chart based on Navionics chart data.
7. Close the menu.

Note: Depth contours for [FISHING] are drawn differently from navigational chart data (bathymetric chart data). The [FISHING] chart does not have the latest shallow information, so select [VECTOR] when sailing into/out of port or sailing along coastlines.

6.8.4 Chart settings menu

Below is the explanation about the each item of [CHART SETTINGS].

1. Open the menu.
2. Select [MARKS•PLOTTER].
3. Select [CHART].
4. Select [CHART SETTINGS].

The [CHART SETTINGS] menu has four pages.



Page 1

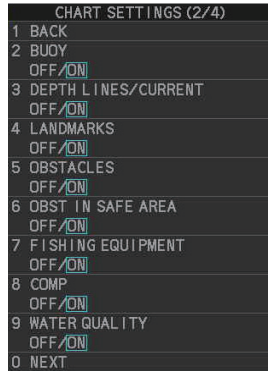

Page 2



Page 3

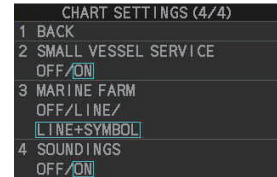

Page 4

5. Select a menu item to change the settings, then left-click.
6. Change the settings, then left-click.
7. Close the menu after changing the settings.

A description for each item is listed below.

[LAND COLOR]: Selects color for land from nine available colors.

[LAND CONTOUR COLOR]: Selects color for edge from 15 available colors.

[BACKGROUND COLOR]: Selects color for background from six available colors. Change the background color when targets and chart lines are hard to see.

[CHARACTER(IMPORTANT)]: Turns important text on or off.

[CHARACTER(OTHER)]: Turns other text on or off.

[PLACE NAME]: Turns geographical name on or off.









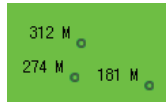

[NAV AIDS]: Turns navigational data display on or off for navigational aids ([LIGHT BEACON] on page 1, through to [SOUNDINGS] on page 4). Each navigational aid can be turned on or off individually. To show the data for a navigational aid, the individual setting must also be set to [ON].

Note: When [NAV AIDS] is set to [OFF], no navigational aid data is displayed, regardless of the individual setting for each navigational aid.

Navigational aid data (see following tables): Turns each mark on or off. To display [MARINE FARM], select [LINE] or [LINE+SYMBOL].



Mark name	Display example	Mark name	Display example	Mark name	Display example
[LIGHT BEACON]		[BUOY]		[DEPTH LINES / CURRENT]	
[LANDMARKS]		[OBSTACLES]		[OBST IN SAFE AREA]	

6. PLOTTER OPERATION (C-TYPES)

Mark name	Display example	Mark name	Display example	Mark name	Display example
[FISHING EQUIPMENT]		[COMP]	Mud	[WATER QUALITY]	
[ALARM AREA]		[MOUNTAIN-TOP]		[LANDSCAPE]	
[FOG SIGNAL]		[SIGNALS]		[SERVICE]	
[HARBOR FACILITIES]		[SMALL VESSEL SERVICE]		[MARINE FARM]	
[SOUNDINGS]					

Note: If the text is displayed with a mark, the text is difficult to see depending on the background.

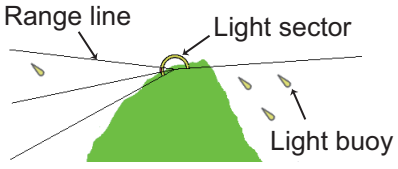
The mark display for light sector differs according to the setting of light beacon. For details, see the table below.

	[LIGHT SECTOR] set to [ON].	[LIGHT SECTOR] set to [OFF].
[LIGHT BEACON] set to [ON].	<p>Light sector and range lines are displayed (lines for range are long).</p> 	<p>Only light sector is displayed (lines for range are short).</p> 
[LIGHT BEACON] set to [OFF].	<p>Light sector and range lines are displayed (range lines are long).</p> 	<p>Light sector is not displayed.</p>

6.8.5 How to show/hide land mass emphasis

[LAND MASS EMPHASIS] sets whether to highlight the outer edge of land masses on the display.

1. Open the menu.
2. Select [MARKS•CHART].
3. Select [CHART].
4. Select [EMPHASIZE LAND MASS].
5. Select [OFF] to disable the emphasis. There are three levels of emphasis available; a higher setting gives a thicker emphasis line around the land mass.
6. Close the menu.

6.8.6 How to set up depth lines

You can turn the depth (bathymetry) lines on/off and select the color/line to use for specified depths.

1. Open the menu.
2. Select [MARKS•PLOTTER].
3. Select [CHART].
4. Select [DEPTH LINES SETTINGS]. The [DEPTH LINES] window appears.

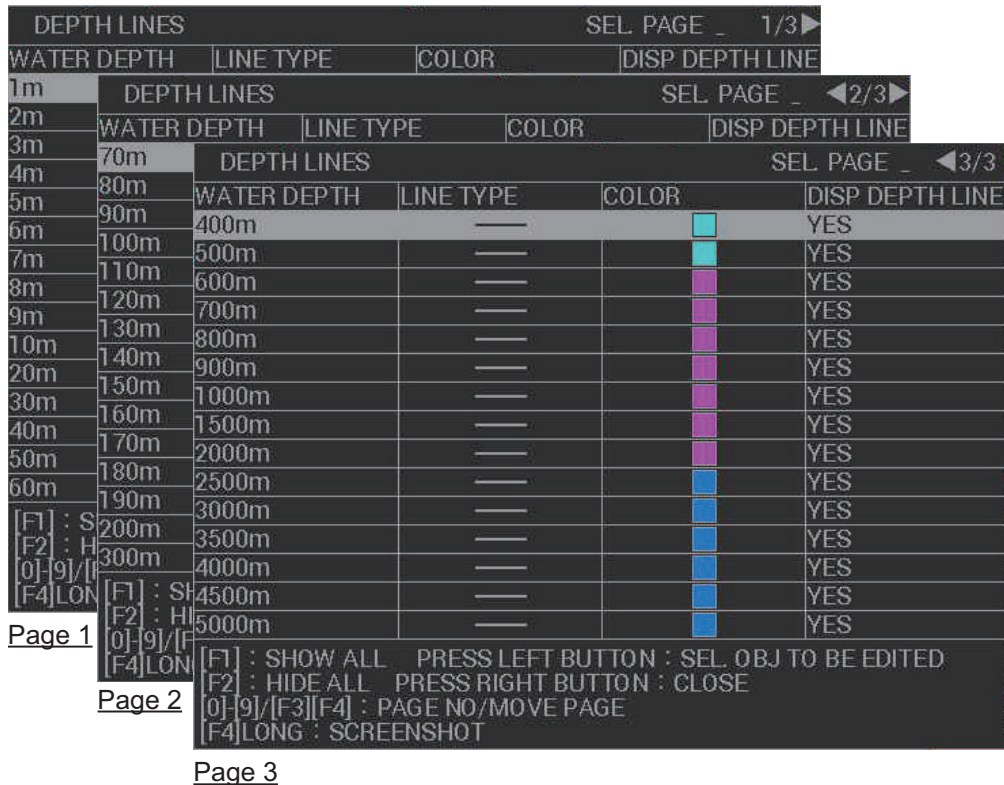

5. Select the depth line you want to set up. The [EDIT DEPTH LINE] window appears.



6. Select [DISP DEPTH LINE].
7. Select [YES] to show the depth line on-screen, or [NO] to hide the depth line.
8. Select [LINE TYPE].
9. Select the type of line to use for the selected depth line.
10. Select [LINE COLOR].
11. Select the color for the selected depth line.
12. Select [RUN] to apply the changes to the selected depth line.
13. Set other depth lines in the same manner, then close the window.

6.8.7 How to display detailed depth lines

Depth lines can appear on the screen with what seems to be an excessively large gap between each line. You can display detailed lines, based on range, to “fill in the blanks”.

1. Open the menu.
2. Select [MARKS•PLOTTER].
3. Select [CHART].
4. Select [DEPTH LINE FINE RANGE]. The [DEPTH LINE FINE RANGE] window appears.
5. Select the depth line at the range you want to show detailed depth lines. The detailed settings window appears.
6. While watching the screen, set the range at which you want to show detailed lines. The lines appear at the selected range on either side of the existing depth line. For example, if the depth line at 3.00NM and you select [+0], no detailed lines appear; however if you select [+1], two detailed lines appear, one at 2.00NM and one at 4.00NM. As you increase the value for this setting, more lines are added to the depths on either side of the selected depth. In other words, the higher the setting, the more lines that appear on-screen. However, with more lines, the chart redraw time increases.
7. Set other ranges in a similar matter.

Note: Depending on the selected display range, some depth lines may not appear on the screen.
8. Close the window.

DEPTH LINE FINE RANGE	
0.025NM	: +0
0.050NM	: +0
0.075NM	: +0
0.100NM	: +0
0.125NM	: +0
0.250NM	: +0
0.500NM	: +0
0.750NM	: +0
1.00NM	: +0
1.50NM	: +0
2.00NM	: +0
3.00NM	: +2
4.00NM	: +0
6.00NM	: +0
8.00NM	: +0
12.00NM	: +0
16.00NM	: +0
24.00NM	: +0
32.00NM	: +0
48.00NM	: +0
96.00NM	: +0
120.0NM	: +0

TURN WHEEL/[F1][F2] : SELECT
 PRESS LEFT BUTTON : ENTER
 PRESS RIGHT BUTTON : BACK
 [F4]LONG : SCREENSHOT



6.8.8 How to check your charts/symbol versions

You can check the version of your charts and symbols from the [CHART ADMINISTRATION] menu.

1. Open the menu.
2. Select [INITIAL SETTINGS].
3. Select [UPDATE CHART]. The confirmation message "OTHER FUNCTIONS WILL STOP DURING THE CHART UPDATE. ARE YOU SURE?" appears.
4. Select [RUN] to access the [CHART ADMINISTRATION] menu.

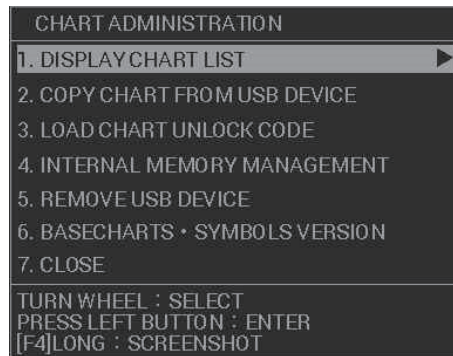

5. Select [BASECHARTS • SYMBOLS VERSION]. The version information for your charts and symbols appears.
6. Right-click to go back to the [CHART ADMINISTRATION] menu.
7. Select [CLOSE]. The confirmation message [CLOSE CHART ADMINISTRATION AND RESTART THE SYSTEM?] appears.
8. Select [RUN]. The system restarts.

6.9 Grid Lines

Grid lines indicate the latitude and longitude. You can show or hide the grid to suit your preference.

1. Open the menu.
2. Select [MARKS•PLOTTER].
3. Select [GRID], then select [ON] to show the grid, or [OFF] to hide the grid.
4. Close the menu.

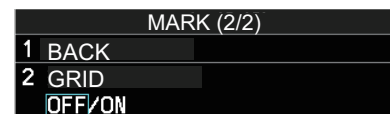

How to change the color of the grid lines

1. Open the menu.
2. Select [2 MARKS•PLOTTER].
3. Select [0 NEXT].
4. Select [3 GRID COLOR].
5. Select the desired color.
6. Close the menu.

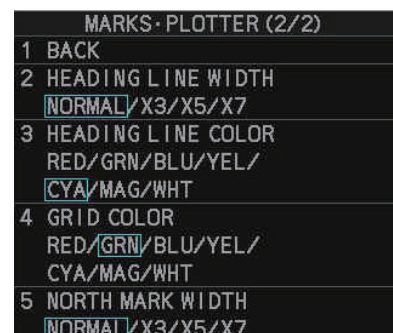

6. PLOTTER OPERATION (C-TYPES)

This page is intentionally left blank.

7. MAINTENANCE, TROUBLE-SHOOTING

Periodic checks and maintenance are important for proper operation of any electronic system. This chapter contains maintenance and troubleshooting instructions to be followed to obtain optimum performance and the longest possible life of the equipment. Before attempting any maintenance or troubleshooting procedure please review the safety information below.

WARNING



Do not open the equipment.

Hazardous voltage which can cause electrical shock exists inside the equipment. Only qualified personnel should work inside the equipment.



Turn off the radar power switch before servicing the antenna unit. Post a warning sign near the switch indicating it should not be turned on while the antenna unit is being serviced.

Prevent the potential risk of being struck by the rotating antenna.



A transmitting radar antenna emits electromagnetic waves, which can be harmful, particularly to the eyes.

Never look directly into the antenna aperture from a close distance while the radar is in operation, or expose yourself to the transmitting radar at a close distance.



Wear a safety belt and hard hat when working on the antenna unit.

Serious injury or death can result if someone falls from the radar antenna mast.

NOTICE

Do not apply paint, anti-corrosive sealant or contact spray to coating or plastic parts of the equipment.

Those items contain organic solvents that can damage coating and plastic parts, especially plastic connectors.

7.1 Periodic Maintenance Schedule

Regular maintenance is essential to good performance. A regular maintenance program should be established and should at least include the items in the table below.

Interval	Check Point	Checks and measures	Remarks
As required	The LCD will in time accumulate a layer of dust which tends to dim the picture	Check that dust or dirt is not on the display. Wipe it carefully to prevent scratching. For difficult to remove dirt or salt deposits, use a cloth made wet with water and neutral detergent (less than 1% detergent). Squeeze the cloth dry then clean the display. When the display is clean, gently wipe the display with a clean, soft, dry cloth, to prevent scratching.	
	Processor unit cleanliness	Dust and dirt may be removed with a soft cloth.	Do not use chemical-based cleaners to clean the processor unit. They can remove paint and markings.
3 to 6 months	Exposed nuts and bolts and sealant compound on cable gland of antenna unit	<ul style="list-style-type: none"> - Check for corroded or loosened nuts and bolts. If necessary, clean and repaint them thickly. Replace them if heavily corroded. - Check for cracks and peeling in sealing compound on cable gland. 	<ul style="list-style-type: none"> - Sealing compound can be used instead of paint. Apply a small amount of grease between nuts and bolts for easy removal in future. - Apply sealing compound to minor crack or peeling. If the problem is severe, completely remove sealant then reapply.
	Antenna radiator	Check for dirt and cracks on radiator surface. Thick dirt should be wiped off with soft cloth dampened with fresh water. If a crack is found, apply a slight amount of sealing compound or adhesive as a temporary remedy, then call for repair.	Do not use chemical-based cleaners for cleaning. They can remove paint and markings. If you need to remove ice from the antenna unit, use a wooden or plastic head hammer. Cracks on the unit may cause water ingress, causing serious damages to internal circuits.
	Terminal strips and plugs in antenna unit (TECHNICIANS only)	Open antenna cover to check terminal strip and plug connections inside. Also check the rubber gasket of antenna covers for deterioration.	When closing antenna covers in position, be careful not to catch loose wires between covers and unit.
6 months to one year	Terminal strips, sockets, earth terminal on processor unit (TECHNICIANS only)	Check for loose connections. Check contacts and plugs for proper seating, etc.	

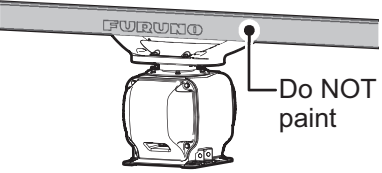
Interval	Check Point	Checks and measures	Remarks
Every year	Antenna Unit	Check the antenna unit for corrosion and paint peeling.	If corrosion or paint peeling is found, paint the affected area. Do not paint the antenna (see below), only paint the scanner. 
5 years	Antenna Unit	If the grease dries out, the V-ring may break, allowing water to leak inside the antenna unit.	Have a qualified technician apply the grease oil to the antenna rotary.

7.2 How to Replace the Fuse

Fuses are located as listed in the tables below. Each fuse protects the equipment from reverse polarity of the ship's mains and equipment fault. If a fuse blows, find the cause before replacing it. Use the correct fuse. Using the wrong fuse will damage the equipment and void the warranty.

 **WARNING**

Use the proper fuse.
Use of the wrong fuse can cause fire or electrical shock.

Note: For monitor units MU-190/MU-231/MU-270W, see the monitor's operator manual for fuse details.

Unit	Fuse type	Code	Remarks
Processor Unit	FGBO-A 250V 7A PBF	000-178-084-10	For AC-powered configurations
	FBGO 125V 20A	000-155-780-10	For DC-powered configurations
	FGBO-A 250V 7A PBF	000-178-084-10	For High Speed Kit only*
Antenna Unit	FGBO-A 250V 3A PBF	000-155-841-10	For Deicer Kit only
Antenna Power Supply Unit	FGBO-A 250V 5A PBF	000-188-540-10	For 100 V AC
	FGBO-A 250V 3A PBF	000-155-841-10	For 220 V AC

*: High Speed Kit is available for S-Band radars only.

7.3 Life Expectancy of Major Parts

This radar has consumable parts, and the table that follows shows the estimated life expectancy for the consumable parts. Request a FURUNO agent or dealer to replace the consumable parts, to get the best performance and longest possible life from the equipment.

Note: The expected lifetimes are typical values. Actual lifetime depends on usage and ambient temperature.

Part	Type	Life expectancy	Remarks
Antenna Unit			
Motor	BV2-K155	10,000 hours	For S-Band radar
	BV2-K156		For X-Band radar (other than FAR-2x58)
	BV2-K159		For X-Band radar (FAR-2x58 only)
Magnetron	FNE1201	5,000 hours	Check number of hours used at TX time.
	MG5436	5,000 hours	
	MG5223F	7,000 hours	
	9M31	2,000 hours	
Monitor Unit			
Bezel & LCD assembly	Refer to the Operator's Manual for the Monitor Unit.		

Note: The magnetron is a consumable item. The effectiveness of your magnetron will decrease over time, causing lower-than-normal signal strength and loss of echoes. Magnetrons should be changed regularly. The table above shows the typical life-span of a magnetron used under normal conditions.

7.4 Trackball Maintenance

If the cursor skips or moves abnormally, clean the trackball using the procedure below.

1. Turn the retaining ring counterclockwise 45° to unlock it.
2. Remove the retaining ring and ball.
3. Clean the ball with a soft, lint-free cloth, then blow carefully into the ball-cage to dislodge dust and lint.
4. Look for a build-up of dirt on the metal rollers. If dirty, clean the rollers using a cotton swab moistened lightly with isopropyl-rubbing alcohol.
5. Make sure that fluff from the swab is not left on the rollers.
6. Replace the ball and retaining ring. Be sure the retaining ring is not inserted reversely.

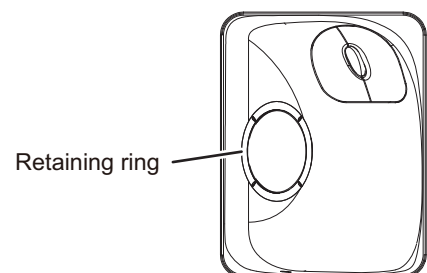

7.5 Easy Troubleshooting

This section provides troubleshooting procedures that the user can follow to restore normal operation. If you cannot restore normal operation, do not attempt to check inside any unit. Any repair work is best left to a qualified technician.

Problem	Possible cause	Remedy
Key beep inaudible.	Key beep turned off.	Adjust key beep level in the [OPERATION] menu, referring to section 1.9.
Picture not updated or picture freeze. 30 seconds after the picture freezes, the buzzer sounds, the ALARM ACK (RCU-014) or ALERT ACK (RCU-031) key blinks and alarm signal is output.	Video freeze.	Turn the power off and on again to restore normal operation.
Power is ON but nothing appears on monitor.	Brilliance is too low.	Adjust the brilliance, referring to section 1.3.
Marks, indications and noise appear but no echo.	Tx high voltage protection circuit has activated.	Reset the power to restore normal operation.
Range changed but radar picture does not change.	Defective range key or video freeze up.	Adjust the range with the control unit, or the [RANGE] box several times. If that does not work try to turn the power off and on again to see if the problem might be video freeze up. If unsuccessful, replacement of keypad may be required.
Only two PI lines when six lines are wanted	Incorrect setting of PI line interval	Adjust PI line interval, referring to section 1.40.3. Also, the setting for number of PI lines to display may be inappropriate. Check the menu setting for number of PI lines, referring to section 1.40.2.
Range rings are not displayed	Range rings are turned off	Try turning on the range rings with [RANGE RING] in the [NAVTOOL] menu. If they do not appear, their brilliance may be too low. Adjust their brilliance in the [BRILL] menu.
Tracked target not tracked correctly	Poor definition of targets in sea clutter	Adjust A/C SEA and A/C RAIN referring to section 1.20 and section 1.21.
Tuning adjusted but poor sensitivity	Second trace echo rejector on or dirt on radiator face	<ul style="list-style-type: none"> • Disable the second trace echo rejector, referring to section 1.29. • Clean the radiator face.

7.6 Advanced-level Troubleshooting

This section describes how to cure hardware and software troubles that should be carried out by qualified service personnel.

Note 1: This radar equipment contains complex modules in which fault diagnosis and repair down to component level are not practicable by users.

Note 2: When replacement of the MAIN board is necessary, the previous settings can be transferred to new MAIN board as follows:

- **For IMO-types**, save your settings to a SD card, referring to section section 1.58.
For C-types, save your settings to a USB Flash memory, referring to section section 1.60.
- After replacing the MAIN board, load the entire contents of the SD card to the radar, referring to section section 1.58 for the procedure.

Problem	Possible cause	Remedy
Cannot turn power on.	1) Blown fuse. 2) Mains voltage/polarity. 3) Power supply board (PWR1 and/or PWR2) inside the Processor unit.	1) Replace blown fuse. 2) Correct wiring and input voltage. 3) Replace the faulty power supply board.
Brilliance adjusted but no picture.	MAIN board - inside the Processor unit.	Replace MAIN board.
Antenna not rotating.	1) Antenna drive mechanism 2) MTR-DRV board	1) Replace antenna drive mechanism. 2) Replace the MTR-DRV board.
Data and marks not displayed in Transmit status	MAIN board - inside the Processor unit.	Replace MAIN board.
Adjust GAIN with A/C SEA set at minimum. Marks and indications appear but no noise or echo.	1) IF amplifier 2) Signal cable between antenna and processor unit	1) Replace IF amplifier. 2) Check continuity and isolation of coaxial cable. Note: Disconnect the plug and lugs at both ends of coaxial cable before checking it by ohmmeter.
Marks, indications and noise appear but no echo (transmission leak representing own ship position is absent)	1) TX high voltage protection circuit has activated. 2) Magnetron 3) MD board inside the antenna. 4) SPU board inside the antenna.	1) Reset power to restore normal operation. 2) Check magnetron current. Replace magnetron. 3) Replace MD board. 4) Replace SPU board.
Picture not updated or picture freeze-up	1) Rotary Encoder inside the antenna unit. 2) SPU board inside the antenna. 3) Video freeze-up	1) Check the connection of signal cables. 2) Replace SPU board. 3) Turn the radar off, then on.
Cannot operate radar from on-screen boxes	MAIN board - inside the Processor unit.	Replace MAIN board.

Problem	Possible cause	Remedy
Incorrect orientation of picture	<ol style="list-style-type: none"> 1) Rotary Encoder inside the antenna unit 2) SPU board inside the antenna unit. 3) MTR-DRV board inside the antenna unit. 	If the message "NO HEADLINE SIGNAL" appears in orange letters inside the alert box, the heading signal is lost or interrupted. Check the heading line signal cable and board connections. If there is no problem with cables or connections, replace the faulty board.
Radar is properly tuned but poor sensitivity	<ol style="list-style-type: none"> 1) Deteriorated magnetron 2) Detuned MIC 3) Dirt on radiator face 4) Water ingress to the waveguide or other feeder line 5) Second trace echo rejection is ON 	<ol style="list-style-type: none"> 1) With the radar transmitting on 48 nm range, check magnetron current. If current is below normal, magnetron may be defective. Replace it. 2) Check MIC detecting current. If it is below normal value, MIC may have become detuned. MIC must be tuned. 3) Clean the radiator surface. 4) Remove water from the feeder line. 5) Disable the second-trace echo rejector referring to section 1.29.
Range changed but radar picture not changing	<ol style="list-style-type: none"> 1) Defective range key 2) SPU board inside the antenna. 3) Video freeze up 	<ol style="list-style-type: none"> 1) Adjust the range with the control unit, or the [RANGE] box several times. If unsuccessful, replacement of keypad may be required. 2) Replace SPU board. 3) Turn off and on radar.
Interference rejector is inoperative (interference rejection level not displayed)	SPU board inside the antenna.	Replace SPU board.
Echo stretch is ineffective (neither ES1, ES2 nor ES3 is displayed)	SPU board inside the antenna.	Replace SPU board.
Range rings are not displayed	<ol style="list-style-type: none"> 1) Adjust the brilliance of range rings on the BRILL menu to see if intensity is increased 2) MAIN board 	<ol style="list-style-type: none"> 1) Replace associated circuit board if unsuccessful. 2) Replace MAIN board.
Poor discrimination in range	Sea clutter control not functioning properly	Improper setting of A/C SEA. If A/C SEA is seen only at very close range, suspect inaccurate frequency of reference oscillator.
True motion orientation not working correctly	<ol style="list-style-type: none"> 1) Incorrect menu setting 2) Speed entry incorrect 3) TM display inaccurate 	<ol style="list-style-type: none"> 1) Referring to section 1.30, select TM orientation mode. 2) Enter correct own ship speed referring to section 1.11. 3) Make sure that speed and compass inputs are accurate.
Target not tracked correctly	Poor definition of targets in sea clutter	Adjust A/C SEA and A/C RAIN referring to section 1.20 and section 1.21.
Buttons on trackball module operated but no response	Trackball module	Replace trackball module.
Picture is not updated with each sweep.	Motor/gears	Check the motor and gears. Replace if worn.

7.7 Diagnostics

A diagnostic test program is provided to test major circuit boards in the control unit, processor unit and card I/F unit. Note that the normal radar picture is lost during this test.

Proceed as follows to execute the diagnostic test:

1. Open the [MAIN MENU].
2. Select [9 INITIAL SETTINGS].
3. Select [7 TESTS].
4. Select [2 DIAGNOSTIC TEST]. The system begins a diagnostic test. The Processor Unit is tested first and the test results appear after a few moments.

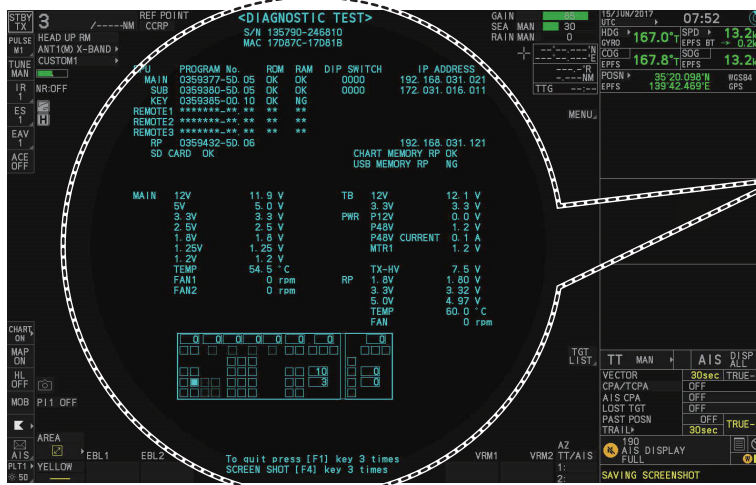

You can save a screenshot to a SD Card if there is a SC Card inserted into the Processor Unit. Press the **F4** key three times to save a screenshot. A keyboard test is available at the bottom of the test results, also. Press each key on the control unit to highlight the corresponding area on-screen. Press the same key again to remove the highlight.

5. Press the **F1** key three times to show the results for antenna test.

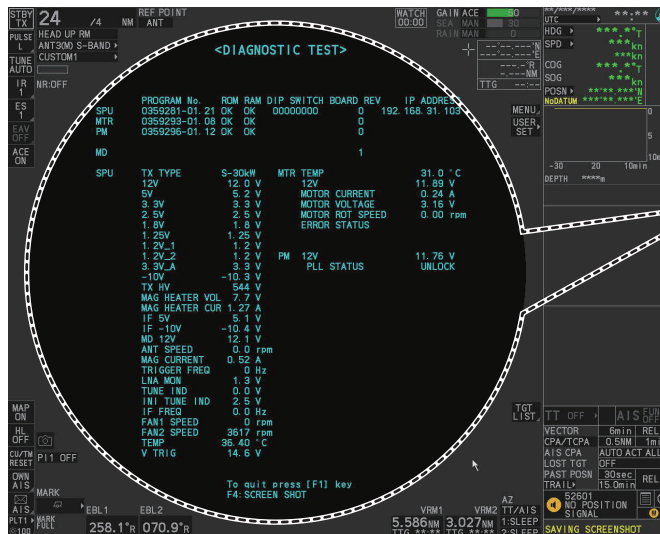

You can save a screenshot to a SD Card if there is a SD Card inserted into the Processor Unit. Press the **F4** key three times to save a screenshot.

6. Press the **F1** key to close the test results and complete the test.

Diagnostic test results

The following table lists each test result along with the normal value range for each item.

"OK" appears for normal operation. If "NG" (No Good) appears, corresponding components may be defective.

Also, if a connected fan or PCB shows the check results as asterisks, it is an indication that the fan or PCB has failed, or is disconnected.

If there are any component which are suspected to be defective, or any test does not complete satisfactorily, consult your dealer for advice.

Tested item		Normal value or Description	
		Magnetron Radar	Solid State Radar
MAIN (Processor Unit) test			
[PROGRAM No.]		Shows the program version number.	
[ROM]		OK	
[RAM]		OK	
[DIP SWITCH]		Shows the DIP SWITCH settings.	
[IP ADDRESS]		Shows the IP address for the Processor Unit.	
[SD CARD]		OK	
[SD CARD RP]		(Not currently used)	
[HSC]		Shown only for systems with the optional High Speed Conversion kit.	
[RMS]		Shown only when Remote Maintenance Service is enabled.	
[MAIN]	[12V]	10.8 to 13.2 V	
	[5V]	4.7 to 5.3 V	
	[3.3V]	3.0 to 3.6 V	
	[2.5V]	2.3 to 2.7 V	
	[1.8V]	1.6 to 2.0 V	
[MAIN]	[1.25V]	1.13 to 1.38 V	
	[1.2V]	1.0 to 1.3 V	
	[TEMP]	-15 to +70°C	
	[FAN1]	3700 to 5700 rpm	
	[FAN2]	3700 to 5700 rpm	
	[FAN3]	<ul style="list-style-type: none"> • X/S-Band radars with 24 rpm config: Not shown • S-Band radars with 42 rpm (HSC) config: 3700 to 5700 rpm 	
[TB]	[12V]	10.8 to 13.2 V	
	[3.3V]	3.0 to 3.6 V	
[PWR]	[P12V]	10.8 to 13.2 V	
	[P48V]	46 to 50 V	
	[P48 V CURRENT]	0 to 3 A	
	[MTR1]	45.1 to 51.3 V	
	[MTR2]	<ul style="list-style-type: none"> • X/S-Band radars with 24 rpm config: Not shown • S-Band radars with 42 rpm (HSC) config: 45.1 to 51.3 V 	
	[TX HV]	500 to 570 V	
RP Board (For A/B-types with Radar Plotter functionality only)			
[PROGRAM No.]		Shows the program version number.	
[IP ADDRESS]		Shows the IP address of the RP board.	
<i>(Continued on following page)</i>			

7. MAINTENANCE, TROUBLESHOOTING

Tested item		Normal value or Description	
		Magnetron Radar	Solid State Radar
<i>(Continued from previous page)</i>			
[CHART MEMORY RP]		OK	
[USB MEMORY RP]		OK	
RP	[1.8V]	1.6 to 2.0 V	
	[3.3V]	3.0 to 3.6 V	
	[5.0V]	4.7 to 5.3 V	
	[TEMP]	-15 to +90°C	
	[FAN]	3700 to 5700 rpm	
SPU (Antenna)			
[PROGRAM No.]		Shows the program version number.	
[ROM]		OK	
[RAM]		OK	
[DIP SWITCH]		Shows the DIP SWITCH settings.	
[BOARD REV]		Shows the revision number for each PCB.	
[IP ADDRESS]		Shows the IP address for the Processor Unit.	
[SPU] (Other than FAR-2x58)	[TX TYPE]	X-12kW/X-25kW/S-30kW/S-50kW	S-Solid
	[12V]	11.4 to 12.6 V	
	[5V]	4.75 to 5.25 V	
	[3.3V]	3.18 to 3.42 V	
	[2.5V]	2.4 to 2.6 V	
	[1.8V]	1.71 to 1.89 V	
	[1.25V]	1.19 to 1.31 V	
	[1.2V_1]	1.14 to 1.26 V	
	[1.2V_2]	1.14 to 1.26 V	
	[3.3V_A]	3.18 to 3.42 V	
	[-10V]	-10.5 to -9.5 V	"not connect"
	[TX HV]	500 to 560 V	"not connect"
	[MAG HEATER VOL]	<ul style="list-style-type: none"> • X-Band, 12 kW: 8.1 to 8.6 V or 6.8 to 7.3 V • X-Band, 24 kW: 7.0 to 7.5 V or 5.7 to 6.2 V • S-Band: 7.4 to 7.9 V or 6.3 to 6.8 V 	"not connect"
	[MAG HEATER CUR]	<ul style="list-style-type: none"> • X-Band: 0.5 to 0.6 A • S-Band: 1.1 to 1.4 A 	"not connect"
	[IF 5V]	4.75 to 5.25 V	"not connect"
	[IF -10V]	-10.5 to -9.5 V	"not connect"
	[MD 12V]	11.4 to 12.6 V	"not connect"
	[ANT SPEED]	<ul style="list-style-type: none"> • 24 rpm antennas: 22 to 26 rpm • 42 rpm antennas: 40 to 44 rpm 	
[MAG CURRENT]	<ul style="list-style-type: none"> • X-Band: 5.0 to 12.0 • S-Band: 6.0 to 10.0 	"not connect"	
<i>(Continued on following page)</i>			

Tested item		Normal value or Description	
		Magnetron Radar	Solid State Radar
<i>(Continued from previous page)</i>			
[SPU] (Other than FAR-2x58)	[TRIGGER FREQ]	<ul style="list-style-type: none"> • STBY: 0 Hz • [2ND ECHO REJ]=[OFF], TT range*= 24NM: S1: 2640 to 3360 Hz, S2: 2640 to 3360 Hz, M1: 1320 to 1680 Hz, M2: 1060 to 1340 Hz, M3: 880 to 1120 Hz, L: 530 to 670 Hz • [2ND ECHO REJ]=[OFF], TT range*= 32NM: S1: 1940 to 2460 Hz, S2: 1940 to 2460 Hz, M1: 1320 to 1680 Hz, M2: 1060 to 1340 Hz, M3: 880 to 1120 Hz, L: 530-670 • [2ND ECHO REJ]=[ON]: S1: 2640 to 3360 Hz, S2: 2640 to 3360 Hz, M1: 440 to 560 Hz, M2: 440 to 560, M3: 440 to 560 Hz, L: 440 to 560 Hz <p style="margin-left: 20px;">*: Maximum TT range is set at installation.</p>	
	[LNA MON]	0.5 to 1.5 V	not connect
	[TUNE IND]	2.0 to 3.0 V	not connect
	[INI TUNE IND]	2.0 to 3.0 V	not connect
	[IF FREQ]	<ul style="list-style-type: none"> • Pulse length = [S1], [S2]: 0.0 Hz • Pulse length = [S1], [S2]: 55.0 to 65.0 Hz 	not connect
	[FAN1 SPEED]	3000 to 5000 rpm	not connect
	[FAN2 SPEED]	3000 to 5000 rpm	not connect
	[TEMP]	-15 to +85°C	
	[V TRIG]	10.0 to 18.0 V	not connect
[SPU] (FAR-2x58 only)	[TX TYPE]	X-50kW	-
	[12V]	12.2 to 13.2 V	-
	[5V]	4.75 to 5.25 V	-
	[3.3V]	3.18 to 3.42 V	-
	[2.5V]	2.4 to 2.6 V	-
	[1.8V]	1.71 to 1.89 V	-
	[1.25V]	1.19 to 1.31 V	-
	[1.2V]	1.15 to 1.25 V	-
	[3.3V_A]	3.18 to 3.42 V	-
	[-12V]	-13.2 to -11 V	-
	[-5V]	-5.25 to -4.75 V	-
	[TEMP]	-15 to +85 °C	-
[PSU-TB] (FAR-2x58 only)	[12V]	9 to 15 V	-
	[-12V]	-15 to -9 V	-
	[HEATER H]	9 to 15 V	-
	[5V]	4.5 to 5.5 V	-
	[-5V]	-5.5 to -4.5 V	-
	[TX HV]*	760 to 820 V	-
*: Shown only while radar is transmitting.			
[PSU] (FAR-2x58 only)	[FAN SPEED]	2400 to 3900 rpm	-
<i>(Continued on following page)</i>			

7. MAINTENANCE, TROUBLESHOOTING

Tested item		Normal value or Description	
		Magnetron Radar	Solid State Radar
<i>(Continued from previous page)</i>			
[MTR]	[TEMP]	Other than FAR-2x58: Ambient Temperature: less than +20 °C FAR-2x58: -25 to +85°C	
	[12V]	9 to 15 V	
	[MOTOR CURRENT]	<ul style="list-style-type: none"> • X-Band (Other than FAR-2x58), 24 rpm: 0.8 A • X-Band (Other than FAR-2x58), 42 rpm: 1.2 A • X-Band (FAR-2x58 only): 0.5 to 1.5 A • S-Band, 24 rpm: 1.3 A • S-Band, 42 rpm: 2 A 	<ul style="list-style-type: none"> • 24 rpm: 1.3 A • 42 rpm: 2 A
	[MOTOR VOLTAGE]	43 to 53 V (antenna units installed on the foremast: 33 to 53 V)	
	[MOTOR ROT SPEED]	Other than FAR-2x58: 0 (STBY)/24/36/42 FAR-2x58: 0 (STBY)/24	
	[ERROR STATUS]	Blank indicates no errors. When an error is found, the relevant binary error code appears.	
[PM]	[12V]	9 to 15 Volts	
	[PLL STATUS]	Other than FAR-2x58: For X-Band (with board revision number 1 or earlier) and S-Band (with board revision number 0): UNLOCK For X-Band (with board revision number 2 or later) and S-Band (with board revision number 1 or later): <ul style="list-style-type: none"> • PM activated: LOCK • PM inactive: UNLOCK FAR-2x58: <ul style="list-style-type: none"> • PM activated: LOCK • PM inactive: UNLOCK 	<ul style="list-style-type: none"> • PM activated: LOCK • PM inactive: UNLOCK
RSB (FAR-2x58 only)	[PFN HV]*	1200 to 1600 V	-
	*: Shown only while radar is transmitting.		
	[ANT SPEED]	20 to 26 rpm	-
	[MAG CURRENT]	3.5 to 10 A	-
	[TRIGGER FREQ]	<ul style="list-style-type: none"> • STBY: 0 Hz • [2ND ECHO REJ]=[OFF]: S: 1425 to 2090 Hz, M1: 825 to 1210 Hz, M2: 450 to 660 Hz, L: 450 to 660 Hz • [2ND ECHO REJ]=[OFF], TT range*= 48NM: S: 825 to 1210 Hz, M1: 825 to 1210 Hz, M2: 450 to 660 Hz, M2: 450 to 660 Hz • [2ND ECHO REJ]=[ON]: S: 1125 to 1650 Hz, M1: 375 to 550 Hz, M2: 375 to 550 Hz, L: 375 to 550 Hz *: Maximum TT range is set at installation.	
[LNA MON]	0.5 to 1.5 V	-	
<i>(Continued on following page)</i>			

Tested item	Normal value or Description		
	Magnetron Radar	Solid State Radar	
<i>(Continued from previous page)</i>			
RSB (FAR- 2x58 on- ly)	[TUNE IND]	Pulse length = [S]: 1.0 to 2.0 V • Pulse length = other than [S]:2.0 to 3.0 V	-
	[INI TUNE IND]	Pulse length = [S]: 1.0 to 2.0 V • Pulse length = other than [S]:2.0 to 3.0 V	-
	[IF FREQ]	• Pulse length = [S], [M1]: 0.0 Hz • Pulse length = other than [S], [M1]: 55.0 to 65.0 Hz	-
	[FAN SPEED]	3000 to 4000 rpm	-
	[TEMP]	-15 to +85°C	-

7.8 Sentence Monitor

You can check which sentences input to the radar.

1. Open the [MAIN MENU].
2. Select [9 INITIAL SETTINGS].
3. Select [7 TESTS].
4. Select [3 SENTENCE MONITOR].
5. Select the item you want to check.
All sentences input to the radar for the selected item appear on the screen.
Press the **F3** key to save the sentence information to the SD Card.
Press the **F4** key to save a screenshot to the SC Card.

SENTENCE MONITOR	
1	BACK
2	HDG
3	GPS
4	LOG
5	AIS
6	AMS
7	ECDIS
8	LAN1
9	LAN2

- Note:** If a SD Card is not connected to the Processor Unit, you cannot save sentence information or screenshots.
6. Press the **F1** key to close the sentence information.
 7. Repeat steps 5 and 6 to view other sentence information as required.
 8. Close the menu.

7.9 Fallback Arrangements

If the top priority sensor (for example EPFS1) cannot be used, this equipment automatically uses the second priority sensor (for example, EPFS2) when multiple sensors (EPFS1 and EPFS2 for example) are installed. When there is no fallback sensor available, each function is limited as follows:

Sensor	Function limitations
Heading sensor	<ul style="list-style-type: none"> The [HDG] indication reads "****. *°" The orientation mode is automatically set to [HEAD-UP]. TT, AIS, radar map and echo averaging are disabled.
Speed sensor	When [LOG(WT)] is selected: <ul style="list-style-type: none"> The sensor used is automatically switched in the following priority order: EPFS(BT) > LOG(BT). The SPD indication reads "****. * kn" when both EPFS(BT) and LOG(BT) cannot be used.
	When [LOG(BT)] is selected: <ul style="list-style-type: none"> The sensor used is automatically switched in the following priority order: EPFS(BT) > LOG(WT). The SPD indication reads "****. * kn" when both EPFS(BT) and LOG(WT) cannot be used.
	When [EPFS(BT)] is selected: <ul style="list-style-type: none"> The sensor used is automatically switched in the following priority order: LOG(BT) > LOG(WT). The SPD indication reads "****. * kn" when both LOG(BT) and LOG(WT) cannot be used.
COG/SOG sensor	<ul style="list-style-type: none"> When the EPFS sensor cannot be used, the values of COG and SOG are calculated from HDG and LOG(BT). Additionally when the heading sensor cannot be used, the values of SOG is calculated from LOG(BT). The COG indication reads "****. *°".
Position sensor	<ul style="list-style-type: none"> The POSN indication reads all asterisks. AIS and radar map are disabled.

APPENDIX 1 MENU TREE

Press MENU key, or click MENU box.

Default settings in ***bold italic***.

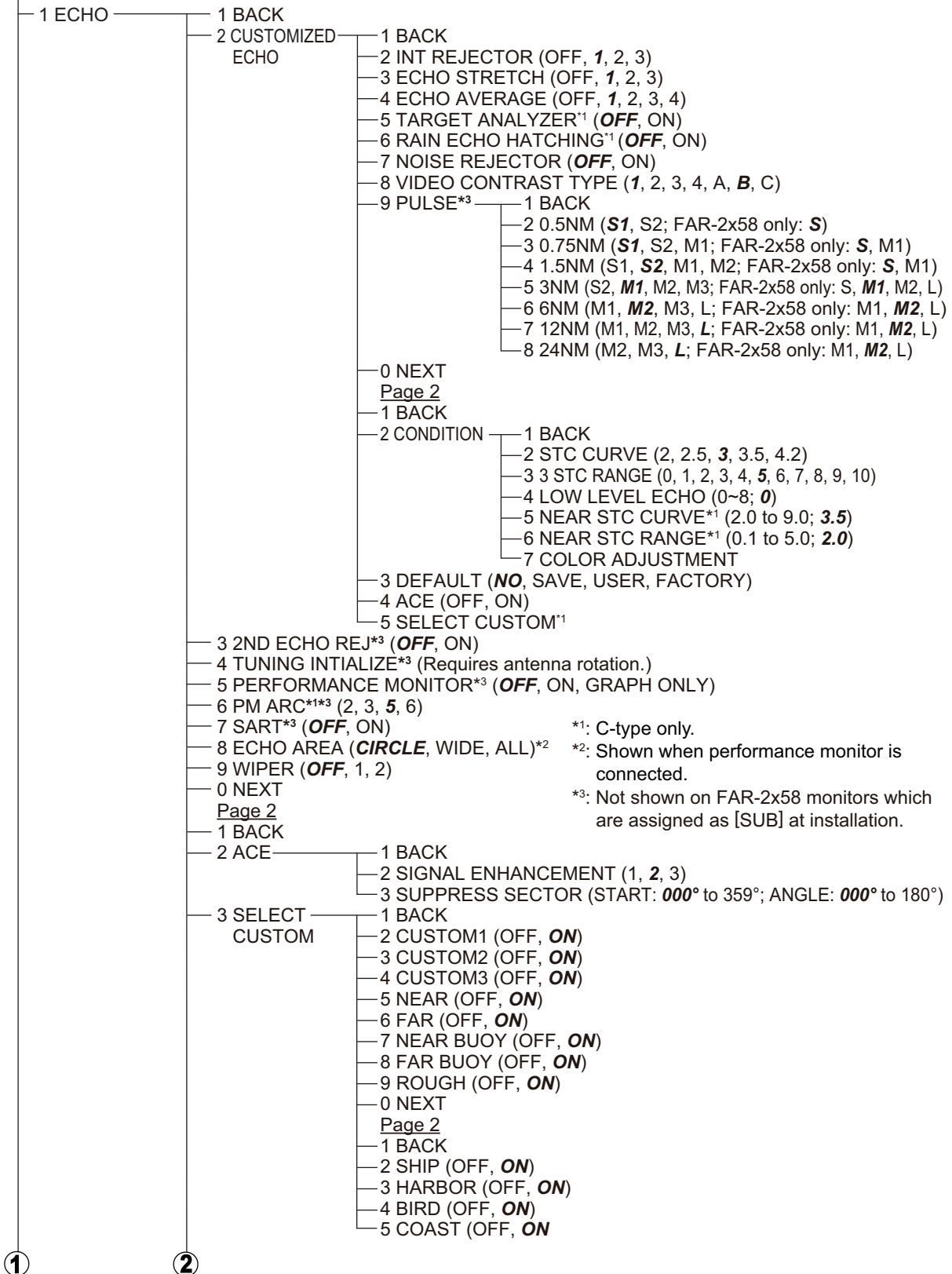

APPENDIX 1 MENU TREE

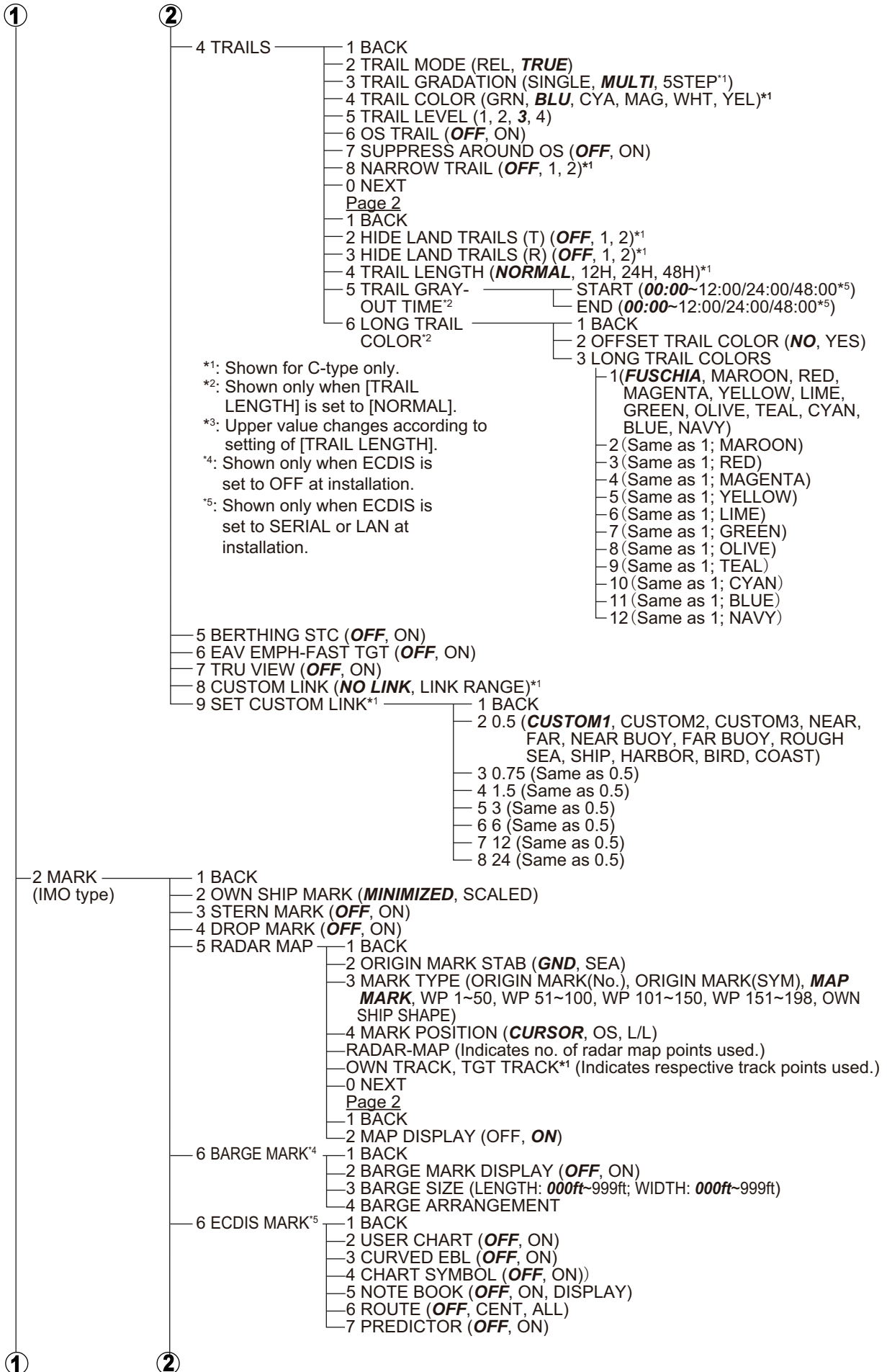

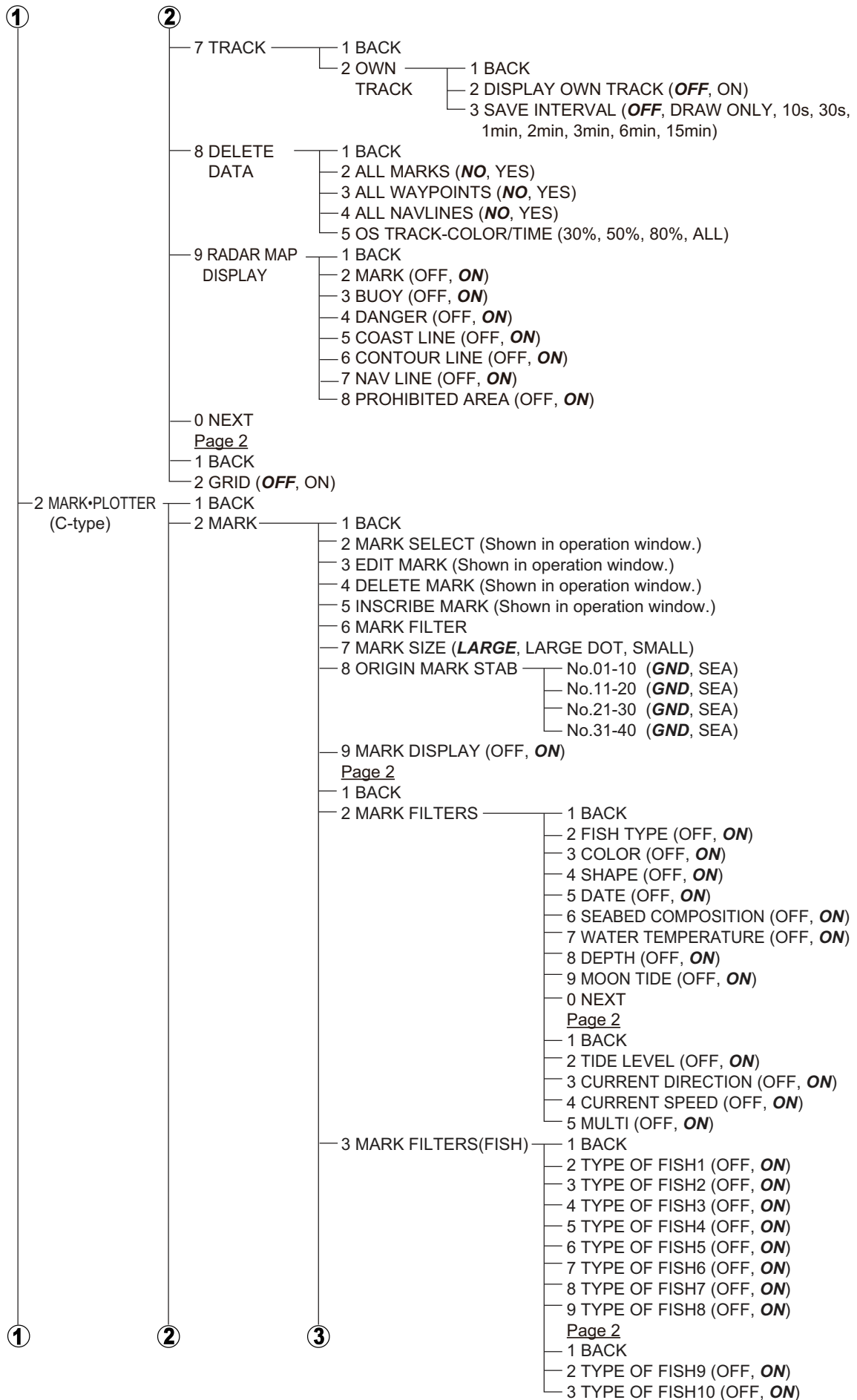

APPENDIX 1 MENU TREE

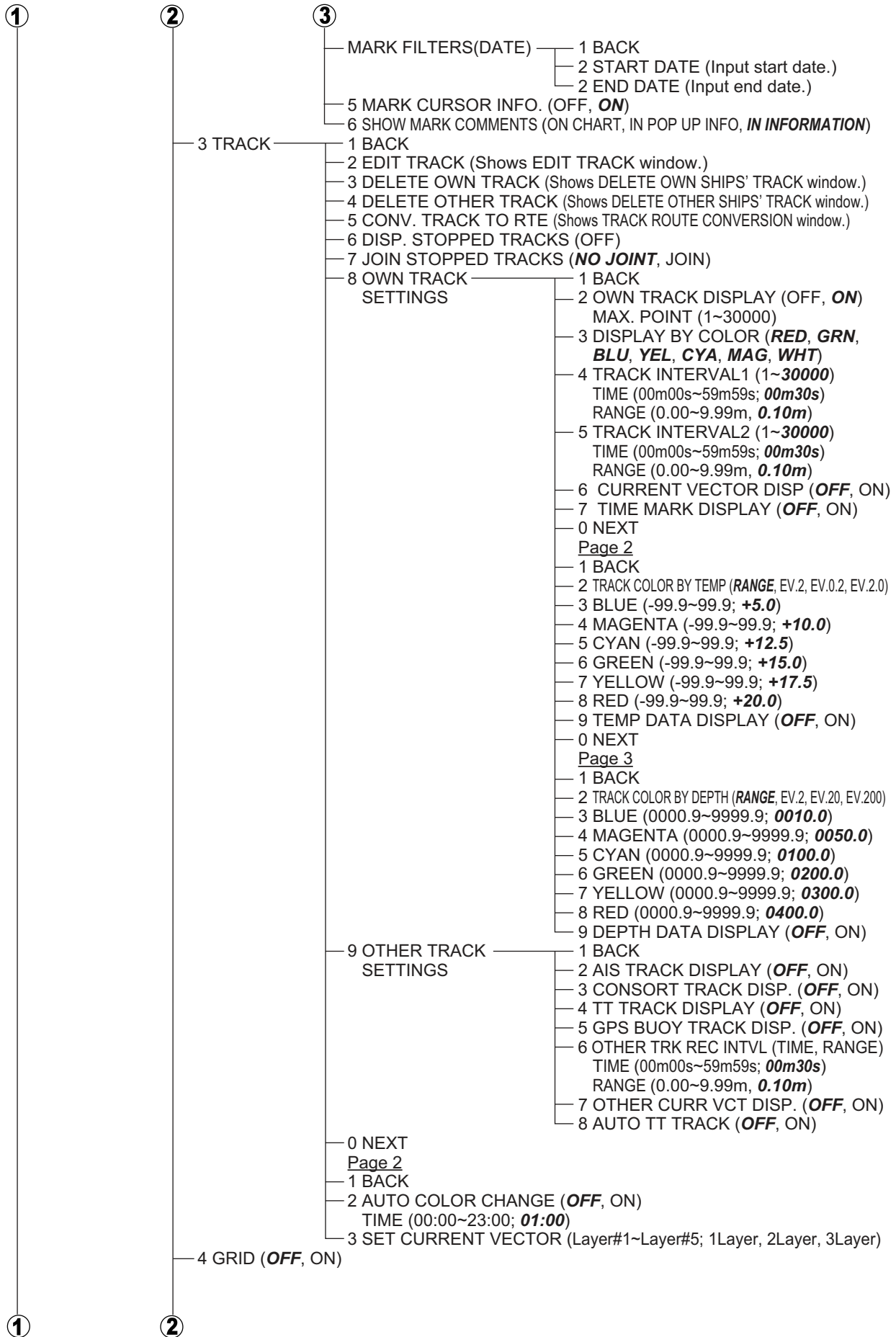

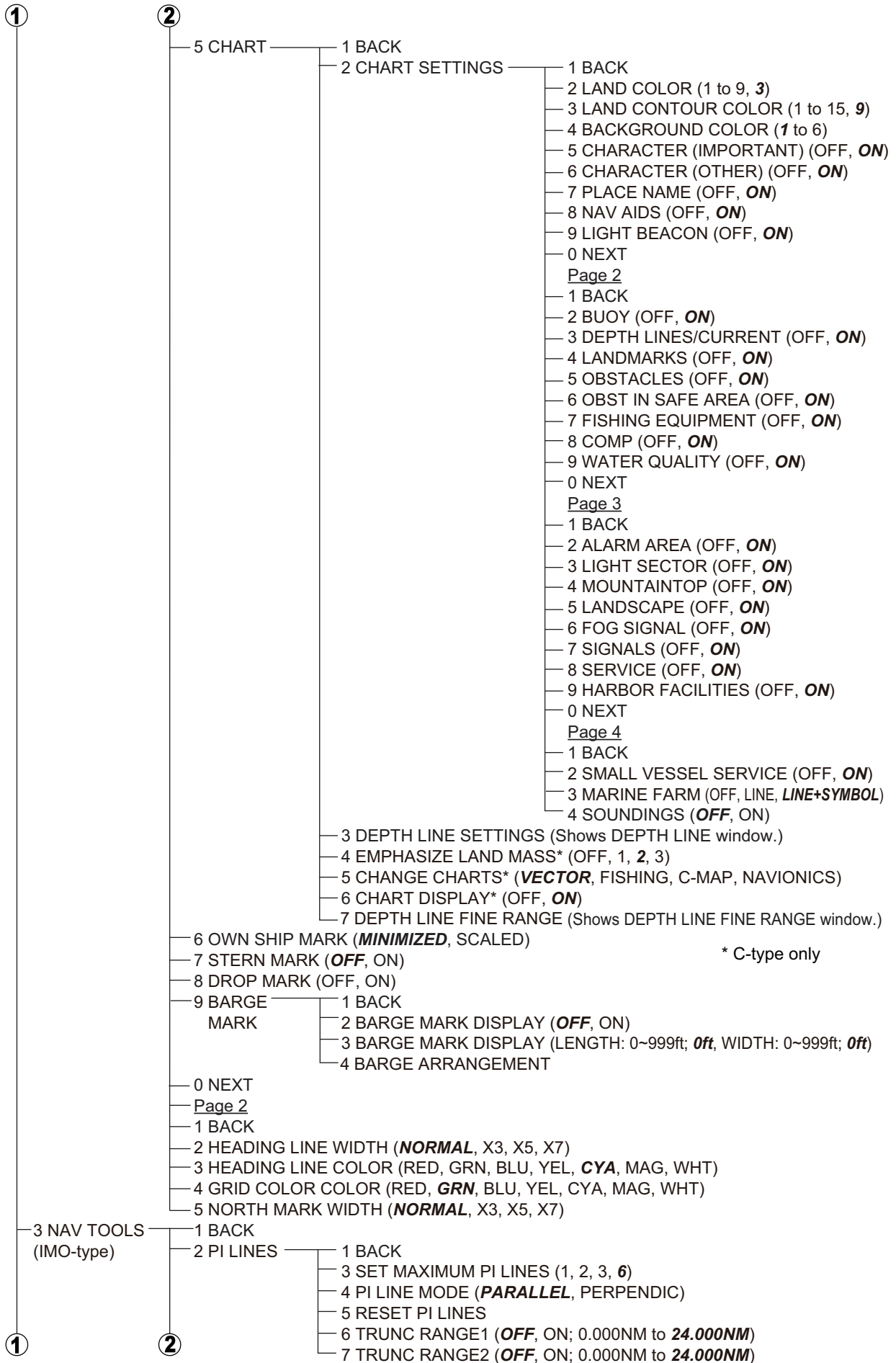

APPENDIX 1 MENU TREE

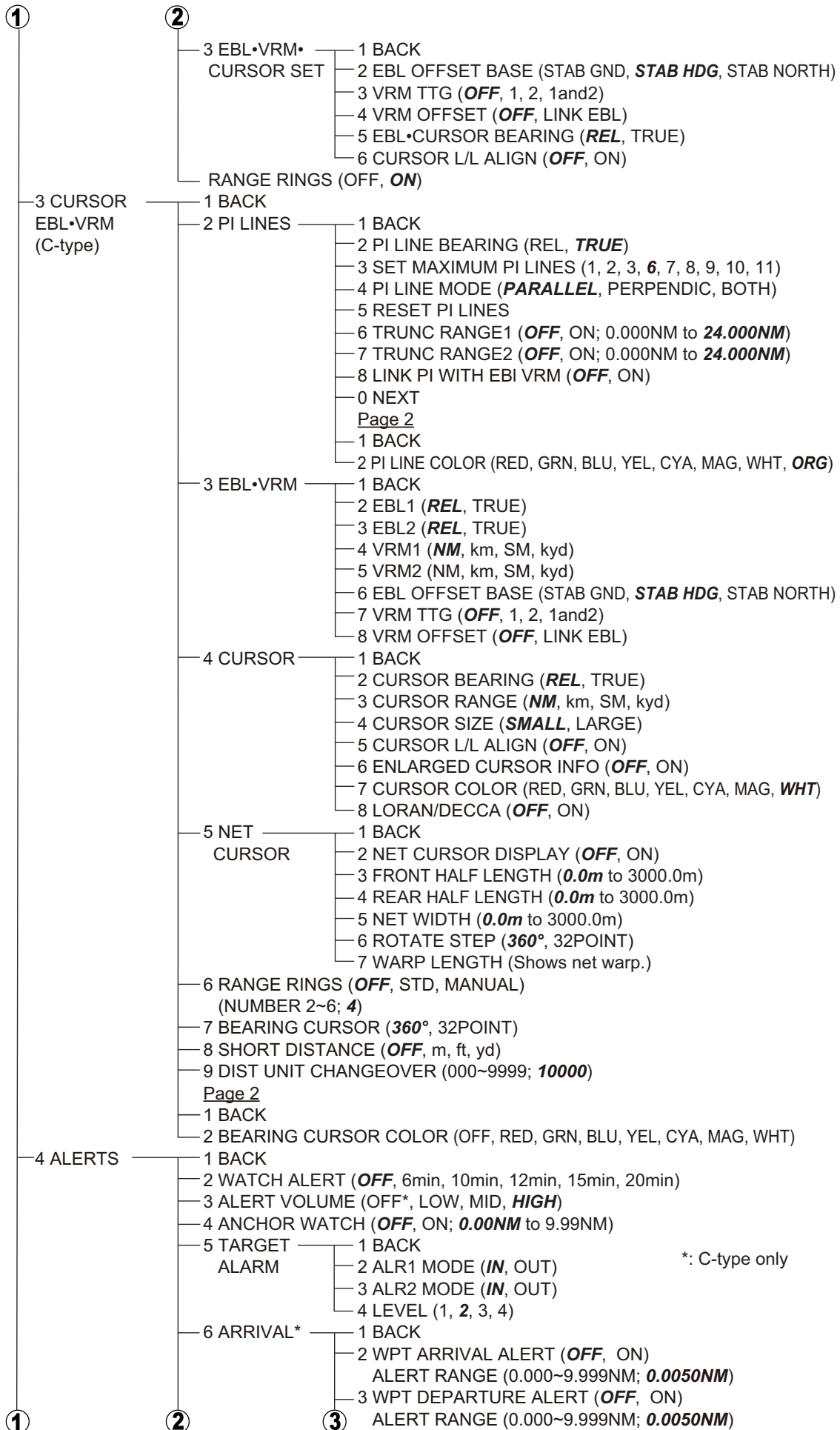

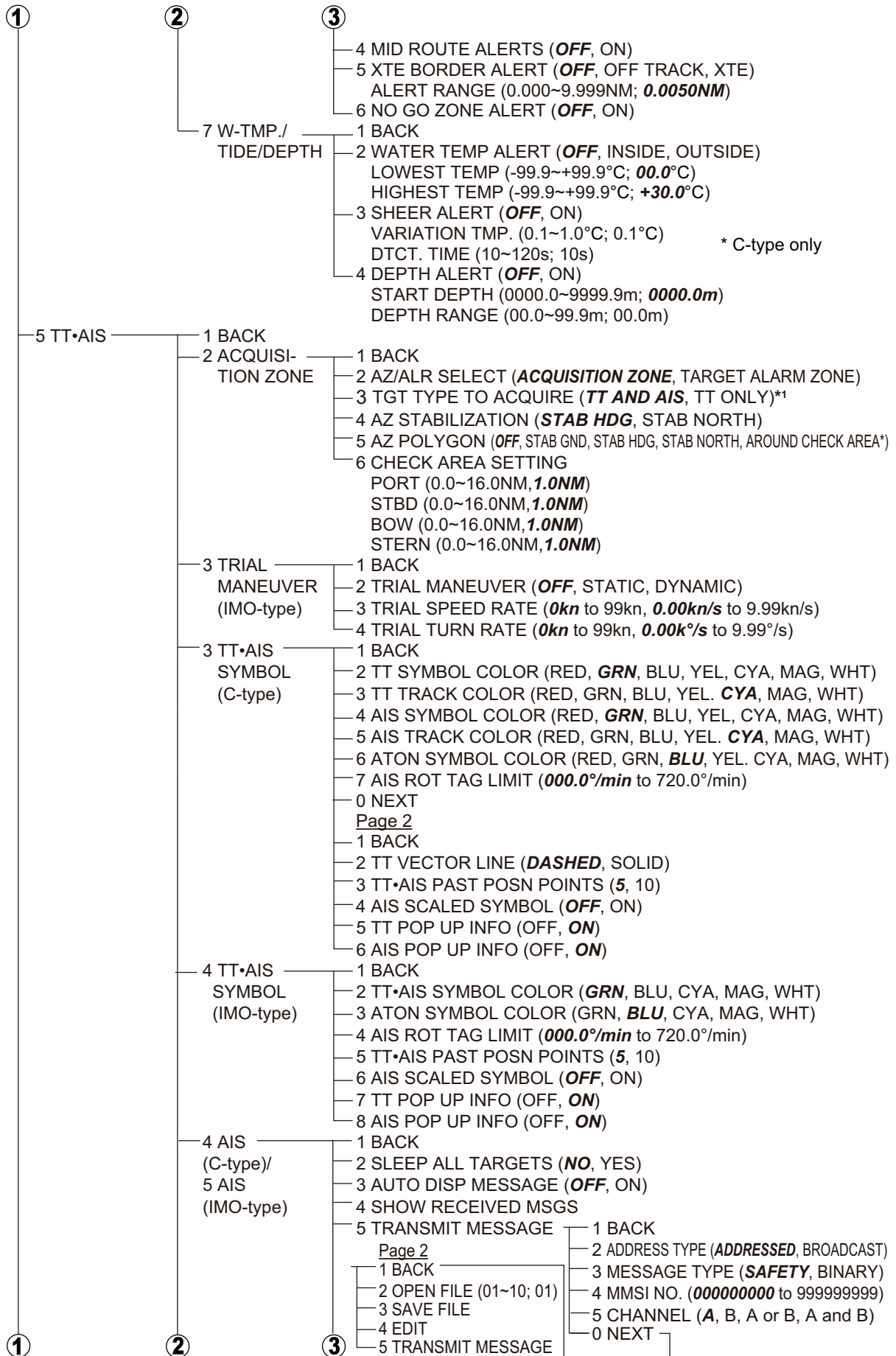

APPENDIX 1 MENU TREE

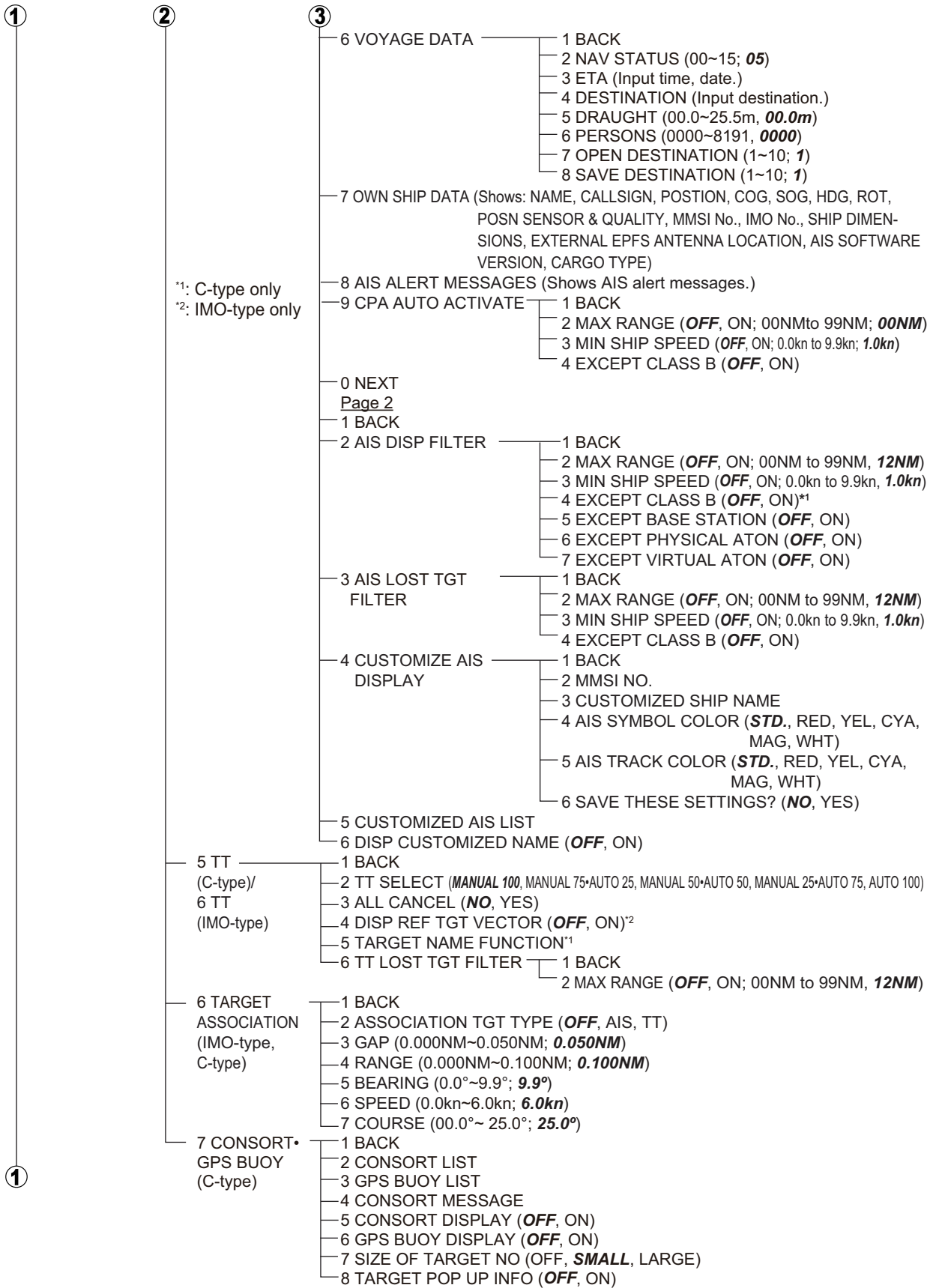

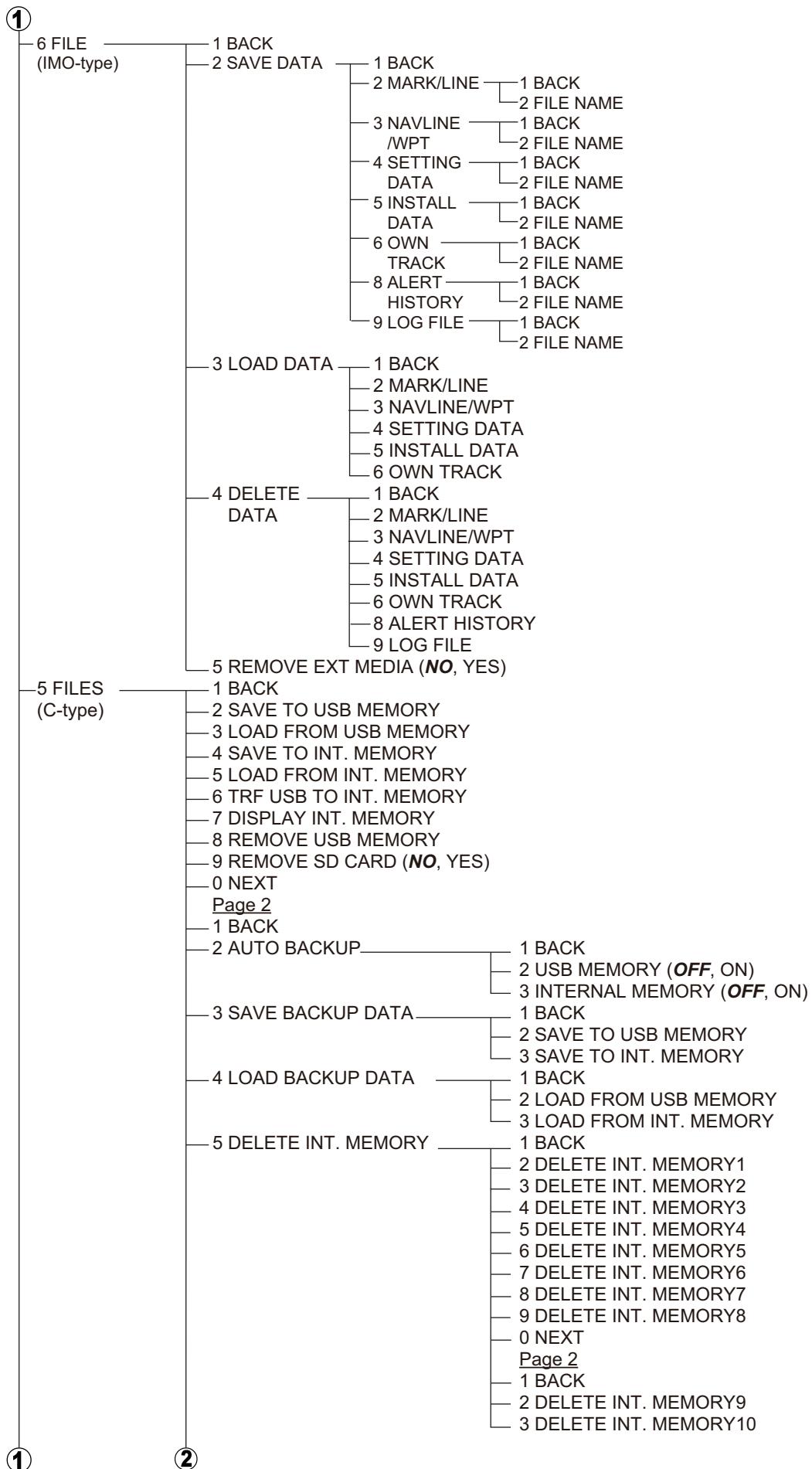

APPENDIX 1 MENU TREE

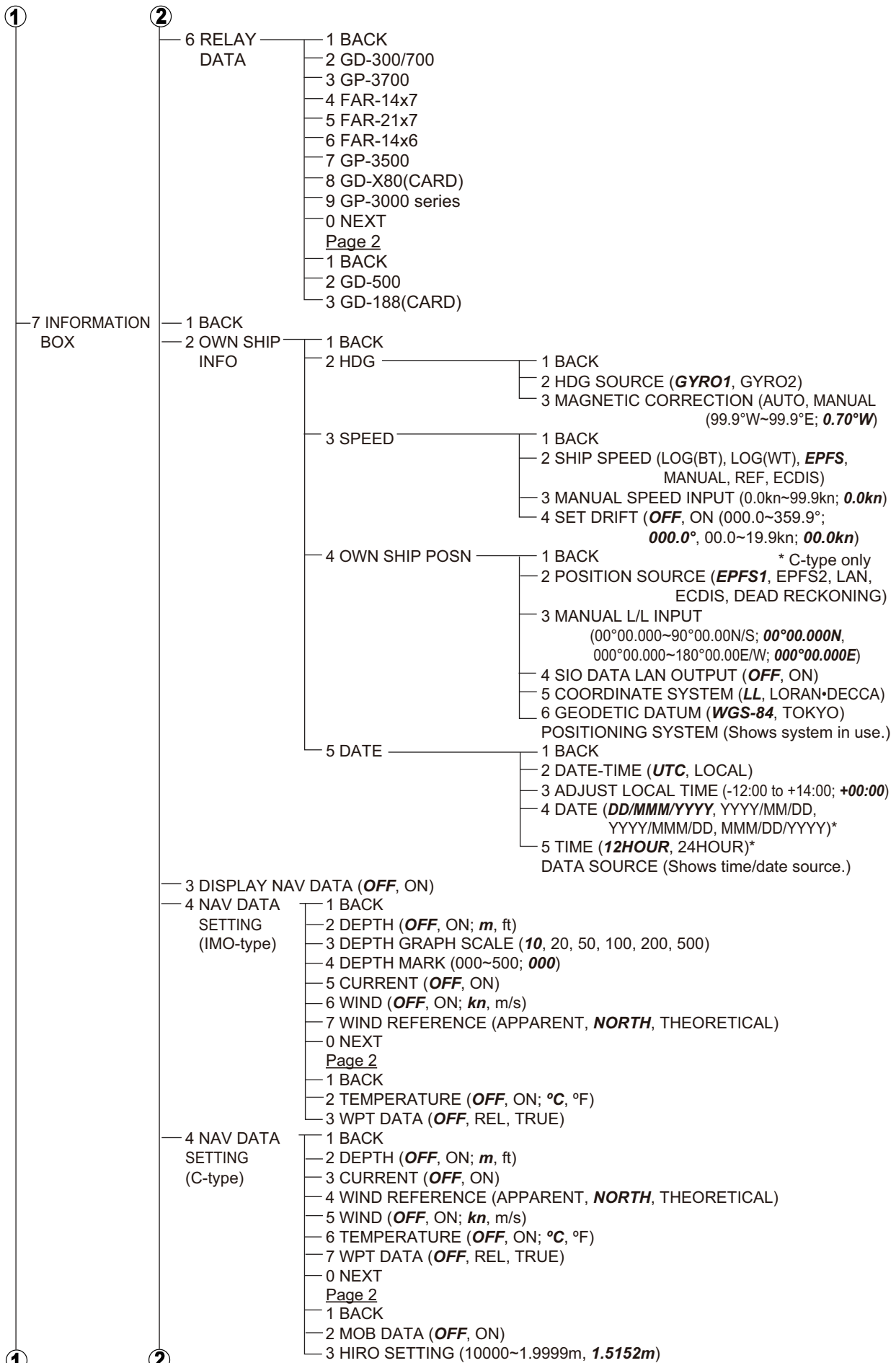

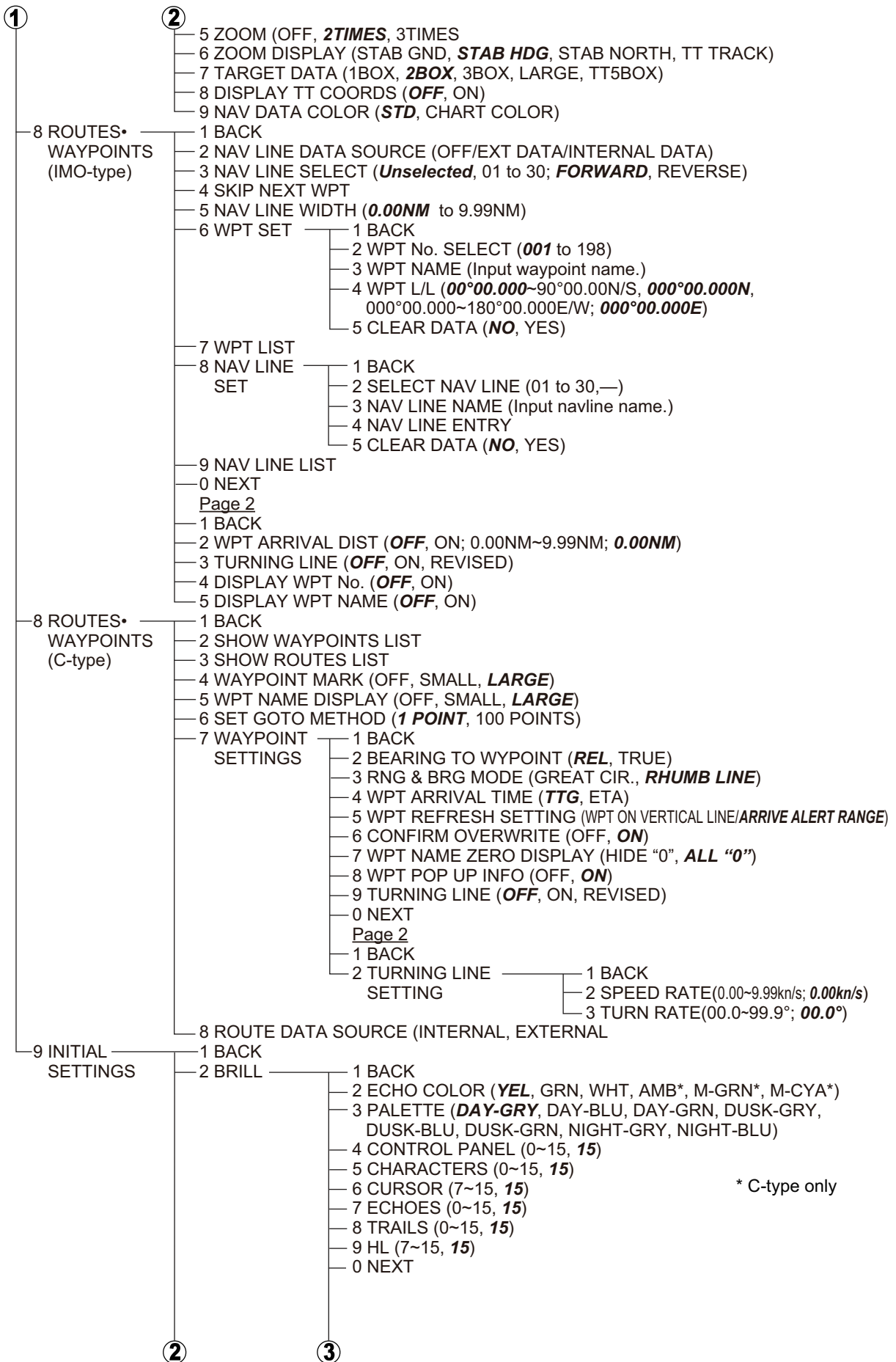

* C-type only

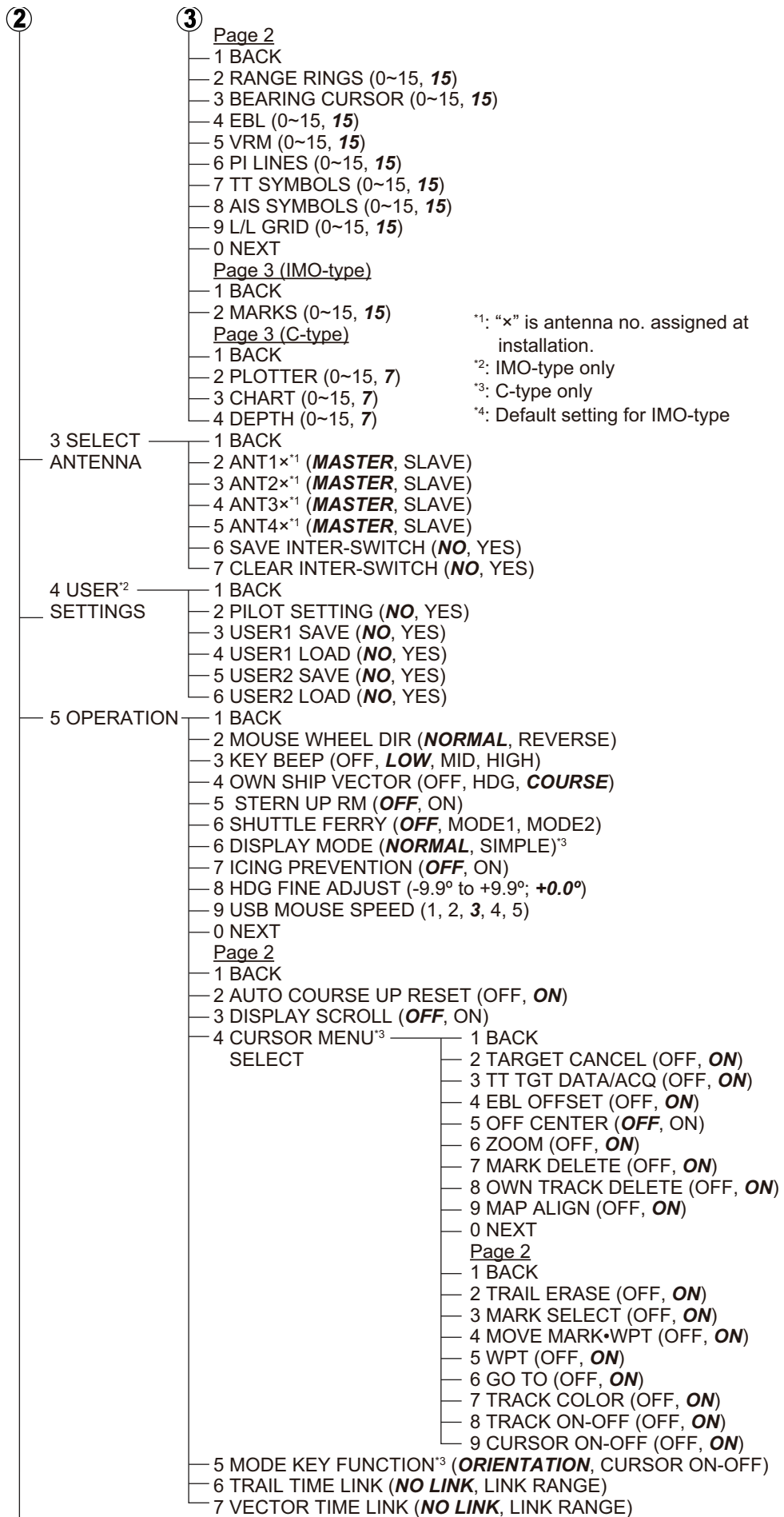

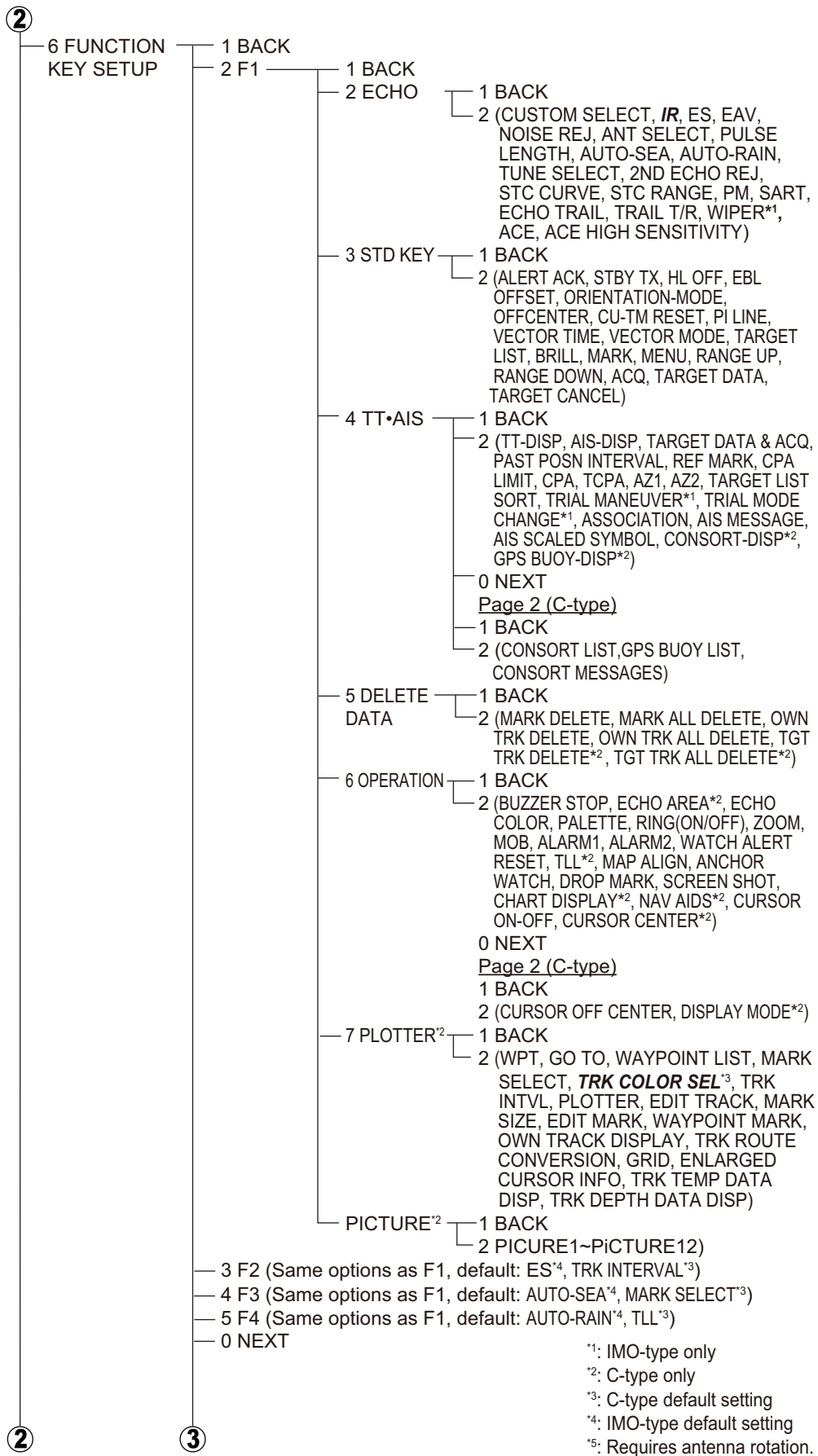

APPENDIX 1 MENU TREE

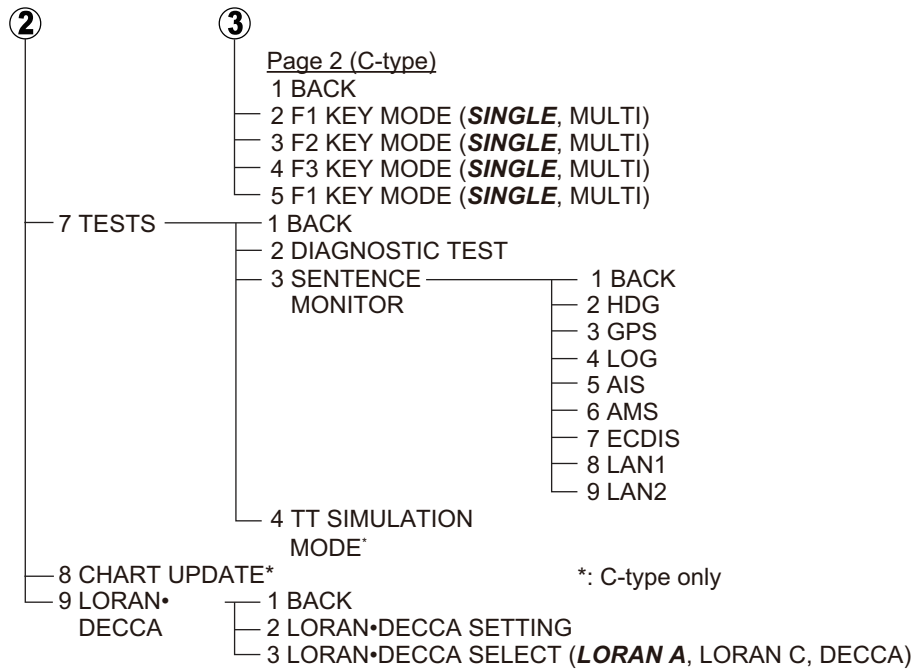

Right-click the display.

Default settings in bold italic.

- 2 (TARGET DATA / ACQ, TARGET CANCEL, TT TGT DATA / ACQ^{*1}, EBL OFFSET, OFF CENTER, ZOOM, MARK DELETE, OWN TRACK DELETE, MAP ALIGN, TRAIL ERASER², MARK SELECT², MOVE MARK•WPT², WPT², GO TO², TRACK COLOR², TRACK ON-OFF², CURSOR ON-OFF²)
 - 0 NEXT
 - Page 2
 - 1 BACK
 - 2 TGT DATA/ACQ SETTING (**ANY**, TT ONLY, AIS ONLY)
 - 3 TGT CANCEL SETTING (**ANY**, TT ONLY, AIS ONLY)
 - 4 CIRCLE CURSOR^{*1}
 - 5 REF MARK^{*1}
- *¹: IMO-type only
*²: C-type only

APPENDIX 2 LONGITUDE ERROR TABLE (96 NM SCALE)

The longitude lines concentrate on the north pole and south pole, namely, 1 nm is equivalent to 1 minute at 0 degree latitude, 2 minutes at 60 degrees latitude, 3 minutes at 70 degrees latitude and so on. For this reason, a longitude error occurs on the radar display.

For example, when own ship is at 60°N and 135°E, even if the cursor indication is 62°N and 139°E, the real cursor position is deviated to the left (west) side. The table below shows the longitude error, represented from 0° to 90° at 96 nm from the radar center (own ship).

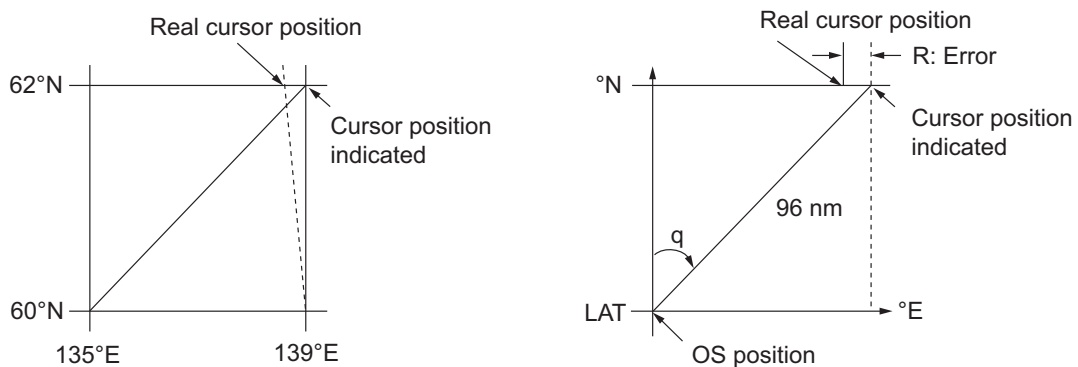

		(nm)								
LAT \ q	5°	10°	15°	20°	25°	30°	35°	40°	45°	
75°	0.2256	0.4444	0.6496	0.8350	0.9950	1.1248	1.2202	1.2786	1.2980	
70°	0.21980213	0.43290201	0.632803	0.8134132	0.96923215	1.09551918	1.1884382	1.24517456	1.26402037	
65°	0.21229339	0.41810678	0.61115946	0.78556318	0.93600295	1.05790007	1.14755221	1.20224625	1.22034042	
60°	0.20316898	0.40012949	0.58486463	0.75173456	0.89565021	1.0122297	1.09793265	1.15016811	1.16737294	
55°	0.19249832	0.37910698	0.55411863	0.71218478	0.84848102	0.95885565	1.03998717	1.08933651	1.10552105	
50°	0.18036264	0.35519924	0.51915545	0.66721485	0.79485438	0.89818413	0.97406698	1.02021439	1.03525547	
45°	0.16685429	0.32858822	0.48024119	0.61716701	0.73517843	0.83067689	0.90076355	0.94332783	0.95711098	
40°	0.15207608	0.29947644	0.437672	0.56242216	0.66990732	0.7568477	0.82060477	0.85926197	0.87168229	
35°	0.13614047	0.26808546	0.39177186	0.53339693	0.59953781	0.67725844	0.73420069	0.76865661	0.77961957	
30°	0.11916876	0.2346542	0.3428901	0.44054055	0.52460545	0.59251483	0.6422089	0.67220131	0.68162348	
25°	0.10129001	0.19943707	0.29139874	0.37433139	0.44568053	0.50326182	0.54532952	0.57063015	0.57843983	
20°	0.08264056	0.16270211	0.23768966	0.30527334	0.36336372	0.41017869	0.44429984	0.46471615	0.47085389	
15°	0.06336208	0.12472888	0.18217162	0.23389198	0.27828148	0.31397386	0.33988878	0.35526538	0.35968447	
10°	0.04360137	0.0858064	0.12526714	0.16073056	0.19108136	0.21537949	0.23289096	0.24311083	0.24577764	
5°	0.02350833	0.04623087	0.0674093	0.08634588	0.10242699	0.11514595	0.1241207	0.12910605	0.13000029	
0°	0.00323737	0.0063035	0.00903844	0.01130406	0.01299309	0.01403609	0.0144058	0.0141187	0.01323356	

APPENDIX 2 LONGITUDE ERROR TABLE (96 NM SCALE)

(nm)

LAT \ q	50°	55°	60°	65°	70°	75°	80°	85°	90°
75°	1.2780	1.2192	1.1233	0.9933	0.8332	0.6479	0.4431	0.2249	0
70°	1.24442563	1.18701379	1.09356117	0.96694117	0.81103484	0.3061092	0.43117887	0.21881975	0
65°	1.20131324	1.14577786	1.05546143	0.93315023	0.78260251	0.60843159	0.41596331	0.21107193	0
60°	1.14905813	1.09582188	1.00932899	0.89225746	0.74821409	0.58162173	0.397582	0.20171772	0
55°	1.08805799	1.03752602	0.95551494	0.84457408	0.70813132	0.55038538	0.37617487	0.19082831	0
50°	1.0187708	0.97133397	0.89442885	0.79046297	0.66265924	0.51496026	0.35190481	0.17848659	0
45°	0.94174265	0.89774948	0.82653562	0.73033596	0.61214392	0.47561599	0.32495654	0.16478648	0
40°	0.85754099	0.81733258	0.75235195	0.66465066	0.55696981	0.43265198	0.29553516	0.14983224	0
35°	0.76681293	0.73069528	0.63744242	0.59390696	0.49755683	0.38639524	0.26386458	0.13373769	0
30°	0.67024897	0.63849695	0.58741521	0.51864327	0.43435714	0.33719779	0.23018583	0.11662531	0
25°	0.568584	0.54143927	0.49791741	0.43943239	0.36785173	0.28543407	0.19475522	0.09862535	0
20°	0.46259176	0.44026091	0.40463016	0.35687717	0.29854675	0.23149802	0.15784242	0.07987479	0
15°	0.35307892	0.3357319	0.30826343	0.2716059	0.22696965	0.17580013	0.11972833	0.06051633	0
10°	0.2487894	0.22864776	0.20955062	0.18426754	0.15366517	0.1187643	0.08070304	0.0406973	0
5°	0.12684572	0.11982348	0.10624302	0.09552679	0.0791912	0.04106355	0.04106355	0.02056855	0
0°	0.01184713	0.01008727	0.008104	0.00605903	0.00411455	0.00111154	0.00111154	0.00028325	0

APPENDIX 3 ALERT CODES, MESSAGES & MEANINGS

For ALF format alerts, the alert identifier (the first three/five digits of the alert code), is displayed on the alert list and in the alert box. The alert instance (the last one or two digits of the alert code), is transferred along with its identifier to the connected Bridge Alert Management System. The table below shows the alert ID for ALF format alerts, with the instance separated by a comma. ALR format alerts have no instance assigned.

ALR Alert ID	ALF Alert ID	Alert title	Priority & Category	Alert description
-	52190,1	TARGET CAPACITY	Caution Cat: B	Message: "TT TARGET 95%(AUTO)" Meaning: Automatically acquired target capacity has reached 95%.
Remedy: Press the ALARM ACK key. Remove TT symbols manually.				
523	190,2	TARGET CAPACITY	Warning Cat: A	Message: "TT TARGET FULL(AUTO)" Meaning: Automatically acquired target capacity has reached 100%.
Remedy: Press the ALARM ACK key. Remove TT symbols manually.				
-	52190,3	TARGET CAPACITY	Caution Cat: B	Message: "TT TARGET 95%(MAN)" Meaning: Manually acquired target capacity has reached 95%.
Remedy: Press the ALARM ACK key. Remove TT symbols manually.				
525	190,4	TARGET CAPACITY	Warning Cat: A	Message: "TT TARGET FULL(MAN)" Meaning: Manually acquired target capacity has reached 100%.
Remedy: Press the ALARM ACK key. Remove TT symbols manually.				
-	52190,5	TARGET CAPACITY	Caution Cat: B	Message: "AIS DISPLAY 95%" Meaning: AIS display capacity has reached 95% (333 targets).
Remedy: Press the ALARM ACK key. Adjust [AIS DISP FILTER] settings to decrease the number of targets displayed.				
531	190,6	TARGET CAPACITY	Warning Cat: A	Message: "AIS DISPLAY FULL" Meaning: AIS display capacity has reached 100% (350 targets).
Remedy: Press the ALARM ACK key. Adjust [AIS DISP FILTER] settings to decrease the number of targets displayed.				
-	52190,8	TARGET CAPACITY	Caution Cat: B	Message: "AIS CAPACITY FULL" Meaning: AIS capacity has reached 100% (1200 targets).
Remedy: Press the ALARM ACK key. Adjust [AIS DISP FILTER] settings to decrease the number of targets displayed.				
-	52190,9	TARGET CAPACITY	Caution Cat: B	Message: "ACTIVE AIS 95%" Meaning: Active AIS target capacity has reached 95% (48 targets).
Remedy: Press the ALARM ACK key. Sleep all unnecessary AIS targets.				
535	190,10	TARGET CAPACITY	Warning Cat: A	Message: "ACTIVE AIS FULL" Meaning: Active AIS target capacity has reached 100% (50 targets).
Remedy: Press the ALARM ACK key. Sleep all unnecessary AIS targets.				

APPENDIX 3 ALERT CODES, MESSAGES & MEANINGS

ALR Alert ID	ALF Alert ID	Alert title	Priority & Category	Alert description
526	191,1	CPA/TCPA	Alarm Cat: A	Message: "TT DANGER OF COLLISION" Meaning: TT is within CPA/TCPA threshold, danger of collision.
Remedy: Press the ALARM ACK key. Take evasive action if necessary. Adjust CPA/TCPA settings.				
536	191,2	CPA/TCPA	Alarm Cat: A	Message: "AIS DANGER OF COLLISION" Meaning: AIS target is within CPA/TCPA threshold, danger of collision.
Remedy: Press the ALARM ACK key. Take evasive action if necessary. Adjust CPA/TCPA settings.				
521	192,1	NEW TARGET	Warning Cat: A	Message: "TT NEW TARGET" Meaning: A new TT target has entered the Acquisition Zone.
Remedy: Press the ALARM ACK key. Confirm location of new target.				
529	192,2	NEW TARGET	Warning Cat: A	Message: "AIS NEW TARGET" Meaning: A new AIS target has entered the Acquisition Zone.
Remedy: Press the ALARM ACK key. Confirm location of new target.				
527	193,1	LOST TARGET	Warning Cat: A	Message: "TT TARGET LOST" Meaning: TT target is lost.
Remedy: Press the ALARM ACK key. Lost target indication (blinking in red) is removed.				
528	193,2	LOST TARGET	Warning Cat: A	Message: "REF TARGET LOST" Meaning: REF targets is lost.
Remedy: Press the ALARM ACK key. Lost target indication (blinking in red) is removed.				
537	193,3	LOST TARGET	Warning Cat: A	Message: "AIS TARGET LOST" Meaning: AIS target is lost.
Remedy: Press the ALARM ACK key. Lost target indication (blinking in red) is removed.				
720	194,1	SYSTEM ERROR	Warning Cat: B	Message: "NO HEADLINE SIGNAL" Meaning: Heading marker signal interrupted/lost.
Remedy: Press the ALARM ACK key. Restore signal or rectify reason for signal loss.				
721	194,2	SYSTEM ERROR	Warning Cat: B	Message: "NO AZIMUTH SIGNAL" Meaning: Antenna signal is interrupted/lost.
Remedy: Press the ALARM ACK key. Restore signal or rectify reason for signal loss.				
722	194,3	SYSTEM ERROR	Warning Cat: B	Message: "NO TRIGGER SIGNAL" Meaning: Antenna trigger interrupted/lost
Remedy: Press the ALARM ACK key. Restore signal or rectify reason for signal loss.				
723	194,4	SYSTEM ERROR	Warning Cat: B	Message: "NO VIDEO SIGNAL" Meaning: Video signal interrupted/lost.
Remedy: Press the ALARM ACK key. Restore signal or rectify reason for signal loss.				
70	194,5	SYSTEM ERROR	Warning Cat: B	Message: "CTRL UNIT COM ERROR" Meaning: Keyboard (RCU-014/015/016) signal interrupted/lost.
Remedy: Press the ALARM ACK key. Restore signal or rectify reason for signal loss.				
782	194,6	SYSTEM ERROR	Warning Cat: B	Message: "PM COM ERROR" Meaning: PM communication error.
Remedy: Press the ALARM ACK key. Restore signal or rectify reason for signal loss.				

ALR Alert ID	ALF Alert ID	Alert title	Priority & Category	Alert description
48	194,7	SYSTEM ERROR	Warning Cat: B	Message: "TUNE ERROR" Meaning: TUNE error due to faulty settings or malfunction.
Remedy: Press the ALARM ACK key. Restore signal or rectify reason for signal loss.				
727	194,8	SYSTEM ERROR	Warning Cat: B	Message: "RADAR ANT COM ERROR" Meaning: Signal between processor and antenna interrupted/lost.
Remedy: Press the ALARM ACK key. Restore signal or rectify reason for signal loss.				
781	194,9	SYSTEM ERROR	Warning Cat: B	Message: "MTR-DRV COM ERROR" Meaning: Signal between antenna's SPU and MTR-DRV interrupted/lost.
Remedy: Press the ALARM ACK key. Restore signal or rectify reason for signal loss.				
783	194,10	SYSTEM ERROR	Warning Cat: B	Message: "RF-CONVERTER COM ERROR" Meaning: Signal between antenna's SPU and RF-CONVERTER interrupted/lost.
Remedy: Press the ALARM ACK key. Restore signal or rectify reason for signal loss.				
784	194,11	SYSTEM ERROR	Warning Cat: B	Message: "LAN1 NETWORK ERROR" Meaning: LAN1 IP address is use by other equipment.
Remedy: Press the ALARM ACK key. Check IP settings and assign a unique IP address.				
785	194,12	SYSTEM ERROR	Warning Cat: B	Message: "LAN2 NETWORK ERROR" Meaning: LAN1 IP address is use by other equipment.
Remedy: Press the ALARM ACK key. Check IP settings and assign a unique IP address.				
786	194,13	SYSTEM ERROR* ⁶	Warning Cat: B	Message: "RP COM ERROR" Meaning: Signal between MAIN board and RP board in the processor is interrupted or lost.
Remedy: Press the ALARM ACK key. Restore the signal or rectify the reason for the signal loss.				
787	194,14	SYSTEM ERROR* ⁶	Warning Cat: B	Message: "NO TUNE GATE SIGNAL" Meaning: No tune gate signal from the FAR-2x58 antenna.
Remedy: Press the ALARM ACK key. Consult your local dealer for service.				
788	194,15	SYSTEM ERROR* ⁶	Warning Cat: B	Message: "RP VERSION MISMATCH" Meaning: MAIN board and RP board software versions do not match.
Remedy: Press the ALARM ACK key. Consult your dealer for a software update.				
789	194,16	SYSTEM ERROR* ⁶	Warning Cat: B	Message: "TX-HV ERROR" Meaning: FAR-2x58 Antenna voltage is below 300 V.
Remedy: Press the ALARM ACK key. Turn the PSU-019 power on. If the problem persists, consult your local dealer for service.				
485	52485,1	DEPTH	Warning Cat: B	Message: "DEPTH ALERT" Meaning: Ship position outside set anchor watch zone.
Remedy: Press the ALARM ACK key. Confirm Own Ship location and adjust as necessary.				

APPENDIX 3 ALERT CODES, MESSAGES & MEANINGS

ALR Alert ID	ALF Alert ID	Alert title	Priority & Category	Alert description
495	52495,1	ANCHOR WATCH	Warning Cat: B	Message: "OUT OF ANCHOR WATCH ZONE" Meaning: Ship position outside set anchor watch zone.
Remedy: Press the ALARM ACK key. Confirm Own Ship location and adjust as necessary.				
-	52540,1	AIS MSG	Caution Cat: B	Message: "TRANSMIT ERROR" Meaning: Unable to transmit AIS binary message.
Remedy: Press the ALARM ACK key. Check power to AIS unit.				
450	52601,1	SENSOR ERROR	Warning Cat: B	Message: "NO GYRO SIGNAL" Meaning: No heading information received from gyrocompass for five seconds.
Remedy: Press the ALARM ACK key. Match the on-screen indication with the actual gyrocompass.				
278	52601,2	SENSOR ERROR* ¹	Warning/ Caution Cat: B	Message: "NO LOG(WT) SIGNAL" Meaning: No speed data received for five seconds when [LOG(WT)] is set as speed reference.
Remedy: Press the ALARM ACK key. Check SDME sensor. Use a different sensor if necessary.				
284	52601,3	SENSOR ERROR* ²	Warning/ Caution Cat: B	Message: "NO LOG(BT) SIGNAL" Meaning: No speed data received for thirty seconds when [LOG(BT)] is set as speed reference.
Remedy: Press the ALARM ACK key. Check SDME sensor. Use a different sensor if necessary.				
170	52601,4	SENSOR ERROR	Warning Cat: B	Message: "NO POSITION SIGNAL" Meaning: EPFS Error. No position data received from EPFS device for thirty seconds.
Remedy: Press the ALARM ACK key. Restore the signal. This indication cannot be erased if the position signal is missing. The indication is automatically removed when the signal is restored.				
469	52601,5	SENSOR ERROR	Warning Cat: B	Message: "POSITION DATUM UNKNOWN" Meaning: DTM sentence not received for thirty seconds, or erroneous data received.
Remedy: Press the ALARM ACK key. Use the WGS-84 datum.				
272	52601,6	SENSOR ERROR	Warning Cat: B	Message: "NO UTC SIGNAL" Meaning: UTC error. No date or time data received for thirty seconds. No ZDA sentence input.
Remedy: Press the ALARM ACK key. Restore the signal to remove this indication.				
380	52601,7	SENSOR ERROR	Warning Cat: B	Message: "AIS COM ERROR" Meaning: No AIS data received for thirty seconds. Note: When [AIS FUNC] is set to [OFF], this message is prioritized as a Caution level alert; when [AIS FUNC] is set to [ON], it is prioritized as a Warning level alert.
Remedy: Press the ALARM ACK key. Check power and connection to AIS unit.				

ALR Alert ID	ALF Alert ID	Alert title	Priority & Category	Alert description
279	52601,8	SENSOR ERROR	Warning Cat: B	Message: "NO COG/SOG SIGNAL" Meaning: EPFS Error. No COG/SOG data received from EPFS device for thirty seconds.
Remedy: Press the ALARM ACK key. Restore the signal. This indication cannot be erased if the COG/SOG signal is missing. The indication is automatically removed when the signal is restored.				
50	52601,9	SENSOR ERROR	Warning Cat: B	Message: "ECDIS COM ERROR" Meaning: No ECDIS data received for thirty seconds.
Remedy: Press the ALARM ACK key. Check power and connection to ECDIS unit.				
-	52602,1	SOURCE CHANGE	Caution Cat: B	Message: "POSN SOURCE CHG" Meaning: Positioning sensor input lost, automatically changed sensors.
Remedy: Press the ALARM ACK key. The indication is automatically removed when the signal is restored or a different sensor is selected.				
-	52602,2	SOURCE CHANGE	Caution Cat: B	Message: "SPD SOURCE CHG" Meaning: Speed sensor input lost, automatically changed sensors.
Remedy: Press the ALARM ACK key. The indication is automatically removed when the signal is restored or a different sensor is selected.				
-	52602,3	SOURCE CHANGE	Caution Cat: B	Message: "HDG SOURCE CHG" Meaning: Heading sensor input lost, automatically changed sensors.
Remedy: Press the ALARM ACK key. The indication is automatically removed when the signal is restored or a different sensor is selected.				
740	52740,1	EXT RADAR ERROR	Warning Cat: B	Message: "EXT RADAR NO SIGNAL" Meaning: Selected radar has an error. (Only displayed when Interswitch is active.)
Remedy: Press the ALARM ACK key. Restore the external radar to normal operating condition.				
750	52740,2	EXT RADAR ERROR	Warning Cat: B	Message: "EXT RADAR COM ERROR" Meaning: Communication with external radar interrupted or lost. (Only displayed when Interswitch is active.)
Remedy: Press the ALARM ACK key. Check connection and power to the external radar.				
790	52790,1	ARRIVAL	Warning Cat: B	Message: "ARRIVED AT WPT" Meaning: Ship has entered the destination arrival alert zone. Note: This alert appears on C-type radars only.
Remedy: Press the ALARM ACK key. No other action required.				
791	52791,1	XTD LIMIT	Warning Cat: B	Message: "XTD LIMIT EXCEEDED" Meaning: Cross-track error, ship is off-course. Note: This alert appears on C-type radars only.
Remedy: Press the ALARM ACK key. Check course and adjust as necessary.				
-	52001,1	HW STATUS NOTICE	Caution Cat: B	Message: "RPU:FAN1 SPD ERROR" Meaning: FAN1 in the processor unit has low RPM.
Remedy: Press the ALARM ACK key. Have a qualified technician check the fan.				

APPENDIX 3 ALERT CODES, MESSAGES & MEANINGS

ALR Alert ID	ALF Alert ID	Alert title	Priority & Category	Alert description
-	52001,2	HW STATUS NOTICE	Caution Cat: B	Message: "RPU:FAN2 SPD ERROR" Meaning: FAN2 in the processor unit has low RPM.
Remedy: Press the ALARM ACK key. Have a qualified technician check the fan.				
-	52001,3	HW STATUS NOTICE	Caution Cat: B	Message: "RPU:FAN3 SPD ERROR" Meaning: FAN3 in the processor unit has low RPM.
Remedy: Press the ALARM ACK key. Have a qualified technician check the fan.				
-	52001,4	HW STATUS NOTICE	Caution Cat: B	Message: "RPU:HIGH TEMP" Meaning: Temperature in the processor unit is above limit.
Remedy: Press the ALARM ACK key. Lower the temperature.				
-	52001,5	HW STATUS NOTICE	Caution Cat: B	Message: "MONITOR:HIGH TEMP" Meaning: Temperature in the monitor unit is above limit.
Remedy: Press the ALARM ACK key. Lower the temperature.				
-	52001,6	HW STATUS NOTICE*6	Caution Cat: B	Message: "RPU:FAN (RP) SPD ERROR" Meaning: The RPU fan on the RP board, in the processor unit, has low RPM.
Remedy: Press the ALARM ACK key. Have a qualified technician check the fan.				
-	52001,11	HW STATUS NOTICE	Caution Cat: B	Message: "MD TYPE MISMATCH"*3 Meaning: Unable to detect the MD board bandwidth.
Remedy: Press the ALARM ACK key. Check connections to the antenna.				
-	52001,12	HW STATUS NOTICE	Caution Cat: B	Message: "PM TYPE MISMATCH"*3 Meaning: FAN1 in the processor unit has low RPM.
Remedy: Press the ALARM ACK key. Have a qualified technician check the fan.				
-	52001,21	HW STATUS NOTICE	Caution Cat: B	Message: "MTR-DRV:TEMP HIGH" Meaning: MTR-DRV board temperature is above limit.
Remedy: Press the ALARM ACK key. Lower the temperature.				
-	52001,22	HW STATUS NOTICE	Caution Cat: B	Message: "MTR-DRV:OVER CURRENT" Meaning: MTR-DRV board power input from the motor is outside rating.
Remedy: Press the ALARM ACK key. Have a qualified technician check the motor.				
-	52001,23	HW STATUS NOTICE	Caution Cat: B	Message: "MTR-DRV:MOTOR POWER ERROR" Meaning: MTR-DRV board motor's voltage is outside rating.
Remedy: Press the ALARM ACK key. Have a qualified technician check the motor.				
-	52001,24	HW STATUS NOTICE	Caution Cat: B	Message: "MTR-DRV:P12V POWER ERROR" Meaning: Voltage in the +12V line of the MTR-DRV motor is outside rating.
Remedy: Press the ALARM ACK key. Have a qualified technician check the power supply.				

ALR Alert ID	ALF Alert ID	Alert title	Priority & Category	Alert description
-	52001,25	HW STATUS NOTICE	Caution Cat: B	Message: "MTR-DRV:HALL SENSOR ERROR" Meaning: Error in the hall sensor signal detected by the MTR-DRV board.
Remedy: Press the ALARM ACK key. Have a qualified technician check the hall sensor.				
-	52001,26	HW STATUS NOTICE	Caution Cat: B	Message: "MTR-DRV:ANTENNA LOCK" Meaning: Antenna lock detected by the MTR-DRV board.
Remedy: Press the ALARM ACK key. Unlock the antenna.				
-	52001,27	HW STATUS NOTICE	Caution Cat: B	Message: "MTR-DRV:POWER SUPPLY ERROR" Meaning: MTR-DRV board detected an drop in power.
Remedy: Press the ALARM ACK key. Have a qualified technician check the power supply.				
-	52001,28	HW STATUS NOTICE	Caution Cat: B	Message: "MTR-DRV:BRAKE RESISTANCE ERROR" Meaning: MTR-DRV board detected an error in the brake resistance.
Remedy: Press the ALARM ACK key. Have a qualified technician check the antenna brake.				
-	52001,29	HW STATUS NOTICE	Caution Cat: B	Message: "MTR-DRV:OVERLOAD" Meaning: MTR-DRV board detected an overload.
Remedy: Press the ALARM ACK key. Have a qualified technician check the motor.				
-	52001,31	HW STATUS NOTICE	Caution Cat: B	Message: "PM:P12V POWER ERROR" Meaning: Voltage in the +12V line of the PM board is outside rating.
Remedy: Press the ALARM ACK key. Have a qualified technician check the power supply.				
-	52001,32	HW STATUS NOTICE	Caution Cat: B	Message: "PM:PLL UNLOCK" Meaning: PM board's PLL is unlocked.
Remedy: Press the ALARM ACK key. Have a qualified technician check the PM board.				
-	52001,41	HW STATUS NOTICE	Caution Cat: B	Message: "RF-CONV:P6V POWER ERROR"*4 Meaning: Voltage in the +6V line of the RF-Converter is outside rating.
Remedy: Press the ALARM ACK key. Have a qualified technician check the power.				
-	52001,42	HW STATUS NOTICE	Caution Cat: B	Message: "RF-CONV:P48V POWER ERROR"*4 Meaning: Voltage in the +6V line of the RF-Converter is outside rating.
Remedy: Press the ALARM ACK key. Have a qualified technician check the power.				
-	52001,43	HW STATUS NOTICE	Caution Cat: B	Message: "RF-CONV:IF PLL UNLOCK"*4 Meaning: PLL lock on the IF side of the RF-Converter is unlocked.
Remedy: Press the ALARM ACK key. Have a qualified technician check the RF-Converter.				
-	52001,44	HW STATUS NOTICE	Caution Cat: B	Message: "RF-CONV:PLL UNLOCK"*4 Meaning: PLL lock on the RF side of the RF-Converter is unlocked.
Remedy: Press the ALARM ACK key. Have a qualified technician check the RF-Converter.				

APPENDIX 3 ALERT CODES, MESSAGES & MEANINGS

ALR Alert ID	ALF Alert ID	Alert title	Priority & Category	Alert description
-	52001,45	HW STATUS NOTICE	Caution Cat: B	Message: "RF-CONV:OUTPUT SIGNAL LEVEL ERROR" ^{*4} Meaning: Signal output from the RF Converter is outside rating.
Remedy: Press the ALARM ACK key. Have a qualified technician check the RF-Converter.				
-	52001,46	HW STATUS NOTICE	Caution Cat: B	Message: "RF-CONV:INPUT SIGNAL LEVEL ERROR" ^{*4} Meaning: Signal input to the RF Converter is outside rating.
Remedy: Press the ALARM ACK key. Have a qualified technician check the RF-Converter.				
-	52001,47	HW STATUS NOTICE	Caution Cat: B	Message: "HPA:OUTPUT SIGNAL LEVEL ERROR" ^{*4} Meaning: Signal output from the HPA board is outside rating.
Remedy: Press the ALARM ACK key. Have a qualified technician check the HPA board.				
-	52001,48	HW STATUS NOTICE	Caution Cat: B	Message: "HPA:OUTPUT PEAK CURRENT ERROR" ^{*4} Meaning: Peak current detected in the signal output from the HPA board.
Remedy: Press the ALARM ACK key. Have a qualified technician check the HPA board.				
-	52001,52	HW STATUS NOTICE	Caution Cat: B	Message: "VSWR ERROR" ^{*4} Meaning: Abnormal VSWR detected by the RF Converter.
Remedy: Press the ALARM ACK key. Have a qualified technician check the antenna.				
83	52002,01	HW STATUS ERROR	Warning Cat: B	Message: "RPU FAN1 NO ROTATION" Meaning: Fan1 in the processor unit is stopped or disconnected.
Remedy: Press the ALARM ACK key. Have a qualified technician check the processor unit.				
84	52002,02	HW STATUS ERROR	Warning Cat: B	Message: "RPU FAN2 NO ROTATION" Meaning: Fan2 in the processor unit is stopped or disconnected.
Remedy: Press the ALARM ACK key. Have a qualified technician check the processor unit.				
85	52002,03	HW STATUS ERROR	Warning Cat: B	Message: "RPU FAN3 NO ROTATION" ^{*6} Meaning: Fan3 in the processor unit is stopped or disconnected.
Remedy: Press the ALARM ACK key. Have a qualified technician check the processor unit.				
86	52002,04	HW STATUS ERROR ^{*5}	Warning Cat: B	Message: "RPU FAN (RP) NO ROTATION" Meaning: The RPU fan on the RP board, in the processor unit, is stopped or disconnected.
Remedy: Press the ALARM ACK key. Have a qualified technician check the processor unit.				
87	52002,05	HW STATUS ERROR ^{*5}	Warning Cat: B	Message: "RPU RP HW ERROR" ^{*7} Meaning: The RP board has stopped working. Charts and marks cannot be displayed.
Remedy: Press the ALARM ACK key. Have a qualified technician check the processor unit.				

ALR Alert ID	ALF Alert ID	Alert title	Priority & Category	Alert description
-	52729,01	POSN INT ERROR	Caution Cat: B	Message: "POSN INTERVAL ERROR" Meaning: Positioning interval (Lat/Lon) cycle has exceeded 10 seconds for a period of three minutes or more.
Remedy: Press the ALARM ACK key. Check the output settings for the connected EPFS device. Adjust output interval (cycle) as required.				
792	52792,01	CHART ERROR* ⁵	Warning Cat: B	Message: "CHART MEMORY ERROR" Meaning: An error has occurred while loading chart data.
Remedy: Press the ALARM ACK key. Have a qualified technician check the processor unit.				
570	52570,01	LEAVE* ⁵	Warning Cat: B	Message: "DESTINATION LEAVE" Meaning: Your ship has passed beyond the set distance while the [WAYPOINT DEPARTURE ALERT] is active.
Remedy: Press the ALARM ACK key. Check your route and waypoints and steer your vessel accordingly.				
571	52571,01	INTRUSION* ⁵	Warning Cat: B	Message: "INTRUSION BAN" Meaning: Your ship has entered a pre-set "no-go-zone" while the [NO GO ZONE] alert is active.
Remedy: Press the ALARM ACK key. Move your vessel away from the no-go-zone.				
572	52572,01	TEMPERATURE* ⁵	Warning Cat: B	Message: "WATER TEMPERATURE ALERT" Meaning: A change in water temperature was detected that matches the criteria for the [WATER TEMP ALERT].
Remedy: Press the ALARM ACK key. Move your vessel to an area within the alert limits.				
573	52573,01	CURRENT* ⁵	Warning Cat: B	Message: "CURRENT RIP" Meaning: A temperature change was detected that matches the criteria set for [SHEER ALERT].
Remedy: Press the ALARM ACK key. Move your vessel to an area within the alert limits.				

*1: When LOG(WT) is not selected, the alert priority for this alert is changed to "Caution". Caution level alerts are not shown on C-type radars.

*2: When LOG(BT) is not selected, the alert priority for this alert is changed to "Caution". Caution level alerts are not shown on C-type radars.

*3: This alert is output on magnetron radars only.

*4: This alert appears on S-BAND SSD radars only.

*5: This alert is output only on C-types radars.

*6: This alert is output only on S-BAND radars with High Speed Kits installed.

*7: When this alert is rectified, the [Chart] button appears in yellow color. Click the [Chart] button to restore the system to normal operation.

APPENDIX 4 DATA COLOR AND MEANING

Validity and integrity of input data (mode indicator)

Data color	HDG	L/L	SPD	COG/SOG
Normal color (normal data)	THS-A, E HDT	GNS-A, D * ¹ , F, P, R and (NAV status: S, V) GGA-1, 2 * ¹ , 3, 4, 5 GLL-A, D and (status: A) RMC-A, D, F, P, R and (status: A) and (NAV status: S, V)	VBW-A VHW	VTG-A, D, P RMC-A, D, F, P, R and (status: A) and (NAV status: S, V).
Yellow-or- ange color (invalid data)		GNS-E, M, S GGA-6, 7, 8 GLL-E, M, S and (status: A) RMC-E, M, S and (Status: A)		VTG-E, M, S RMC-E, M, S, and (sta- tus: A)
Yellow color (low integrity)		GNS-A, D* ¹ , F, P, R, and (NAV status: C, U) RMC-A, D, F, P, R and (status: A) and (NAV status: C, U)		RMC-A, D, F, P, R and (status: A) and (NAV status: C, U)
***.*	THS-M, V, S	GNS-N GGA-0 RMC-N, (status: V), (NAV status: N) GLL-N, (status: V)	VBW-V	VTG-N RMC-N (sta- tus: V)

*¹: "Age of differential GPS data" in GGA and GNS sentences is ten seconds or higher. In this case, ship's latitude and longitude are displayed in yellow.

APPENDIX 5 ABBREVIATIONS

A:

Abbreviation	Word	Abbreviation	Word
ACK	Acknowledge	ACQ	Acquire
Act	Activate	ACE	Automatic Clutter Elimination
ANT	Antenna	AIS	Automatic Identification System
AP	Autopilot	ATON	Aids to Navigation
AUTO	Automatic	A/C RAIN	Anti Clutter Rain
A/C SEA	Anti Clutter Sea	AID	Aid
ALF	ALF sentence	ALR	Alarm
AMB	Amber	AMS	Alert Management System
APR	April	ARC	Arc
AUG	August		

B:

Abbreviation	Word	Abbreviation	Word
BLU	Blue	BCR	Bow Crossing Range
BCT	Bow Crossing Time	BRG	Bearing
BRILL	Brilliance	BT	Bottom Tracking

C:

Abbreviation	Word	Abbreviation	Word
CALC	Calculated	CALIB	Calibrate
CH	Channel	CHG	Change
CCRP	Consistent Common Reference Point	CONT	Continue
CPA	Closest Point of Approach	CORR	Corrected/Correction
CPU	Central Processing Unit	CRS	Course
CTW	Course Through the Water	COG	Course Over Ground
CU	Course Up	CYA	Cyan

D:

Abbreviation	Word	Abbreviation	Word
DTM	Datum	DEC	December
deg	degree(s)	DEST	Destination
DGPS	Differential GPS	DISP	Display
DIST	Distance	DR	Dead Reckoning

APPENDIX 5 ABBREVIATIONS

E:

Abbreviation	Word	Abbreviation	Word
E	East	EAV	Echo Averaging
EBL	Electronic Bearing Line	EBRL	Electronic Bearing Range Line
ECDIS	Electronic Chart Display and Information System	EP	Estimated Position
EQUIP	Equipment	ERR	Error
ES	Echo Stretch	ETA	Estimated Time of Arrival
ETD	Estimated Time of Departure	EXT	External

F:

Abbreviation	Word	Abbreviation	Word
FEB	February	FILT	Filter/Filtered
FUNC	Function		

G:

Abbreviation	Word	Abbreviation	Word
GAP	Gap	GC	Great Circle
GND	Ground	GMDSS	Global Maritime Distress and Safety System
GPS	Global Positioning System	GRAD	Gradation
GRN	Green	GRY	Gray
GT	Gross Tonnage		

H:

Abbreviation	Word	Abbreviation	Word
HD	Heading	HDG	Heading
HL	Heading Line	HSC	High Speed Craft

I:

Abbreviation	Word	Abbreviation	Word
IBS	Integrated Bridge System	ID	Identification
IMO	International Maritime Organization	INT	Interval
INS	Integrated Navigation System	INFO	Information
IR	Interference Rejection	IP ADDRESS	Internet Protocol Address

J:

Abbreviation	Word	Abbreviation	Word
JAN	January	JUN	June
JUL	July		

L:

Abbreviation	Word	Abbreviation	Word
L	Long pulse	LAT	Latitude
LAN	Local Area Network	LCD	Liquid Crystal Display
LIM	Limit	L/L	Latitude/Longitude
LOG	Log	LON	Longitude
LOP	Line Of Position		

M:

Abbreviation	Word	Abbreviation	Word
MAG	Magnetic	MAG	Magenta
MAN	Manual	MAR	March
MAX	Maximum	MAY	May
MBS	Main Bang Suppression	M-CYA	Multi Cyan
MD	Modulator	MENU	Menu
MFDF	Medium Frequency Direction Finder	MIC	Monolithic Integrated Circuit
M-GRN	Multi Green	M1	Medium pulse 1
MID	Middle	M3	Medium pulse 3
M2	Medium pulse 2	MON	Monday
MOB	Man Over Board	MSC	Maritime Safety Committee
Msgs	Messages	MTR-DRV	Motor Drive

N:

Abbreviation	Word	Abbreviation	Word
N	North	NAV	Navigation
NLT	Not Less Than	NMT	Not More Than
NOV	November	NR	Noise Rejector

O:

Abbreviation	Word	Abbreviation	Word
OS	Own Ship	OCT	October

P:

Abbreviation	Word	Abbreviation	Word
PAST POSN	Past Positions	PC	Personal Computer
PI	Parallel Index Line	PLT	Palette
PLL	Phase Locked loop	PM	Performance Monitor
PNK	Pink	POSN	Position
PPI	Plan Position Indicator		

APPENDIX 5 ABBREVIATIONS

R:

Abbreviation	Word	Abbreviation	Word
RACON	Radar beacon	RAD	Radius
RAM	Random Access Memory	RAIN	Anti Clutter Rain
RD	Read	RED	Red
REF	Reference/Echo Reference	R, REL	Relative
REJ	Rejection	RENC	Regional ENC Co-ordinating Centre
RFC board	RF Control board	RL	Rhumb Line
RM	Relative Motion	RNG	Range
ROM	Read Only Memory	ROT	Rate Of Turn
RTE	Route	RTGT	Reference Target
RX	Receive		

S:

Abbreviation	Word	Abbreviation	Word
S	South	S1	Short pulse1
S2	Short pulse2	S57	IHO Special Publication 57
SAR	Search and Rescue	SART	Search and Rescue Transponder
SD	Secure Digital	SEA	Anti Clutter Sea
SEL	Select	SENC	System ENC
SEP	September	SIO	Serial Input Output
SOG	Speed Over Ground	SOLAS	Safety of Life at Sea
SPD	Speed	SPU	Signal Processing Unit board
STAB	Stabilized	STBD	Starboard
STBY	Standby	STC	Sensitivity time control
Std	Standard	STW	Speed Through Water
SW	Switch	SYM	Symbol
Symb	Symbol(s)		

T:

Abbreviation	Word	Abbreviation	Word
T	True	TAG	Tag
TCPA	Time to CPA	TGT	Target
TM	True Motion	TPL	Transferred Line Of Position
True-G	True ground stabilized	True-S	True sea stabilized
TT	Target Tracking/Tracked Target	TTG	Time To Go
TX	Transmit		

U:

Abbreviation	Word	Abbreviation	Word
UNCAL	Uncalibrated	UTC	Coordinated Universal Time

V:

Abbreviation	Word	Abbreviation	Word
VECT	Vector	VRM	Variable Range Marker

W:

Abbreviation	Word	Abbreviation	Word
W	West	WAT	Water
WGS	World Geodetic System	WHT	White
W/O	Without	WOP	Wheel Over Point
WP	Waypoint	WPT	Waypoint
WR	Write	WT	Water Tracking
WTC	Water Tracking Current		

X:

Abbreviation	Word
XTE	Cross Track Error

Y:

Abbreviation	Word
YEL	Yellow

















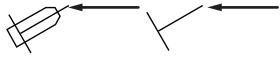
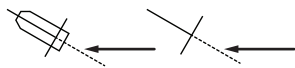

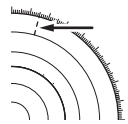

Units of measurement



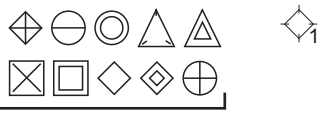



Unit abbreviation	Meaning	Unit abbreviation	Meaning
deg	Degree(s)	ft	Foot/feet
H	Hour(s)	km	Kilometer(s)
KM	Kilometer(s)	kn	Knot(s)
KYD	Kiloyard(s)	min	Minute(s)
m	Meter(s)	MHz	Megahertz
NM	Nautical miles	sec	Second(s)
SM	Statute mile(s)	°	Degree(s)

APPENDIX 6 SYMBOLS



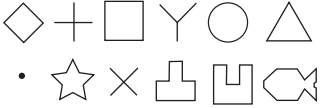

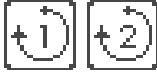











The pages following list the symbols which appear on your radar.

General symbols











Symbol/Icon	Name/Meaning
 (on power switch)	Power Symbol
 	Own Ship Marker. Appears at the CCRP location as either a scaled symbol (left figure) or minimized symbol (right figure).
 	Own Ship Marker (shown when plotting track). Appears at CCRP location as a filled circle (plotting is on), or double circle (plotting is paused or off).
	Antenna mark. Indicates the location of your antenna and appears only when ship symbol is scaled.
	Heading line. Appears at the CCRP location and indicates your current heading.
	Stern line. Appears at the CCRP location and indicates your current stern direction.
	Fixed Range Rings. Appear with the CCRP location as the center and allow you to estimate range.
VRM 1  VRM 2	Variable Range Markers. Appear with the CCRP as the center* ¹ and allow for range measurement. The dashed line length for each VRM is different.
EBL2  EBL1 EBRL markers (range)	Electronic Bearing Lines. Indicate bearing. Shown as a dashed line with different line length from the heading line and each other. The small line that intersects the EBL is the EBRL, used for measuring range.
	North mark. Indicates the NORTH direction. Appears a thin dotted line at the edge of the operational display area.
	Cursor. Indicates the cursor location.
	Barge Icon. Indicates the barge location.
	Drop Mark. Appears at the location a drop mark is entered. Range and bearing from OS to the drop mark appear on-screen.
 IMO-types only	Origin Marks For numbered origin marks, number availability depends on your radar type. IMO-types: 1 to 10; C-types: 1 to 40
 	MOB (Man Over Board) Marks Left: C-types; Right: IMO-types
  	Chart status (C-types only) Left: Chart scale displayed correctly; Center: Chart scale displayed incorrectly; Right: There is no chart file.

Symbol/Icon	Name/Meaning
	Other ship marks Left: consort ship; right: GPS buoy
<p>IMO-types</p>  <p>C-types</p> 	Waypoint marks
	Marks (C-types only)
	Hold icon (C-types only) Indicates that track plotting is stopped (on-hold).
	Recording interval icon (C-types only) Indicates the track recording interval in use.
	"Save" icon (C-types only) Indicates that the current voyage is being saved as a route.
	"Save" floppy disc icon (C-types only) Indicates that the current customized settings are not saved.

Radar map symbols (IMO type)





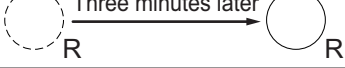









Symbol	Name	Symbol	Name
 Red	Buoy	 Orange	Mark
 Green	Buoy	 Orange	Mark
 Red	Buoy	 Orange	Mark
 Green	Buoy	 Magenta	Navline (map)
 Red	Buoy	 White	Coastline
 Green	Buoy	 Gray	Contour Line
 Red	Buoy	 Magenta	Danger Highlight
 Green	Buoy	 Magenta (cable)	Danger Highlight
 Magenta	Danger Highlight	 Orange	Mark
 Magenta	Danger Highlight	 Orange	Mark

TT/AIS symbols



























TT symbols	
Symbol	Name
	Manually acquired target. Appears as a dashed circle at initial acquisition, changes to solid circle when tracking is stable.
	Automatically acquired target. Appears as a dashed red circle at initial acquisition, changes to solid circle when tracking is stable.
	Vector on acquired target (approx. 1 minute after acquisition)
	Stable tracking on acquired target (approx. 3 minute after acquisition)
	Dangerous target. Symbol flashes in red color to indicate that this target may be on a collision course with your vessel.
	Associated TT target. Appears when the target is associated and TT is given priority.
	Associated dangerous TT target. Appears in red color when the target is associated, TT is given priority and the target may be on a collision course with your vessel.
	Lost TT target. Indicates that this target is lost and is no longer being tracked. Appears as a flashing symbol with a red colored "X".
	Acquisition zone target. Appears when a target is acquired by the acquisition zone. Target symbol flashes in red color.
	Selected target. Indicates that the target is selected for data display (range, bearing, speed, etc.).
	Reference target. Indicates that this target is selected as a reference point for speed calculations.
T	Trial maneuver indication (IMO-types only)
S	TT simulation mode indication

Note: For C-types, you can change the TT symbol shape to one of the following symbols. You can also change the color of the selected symbol.



AIS symbols	
Symbol	Name
	Activated AIS target. Appears a thick-lined symbol. Color is selectable from the menu.
	Activated AIS target with vector. Indicates the target's ROT (Rate Of Turn). Vector appears when the target's ROT is higher than the menu setting.
	Dangerous AIS target. Flashing red symbol indicates that the target matches then CPA/TCPA criteria. Symbol stops flashing after the alert is acknowledged.
	Lost AIS target. Indicates that this target is lost and is no longer being tracked. Appears as a flashing symbol with a red colored "X" until the alert is acknowledged.
	Sleeping AIS target. Color is selectable from the menu.
	AIS target with no heading/COG data. Symbol faces the top of the screen. Furthermore, if CPA/TCPA cannot be calculated, symbol appears as a dashed line.
	AIS target selected for data display. Location of data display in the information box is indicated below the target as "A", "B" or "C".
	Associated AIS target. Appears when the target is associated and AIS is given priority.
	Dangerous associated AIS target. Appears in red color when the target is associated, AIS is given priority and the target may be on a collision course with your vessel.
	Active AIS target with scaled ship symbol. Indicates the target vessel's dimensions (length, width, antenna location) and changes on-screen size according to display range.
	AIS SART (TEST)
	AIS SART (ACTIVE)
	AIS Base station
	AIS Aircraft. Note: AIS aircraft are not regarded as a collision hazard. CPA and TCPA for AIS aircraft appears as "****".
	AIS Search and Rescue (SAR) Vessel

APPENDIX 6 SYMBOLS

AIS Physical AtoN Symbol	AIS Virtual AtoN Symbol	Meaning
		Basic shape
	No virtual symbol	RACON
		Emergency wreck mark
		North cardinal mark
		East cardinal mark
		South cardinal mark
		West cardinal mark
		Port hand mark
		Starboard hand mark
		Isolated danger
		Safe water
		Special mark
Off Posn 	No virtual symbol	Off position (Displayed with yellow line and yellow text)
Unlit 	No virtual symbol	Light fail or at reduced range (Displayed with yellow text)
Racon err 	No virtual symbol	RACON error (Displayed with yellow text)
No physical symbol	Missing 	Missing (Displayed with yellow dashed line and yellow text)

APPENDIX 7 PARTS LOCATION

Control Unit RCU-014

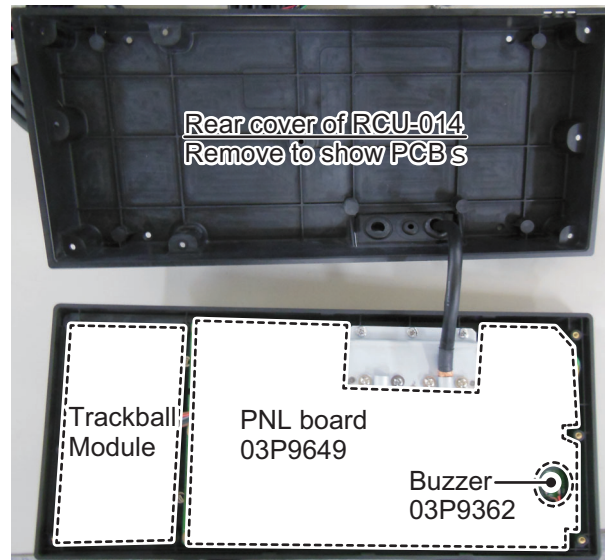

Control unit RCU-015/RCU-016

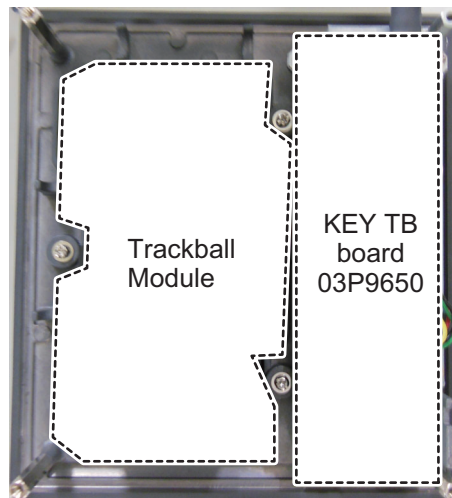

Control Unit RCU-031

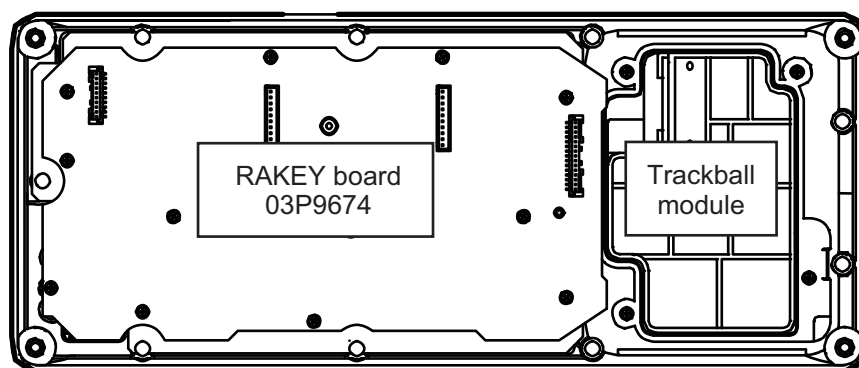

Processor Unit RPU-025

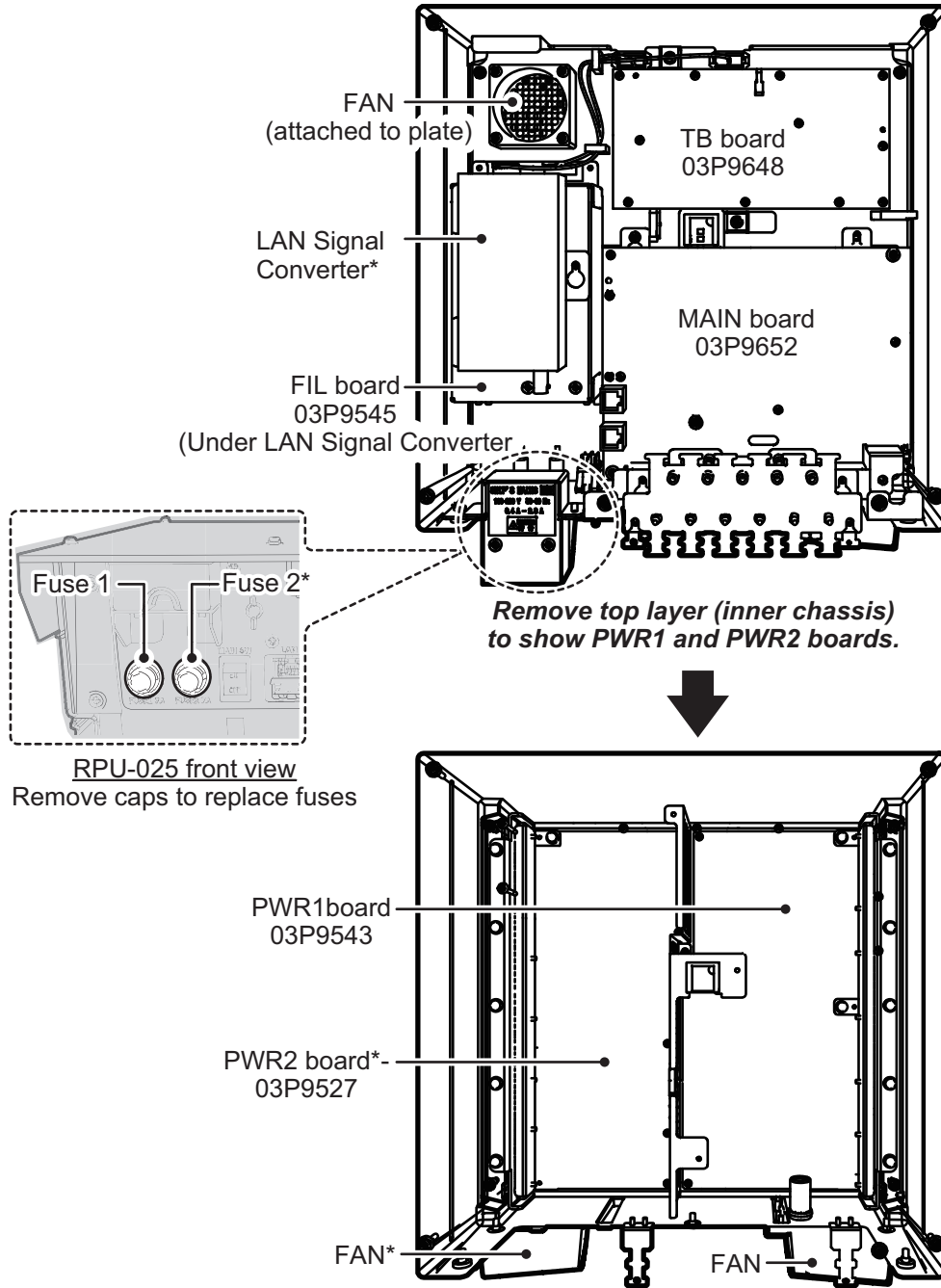

Remove top layer (inner chassis) to show PWR1 and PWR2 boards.

*: The presence of this component depends on configuration purchased.

Scanner Unit RSB-128 (FAR-2218(-BB), FAR-2318, FAR-2228(-BB), FAR-2328)

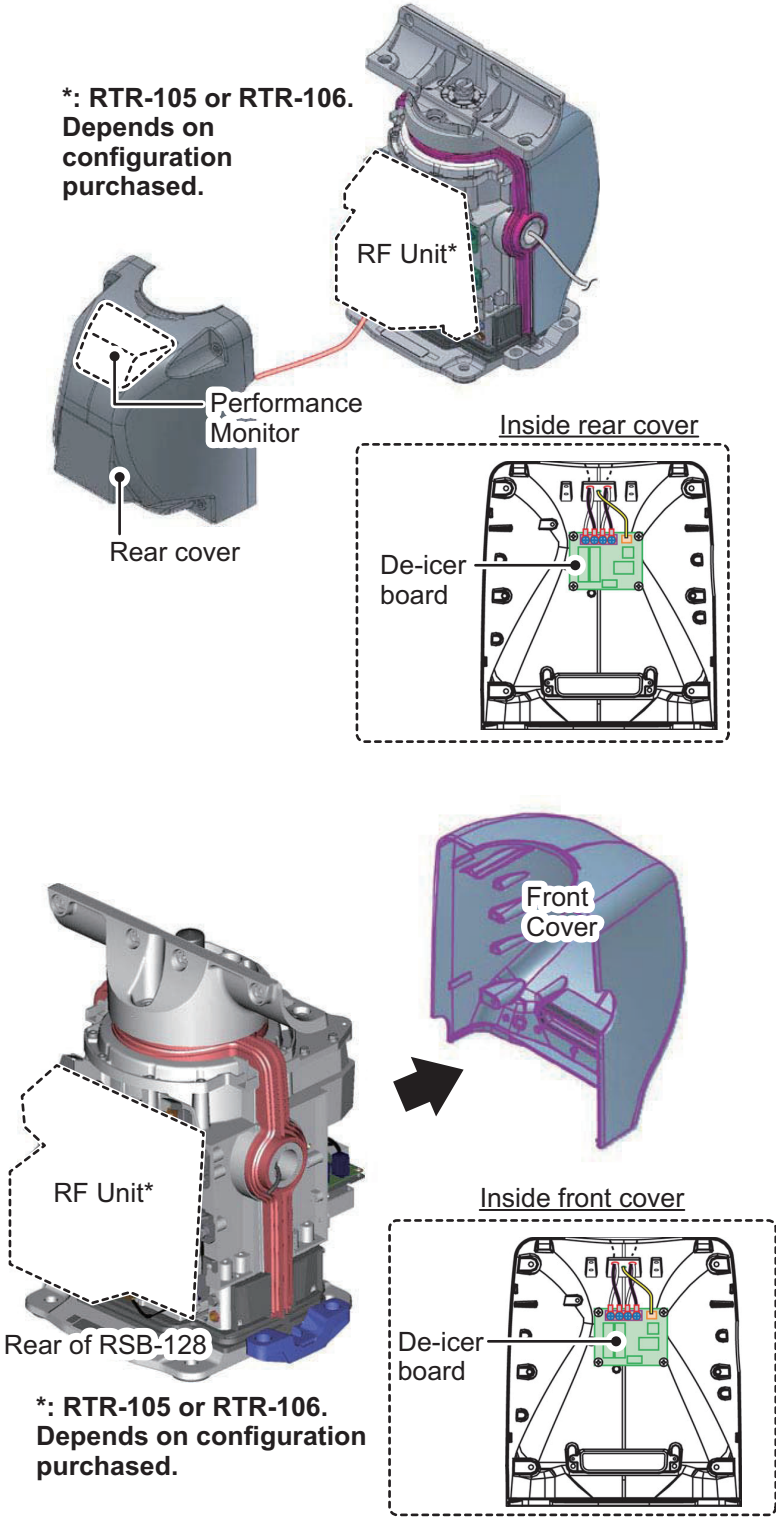

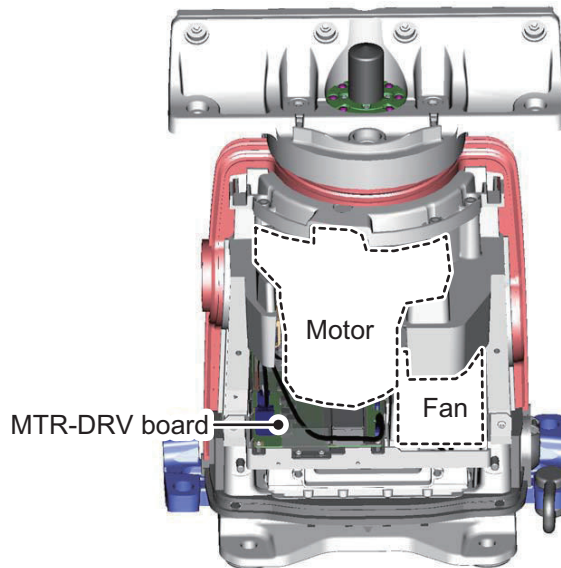

Front view of RSB-128
(front cover removed)

RF Unit RTR-105/106 (FAR-2218(-BB), FAR-2318, FAR-2228(-BB), FAR-2328)

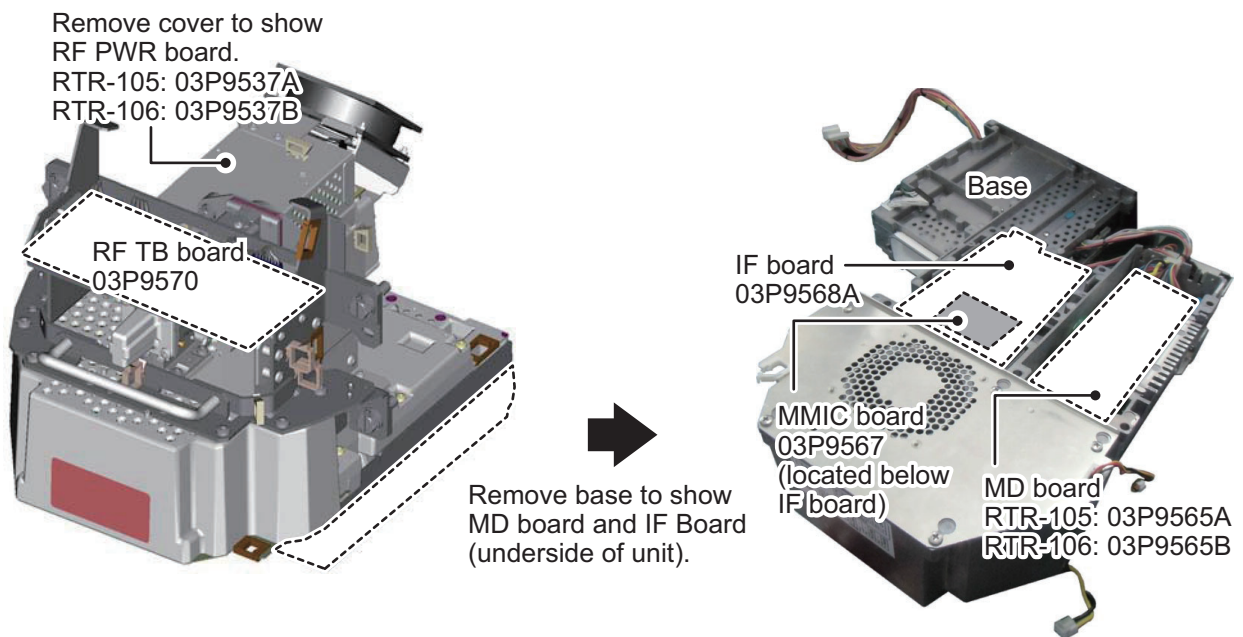

Scanner Unit RSB-129 (FAR-2238S(-BB), FAR-2338S)

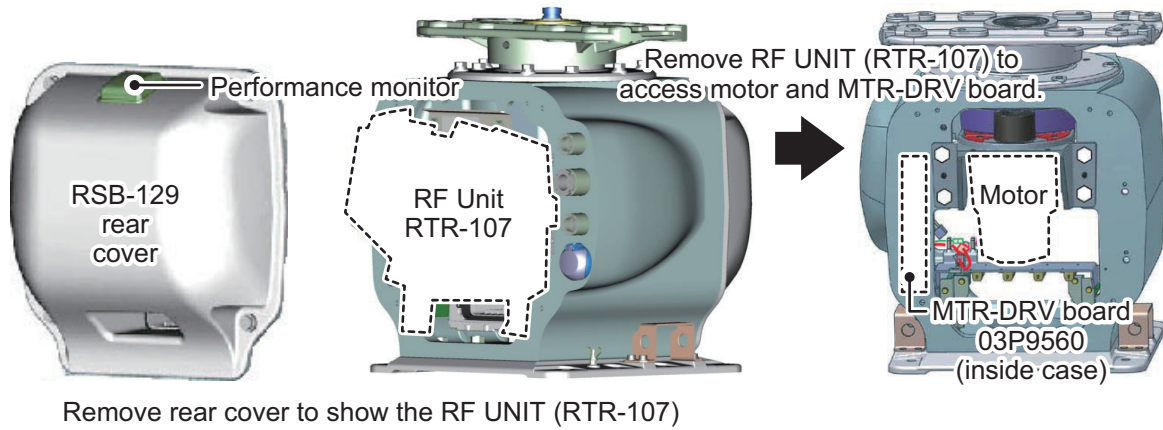

RF Unit RTR-107 (FAR-2238S(-BB), FAR-2338S)

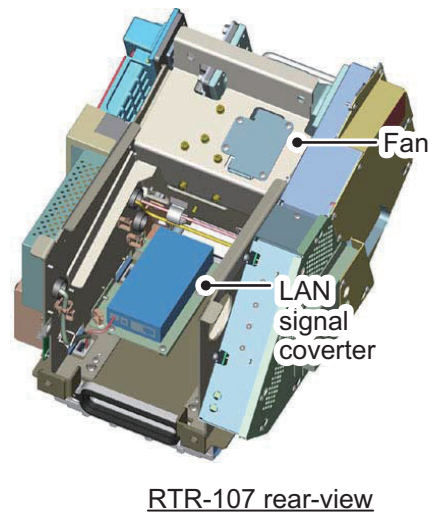
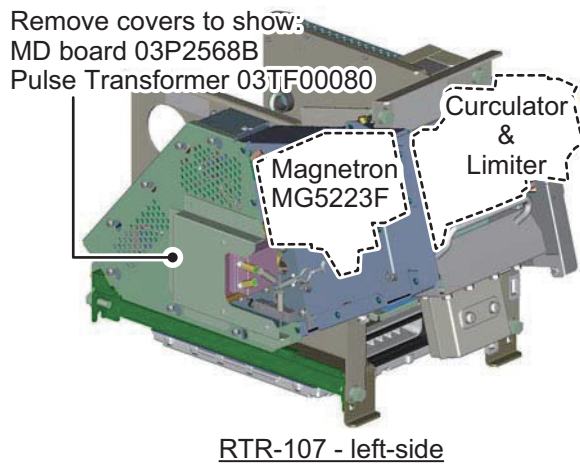
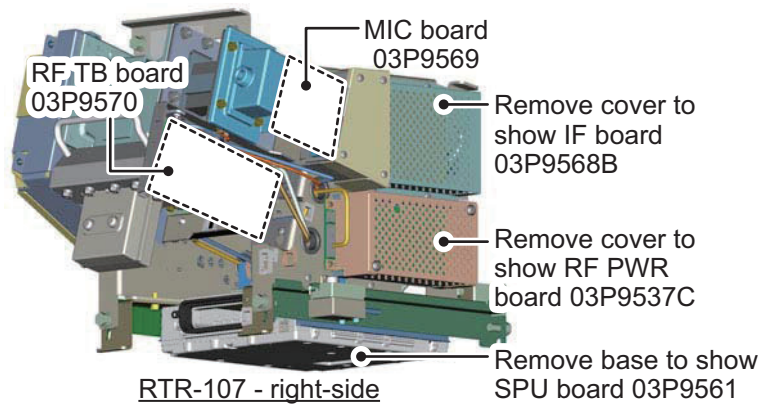

Scanner Unit RSB-133 (FAR-2238S-NXT(-BB)/2338S-NXT)

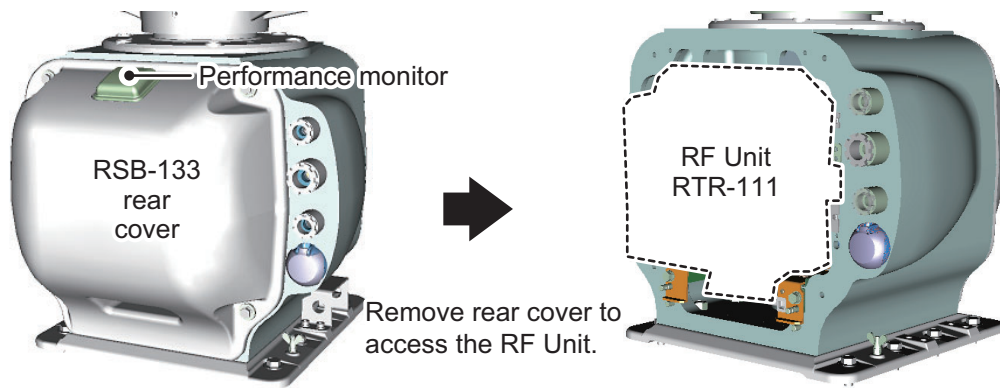

RF Unit RTR-111 (FAR-2238S-NXT(-BB)/2338S-NXT)

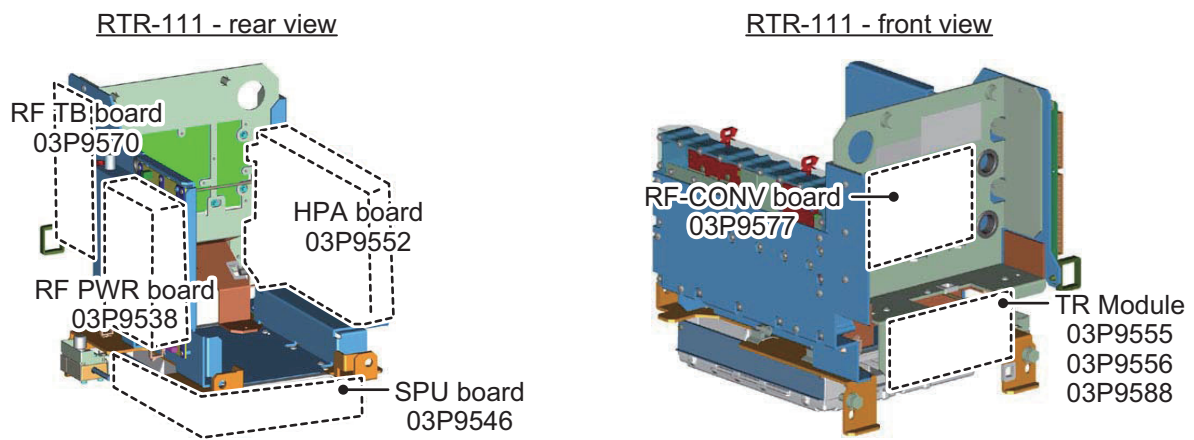

Scanner Unit RSB-139 (FAR-2258/FAR-2358)

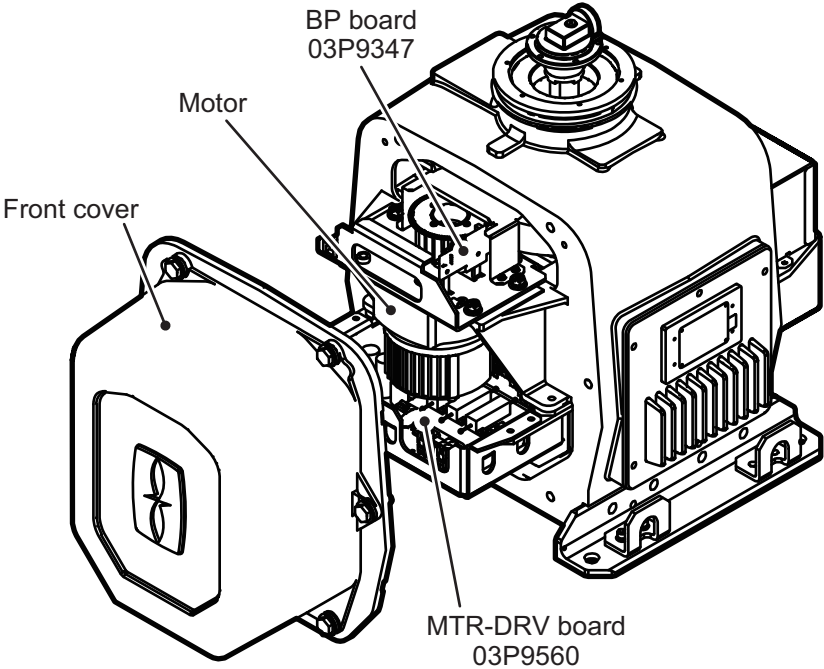
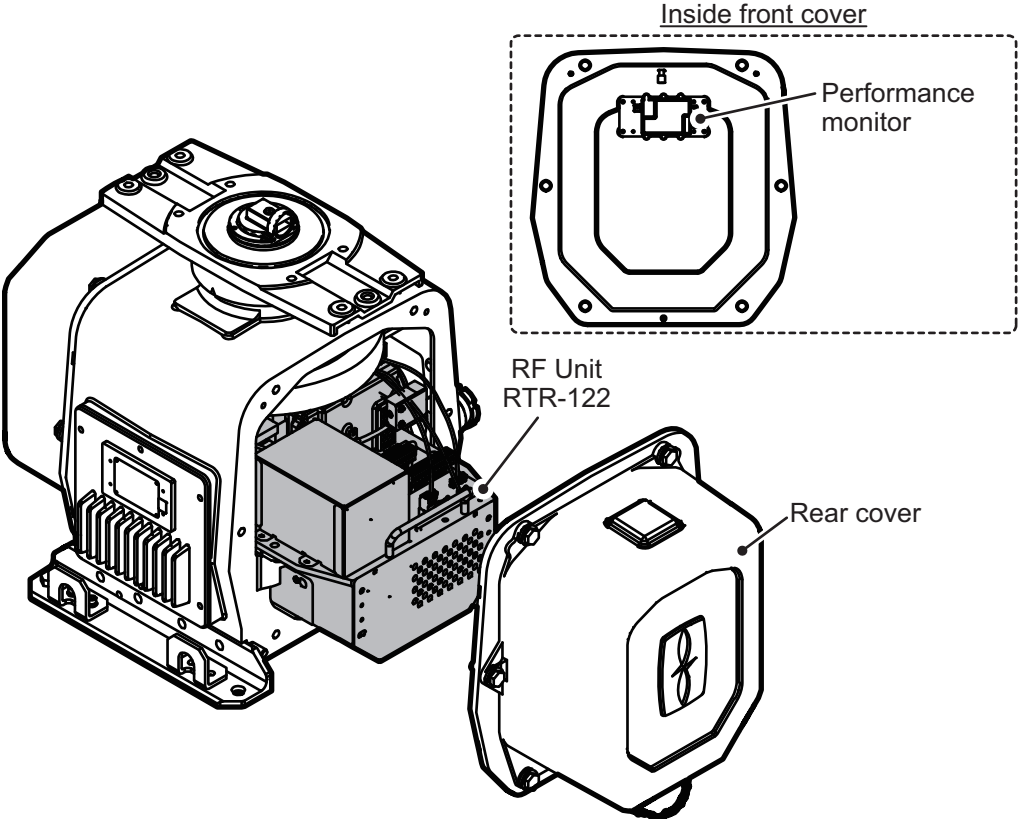

RF Unit RTR-122 (FAR-2258/FAR-2358)

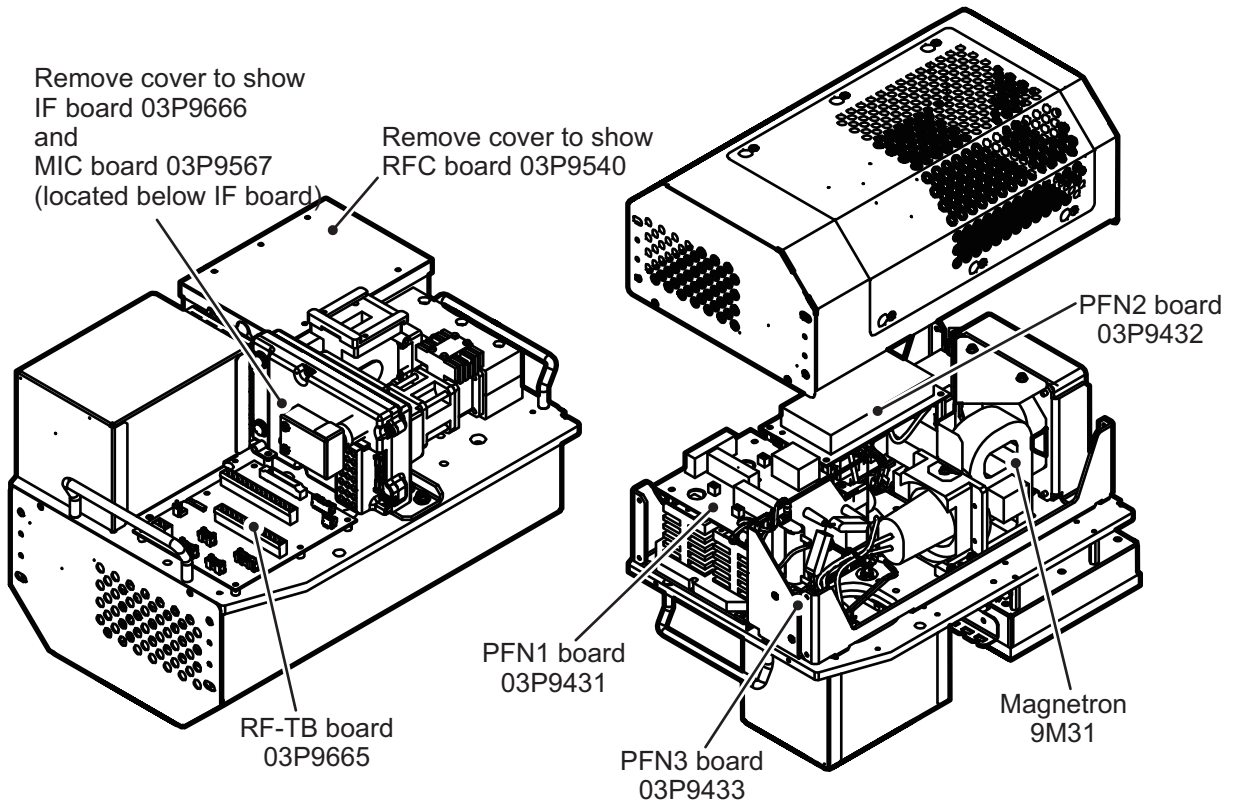

Power Supply Unit PSU-019

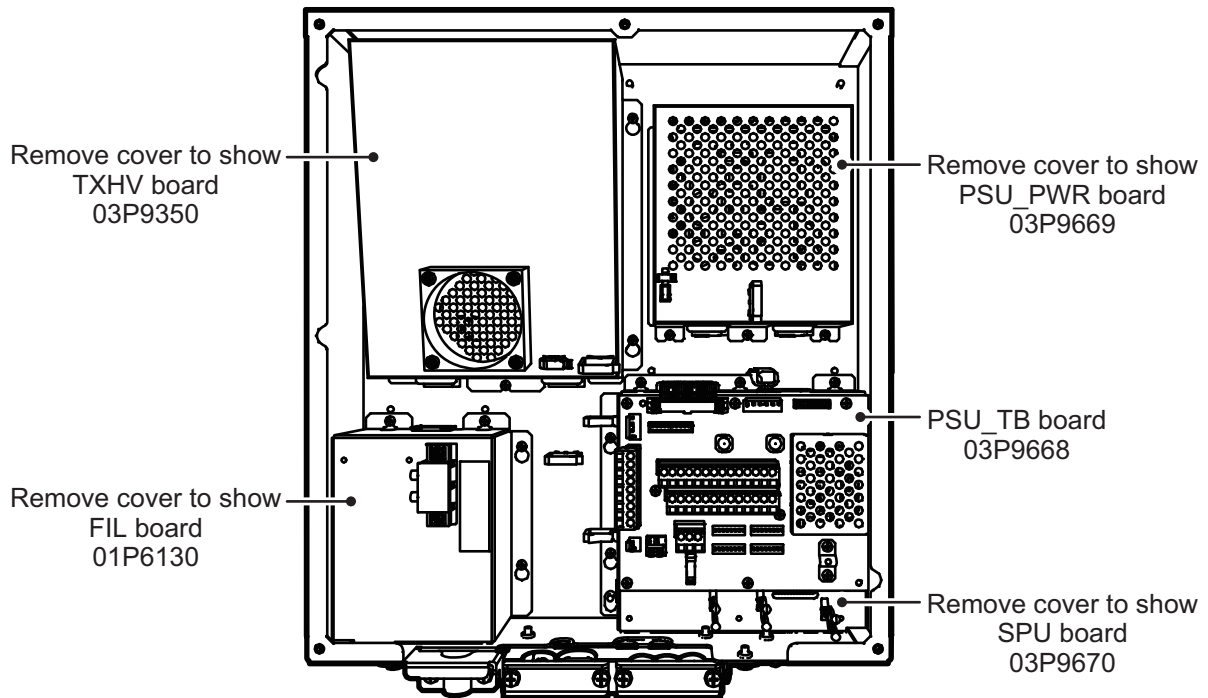

APPENDIX 8 RADIO REGULATORY INFORMATION

USA-Federal Communications Commission (FCC)

This device complies with part 15 of the FCC Rules. Operation is subject to the following two conditions:

- (1) This device may not cause harmful interference, and
- (2) This device must accept any interference received, including interference that may cause undesired operation. Any changes or modifications not expressly approved by the party responsible for compliance could void the user's authority to operate the equipment.

Caution: Exposure to Radio Frequency Radiation

- This equipment complies with FCC radiation exposure limits set forth for an uncontrolled environment and meets the FCC radio frequency (RF) Exposure Guidelines in Supplement C to OET65.
- This equipment should be installed and operated keeping the radiator at least XX cm or more away from person's body.
- This device must not be co-located or operating in conjunction with any other antenna or transmitter.

Innovation, Science and Economic Development Canada (ISED)

This device contains licence-exempt transmitter(s)/receiver(s) that comply with Innovation, Science and Economic Development Canada's licence-exempt RSS(s). Operation is subject to the following two conditions:

- (1) This device may not cause interference.
- (2) This device must accept any interference, including interference that may cause undesired operation of the device.

Cet appareil contient un ou plusieurs émetteurs / récepteurs exempts de licence qui sont conformes à la norme « exempts de licence RSS (s) » Canadienne d'Innovation, Sciences et Développement économique. L'exploitation est autorisée aux deux conditions suivantes:

- (1) l'appareil ne doit pas produire de brouillage.
- (2) l'utilisateur de l'appareil doit accepter tout brouillage radioélectrique subi, même si le brouillage est susceptible d'en compromettre le fonctionnement.

Caution: Exposure to Radio Frequency Radiation

This equipment complies with ISED radiation exposure limits set forth for an uncontrolled environment and meets RSS-102 of the ISED radio frequency (RF) Exposure rules. This equipment should be installed and operated keeping the radiator at least XX cm or more away from person's body.

Cet équipement est conforme aux limites d'exposition aux rayonnements énoncées pour un environnement non contrôlé et respecte les règles d'exposition aux fréquences radioélectriques (RF) CNR-102 de l'ISED. Cet équipement doit être installé et utilisé en gardant une distance de XX cm ou plus entre le dispositif rayonnant et le corps.

To reduce potential radio interference to other users, the antenna type and its gain should be so chosen that the equivalent isotropically radiated power (EIRP) is not more than that required for successful communication.

XX cm

FAR-2258	RTR-122	1390 cm	FAR-2238S	RTR-107	460 cm
FAR-2358			FAR-2338S		
FAR-2218	RTR-105	440 cm	FAR-2238S-NXT	RTR-111	100 cm
FAR-2318			FAR-2338-NXT		
FAR-2228	RTR-106	950 cm			
FAR-2328					

**SPECIFICATIONS OF MARINE RADAR
FAR-2xx8 SERIES (Fishing)**

1 ANTENNA RADIATOR

1.1 Type Slotted waveguide array

1.2 Beam width and sidelobe attenuation

Radiator type	X-band			S-band		
	XN12CF	XN20CF	XN24CF**	SN24CF*	SN30CF*	SN36CF
Length	4 ft	6.5 ft	8 ft	8 ft	10 ft	12 ft
Horizontal beam width	1.9°	1.23°	0.95°	2.6°	2.3°	1.8°
Vertical beam width	20°			25°		
Sidelobe within ±10°	-24 dB	-28 dB	-28 dB	-		-24 dB
Sidelobe outside ±10°	-30 dB	-32 dB	-32 dB	-		-30 dB
Sidelobe within ±20°	-			-23 dB	-24 dB	-
Sidelobe outside ±20°	-			-27 dB	-30 dB	-

*: C-type radar only. **: 24 rpm only.

- 1.3 Polarization Horizontal
- 1.4 Rotation 24 rpm or 42 rpm (for high speed craft)
- 1.5 Wind load 100 kn relative
- 1.6 De-icer (option) On: when temperature goes down to 0°C
Off: when temperature goes up to +5°C

2 TRANSCEIVER

2.1 TX Frequency and modulation

- X-band (Magnetron) 9410 MHz ±30 MHz, P0N
- S-band (Magnetron) 3050 MHz ±30 MHz, P0N
- S-band (Solid state) CH1 P0N: 3043.75 MHz/ Q0N: 3063.75 MHz ±5 MHz or
CH2 P0N: 3053.75 MHz/ Q0N: 3073.75 MHz ±5 MHz

2.2 Output power

- FAR-2218(BB)/2318 12 kW
- FAR-2228(BB)/2328 25 kW
- FAR-2238S(BB)/2338S 30 kW
- FAR-2238S-NXT(BB)/2338S-NXT 250 W (equivalent to magnetron radar 30 kW)

2.3 Range scale, Pulse Repetition Rate and Pulselength

Magnetron radar: FAR-2218(BB)/2318/2228(BB)/2328/2238S (BB)/2338S

PRR (Hz approx.)	Range scale (NM)																	
	0.125	0.25	0.5	0.75	1	1.5	2	3	4	6	8	12	16	24	32	48	96	
3000*	S1																	
3000*		S2																
1500			M1															
1200				M2														
1000					M3													
600**									L									

1/2/4/8/16/32 NM ranges: C-type radar only

*: 2200 Hz with TT range on 32 NM. **: 500 Hz on 96 NM range.

Solid state radar: FAR-2238S-NXT(BB)/2338S-NXT

PRR (Hz approx.)	Range scale (NM)																
	0.125	0.25	0.5	0.75	1	1.5	2	3	4	6	8	12	16	24	32	48	96
2400*	S1																
2000*			S2														
1500			M1														
1060					M2												
1000							M3										
600									L								

1/2/4/8/16/32 NM ranges: C-type radar only

*: 1800 Hz (S1) and 1500 Hz (S2) with TT range on 32 NM.

3 PROCESSOR UNIT

- 3.1 Minimum range 22 m
- 3.2 Range discrimination 26 m
- 3.3 Range accuracy 1% of the maximum range of the scale in use or 10 m, whichever is the greater
- 3.4 Bearing discrimination
X-band: 2.1° (XN12CF), 1.5° (XN20CF), 1.2° (XN24CF),
S-band: 2.8° (SN24CF), 2.5° (SN30CF), 2.0° (SN36CF)
- 3.5 Bearing accuracy ±1°
- 3.6 Range scale and Range ring interval (RI)

Range (NM)	0.125	0.25	0.5	0.75	1	1.5	2	3	4	6	8	12	16	24	32	48	96
RI (NM)*	0.025	0.05	0.1	0.25	0.25	0.25	0.5	0.5	1	1	2	2	4	4	8	8	16
Number of rings*	5	5	5	3	4	6	4	6	4	6	4	6	4	6	4	6	6

1/2/4/8/16/32 NM ranges: C-type radar only.

*: changeable from menu for C-type radar.

- 3.7 Warm-up time 3 min. approx. (solid state radar excluded)
- 3.8 Presentation mode Head-up, STAB head-up, Course-up, North-up (RM/TM), Stern-up
- 3.9 Marks Cursor, Range ring, Heading mark, North mark, Bearing mark, VRM, EBL, Acquisition zone
- 3.10 Target tracking (TT) Auto or manual acquisition: 100 targets in 24/32 NM (range selected from menu for maintenance)
Auto tracking on all acquired targets,
Tracking: 5/10 pts on all activated targets
Vector time: Off, 30 s, 1-60 min
- 3.11 AIS Display capacity: 350 targets,
Tracking: 5/10 pts on all activated targets
Vector time: Off, 30 s, 1-60 min
- 3.12 Echo trail True/Relative, Trail length: 0 to 30 minutes (30 s steps) or continue, Maximum 48 hours setting available for C-type radar
- 3.13 Radar map 20,000 pts
- 3.14 Acquisition zone 2 zones

4 PLOTTER FUNCTIONS (for C-type Radar)

- 4.1 Projection Mercator
- 4.2 Useable area 85° latitude or below

- 4.3 Effective projection area 0.025 to 120 NM (for STBY),
follows the radar range scale while transmitting
- 4.4 Memory capacity
 - Own ship's track 30,000 pts (10,000 pts indicated)
 - Other ship's track TT: 100,000 pts (10,000), AIS: 10,000 pts (10,000),
consort ship: 10,000 pts (1,000), GPS buoy: 10,000 pts (1,000)
(): indicated pts
 - Mark/line 30,000 pts
 - Waypoint 3,500 pts
 - Route 200 routes with 100 waypoint each
- 4.5 External memory Waypoint: 100 pts, 1 route
- 4.6 Electronic chart Mapmedia
- 4.7 Own ship's tracking 7 colors

5 MONITOR UNIT

- 5.1 Screen type
 - MU-190 19-inch color LCD, 1280 x 1024 (SXGA)
 - MU-231 23.1-inch color LCD, 1600 x 1200 (UXGA)
 - MU-270W 27-inch color LCD, 1920 x 1200 (WUXGA)
- 5.2 Brightness
 - MU-190 450 cd/m² typical
 - MU-231/270W 400 cd/m² typical
- 5.3 Visible distance
 - MU-190/270W 1.02 m nominal
 - MU-231 1.2 m nominal
- 5.4 Radar effective diameter
 - MU-190 282 mm
 - MU-231 331 mm
 - MU-270W 349 mm

6 INTERFACE

- 6.1 Number of port (processor unit)
 - Serial 7 ports (IEC61162-1/2: 2 ports, IEC61162-1: 4 ports, AD-10: 1 port)
 - Alarm output 6 ports: contact signal, load current 250mA
(Normal close/ open: 4, System fail: 1, Power fail: 1)
 - DVI output 2 ports: DVI-D, DVI-I or RGB picture data (for VDR)
(RGB resolution 1280x1024 (SXGA), 60.0Hz or
1440x900 (WXGA+), 59.9Hz)
 - LAN 2 ports: Ethernet 100Base-TX
 - USB 2 ports: USB flash memory and mouse/keypad
 - RS-232C 1 port: brilliance control
 - Sub display (for ECDIS) 2 ports: HD, BP, Trigger and Video signal
- 6.2 Data sentences (IEC61162-1/2)
 - Input ABK, ACK, ACN, ALR, BWC, BWR, CUR, DBK*¹, DBS*¹, DBT,
DDC, DPT, DTM, GGA, GLL, GNS, HBT, HDG, HDM, HDT*¹, MTW,

Output MWV, OSD, RAQ, RMB, RMC, ROT, RTE, THS, TLL, TTM, VBW, VDM, VDO, VDR, VHW, VSD, VTG, VWR*¹, VWT*¹, WPL, ZDA ABM, ACK, AIQ, ALC, ALF, ALR, ARC, BBM, DDC, EVE, HBT, OSD, RSD, TLB, TLL*², TTD, TTM, VSD
*¹: for retrofit. *²: for C-type radar

6.3 Ethernet interface for IEC61162-450

Port (LAN2) 100Base-TX, IPv4, 8P8C connector

Data sentences Same as 6.2 sentences

IEC61162-450 transmission group

Input MISC, TGTD, SATD, NAVD, TIME, PROP

Output Arbitrary (default: TGTD)

Multicast address 239.192.0.1 to 239.192.0.16

Destination port 60001 to 60016

Re-transmittable binary image transfer

Multicast address 239.192.0.26 to 239.192.0.30

Destination port 60026 to 60030

Other network function excepted IEC61162-450

SNMP, HTTP, Syslog, Furuno Management Protocol (FMP)

6.4 Output port on antenna unit

Sub display (for radar/plotter) 1 port: HD, BP, Trigger and Video signal

7 POWER SUPPLY

7.1 Processor unit (w/ antenna unit)

FAR-2218/2318 100-230 VAC: 2.1-1.0 (2.9-1.3) A, 1 phase, 50-60 Hz or 24 VDC (21.6-31.2V): 5.4 A (9.0 A)

FAR-2228/2328 100-230 VAC: 2.3-1.1 (3.2-1.4) A, 1 phase, 50-60 Hz or 24 VDC (21.6-31.2V): 8.9 A (12.4 A)

FAR-2238S/2338S 100-230 VAC: 3.2-1.5 (5.6-2.5) A, 1 phase, 50-60 Hz

FAR-2238S-NXT/2338S-NXT 100-230 VAC: 2.6-1.2 (5.1-2.2) A, 1 phase, 50-60 Hz (): 42 rpm

7.2 Monitor unit

MU-190 100-230 VAC: 0.7-0.4 A, 1 phase, 50-60 Hz

MU-231 100-230 VAC: 1.0-0.6 A, 1 phase, 50-60 Hz

MU-270W 100-230 VAC: 0.7-0.4 A, 1 phase, 50-60 Hz

7.3 HUB (option) 100-230 VAC: 0.1 A max. 1 phase, 50/60 Hz

7.4 De-icer (option) 100-115/220-230 VAC: 2.6/1.3 A, 1 phase, 50-60 Hz

8 ENVIRONMENTAL CONDITIONS

8.1 Ambient temperature

Antenna unit -25°C to +55°C (storage: -25°C to +70°C)

Indoor units -15°C to +55°C (storage: -20°C to +70°C)

8.2 Relative humidity 93% or less at +40°C

8.3 Degree of protection

Antenna unit IP56

Processor/ monitor unit IP22

	Control unit	IP20
	HUB	IP20 (HUB-100), IP22 (HUB-3000)
8.4	Vibration	IEC 60945 Ed.4

9 UNIT COLOR

9.1	Antenna unit	N9.5
9.2	Processor unit	N2.5
9.3	Control/ monitor unit	N2.5
9.4	HUB	N3.0 (HUB-100), N2.5 (HUB-3000)
9.5	Radar console	2.5GY5/1.5 (standard), 7.5BG7/2, 2.5G7/2, N7.5

10 PERFORMANCE MONITOR

10.1 PM-32A (X-band)

Frequency range	9380 to 9440 MHz
Input power	+18 dBm to +30 dBm
Output power	-21 dBm (1 st pulse max. output), -41 dBm (1 st pulse min. output)
Step level	8 to 12 dB (1 st pulse to last pulse)

10.2 PM-52A (S-band, MAG)

Frequency range	3040 to 3080 MHz
Input power	+25 dBm to +40 dBm
Output power	-38 dBm (1 st pulse max. output), -58 dBm (1 st pulse min. output)
Step level	8 to 12 dB (1 st pulse to last pulse)

10.3 PM-52B (S-band, SSD)

Frequency range	3063.75 ±2 MHz
Input power	+5 dBm to +25 dBm
Output power	-52 dBm (1 st pulse max. output), -72 dBm (1 st pulse min. output)
Step level	8 to 12 dB (1 st pulse to last pulse)

**SPECIFICATIONS OF MARINE RADAR
FAR-2258/2358 (Non-IMO radar)**

1 ANTENNA RADIATOR

- 1.1 Type Slotted waveguide array
- 1.2 Antenna length 8 ft (XN24AF), 10 ft (XN30AF)
- 1.3 Horizontal beam width 0.95° (XN24AF), 0.75° (XN30AF)
- 1.4 Vertical beam width 20°
- 1.5 Sidelobe attenuation
 XN24AF -28 dB (within ±10° of mainlobe), -32 dB (±10° outside of mainlobe)
 XN30AF -26 dB (within ±10° of mainlobe), -33 dB (±10° outside of mainlobe)
- 1.6 Polarization Horizontal
- 1.7 Rotation 24 rpm
- 1.8 Wind load (relative) 100 kn (XN24AF), 70 kn (XN30AF)

2 TRANSCEIVER

- 2.1 TX Frequency and modulation
 9410 MHz ±30 MHz, P0N
- 2.2 Output power 50 kW
- 2.3 Range scale, Pulse Repetition Rate and Pulselength

PRR (Hz approx.)	Range scale (NM)																	
	0.125	0.25	0.5	0.75	1	1.5	2	3	4	6	8	12	16	24	32	48	96	
1900	S																	
1100				M1														
600									M2									
600											L							

1/2/4/8/16/32 NM ranges: C-type radar only

3 PROCESSOR UNIT

- 3.1 Minimum range 33 m
- 3.2 Range discrimination 25 m
- 3.3 Range accuracy 1% of the maximum range of the scale in use or 10 m, whichever is the greater
- 3.4 Bearing discrimination 1.2° (XN24AF), 1.0° (XN30AF)
- 3.5 Bearing accuracy ±1°
- 3.6 Range scale and Range ring interval (RI)

Range (NM)	0.125	0.25	0.5	0.75	1	1.5	2	3	4	6	8	12	16	24	32	48	96
RI (NM)	0.025	0.05	0.1	0.25	0.25	0.25	0.5	0.5	1	1	2	2	4	4	8	8	16
Number of rings*	5	5	5	3	4	6	4	6	4	6	4	6	4	6	4	6	6

1/2/4/8/16/32 NM ranges: C-type radar only, *: selectable from menu

- 3.7 Warm-up time 3 minutes approx.
- 3.8 Presentation mode Head-up, STAB head-up, Course-up, North-up (RM/TM), Stern-up
- 3.1 Marks Cursor, Range ring, Heading mark, North mark, Bearing mark, Target trail, VRM, EBL, Acquisition zone
- 3.2 Target tracking (TT) Auto or manual acquisition: 100 targets in 24/32/48 NM (range selected from menu for maintenance)
 Auto tracking on all acquired targets,

- 3.3 AIS
 - Tracking: 5/10 pts on all activated targets
 - Vector time: Off, 30 s, 1-60 min
 - Display capacity: 350 targets,
 - Tracking: 5/10 pts on all activated targets
 - Vector time: Off, 30 s, 1-60 min
- 3.4 Radar map 20,000 pts
- 3.5 Acquisition zone 2 zones
- 3.9 Interswitch function Selectable from menu

4 PLOTTER FUNCTIONS

- 4.1 Projection Mercator
- 4.2 Useable area 85° latitude or below
- 4.3 Effective projection area 0.025 to 120 NM (for STBY), follows the radar range scale while transmitting
- 4.4 Memory capacity
 - Own ship's track 30,000 pts (10,000 pts indicated)
 - Other ship's track TT: 100,000 pts (10,000), AIS: 10,000 pts (10,000), consort ship: 10,000 pts (1,000), GPS buoy: 10,000 pts (1,000) (): indicated pts
 - Mark/line 30,000 pts
 - Waypoint 3,500 pts
 - Route 200 routes with 100 waypoint each
- 4.5 External memory Waypoint: 100 pts, 1 route
- 4.6 Electronic chart Mapmedia
- 4.7 Own ship's tracking 7 colors

5 MONITOR UNIT

- 5.1 Screen type
 - MU-190 19-inch color LCD, 1280 x 1024 (SXGA)
 - MU-231 23.1-inch color LCD, 1600 x 1200 (UXGA)
 - MU-270W 27-inch color LCD, 1920 x 1200 (WUXGA)
- 5.2 Brightness
 - MU-190 450 cd/m² typical
 - MU-231/270W 400 cd/m² typical
- 5.3 Visible distance 1.02 m nominal (MU-190/270W) , 1.2 m (MU-231)
- 5.4 Radar effective diameter 282 mm (MU-190) ,331 mm (MU-231), 349 mm (MU-270W)

6 INTERFACE

- 6.1 Number of port (processor unit)
 - Serial 7 ports (IEC61162-1/2: 2 ports, IEC61162-1: 4 ports, AD-10: 1 port)
 - Alarm output 6 ports: contact signal, load current 250mA (Normal close/ open: 4, System fail: 1, Power fail: 1)
 - DVI output 2 ports: DVI-D, DVI-I or RGB picture data (for VDR) (RGB resolution 1280x1024 (SXGA), 60.0Hz or 1440x900 (WXGA+), 59.9Hz)
 - LAN 2 ports: Ethernet 100Base-TX

- USB 2 ports: USB flash memory and mouse/keypad
- RS-232C 1 port: brilliance control
- Sub display (for ECDIS) 2 ports: HD, BP, Trigger and Video signal
- 6.2 Data sentences (IEC61162-1/2)
 - Input ABK, ACK, ACN, ALR, BWC, BWR, CUR, DBK*¹, DBS*¹, DBT, DDC, DPT, DTM, GGA, GLL, GNS, HBT, HDT*¹, MTW, MWV, OSD, RAQ, RMB, RMC, ROT, RTE, THS, VBW, VDM, VDO, VDR, VHW, VSD, VTG, VWR*¹, VWT*¹, WPL, ZDA
 - Output ABM, ACK, AIQ, ALC, ALF, ALR, ARC, BBM, DDC, EVE, HBT, OSD, RSD, TLB, TLL, TTD, TTM, VSD

*¹: for retrofit.
- 6.3 Ethernet interface for IEC61162-450
 - Port (LAN2) 100Base-TX, IPv4, 8P8C connector
 - Data sentences Same as 6.2 sentences
 - IEC61162-450 transmission group
 - Input MISC, TGTD, SATD, NAVD, TIME, PROP
 - Output Arbitrary (default: TGTD)
 - Multicast address 239.192.0.1 to 239.192.0.16
 - Destination port 60001 to 60016
 - Re-transmittable binary image transfer
 - Multicast address 239.192.0.26 to 239.192.0.30
 - Destination port 60026 to 60030
 - Other network function excepted IEC61162-450
 - SNMP, HTTP, Syslog, Furuno Management Protocol (FMP)
- 6.4 Output port on antenna unit
 - Sub display (for radar) 1 port: HD, BP, Trigger and Video signal

7 POWER SUPPLY

- 7.1 Power supply unit 100-115/220-230 VAC: 3.1/1.5 A, 1 phase, 50-60 Hz
- 7.2 Processor unit 100-230 VAC: 2.2-1.1 A, 1 phase, 50-60 Hz
- 7.3 Monitor unit
 - MU-231 100-230 VAC: 1.0-0.6 A, 1 phase, 50-60 Hz
 - MU-190/270W 100-230 VAC: 0.7-0.4 A, 1 phase, 50-60 Hz
- 7.4 HUB (option) 100-230 VAC, 1 phase, 50/60 Hz

8 ENVIRONMENTAL CONDITIONS

- 8.1 Ambient temperature
 - Antenna unit -25°C to +55°C (storage: -25°C to +70°C)
 - Indoor unit -15°C to +55°C (storage: -20°C to +70°C)
- 8.2 Relative humidity 93% or less at +40°C
- 8.3 Degree of protection
 - Antenna unit IP56
 - Power supply unit IP22
 - Processor/ monitor unit IP22
 - Control unit IP20 (RCU-014/015/016), IP22 (RCU-031)
 - HUB IP20 (HUB-100), IP22 (HUB-3000)

8.4 Vibration IEC 60945 Ed.4

9 UNIT COLOR

9.1 Antenna unit N9.5
9.2 Power supply unit N2.5
9.3 Processor unit N2.5
9.4 Monitor/ control unit N2.5
9.5 HUB N3.0 (HUB-100), N2.5 (HUB-3000)

10 PERFORMANCE MONITOR

10.1 Frequency range 9380 to 9440 MHz
10.2 Input power +18 dBm to +30 dBm
10.3 Output power -21 dBm (1st pulse max. output), -41 dBm (1st pulse min. output)
10.4 Step level 8 to 12 dB (1st pulse to last pulse)

INDEX

A

- Acquisition zone 3-23
 - acknowledge AZ alert..... 3-25
 - activate AZ1 3-24
 - AZ shape 3-26
 - AZ stabilization 3-26
 - AZ2 polygon 3-24
 - change AZ reference..... 3-25
 - sleep a zone 3-25
- AIS
 - CPA/TCPA alarm 4-20
 - display mode selection 4-3
 - pop-up info 4-10
 - symbols and meanings 4-3
- AIS lost target
 - filtering 4-18
- AIS operation
 - activate target..... 4-5
 - auto activate function enable/disable .. 4-6, 4-7
 - controls..... 4-2
 - CPA/TCPA 4-20
 - create and save messages 4-24
 - display AIS alerts 4-27
 - display filter 4-4
 - how to set up for a voyage 4-8
 - how to sleep all targets 4-8
 - how to sleep individual targets 4-7
 - how to sleep targets 4-7
 - manually activate target 4-5
 - messages 4-24
 - own ship data 4-23
 - ROT setting 4-19
 - system messages 4-27
 - target data 4-10
 - transmit messages 4-25
 - TT/AIS association 4-21
 - view messages..... 4-26
- AIS operation
 - lost target 4-18
 - past position display 4-16
 - past position orientation 4-17
 - past position stabilization 4-17
 - symbol attributes 4-13
 - symbol brilliance..... 4-13
 - symbol color 4-13
- AIS target data
 - how to display AIS target data 4-11
 - how to remove AIS target data..... 4-12
- Alerts
 - alert icons and meanings 1-124
 - alert list..... 1-123
- Automatic Clutter Elimination (ACE) function. 1-52
- AZ..... 3-23

B

- Background colors 1-107, 1-108
- Bearing measurement..... 1-70
 - EBL key 1-71
 - methods 1-71
 - on-screen box 1-71
 - true/relative 1-72

C

- Chart
 - align..... 6-71
 - chart settings 6-73
 - icons 6-71
 - settings menu 6-73
 - show/hide 6-70
 - type selection 6-72
- Chart functions 6-70
- Chart settings 6-73
- Color palettes 1-107, 1-108
- CPA/TCPA 3-22
 - acknowledge alarm 3-23
 - set ranges 3-22, 4-20
- Cursor
 - diamond 1-97
 - net 1-97
- Customized echo
 - editing..... 1-59
 - restoring to factory default settings 1-60
 - restoring to saved settings 1-60

D

- Diamond cursor..... 1-97
- Display mode 1-126
- DRIFT..... 3-21

E

- EBL collision assessment
 - assess risk..... 1-73
 - set reference point 1-74

F

- False echoes
 - multiple echoes 2-3
 - shadow sectors 2-5
 - sidelobe echoes 2-4
 - virtual images 2-4

H

- Heading line
 - how to hide the heading line 1-101

I

- Interswitch
 - antenna information 1-113

INDEX

L

- Lost target alert
 - enable/disable alert 3-8, 4-19

M

- Maintenance
 - major parts life expectancy7-4
 - periodic schedule7-2

MARKS

- C-type marks6-20
- deleting origin marks (C-types)6-38
- deleting up marks for C-types6-26
- editing up marks for C-types6-28
- entering origin marks (C-types)6-37
- entering up marks for C-types6-22
- filtering marks (C-types)6-31
- origin marks (C-types)6-36
- setting up marks for C-types6-20
- setting up origin marks (C-types)6-36
- viewing mark information (C-types)6-29

Marks

- barge mark1-104
- delete marks5-5
- hide heading line1-101
- how to inscribe a mark5-3
- INS mark5-10
- mark inscription position5-2
- mark type5-1
- origin mark stabilization5-8
- own ship symbol settings1-104
- show/hide stern mark1-102
- Menu operations1-17
 - main menu1-17
 - menu layers1-18

N

- Nav data
 - display settings1-109
 - enable/disable display1-110
- Net cursor1-97
- Noise rejector1-54
- NR1-54

O

- Observation
 - bearing accuracy2-3
 - false echoes2-3
 - range measurement2-3
 - resolution2-2
- Off-center1-78
- Orientation modes
 - description1-64
 - selection1-64
- Origin mark
 - inscribing5-7

P

- Parallel index lines1-93
 - bearing and interval1-94
 - bearing reference1-94

- displayed lines1-93
- length adjustment1-96
- orientation1-95
- reset1-95

Past position

- POSN plotting intervals3-20, 4-16
- set points to display3-20, 4-17
- show/hide past POSN3-20, 4-16

Past position display3-20

PAST POSN3-20

Performance monitor

- activate/deactivate1-116
- check radar performance1-118

PI1-93

PI lines1-93

R

RACON2-7

Radar map5-3

- disable map alignment5-6, 6-72
- enable map alignment5-6

Radar Target Enhancer2-7

Range and bearing measurement1-75

- how to measure1-76

Range measurement1-67

- on-screen box1-68
- TTG to VRM1-70
- VRM key1-68
- VRM units1-69

Range rings

- hide/show rings1-67

RTE2-7

S

SART2-5

- bandwidth2-6
- description2-5
- radar sidelobes2-7
- range errors2-6
- show/hide SART marks2-6

SC card

- delete data1-131
- load data1-131
- read data1-131
- save data1-131

Search and rescue transponder2-5

SET3-21

SET DRIFT3-21

Static trial maneuver3-28

Symbols

- general radar symbolsAP-32
- IMO map radar symbolsAP-33
- radar(AIS symbols)AP-34
- radar(TT symbols)AP-34

T

Target alarm1-91

- alarm settings1-92
- deactivate1-92
- mute1-92

- on/off 1-91
- setting 1-91
- Target tracking
 - controls 3-2
 - display/remove target data 3-14
 - echo referenced speed 3-5
 - hide target list 3-15
 - lost target 3-8
 - lost target filter 3-8
 - mode selection 3-3
 - on-screen box overview 3-2
 - own ship speed 3-5
 - selection criteria 3-33
 - show target list 3-15
 - simulation mode 3-32
 - sort target list 3-15
 - symbol brilliance 3-9
 - symbol color 3-9
 - symbols and attributes 3-9
 - system messages 3-31
- Target trails 1-79
 - clutter prevention 1-84
 - hide trails 1-83
 - narrow trails 1-83
 - trail erase/restart 1-84
 - trail gradation 1-82
 - trail level 1-82
 - trail stabilization 1-83
 - trail time 1-81
 - true/relative 1-79
- Tracks
 - auto-display tracks for C-types 6-4
 - changing display size for C-types 6-2
 - consort/GPS buoy info for C-types 6-17
 - C-types 6-1
 - delete other tracks for C-types 6-19
 - editing tracks for C-types 6-16
 - hiding other tracks for C-types 6-2
 - OS vector for C-types 6-2
 - show/hide other vectors for C-types 6-3
 - show/hide tracks for C-types 6-3
 - Symbols for C-types 6-1
 - track color for C-types 6-6
 - track delete for C-types 6-14
 - track lines for C-types 6-12
 - track recording for C-types 6-5
 - track recording method/intervals for C-types 6-13
- Trial maneuver
 - static trial 3-28
- Troubleshooting
 - advanced troubleshooting 7-6
 - basic troubleshooting 7-5
 - diagnostics 7-8
- TT 1-79
 - static trial maneuver 3-28
- V**
- Vector modes 3-17
 - description 3-17
- vector length 3-19
- vector time 3-19
- Video plotter
 - create waypoints 5-13
 - delete own ship's track 5-12
 - delete waypoints 5-15
 - display waypoint list 5-16
 - display waypoint name/number 5-16
 - enter waypoints 5-13
 - orientation modes 5-1
 - own ship's track 5-11
 - own ship's track plot interval 5-12
 - radar map 5-3
 - waypoints 5-13
- W**
- Waypoints
 - changing display name (C-types) 6-48
 - changing display size (C-types) 6-48
 - creating waypoints (C-types) 6-39
 - deleting waypoints (C-types) 6-45
 - editing waypoints (C-types) 6-45
 - external (C-types) 6-49
 - searching the waypoints list (C-types) 6-46
 - setting the voyage speed (C-types) 6-47
 - viewing waypoint information (C-types) 6-47
- Waypoints (C-types) 6-39
- Wiper 1-54

Declaration of Conformity

**[FAR-2218/FAR-2218-BB/FAR-2228/FAR-2228-BB/FAR-2238S
FAR-2238S-BB/FAR-2238S-NXT/FAR-2238S-NXT-BB/FAR-2258/FAR-2258-BB/
FAR-2358/FAR-2318/FAR-2328/FAR-2338S/FAR-2338S-NXT]**

- Bulgarian (BG)** С настоящото Furuno Electric Co., Ltd. декларира, че гореспоменат тип радиосъоръжение е в съответствие с Директива 2014/53/EC, SI 2017/1206. Цялостният текст на ЕС/UK декларацията за съответствие може да се намери на следния интернет адрес:
- Spanish (ES)** Por la presente, Furuno Electric Co., Ltd. declara que el tipo de equipo radioeléctrico arriba mencionado es conforme con la Directiva 2014/53/UE, SI 2017/1206. El texto completo de la declaración de conformidad de la EU/UK está disponible en la siguiente dirección Internet:
- Czech (CS)** Tímto Furuno Electric Co., Ltd. prohlašuje, že výše zmíněné typ rádiového zařízení je v souladu se směrnicí 2014/53/EU, SI 2017/1206. Úplné znění EU/SK prohlášení o shodě je k dispozici na této internetové adrese:
- Danish (DA)** Hermed erklærer Furuno Electric Co., Ltd., at ovennævnte radioudstyr er i overensstemmelse med direktiv 2014/53/EU, SI 2017/1206. EU/UK-overensstemmelseserklæringens fulde tekst kan findes på følgende internetadresse:
- German (DE)** Hiermit erkläre die Furuno Electric Co., Ltd., dass der oben genannte Funkanlagentyp der Richtlinie 2014/53/EU, SI 2017/1206 entspricht. Der vollständige Text der EU/UK-Konformitätserklärung ist unter der folgenden Internetadresse verfügbar:
- Estonian (ET)** Käesolevaga deklareerib Furuno Electric Co., Ltd., et ülalmainitud raadioseadme tüüp vastab direktiivi 2014/53/EL, SI 2017/1206 nõuetele. EL/GB vastavusdeklaratsiooni täielik tekst on kättesaadav järgmisel internetiaadressil:
- Greek (EL)** Με την παρούσα η Furuno Electric Co., Ltd., δηλώνει ότι ο προαναφερθέντας ραδιοεξοπλισμός πληροί την οδηγία 2014/53/EE, SI 2017/1206. Το πλήρες κείμενο της δήλωσης συμμόρφωσης EE/UK διατίθεται στην ακόλουθη ιστοσελίδα στο διαδίκτυο:
- English (EN)** Hereby, Furuno Electric Co., Ltd. declares that the above-mentioned radio equipment type is in compliance with Directive 2014/53/EU, SI 2017/1206. The full text of the EU/UK declaration of conformity is available at the following internet address:
- French (FR)** Le soussigné, Furuno Electric Co., Ltd., déclare que l'équipement radioélectrique du type mentionné ci-dessus est conforme à la directive 2014/53/UE, SI 2017/1206. Le texte complet de la déclaration UE/RU de conformité est disponible à l'adresse internet suivante:
- Croatian (HR)** Furuno Electric Co., Ltd. ovime izjavljuje da je gore rečeno radijska oprema tipa u skladu s Direktivom 2014/53/EU, SI 2017/1206. Cjeloviti tekst EU/UK izjave o sukladnosti dostupan je na sljedećoj internetskoj adresi:
- Italian (IT)** Il fabbricante, Furuno Electric Co., Ltd., dichiara che il tipo di apparecchiatura radio menzionato sopra è conforme alla direttiva 2014/53/UE, SI 2017/1206. Il testo completo della dichiarazione di conformità UE/RU è disponibile al seguente indirizzo Internet:
- Latvian (LV)** Ar šo Furuno Electric Co., Ltd. deklarē, ka augstāk minēts radioiekārta atbilst Direktīvai 2014/53/ES, SI 2017/1206. Pilns ES/AK atbilstības deklarācijas teksts ir pieejams šādā interneta vietnē:

- Lithuanian (LT) Aš, Furuno Electric Co., Ltd., patvirtinu, kad pirmiau minėta radijo įrenginių tipas atitinka Direktyvą 2014/53/ES, SI 2017/1206.
Visas ES/JK atitikties deklaracijos tekstas prieinamas šiuo interneto adresu:
- Hungarian (HU) Furuno Electric Co., Ltd. igazolja, hogy fent említett típusú rádióberendezés megfelel a 2014/53/EU, SI 2017/1206 irányelvnek.
Az EU/EK-megfelelőségi nyilatkozat teljes szövege elérhető a következő internetes címen:
- Maltese (MT) B'dan, Furuno Electric Co., Ltd., niddikjara li msemmija hawn fuq-tip ta' tagħmir tar-radju huwa konformi mad-Direttiva 2014/53/UE, SI 2017/1206.
It-test kollu tad-dikjarazzjoni ta' konformità tal-UE/RU huwa disponibbli f'dan l-indirizz tal-Internet li ġej:
- Dutch (NL) Hierbij verklaar ik, Furuno Electric Co., Ltd., dat het hierboven genoemde type radioapparaat conform is met Richtlijn 2014/53/EU, SI 2017/1206.
De volledige tekst van de EU/VK-conformiteitsverklaring kan worden geraadpleegd op het volgende internetadres:
- Polish (PL) Furuno Electric Co., Ltd. niniejszym oświadcza, że wyżej wymieniony typ urządzenia radiowego jest zgodny z dyrektywą 2014/53/UE, SI 2017/1206
Pełny tekst deklaracji zgodności UE/UK jest dostępny pod następującym adresem internetowym:
- Portuguese (PT) O(a) abaixo assinado(a) Furuno Electric Co., Ltd. declara que o mencionado acima tipo de equipamento de rádio está em conformidade com a Diretiva 2014/53/UE, SI 2017/1206.
O texto integral da declaração de conformidade da EU/UK está disponível no seguinte endereço de Internet:
- Romanian (RO) Prin prezenta, Furuno Electric Co., Ltd. declară că echipamentul radio menționat mai sus este în conformitate cu Directiva 2014/53/UE, SI 2017/1206.
Textul integral al declarației de conformitate UE/RU este disponibil la următoarea adresă internet:
- Slovak (SK) Furuno Electric Co., Ltd. týmto vyhlasuje, že vyššie spomínané rádiové zariadenie typu je v súlade so smernicou 2014/53/EÚ, SI 2017/1206
Úplné EÚ/SK vyhlásenie o zhode je k dispozícii na tejto internetovej adrese:
- Slovenian (SL) Furuno Electric Co., Ltd. potrjuje, da je zgoraj omenjeno tip radijske opreme skladen z Direktivo 2014/53/EU, SI 2017/1206.
Celotno besedilo izjave EU/ZK o skladnosti je na voljo na naslednjem spletnem naslovu:
- Finnish (FI) Furuno Electric Co., Ltd. vakuuttaa, että yllä mainittu radiolaitetyyppi on direktiivin 2014/53/EU, SI 2017/1206 mukainen.
EU/UK-vaatimustenmukaisuusvakuutuksen täysimittainen teksti on saatavilla seuraavassa internetosoitteessa:
- Swedish (SV) Härmed försäkrar Furuno Electric Co., Ltd. att ovan nämnda typ av radioutrustning överensstämmer med direktiv 2014/53/EU, SI 2017/1206.
Den fullständiga texten till EU/Storbritannien-försäkran om överensstämmelse finns på följande webbadress:

Online Resource

http://www.furuno.com/en/support/red_doc

Notice for radiated immunity

The test for the radiated immunity is performed up to 2.7 GHz only without the special condition of spot frequency being applied. There is a chance that this equipment may interfere with allocated services in the frequency range of 2.7 GHz to 6 GHz, particularly in harbors, rivers, lake banks, etc.