

FURUNO

OPERATOR'S MANUAL

COLOR LCD SOUNDER

Model **FCV-295**

FURUNO ELECTRIC CO., LTD.

9-52 Ashihara-cho,
Nishinomiya, 662-8580, JAPAN

• FURUNO Authorized Distributor/Dealer

All rights reserved. Printed in Japan

Pub. No. OME-23760-F1

(ETMI) FCV-295

A : MAY 2008
F1 : OCT. 19, 2022



0 0 0 1 6 8 5 0 8 1 5

IMPORTANT NOTICES

General

- This manual has been authored with simplified grammar, to meet the needs of international users.
- The operator of this equipment must read and follow the instructions in this manual. Wrong operation or maintenance can void the warranty or cause injury.
- Do not copy any part of this manual without written permission from FURUNO.
- If this manual is lost or worn, contact your dealer about replacement.
- The contents of this manual and the equipment specifications can change without notice.
- The example screens (or illustrations) shown in this manual can be different from the screens you see on your display. The screens you see depend on your system configuration and equipment settings.
- Save this manual for future reference.
- Any modification of the equipment (including software) by persons not authorized by FURUNO will void the warranty.
- The following concern acts as our importer in Europe, as defined in DECISION No 768/2008/EC.
 - Name: FURUNO EUROPE B.V.
 - Address: Siriusstraat 86, 5015 BT, Tilburg, The Netherlands
- The following concern acts as our importer in UK, as defined in SI 2016/1025 as amended SI 2019/470.
 - Name: FURUNO (UK) LTD.
 - Address: West Building Penner Road Havant Hampshire PO9 1QY, U.K.
- All brand, product names, trademarks, registered trademarks, and service marks belong to their respective holders.

How to discard this product

Discard this product according to local regulations for the disposal of industrial waste. For disposal in the USA, see the homepage of the Electronics Industries Alliance (<http://www.eiae.org/>) for the correct method of disposal.

How to discard a used battery

Some FURUNO products have a battery(ies). To see if your product has a battery, see the chapter on Maintenance. If a battery is used, tape the + and - terminals of the battery before disposal to prevent fire, heat generation caused by short circuit.

In the European Union

The crossed-out trash can symbol indicates that all types of batteries must not be discarded in standard trash, or at a trash site. Take the used batteries to a battery collection site according to your national legislation and the Batteries Directive 2006/66/EU.

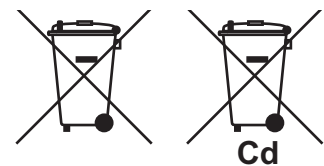

In the USA

The Mobius loop symbol (three chasing arrows) indicates that Ni-Cd and lead-acid rechargeable batteries must be recycled. Take the used batteries to a battery collection site according to local laws.

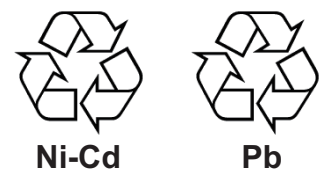

In the other countries

There are no international standards for the battery recycle symbol. The number of symbols can increase when the other countries make their own recycle symbols in the future.



SAFETY INSTRUCTIONS

The operator and installer must read the applicable safety instructions before attempting to install or operate the equipment.



WARNING

Indicates a potentially hazardous situation which, if not avoided, could result in death or serious injury.



CAUTION

Indicates a potentially hazardous situation which, if not avoided, can result in minor or moderate injury.



Warning, Caution



Prohibitive Action



Mandatory Action



WARNING



ELECTRICAL SHOCK HAZARD Do not open the equipment.

Hazardous voltage exists inside the equipment. Refer repair to authorized service personnel.



Immediately turn off the power at the switchboard if something is dropped into the equipment.

Continued use of the equipment can cause fire or electrical shock.



Immediately turn off the power at the switchboard if the equipment is emitting smoke or fire.

Continued use of the equipment can cause fire or electrical shock. Contact a FURUNO agent for service.



Do not disassemble or modify the equipment.

Fire, electrical shock or injury can result.



WARNING



Do not put containers with liquids on the top of the equipment.

Fire, electrical shock or injury can result.



If you feel that the equipment is acting abnormally, immediately turn off the power at the switchboard.

If the equipment is excessively warm or making strange noises, immediately turn off the equipment at the switchboard.



Keep the equipment away from rain and water splash.

Fire, electrical shock or injury can result if water leaks into the equipment.







Use the proper fuse.



Use of an incorrect fuse can damage the equipment and can cause fire.



Do not operate the equipment with wet hands.

Electrical shock can result.

 CAUTION
<p> Do not transmit with the transducer out of water.</p> <p>The transducer will be damaged.</p>
<p> Do not use depth information for navigation while the picture advance speed is set to "stop".</p> <p>The depth indication is not refreshed while the picture is stopped. Use of depth data for navigation in this case could lead to grounding or other dangerous situation.</p>
<p> Do not handle the LCD's panel roughly; it is made of glass.</p> <p>Injury can result if the glass breaks.</p>
<p> Do not use high-pressure cleaners to clean this equipment.</p> <p>This equipment has the waterproof rating outlined in the specifications, at the back of this manual. However, the use of high-pressure cleaning equipment can cause water ingress, resulting in damage to, or failure of, the equipment.</p>

 CAUTION
<p> Properly adjust the gain.</p> <p>Too little gain may present no picture. Too much gain shows excessive noise on the picture. Using the depth data for navigation when the gain is incorrectly set can lead to a dangerous situation.</p>
<p> The data presented by this equipment is intended as a source of navigation information.</p> <p>The prudent navigator never relies exclusively on any one source of navigation information, for safety of vessel and crew.</p>

Warning Labels

Warning labels are attached to the equipment. Do not remove the labels. If a label is missing or illegible, contact a FURUNO agent or dealer about replacement.

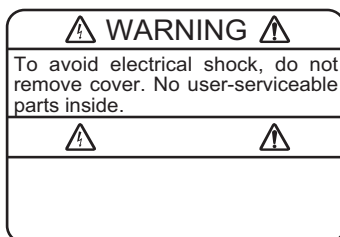

Name: Warning Label (1)
 Type: 86-003-1011-3
 Code No.: 100-236-233-10

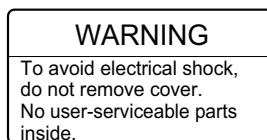

Name: Warning Label (2)
 Type: 803-129-1001-3
 Code No.: 100-236-743-10

TABLE OF CONTENTS

FOREWORD	v
SYSTEM CONFIGURATION	vi
1. OPERATION	1
1.1 Control Description.....	1
1.2 Power On/Off	2
1.3 How to Adjust Display Brilliance and Panel Dimmer	2
1.4 Selecting a Display.....	2
1.4.1 Single frequency display.....	2
1.4.2 Dual frequency display	3
1.4.3 Zoom display	3
1.4.4 User 1 and 2 displays	5
1.5 Selecting a Range.....	5
1.5.1 Range adjustment.....	5
1.5.2 Manual range adjustment	5
1.6 Shifting the Range.....	6
1.7 Adjusting the Gain.....	7
1.7.1 Selecting gain adjustment....	7
1.7.2 Manual gain adjustment.....	7
1.8 Measuring Depth.....	8
1.9 Menu Operating Procedure.....	8
1.10 Picture Advance Speed.....	9
1.11 Rejecting Interference	9
1.12 Erasing Weak Echoes	10
1.13 Rejecting Clutter.....	10
1.14 Adjusting TVG	11
1.15 A-scope Display	12
1.16 Alarms	13
1.17 FUNCTION Control	15
1.17.1 Using the FUNCTION control	15
1.17.2 Programming the FUNCTION control	15
1.18 Waypoints	16
1.18.1 Entering a waypoint	16
1.18.2 Editing waypoints.....	17
1.18.3 Erasing waypoints.....	17
1.18.4 Setting destination waypoint.....	18
1.19 Menu Description	18
1.19.1 Sounder menu	18
1.19.2 Tx/Rx menu	22
1.19.3 Display menu	22
1.19.4 Data menu	23
2. SYSTEM MENU	25
2.1 How to Open the System Menu	25
2.2 User Menu.....	25
2.2.1 User menu description.....	25
2.2.2 Selecting data for nav data displays.....	28
2.3 Range Menu	29
2.4 Key Menu.....	29
2.5 Language Menu	30
2.6 Units Menu.....	30
2.7 Calib Menu.....	30
3. MAINTENANCE & TROUBLESHOOTING	32
3.1 Maintenance	32
3.2 Care of Display Unit.....	32
3.3 Transducer Maintenance	32
3.4 Fuse Replacement.....	33
3.5 Battery Voltage Alert.....	33
3.6 Troubleshooting	33
3.7 Self Test.....	34
3.8 LCD Test.....	35
3.9 Restoring Default Settings	35
APPX. 1 MENU TREE	AP-1
APPX. 2 SCREEN LAYOUT	AP-4
APPX. 3 SCREEN DIVISION	AP-7
SPECIFICATIONS	SP-1
INDEX	IN-1

FOREWORD

A Word to FCV-295 Owners

Congratulations on your choice of the FURUNO FCV-295 Color LCD Sounder. We are confident you will see why the FURUNO name has become synonymous with quality and reliability.

Since 1948, FURUNO Electric Company has enjoyed an enviable reputation for innovative and dependable marine electronics equipment. This dedication to excellence is furthered by our extensive global network of agents and dealers.

This equipment is designed and constructed to meet the rigorous demands of the marine environment. However, no machine can perform its intended function unless installed, operated and maintained properly. Please carefully read and follow the recommended procedures for operation and maintenance.

We would appreciate hearing from you, the end-user, about whether we are achieving our purposes.

Thank you for considering and purchasing FURUNO equipment.

Features

The FURUNO FCV-295 is a dual frequency Color LCD Sounder. Comprised of a display unit and a transducer, the FCV-295 displays underwater conditions on a 10.4-inch color LCD in various colors according to echo strength.

The main features of the FCV-295 are

- FURUNO Free Synthesizer (FFS) transceiver design allows use of user-selectable operating frequencies.
- 64-color (including background) presentation provides detailed information on fish density and bottom composition.
- Automatic operation selects correct range and gain to show fish echoes and bottom in both shallow and deep waters.
- In addition to the conventional gain setting, Gain may be applied to the whole display.
- Alarms: Bottom, Fish (bottom lock and normal), Speed*, Water Temperature*, and Arrival*.
- Edge function of white marker traces the bottom contour with a thin white line.
- Zero line may be removed to look for fish near the surface.
- User-programmable nav data displays provide analog and digital nav data.
- Waypoints (up to 20) for marking important locations.
- Destination waypoint feature provides range, bearing and time-to-go to destination waypoint.

* Requires appropriate sensors.

The TFT LCD is constructed using the latest LCD techniques, and displays 99.99% of its pixels. The remaining 0.01% of the pixels may drop out or blink, however this is not an indication of malfunction.

CE/UKCA declaration

With regards to CE/UKCA declarations, please refer to our website (www.furuno.com) for further information about RoHS conformity declarations.

Disclosure of Information about China RoHS

With regards to China RoHS information for our products, please refer to our website (www.furuno.com).

SYSTEM CONFIGURATION

Basic configuration is shown below with solid line.

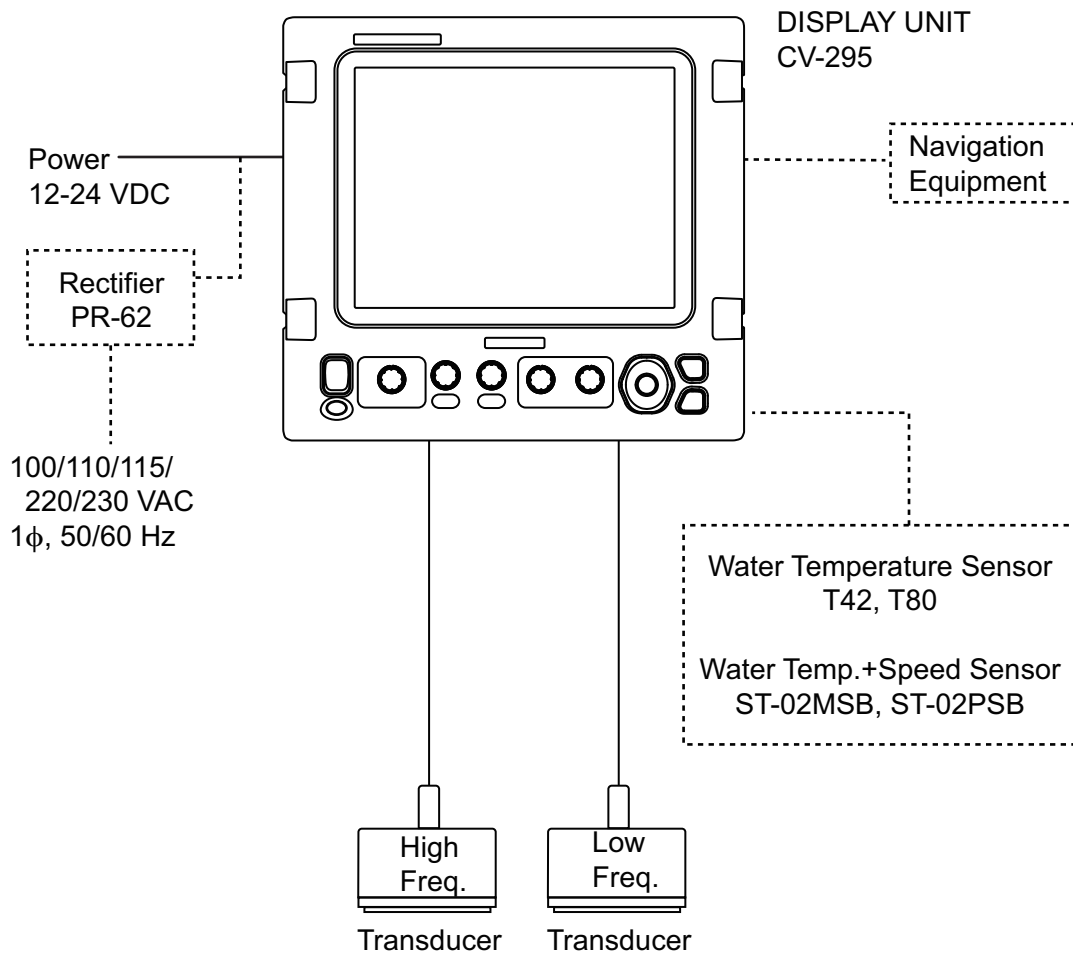

Operator's Guide

Operator's Guide gives you the basic information on the operation of this model.

Please visit our website from the following two dimensional code. Manuals for other models are also available on our website.



Operator's Guide is available in the following 16 languages.

- English
- French
- Spanish
- German
- Italian
- Portuguese
- Danish
- Swedish
- Norwegian
- Finnish
- Greek
- Simplified Chinese
- Thai
- Korean
- Russian
- Japanese

Each language has two pages.

1. OPERATION

1.1 Control Description

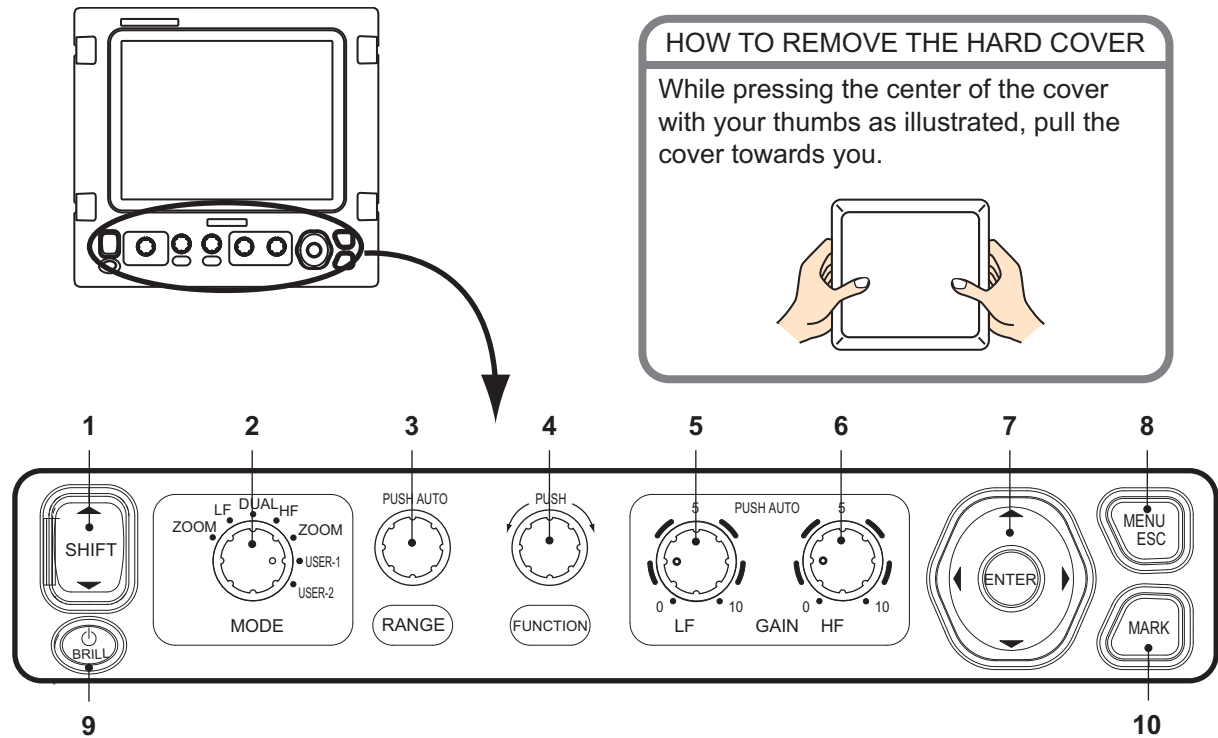

No.	Control	Function
1	▲ SHIFT ▼	Shift the display range. (Inoperative when auto range or auto shift is active.)
2	MODE	Select display mode.
3	RANGE	Push: Show the auto range setting window. Rotate: Manually select range. (Inoperative when auto range is active.)
4	FUNCTION	Long push: Display function key setting window. Momentary push: Display window programmed. Rotate: Select item in setting window.
5, 6	GAIN HF, GAIN LF	Push: Display high or low frequency auto gain setting window. Rotate: Manually adjust gain. (Inoperative when auto gain is active.)
7	ENTER ▲▼◀▶ (Cursor pad)	<ul style="list-style-type: none"> Select items on menus. Change settings Move VRM. (Inoperative when Nav Data is displayed.) Push ENTER key to confirm setting.
8	MENU/ESC	<ul style="list-style-type: none"> Open/close menu. Escape from current operation.
9	⏻/BRILL	<ul style="list-style-type: none"> Turn power on (momentary push) and off (long push). Open display brilliance setting window, with power turned on.
10	MARK	Record position of an important echo as a waypoint. (Output latitude and longitude position to a chart plotter if connected.)

1. OPERATION

1.2 Power On/Off

Press the /BRILL key to turn on the power. The unit beeps, the startup screen appears and then the last-used display is shown.

To turn off the power, press the /BRILL key more than three seconds. The time remaining until power off is counted down on the screen.



Note: After turning the power off, wait approximately 10 seconds before turning the power on again.



1.3 How to Adjust Display Brilliance and Panel Dimmer

1. With the equipment powered, press the /BRILL key momentarily to show the brilliance adjustment window for the display and the panel.



2. Press the /BRILL key to adjust brilliance. Continuous pressing changes the brilliance cyclically. (0→1→...→9→8→...→0→1→...). "0" is the lowest and "9" is the highest. You can also use  or  for the adjustment.
3. Press the **ENTER** or **MENU/ESC** key to save the setting and close the window. (The window is automatically closed if the brilliance is not adjusted within approx. six seconds.)

Note: When the power is reapplied after turning off the equipment with minimum brilliance,

minimum brilliance will be set after the equipment goes through its initial start up. (The start up screen appears with the maximum brilliance.) Adjust the brilliance as necessary.

1.4 Selecting a Display

The FCV-295 has seven display modes: low frequency display, high frequency display, dual frequency display, low frequency+zoom, high frequency+zoom, user 1 display, and user 2 display. Select one with the **MODE** control as follows:

1. Rotate the **MODE** control to open the mode selection window.

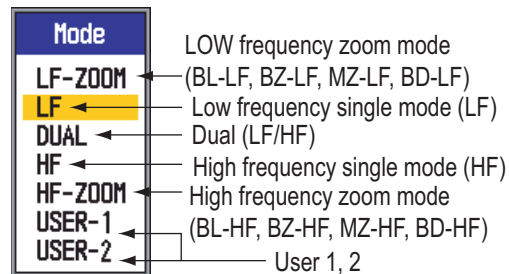

() : Mode indication at the top of the screen
BL: Bottom Lock LF: Low Frequency
BZ: Bottom Zoom HF: High Frequency
MZ: Marker Zoom BD: Bottom Discrimination

2. Rotate the **MODE** control to select a display.

1.4.1 Single frequency display

Low frequency

The lower the frequency of the ultrasonic signal, the wider the detection area. Therefore, the low frequency is useful for general detection and judging bottom condition.

High frequency

The higher the frequency of the ultrasonic signal, the better the resolution. For this reason the high frequency is ideal for detailed observation of fish schools.

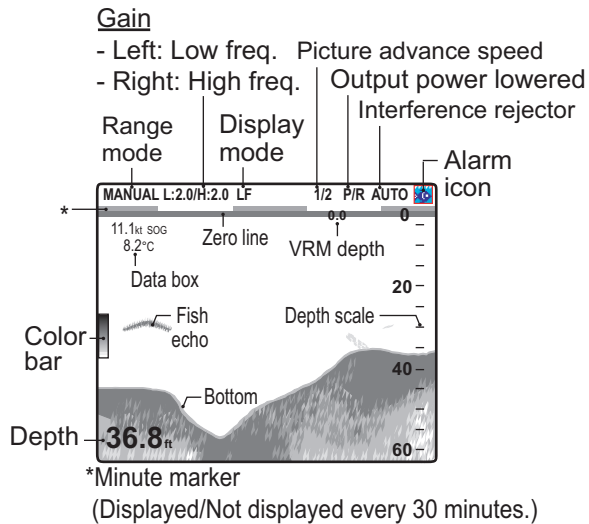
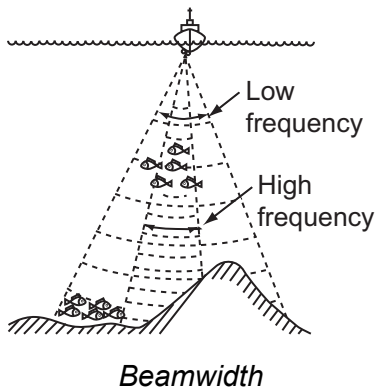

1.4.2 Dual frequency display

The low frequency picture appears on the left; the high frequency picture on the right. This display is useful for comparing underwater conditions with two different frequencies.

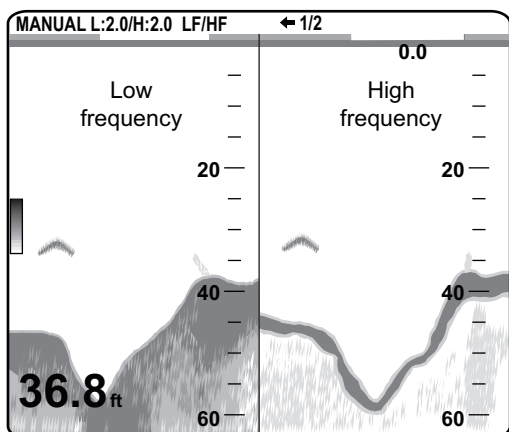

Freq. (kHz)	Beamwidth	Resolution	Detection range	Bottom tail
50	Wide	Low	Deep	Long
200	Narrow	High	Shallow	Short

Note: The default split is the vertical split. Horizontal split is also available. Zoom displays may also be shown on split screens.

1.4.3 Zoom display

Zoom mode expands chosen area of the single frequency picture. Five modes are available: bottom lock, bottom zoom, marker zoom and two bottom discrimination modes. The default mode is bottom lock. You can preset the zoom mode to use on the Sounder menu.

Bottom lock display

The bottom lock display provides a normal picture on the right half of the screen and a 16-600 feet (default: 16 feet) wide layer in contact with the bottom is expanded onto the left half of the screen. This mode is useful for detecting bottom fish.

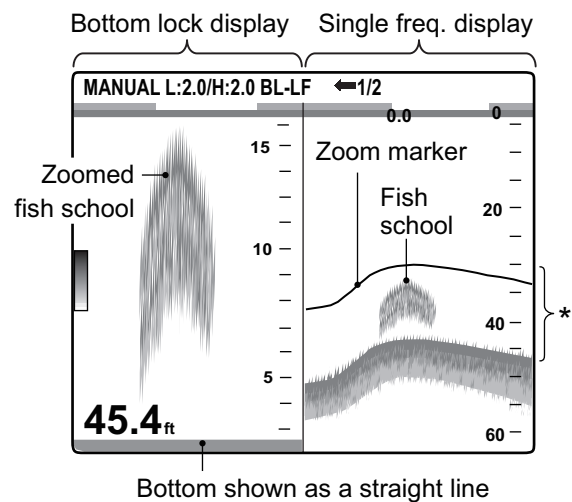

*This area zoomed and displayed on left half of screen.

Note 1: The range of the zoom display can be adjusted on the Range menu.

Note 2: The zoom marker can be turned on or off on the Display menu.

1. OPERATION

Bottom zoom display

This mode expands bottom and bottom fish on the left-half window, and is useful for determining bottom contour. When the bottom depth increases, the display automatically shifts to keep the bottom echo at the lower part of the screen.

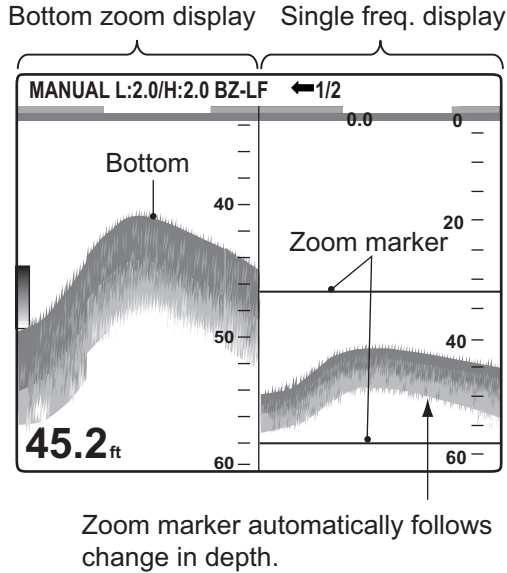

Marker zoom display

This mode expands chosen area of the normal picture to full vertical size of the screen on the left-half window. You may specify the portion to expand by operating the VRM (Variable Range Marker), which you can shift with ▲ or ▼. The area between the VRM and zoom marker is expanded. This mode is useful for determining the size of fish in the middle water.

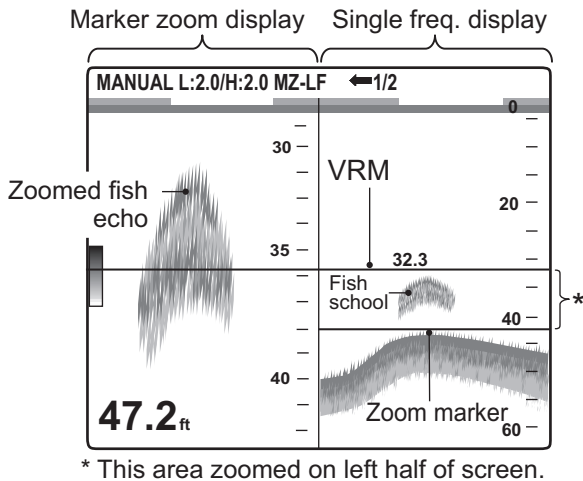

Bottom discrimination 1/2 display

The bottom discrimination 1/2 screen shows the single picture on the right half of the screen and the bottom discrimination display occupies the left half of the screen. The bottom discrimination display shows the bottom as a straight line, which is useful for determining bottom hardness.

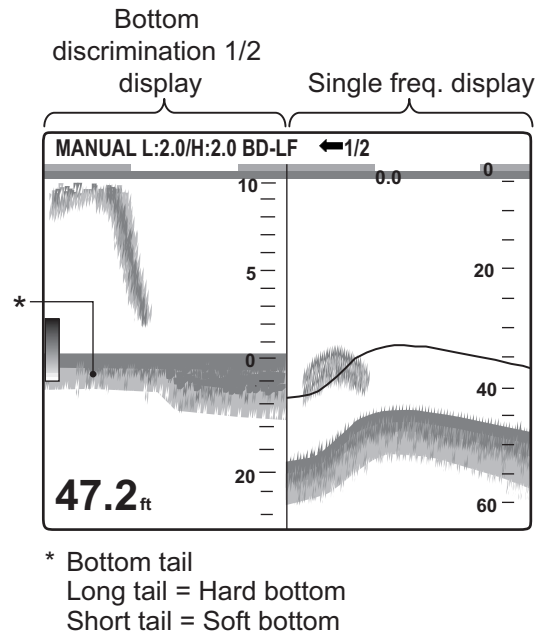

Bottom discrimination 1/3 display

This display is similar to the bottom discrimination 1/2 display except the bottom discriminator display occupies the bottom one-third of the left half of the screen as below.

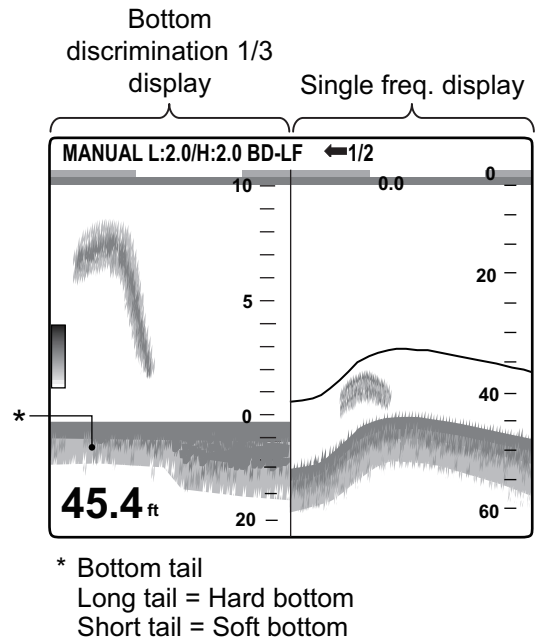

1.4.4 User 1 and 2 displays

The user displays let you customize displays as desired. Two displays are provided and the default settings for each are

User 1 display: This screen is split vertically three ways and is comprised of LF, HF and MIX displays.

User 2 display: This display is split in fourths and is comprised of LF, HF, LF bottom zoom and HF bottom zoom displays.

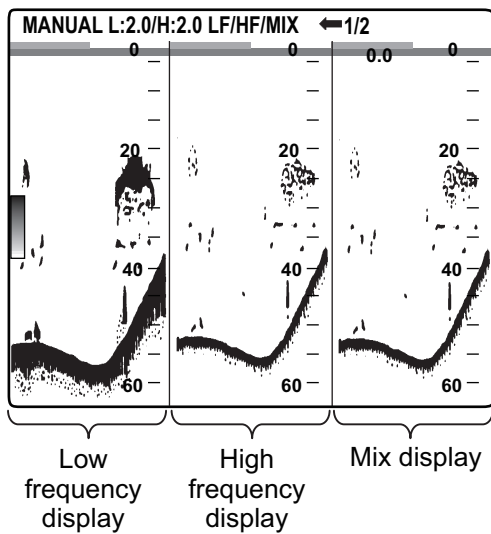

Default user 1 display

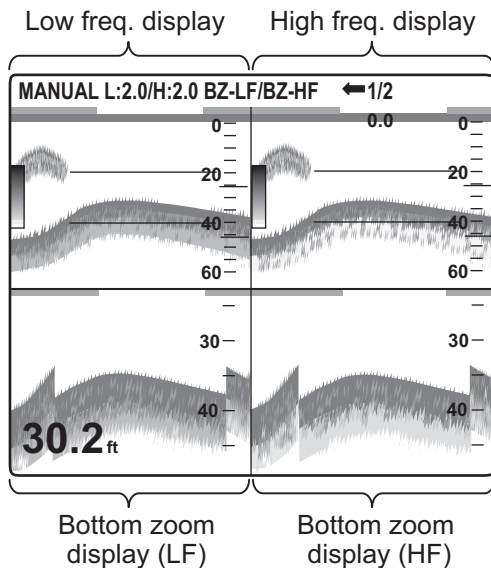

Default user 2 display

1.5 Selecting a Range

1.5.1 Range adjustment

Range can be adjusted manually or automatically. Automatic adjustment is useful when you are preoccupied with other tasks and do not have the time to adjust the display.

1. Push the **RANGE** control to open the auto range setting window.

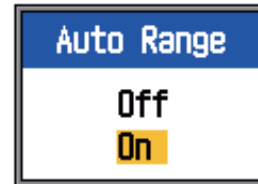

2. Use ▲ or ▼ to select Off or On as appropriate.

On: The range is automatically changed to keep the bottom echo on the lower half of the screen. Range shift and gain are in-operative when Auto Range is active.

"AUTO_R" is shown at the top left corner on the screen.

Off: The range may be chosen from eight basic ranges. MANUAL is shown at the top left corner on the screen.

3. Press the [ENTER] key to save the setting.

1.5.2 Manual range adjustment

1. Rotate the **RANGE** control to show the range selection window.

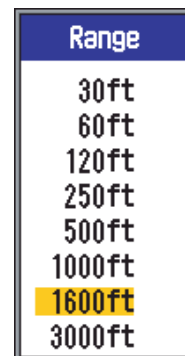

Note: If you are using the dual frequency display, and are set up for independent range adjustment, long push the **RANGE** control to switch between low and high

1. OPERATION

frequencies alternately. For details see "Split Range" in section 2.3 "Range Menu".

2. Rotate the **RANGE** control to select a range. The default ranges are as shown in the table.

Basic Range No, Range				
Unit	1	2	3	4
m	10	20	40	80
ft	30	60	120	250
fa	5	10	20	40
HR*	6	12	25	50
pb	6	12	25	50

Unit	5	6	7	8
m	150	300	500	1000
ft	500	1000	1600	3000
fa	80	160	250	600
HR*	100	200	300	600
pb	100	200	300	600

* HR is Hiro, Japanese unit of depth measurement.

Note 1: Basic ranges may be preset as desired, on the Range menu.

Note 2: The range mode indication (AUTO_R or MANUAL), which appears at the top-left corner, may be turned on or off with Header Info in the Display menu.

Note 3: In the dual frequency display, the range for the low and high frequencies can be adjusted mutually or independently. Turn on Split Range in the Range menu to enable independent adjustment.

1.6 Shifting the Range

The basic range and range shifting functions used together give you the means to select the depth you can see on the screen. The basic range can be thought of as providing a "window" into the water column and range shifting as moving the "window" to the desired depth.

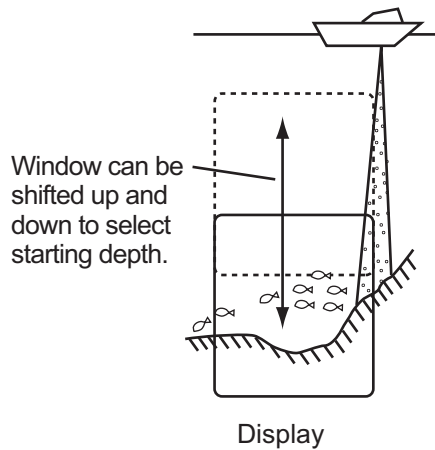

Note: This function is inoperative when the Auto Range or Auto Shift is active.

1. Press ▲ or ▼ on the **SHIFT** key to show the Shift setting window.

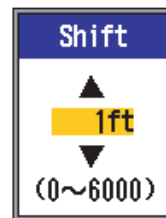

2. Use ▲ or ▼ on the **SHIFT** key to select the amount of shift desired.
3. Press the **MENU/ESC** key to close the window, or wait six seconds to automatically close it.

Note 1: The bottom echo may be lost if the amount of shift is greater than actual depth.

Note 2: "Auto Shift," which can be turned on from the Sounder menu, automatically shifts the range to keep the bottom echo on the screen.

Note 3: You can set the shift value for each range independently, by turning on Free Shift in the Sounder menu.

1.7 Adjusting the Gain

The gain may be adjusted automatically (Fishing or Cruising) or manually. In automatic operation, the gain is automatically adjusted to display the bottom echo in reddish brown. If you need to lower or higher the gain in automatic operation, use the gain offset feature. For manual adjustment, see sec. 1.7.2.

The Gain Area setting on the Sounder menu determines how gain is adjusted. For setting details, see Gain Area in sec. 1.19.1.

The "Normal" setting is the conventional gain adjustment method; the gain setting affects only echoes after setting.

The Gain Area setting is "Normal":

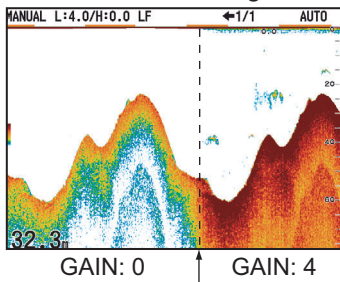

The gain setting changed from 0 to 4.

The "All" setting applies gain to both current and past echoes.

The Gain Area setting is "All":

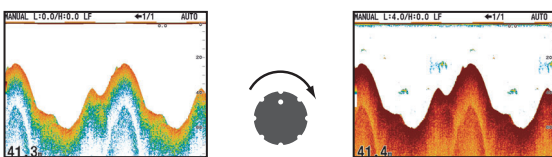

The gain setting changed from 0 to 4.

1.7.1 Selecting gain adjustment

1. Press the **GAIN HF** (for HF) or **GAIN LF** (for LF) control to open the Auto Gain setting window.

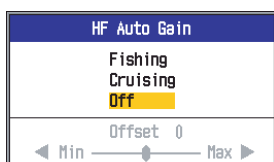

2. Use ▲ or ▼ to select Fishing, Cruising or Off as appropriate.

Fishing: This mode clearly displays weaker echoes and is for searching fish schools. "H (L):AF" is shown at the top left corner on the screen.

Cruising: This mode clearly displays stronger echoes (for example, bottom) and suppresses weak echoes. Use it for general cruising. "H (L):AC" is shown at the top left corner on the screen.

Off: Select to manually adjust gain.

3. For automatic operation (Fishing or Cruising), use the auto gain offset (range: -5 to +5) with ◀ or ▶.
4. Press the **ENTER** key.

1.7.2 Manual gain adjustment

The **GAIN HF** and **GAIN LF** controls adjust the sensitivity of the receiver. The setting range is 0.0 to 10, and the current setting is shown at the top of the screen as H (or L): XX (setting value).

Generally, use a higher setting for deep waters and a lower setting for shallow waters. In any case, adjust the controls so that a slight amount of noise remains on the screen.

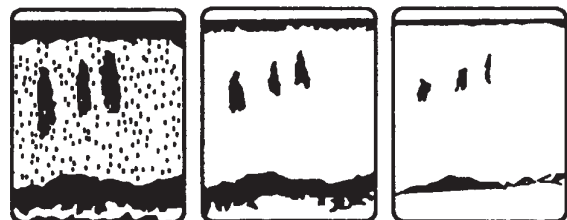

Gain too high Gain proper Gain too low



CAUTION

Adjust the gain properly. Incorrect gain may give wrong depth indication, which could result in grounding if the vessel is steered according to the depth indication.

1. OPERATION

1.8 Measuring Depth

The VRM (Variable Range Marker) measures the depth to fish schools, etc.

1. Use ▲ or ▼ to place the VRM on the object to measure depth.
2. Read the VRM depth just above the VRM.

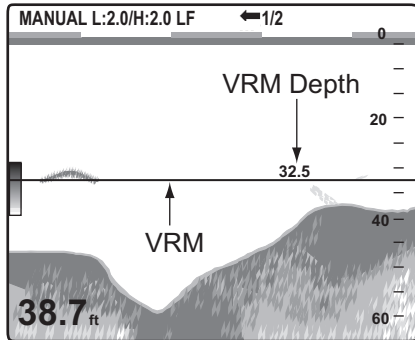

Note: The VRM is inoperative when the Nav Data is displayed.

1.9 Menu Operating Procedure

The FCV-295 has six menus: Sounder, TxRx, Display, Alarm, Data, and System (with nine sub menus).

Below is the basic menu operating procedure.

1. Press the **MENU/ESC** key to open the menu.

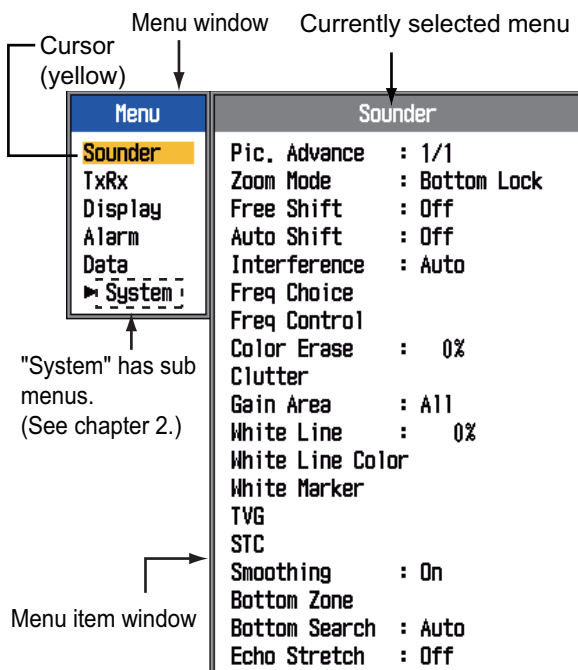

2. Use ▲ or ▼ to select a menu. The cursor (yellow) highlights current selection. The items in the right window change with menu selected.
3. Press the **ENTER** key to send the cursor to the menu item window. (Alternatively, you can press ►.) The cursor (yellow) shifts to the menu item window (right) and the color of the bar at the top of the menu item window changes from gray to blue to indicate that the menu item window is active.
4. Use ▲ or ▼ to select a menu item and press the **ENTER** key. The menu item's setting box or setting window appears.

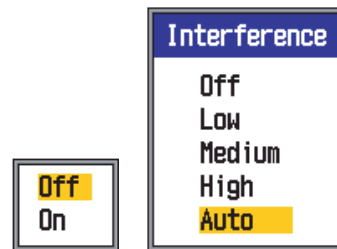

5. Use ▲ or ▼ to select an option.
6. Press the **ENTER** key (or ◀) to save the setting. The setting box or window disappears. To escape without changing setting, press the **MENU/ESC** key instead of the **ENTER** key.
7. To select another menu, press the **MENU/ESC** key. The cursor (yellow) moves to the menu window. You can also use ◀ to move the cursor.
8. Press the **MENU/ESC** key several times to close the menu.

1.10 Picture Advance Speed

The picture advance speed determines how quickly the vertical scan lines run across the screen. When choosing a picture advance speed, keep in mind that a fast advance speed will expand echoes horizontally on the screen and a slow advance speed will contract them. A fast advance speed is useful for observing the rugged bottom closely. A slow advance speed is useful for observing the smooth bottom.

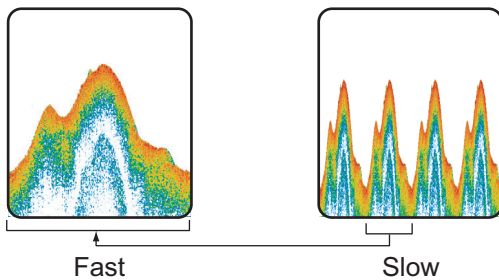

1. Press the **MENU/ESC** key to open the menu.
2. Use **▲** or **▼** to select Sounder and press the **ENTER** key.

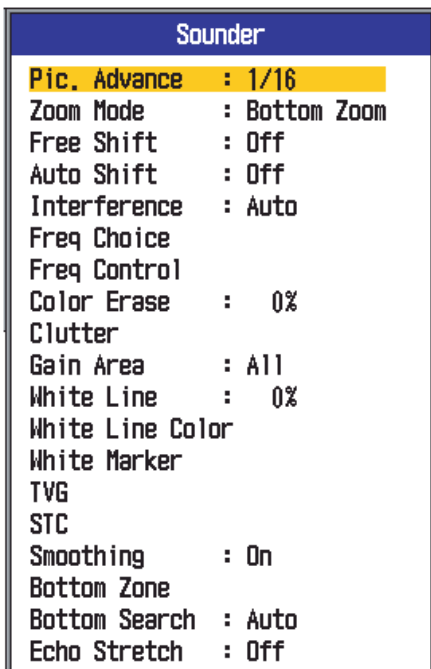

3. Use **▲** or **▼** to select Pic. Advance and press the **ENTER** key.

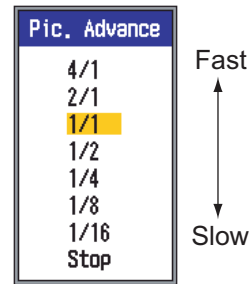

4. Use **▲** or **▼** to select picture advance speed desired and press the **ENTER** key. The fractions in the window indicate the number of scan lines produced per transmission. 1/16 is the slowest speed and 4/1 is the fastest speed. 1/16 means one scan line is produced every 16 transmissions. "Stop" freezes the display and is useful for taking a photo of the display.
5. Press the **MENU/ESC** key twice to finish.



CAUTION

Neither the picture nor the depth indication is updated when the picture is stopped. For those reasons, do not steer the vessel while monitoring the picture/depth indication when the picture is stopped.

Note: The picture advance direction is selectable. See sec. 1.19.3.

1.11 Rejecting Interference

Interference from other acoustic equipment operating nearby or other electronic equipment on your boat may show itself on the display as shown in the figure below. When this occurs use the interference rejector.

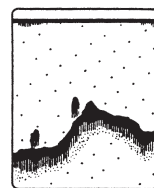

Interference from other sounder

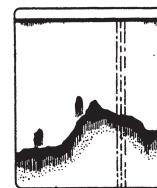

Electrical interference

1. OPERATION

1. Press the **MENU/ESC** key to open the menu.
2. Use **▲** or **▼** to select Sounder and press the **ENTER** key.
3. Use **▲** or **▼** to select Interference and press the **ENTER** key.

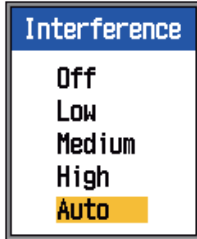

4. Use **▲** or **▼** to turn the interference rejector on or off and press the **ENTER** key.
Off: Turn off the interference rejector.
Low, Medium, High: High provides the greatest degree of suppression and Low provides the weakest.
Auto: Automatically reject interference.
5. Press the **MENU/ESC** key twice to close the window.

IMPORTANT

Turn off the interference rejector when no interference exists, so as not to miss small echoes.

1.12 Erasing Weak Echoes

Sediment in the water or reflections from plankton may be painted on the display in low intensity tones, as shown in the illustration below. You can remove these unwanted echoes with the Color Erase feature.

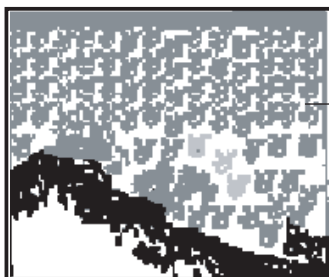

Weak echoes

1. Press the **MENU/ESC** key to open the menu.

2. Use **▲** or **▼** to select Sounder and press the **ENTER** key.
3. Use **▲** or **▼** to select Color Erase and press the **ENTER** key.

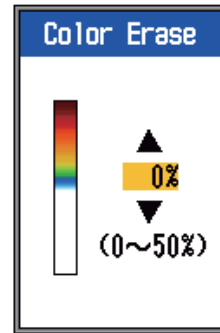

4. Use **▲** or **▼** to select the color to erase and press the **ENTER** key. The setting range is 0 to 50(%), in intervals of 5(%). The larger the setting value, the greater the number of colors that are erased.
5. Press the **MENU/ESC** key twice to close the menu.

1.13 Rejecting Clutter

Low intensity "speckles" may appear over most of screen. This is mainly due to sediment in the water or noise. These unwanted echoes can be rejected, when using the manual mode, by adjusting Clutter on the menu. Clutter is automatically adjusted in the auto gain mode.

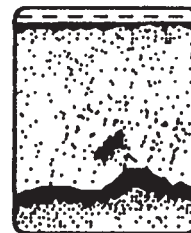

1. Press the **MENU/ESC** key to open the menu.
2. Use **▲** or **▼** to select Sounder and press the **ENTER** key.

- Use ▲ or ▼ to select Clutter and press the **ENTER** key.

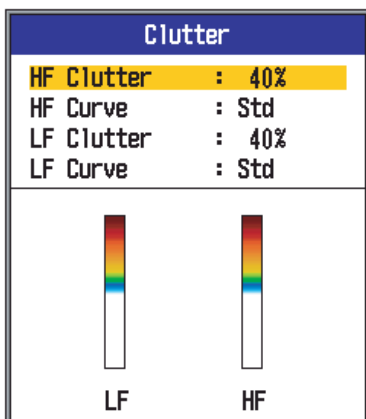

- Use ▲ or ▼ to select HF Curve or LF Curve as applicable and press the **ENTER** key. The setting box shown below appears.

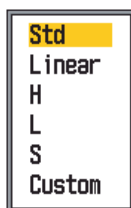

Std: Strong color echoes are displayed as is and weak color echoes are shown smaller, when the clutter level setting is raised.

Linear: All echoes are displayed smaller, when the clutter level setting is raised.

H: Show individual fish.

L: Show small targets such as plankton.

S: Display large individual fish located between the surface and midwater.

Custom: Emphasize strong-to-medium strength echoes. See User Clutter of sec. 2.2.1 "User menu description".

- Use ▲ or ▼ to select setting desired and press the **ENTER** key.
- Use ▲ or ▼ to select HF Clutter or LF Clutter as applicable and press the **ENTER** key.

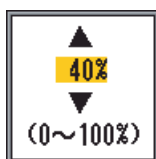

- Use ▲ or ▼ to set clutter level and press the [ENTER] key. The setting range is 0-100(%), in intervals of 10(%). The larger

the setting, the greater the degree of clutter rejection.

- Press the **MENU/ESC** key several times to close the window.

1.14 Adjusting TVG

A fish school at a deep depth is displayed in weak colors even if it is equal in strength to one in shallow waters. This is due to propagation attenuation of the ultrasonic wave. To compensate for this difference, use TVG. TVG automatically adjusts the gain with depth so that echoes of the same strength and different depths are shown in the same colors regardless of their depths. The gain is increased with depth to display echoes of equal strengths in the same colors. Furthermore, you can suppress unwanted echoes near the surface. For example, in the figure below, the TVG is set for 100 m and the TVG level is adjusted. Then, unwanted echoes at a distance less than 100 m are deleted and echoes at depths greater than 100 m are not affected.

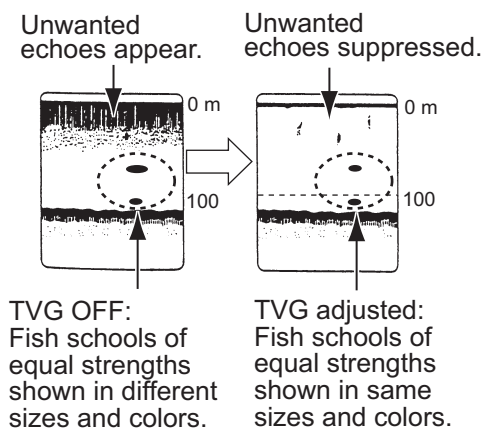

IMPORTANT

Do not set the TVG too high; close-range echoes may not be displayed. Carefully adjust the TVG while observing the display.

- Press the **MENU/ESC** key to open the menu.
- Use ▲ or ▼ to select Sounder and press the **ENTER** key.

1. OPERATION

- Use ▲ or ▼ to select TVG and press the **ENTER** key.

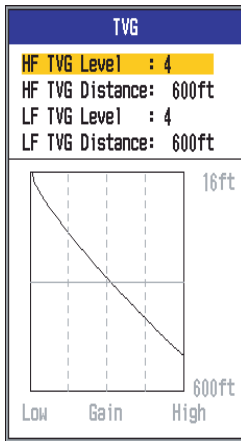

Default setting for FUNCTION control

- Use ▲ or ▼ to select HF TVG Distance or LF TVG Distance as applicable and press the **ENTER** key.

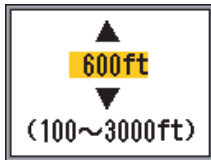

- Use ▲ or ▼ to set TVG distance.
 100-500 ft: 10 ft intervals
 500-1000 ft: 50 ft intervals
 1000-3000 ft: 100 ft intervals
- Press the **ENTER** key. The distance setting value in the TVG window changes to the one you set.
- Use ▲ or ▼ to select HF TVG Level or LF TVG Level as applicable and press the **ENTER** key.



- Use ▲ or ▼ to set TVG level and press the **ENTER** key. The higher the level the less the gain at near distance.
- Press the **MENU/ESC** key several times to close the window.

1.15 A-scope Display

This display shows echoes at each transmission with amplitudes and tone proportional to their intensities, on the right side of the screen. It is useful for estimating the type of fish school and bottom composition.

Note: In the horizontal split dual frequency display the A-scope display appears on both high and low frequency displays. In the vertical split dual frequency display the A-scope display only appears on the high frequency display.

- Press the **MENU/ESC** key to open the menu.
- Use ▲ or ▼ to select Display and press the **ENTER** key.

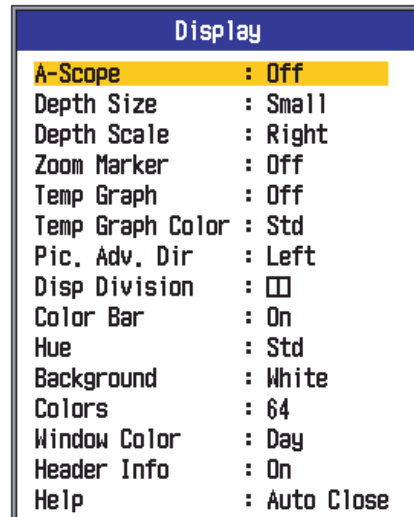

- Use ▲ or ▼ to select A-Scope and press the **ENTER** key.

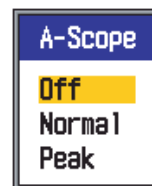

- Use ▲ or ▼ to select the A-scope presentation desired and press the **ENTER** key.
Normal: Display shows echoes at each transmission with amplitudes and tone proportional to their intensities.
Peak: "Normal" A-scope display plus peak-hold amplitude picture in dots for last five seconds.

- Press the **MENU/ESC** key twice to close the window.

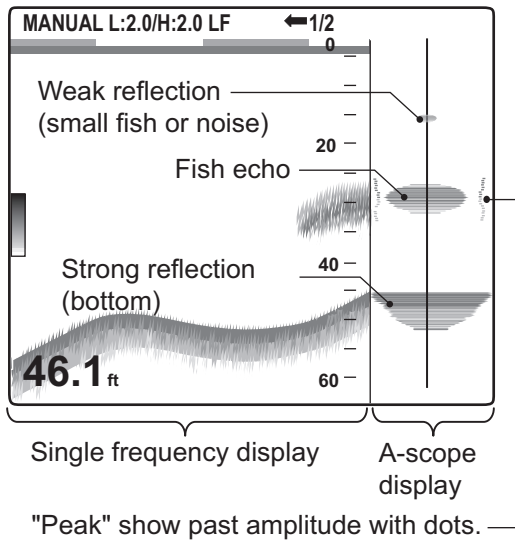

1.16 Alarms

The FCV-295 has six conditions which generate both audio and visual alarms: bottom alarm, normal fish alarm, bottom lock fish alarm, water temperature alarm, speed alarm and arrival alarm. (The water temperature, speed and arrival alarms require appropriate sensors.) When an alarm setting is violated the audio and visual alarms are released. You can silence the buzzer with any key. The visual alarm (icon) remains on the screen until the cause of the alarm is removed or the alarm is disabled.

Alarm icon (flashing)

An alarm icon appears when an alarm setting has been violated.

- : Bottom alarm
- : Fish alarm (defined area)
- : Fish alarm (all areas)
- : Fish alarm (bottom lock)
- : Temperature alarm (°F)
- : Speed alarm
- : Arrival alarm

Bottom alarm: The bottom alarm alerts you when the bottom is within the alarm range set. To activate the bottom alarm the depth must be displayed.

Fish (normal) alarm: The fish (normal) alarm tells you when an echo above a certain strength (selectable) is within the preset alarm range or an echo is anywhere between the transducer and the bottom.

Fish (bottom lock) alarm: The fish (bottom lock) alarm sounds when fish are within a certain distance from the bottom. Note that the bottom lock and bottom discrimination (1/2 or 1/3) displays must be turned on to use this alarm.

Water temperature alarm: The water temperature alarm alerts you when the water temperature is within (inside alarm) the alarm range set or under/over (outside alarm) the range set.

Speed alarm: The speed alarm alerts you when the ship's speed is within (inside alarm) or under/over (outside alarm) the preset speed.

Arrival alarm: The "Inside" arrival alarm alerts you when you approach to the destination waypoint by the distance set. Alternatively, the "Outside" arrival alarm alerts when your vessel travels a specific distance from the destination waypoint.

Activating an alarm

- Press the **MENU/ESC** key to open the menu.
- Use **▲** or **▼** to select Alarm and press the **ENTER** key.

```

Alarm
Bottom : Off
* { From : 0ft
  { Span : + 10ft
Fish(Normal) : Off
* { From : 0ft
  { Span : + 10ft
Fish(B/L) : Off
(Only at B/L Mode)
* { From : 0.0ft
  { Span : + 1.0ft
Fish Level : Medium
Temperature : Off
* { From : 65.0°F
  { Span : + 1.0°F
Speed : Off
* { From : 0.0kt
  { Span : + 1.0kt
Arrival Alarm : Off
* { Radius : 0.01nm
    
```

*: Value not adjustable when alarm is inactive.

1. OPERATION

3. Use ▲ or ▼ to select an alarm and press the **ENTER** key.

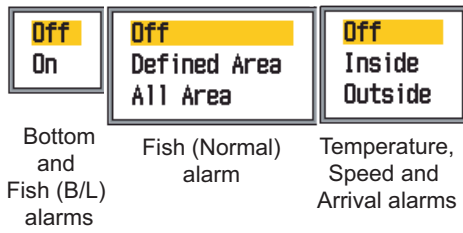

4. Use ▲ or ▼ to select alarm type:
On: Bottom and Fish (B/L) alarms
Defined Area/All Area: Fish (Normal) alarm
Inside/Outside: Temperature, Speed and Arrival alarms
Inside: Alarm generated when speed, water temperature or arrival distance is within the range set.
Outside: Alarm generated when speed, water temperature or arrival distance is outside the range set.
5. Press the **ENTER** key. For "All Area" Fish (Normal) alarm, go to step 13. For Arrival alarm, go to step 10.
6. Use ▲ or ▼ to select From.
7. Press the **ENTER** key.

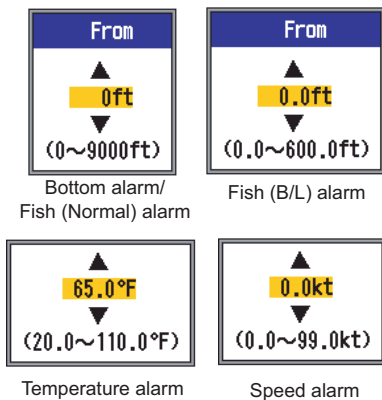

8. Use ▼ to set starting depth, temperature or speed as appropriate and press the **ENTER** key. For Bottom and Fish (Normal), the starting depth is the range from

the transducer, and for Fish (B/L), from the bottom.

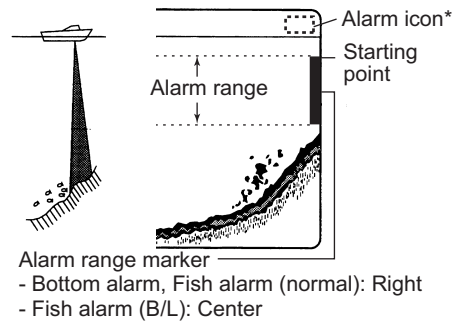

9. Press the **ENTER** key.
10. Use ▼ to select Span (or Radius in case of Arrival) and press the **ENTER** key.
11. Use ▲ or ▼ to set the range of depth, temperature, speed or distance as appropriate. To shorten the alarm range marker use ▲ and to lengthen it use ▼.
12. For the bottom alarm, temperature alarm, speed alarm or arrival alarm, press the [ENTER] key to finish, and then go to step 16. For a fish alarm, press the **ENTER** key and go to step 13.
13. Use ▲ or ▼ to select Fish Level and press the **ENTER** key.



14. Use ▲ or ▼ to select the echo strength level which will trigger the fish alarm.
Weak: Light-blue or stronger echoes
Medium: Yellow or stronger echoes
Strong: Red and reddish-brown echoes
15. Press the **ENTER** key.
16. Press the **MENU/ESC** key twice to close the menu.

Note: To disable an alarm, select Off at step 4 in the above procedure.

1.17 FUNCTION Control

The **FUNCTION** control provides for instant display of a user-defined option's window, chosen with "FUNC Key" on the Key menu. 14 items are available: Pic. Advance, Interference, Color Erase, Clutter, White Line, White Marker, TVG (default setting), STC, Bottom Zone, A-Scope, Split Range, Auto Shift, Freq Choice and Freq Control.

1.17.1 Using the FUNCTION control

1. Press the **FUNCTION** control to open the setting window registered. (This window can also be opened by rotating the control.)

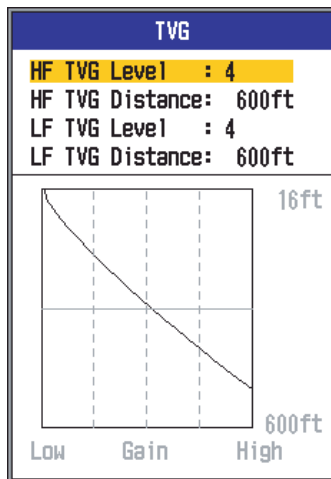

Default setting for FUNCTION control

2. Change setting as applicable.

1.17.2 Programming the FUNCTION control

1. Push and hold down the **FUNCTION** control until the FUNC key setting window appears.

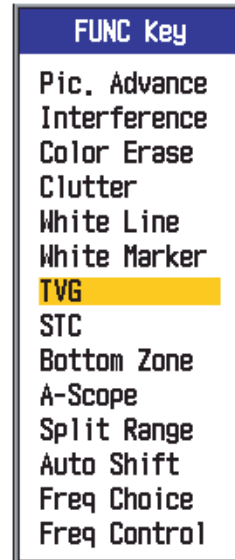

2. Use ▲ or ▼ (or rotate the **FUNCTION** control) to select the item you want to program to the **FUNCTION** control.
3. Press the **ENTER** key or **FUNCTION** control to confirm your selection.

1.18 Waypoints

Waypoints are used to:

- Record the position of an important echo as a waypoint, and 20 points can be saved.
- Output a waypoint position to a chart plotter to mark position on its screen.
- Find range, bearing and time-to-go to a location (waypoint).

This feature requires position data, fed from a GPS navigator.

1.18.1 Entering a waypoint

There are two ways to enter a waypoint: directly enter it from the screen, or manually enter its latitude and longitude coordinates from the menu.

Entering a waypoint from the screen

1. Press the **MARK** key. The cursor appears along with waypoint entry instructions. To enter a waypoint at current position, go to step 3.

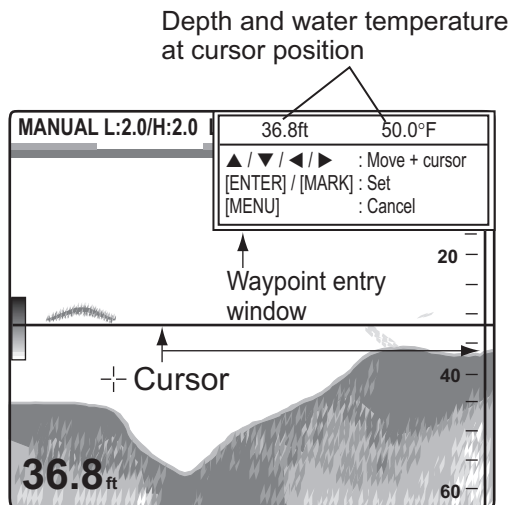

Note: If there is no position data, the message "No position data" appears.

2. Use the Cursor pad to set the cursor where desired. Picture does not advance until step 3 is completed, and the instruction window is integrated into the data box.

You can choose the echo to show on the A-scope display with the cursor. This is useful for finding the intensity of a specific echo.

3. Press the **MARK** or the **ENTER** key to save the position. A red vertical line appears at the position. The waypoint is named automatically with the next sequential waypoint number. If you want to change the waypoint name, go to step 4. Otherwise, go to step 6.

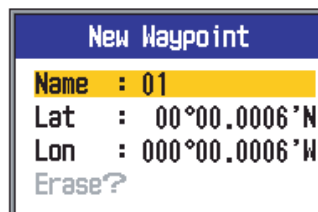

Note 1: When TLL or FURUNO-TLL is selected at TLL Output on the NMEA menu of the System menu, the latitude and longitude position at the cursor position is output to a chart plotter.

Note 2: Up to 20 waypoints can be registered. When you attempt to enter more than 20, the message "Already entered 20 waypoints. No more waypoint can be entered." appears. To enter another waypoint, delete an unnecessary waypoint, referring to section 1.18.3.

4. Press the **ENTER** key to open the waypoint name entry box.



5. Enter the waypoint name (max. 8 characters) as follows:
 - 1) Use ▲ or ▼ to set character. Press ▲ to select character in order of 0→1→...→9→- →A→...→Z→_ →0→... Use ▼ to select character reverse of that order.
 - 2) Use ▶ to shift the cursor.
 - 3) Repeat steps 1) and 2) to complete the name and finally press the **ENTER** key.
6. Press the **MENU/ESC** key to close the window.

Entering a waypoint by manual entry of position

1. Press the **MENU/ESC** key to open the menu.
2. Use **▲** or **▼** to select Data and press the **ENTER** key.

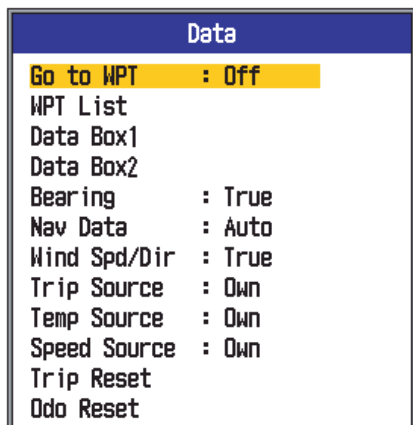

3. Use **▲** or **▼** to select WPT List and press the **ENTER** key.

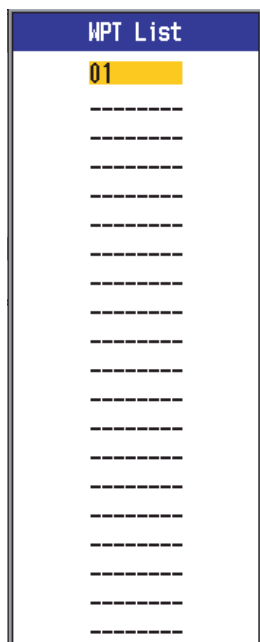

4. Use **▲** or **▼** to select an empty waypoint and press the **ENTER** key. The waypoint setting window appears, showing current position in latitude and longitude.
5. Use **▲** or **▼** to select item desired and press the **ENTER** key.



For name

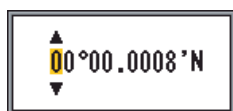

For L/L (ex. latitude)

6. Enter latitude and longitude, similar to how entered waypoint name.
7. Press the **MENU/ESC** key to register the waypoint.
8. Press the **MENU/ESC** key several times to close the window.

1.18.2 Editing waypoints

1. Press the **MENU/ESC** key to open the menu.
2. Use **▲** or **▼** to select Data and press the **ENTER** key.
3. Use **▲** or **▼** to select WPT List and press the **ENTER** key.
4. Use **▲** or **▼** to select the waypoint to edit and press the **ENTER** key. The waypoint setting window appears.
5. Use **▲** or **▼** to select the item to edit.
6. Edit item as appropriate.
7. Press the **MENU/ESC** key several times to close the window.

1.18.3 Erasing waypoints

A waypoint currently selected as destination waypoint cannot be erased.

1. Press the **MENU/ESC** key to open the menu.
2. Use **▲** or **▼** to select Data and press the **ENTER** key.
3. Use **▲** or **▼** to select WPT List and press the **ENTER** key.
4. Use **▲** or **▼** to select the waypoint to erase and press the **ENTER** key.
5. Use **▲** or **▼** to select Erase? and press the **ENTER** key.
6. Use **▲** or **▼** to select Yes and press the **ENTER** key.
7. Press the **MENU/ESC** key three times to close the window.

1. OPERATION

1.18.4 Setting destination waypoint

Set a destination waypoint to find range, bearing and time-to-go to that point. Range, bearing and time-to-go (to the waypoint) are shown on the nav data display. See sec. 2.2.2.

1. Press the **MENU/ESC** key to open the menu.
2. Use **▲** or **▼** to select Data and press the **ENTER** key.
3. Use **▲** or **▼** to select Go To WPT and press the **ENTER** key.
4. Use **▲** or **▼** to select a waypoint and press the **ENTER** key.
5. Press the **MENU/ESC** key twice to close the window.

1.19 Menu Description

This section describes menu items not previously mentioned. For the System menu, see chapter 2.

1.19.1 Sounder menu

Sounder	
Pic. Advance	: 1/16
Zoom Mode	: Bottom Zoom
Free Shift	: Off
Auto Shift	: Off
Interference	: Auto
Freq Choice	
Freq Control	
Color Erase	: 0%
Clutter	
Gain Area	: All
White Line	: 0%
White Line Color	
White Marker	
TVG	
STC	
Smoothing	: On
Bottom Zone	
Bottom Search	: Auto
Echo Stretch	: Off

Zoom Mode: Select the zoom display to show, among bottom lock, bottom zoom, marker zoom and bottom discrimination (1/2, 1/3), when "zoom" is selected with the **MODE** control.

Free Shift: Turn on/off independent range shift. Select **Off** to apply the same shift value to all ranges. To set range shift independently on each range, select **On**. This feature is inoperative when auto range or auto shift is active.

Auto Shift: Turn the auto shift feature on or off. Select **Off** to shift the display manually (with **▲** or **▼**). **On** automatically tracks the bottom echo to keep it on the bottom half of the display. For example, the distance to the bottom is 350 ft and the range is set to 60 ft. Then, auto shift automatically places the bottom echo on the display, without changing the range. "AUTO_S" appears at the upper left corner when auto shift is active. Shift **▲** and **▼** are inoperative when auto shift is active.

Note 1: Auto shift is inoperative when auto range is active.

Note 2: The bottom echo must be displayed in reddish brown or red in order for auto shift to function.

Freq. Choice: You can register up to four different frequencies for a single transducer, following the procedure in "Freq. Control" in the Sounder menu. Then, you select here the high and low frequencies to use.

1. Select Freq. Choice and press the **ENTER** key. The choices available depend on the transducers you have. The choices below are for 200 kHz (high frequency) and 50 kHz (low frequency).

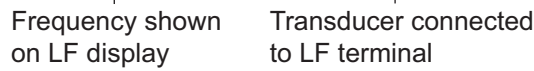
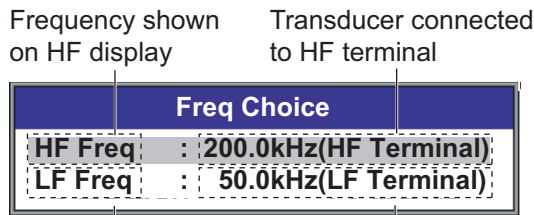

(1) 200 kHz trans. connected to HF terminal; 50 kHz trans. connected to LF terminal

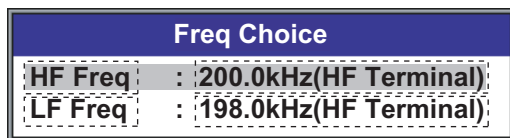

(2) 200 kHz trans. connected to HF terminal; no trans. connected to LF terminal

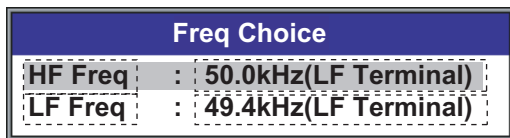

(3) 50 kHz trans. connected to LF terminal; no trans. connected to HF terminal

2. Use ▲ or ▼ to select HF Freq or LF Freq as appropriate and press the **ENTER** key. The frequencies preset with Freq Control are shown.

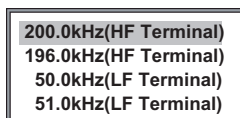

(1) Configuration

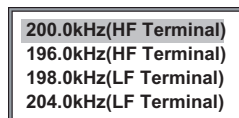

(2) Configuration

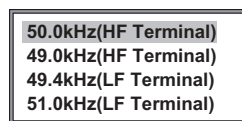

(3) Configuration

3. Use ▲ or ▼ to select applicable frequency and press the **ENTER** key. The picture

for the frequency selected here is shown on the display.

Freq Control: Four different transducer frequencies and frequency adjustment range are automatically set at installation. However, the range of frequency adjustment for each frequency may be different depending on installation characteristics. For example, for a 200 kHz frequency transducer, the default frequencies are 200 kHz, 196 kHz, 198 kHz and 204 kHz. If those frequencies are not suitable for your use, you can change them. Further, in case of a wide-bandwidth transducer, frequencies may be chosen from the available frequency range. This allows you to have multiple frequencies for a single transducer. For example, if you have the transducer 82B-35R, you can register frequencies between 66 kHz and 109 kHz. The frequencies registered here may be selected at Freq Choice in the Sounder menu.

Set transducer frequency keeping in mind these considerations.

- Set frequency which is suitable for detecting targeted fish.
- Shift frequency so as to reduce interference.
- Lower frequency to increase detection range.
- Raise frequency to improve resolution.

1. Choose Freq. Control and press the **ENTER** key. The contents of the setting window depend on your system configuration. In the example below, a 200 kHz transducer is connected to the HF terminal and a 50 kHz transducer is connected to the LF terminal.

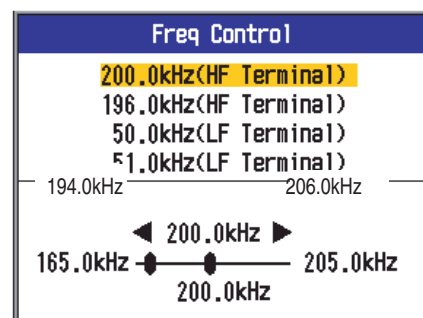

1. OPERATION

- Use ▲ or ▼ to select a frequency and press the **ENTER** key.



- Use ▲ or ▼ to select a frequency terminal and press the **ENTER** key. To adjust the frequency of the transducer connected to the HF terminal, select HF terminal; select LF terminal to adjust the frequency of the transducer connected to the LF terminal.

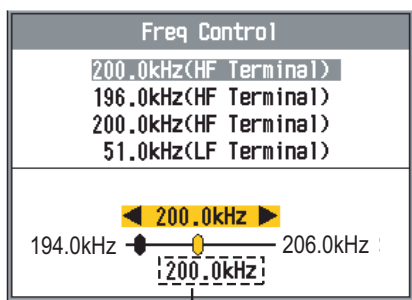

Frequency set at installation

- Use ◀ or ▶ to adjust the frequency. The adjustment range depends on the transducer connected.
- Press the **ENTER** key.
- To set another frequency, do steps 2-5 in this procedure.

Gain Area: Select how to apply gain. **All** applies gain to both past and current echoes. **Normal** applies gain to only echoes after setting; past echoes are not affected.

Note that the current display is erased when changing this setting.

White Line: The white line helps you distinguish bottom fish from the bottom by tracing a line, in white or color desired, just above the bottom contour. This function is not only useful for discriminating bottom fish but is also valuable for judging fish school density. The setting range is 0%-100%, in intervals of 10%. The higher the value, the thicker the line.

- Select White Line and press the **ENTER** key.

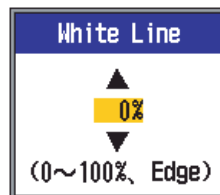

- Use ▲ or ▼ to set the width and press the **ENTER** key. The higher the figure, the wider the width of the line. The option "Edge" paints a very thin line above the bottom contour regardless of gain setting or display color.

White Line Color: Choose the color for the white line.

- Select White Line Color and press the **ENTER** key.

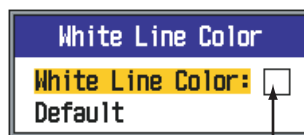

Current white line color

- With White Line Color selected, press the **ENTER** key.

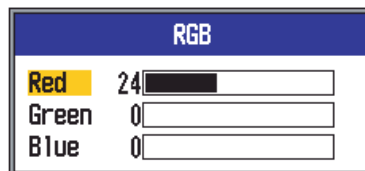

- Use ▲ or ▼ to select the color to change.
- Use ◀ or ▶ to adjust (range: 0-63) the color.
- Set all colors as appropriate.
- Press the **ENTER** key to finish.

To restore default white line settings, select Default at step 1 and press the **ENTER** key. Press ▲ or ▼ to select Yes and press the **ENTER** key.

White Marker: Display a specific echo color in white. This feature is useful for emphasizing echoes having a specific strength.

1. Select White Marker and press the **ENTER** key.

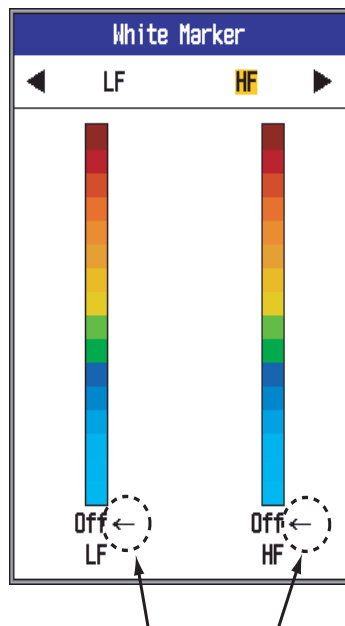

Color selected with arrow is shown in white.

2. Use ◀ or ▶ to select high or low frequency as appropriate.
3. Use ▲ or ▼ to select the color to display in white. For example, to display the bottom echo in white, select the topmost color on the color bar.
4. Press the **ENTER** key.

STC: Delete unwanted echoes (plankton, air bubbles, etc.) near the surface. This is useful to clear the surface of unwanted echoes to look for surface fish. The setting range is 0-10, and 0 is Off. The larger the value, the more surface echoes are erased. In setting 10, STC deletes unwanted echoes from the surface to about 16 ft. Avoid setting the STC too high; fish echoes near the surface may be erased.

Smoothing: If echoes appear like "patchwork," turn this feature on to smooth them.

Bottom Zone: Select the area where to show the bottom echo, when Auto Range is active.

1. Choose Bottom Zone and press the **ENTER** key.

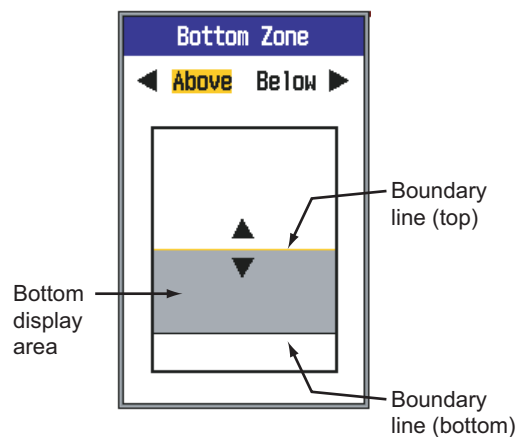

2. Use ◀ or ▶ to select the boundary line to adjust.
3. Use ▲ or ▼ to adjust the boundary line.

Bottom Search: Select the frequency to use to detect depth when using the dual frequency display. The choices are **HF**, **LF**, and **Auto**. **Auto** gives priority to a frequency which is giving the most accurate depth data.

Echo Stretch: Turn this feature on to stretch the tail of echoes. This is useful when you are trying to find individual fish within a layer of plankton.

1.19.2 Tx/Rx menu

TxRx	
Tx Power	: Auto
Tx Rate	: Max
[HF]	
Tx Pulse Edge	: Off
Tx Pulse	: Std
Pulse Length	: 0.05msec
Rx Band	: Std
[LF]	
Tx Pulse Edge	: Off
Tx Pulse	: Std
Pulse Length	: 0.05msec
Rx Band	: Std
Target Echo	: Normal

Tx Power: Interference may appear on the screen when an echo sounder having the same frequency as your own is being operated in the vicinity of your vessel. In this case, lower your Tx power and contact the vessel to request them to reduce their Tx power. Tx power is available in Off, Min, 1-10, and Auto. **Off** turns off transmission. **Min** sets minimum Tx power. **Auto** automatically adjusts Tx power. **1-10** sets desired Tx power; the higher the value, the more the Tx power. When Tx power is reduced (Off, Min, 1-9), the indication "P/R" appears at the top of the display.

Tx Rate: Changes pulse repetition rate, in 20 levels. Normally, the highest rate (20) is used. When in shallow waters second reflection echoes may appear between surface and actual bottom echo. In this case, lower the Tx rate level. **Max** changes the Tx rate automatically. **S** activates the ship's speed dependent mode, where the TX rate changes automatically with ship's speed. (Requires ship's speed input.)

Tx Pulse Edge (HF/LF): Turn on to suppress interference to other acoustic equipment (fish finders, scanning sonars, etc.), your own and others.

Tx Pulse (HF/LF): Pulse width changes according to range and shift values. When long range detection is your objective select a long pulse length. For better resolution, choose a shorter pulse. **Short 1** raises the detection resolution, however, detection range is shorter (pulse length is about 1/4 of Std) than the

Std setting. **Short 2** raises the detection resolution, however, detection range is shorter (pulse length is about 1/2 of Std) than the Std setting. **Std** is the standard pulse length, and is suitable for general use. **Long** increases the detection range but resolution is two times lower compared to the Std pulse length. **Manual** enables manual setting of pulse length, at "Pulse Length."

Pulse Length (HF/LF): Operative when Manual is selected at Tx Pulse. A small value gives better detection resolution, however detection range is shorter. On the other hand, a large value gives better detection range but resolution is lower. The setting range is 0.05 - 5.0 (msec).

Rx Band (LF/HF): Rx bandwidth is automatically set according to Tx pulse length. Normally the **Std** position provides good performance. If noise is a problem switch to **Narrow**. For better resolution, select **Wide**.

Target Echo: Set fishing objective. **Normal** is for general purpose fishing. **Surface** is for detecting surface fish. Pulse repetition rate is higher than "Normal" on the 1kW and 2kW transducers that are programmed into the menu. **Squid** detects squid and other individual fish. These items are automatically set: Tx Pulse, Short 1; Echo Stretch, ON, and Smoothing, Off. **Deep Sea** is the same as Normal.

1.19.3 Display menu

Display	
A-Scope	: Off
Depth Size	: Small
Depth Scale	: Right
Zoom Marker	: Off
Temp Graph	: Off
Temp Graph Color	: Std
Pic. Adv. Dir	: Left
Disp Division	: <input type="checkbox"/>
Color Bar	: On
Hue	: Std
Background	: White
Colors	: 64
Window Color	: Day
Header Info	: On
Help	: Auto Close

Depth Size: Change the size of the depth indication, to **Small, Middle** or **Large**. **Off** turns off the depth indication.

Depth Scale: Select where to display the depth scale, **Right** or **Center**. **Off** turns off the depth scale.

Zoom Marker: Turn the zoom marker on or off on the zoom displays.

Temp Graph: Turn the temperature graph on or off and select graph range, from **Narrow** or **Wide**. **Narrow** is 16°F and **Wide** is 32°F.

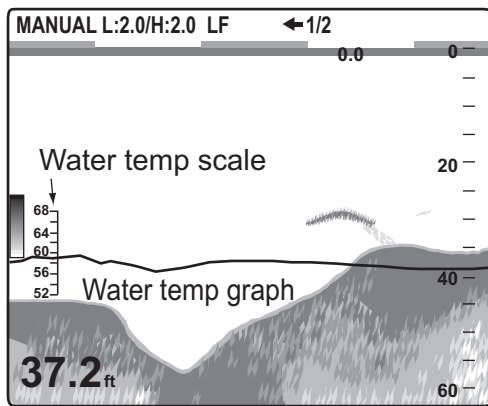

Temp Graph Color: Select water temperature graph color, among standard, white, red, black, and yellow.

Pic. Adv. Dir: Select picture advance direction. **Left** advances the picture right to left. **Right** advances the picture left to right. **L/R** advances the picture both leftward and rightward, starting from the center of the screen. (Left direction in single frequency display, horizontal split.)

Disp Division: Select display division in dual frequency and combination displays (zoom+normal). The choices are shown in the illustration below.

- : Horizontal split
- : Vertical split

Color Bar: Turn the color bar on or off.

Hue: Change the color arrangement. The choices are Std, Hue1 thru Hue6, and Custom. As you move through the selections you can see the color arrangement at the right side of the screen.

Background: Change the background to suit your current environment. The choices are white, light blue, blue, dark blue, and black. This feature is inoperative when Hue is selected to Custom.

Colors: Select the number of colors to display. The choices are 8, 16, and 64.

Window Color: Select the background color for the menu window. **Day** is white background. **Night** is black background, with brilliance set to "2."

Header Info: Turn the header info on or off.



Help: Help turns the help display on or off. **Off** turns off help. **On** turns on help. **Auto Close** automatically closes the help display when there is no operation within six seconds.

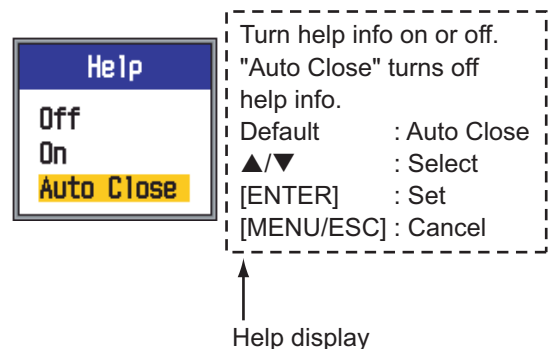

1.19.4 Data menu

The Data menu sets up data received from external equipment.

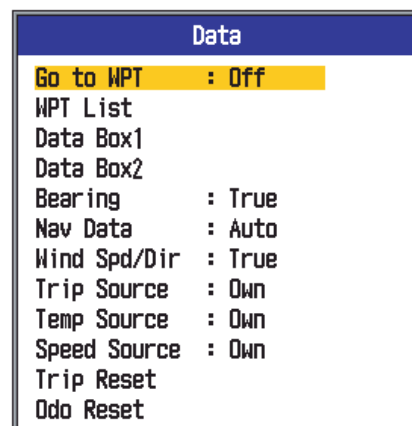

1. OPERATION

Data Box1, Data Box2: Turn on to display data at the upper left corner on the display. If several data items are turned on, they are displayed alternately at the interval (default: 4 s) chosen with Switching Cycle. Data other than Depth, Range, Timer, Scroll Time and Battery require appropriate sensor.

Data box 1 information → 50.8_{ft}

Data box 2 information → 16.1_{kt SOG}

1. Select Data Box1 and press the **ENTER** key.

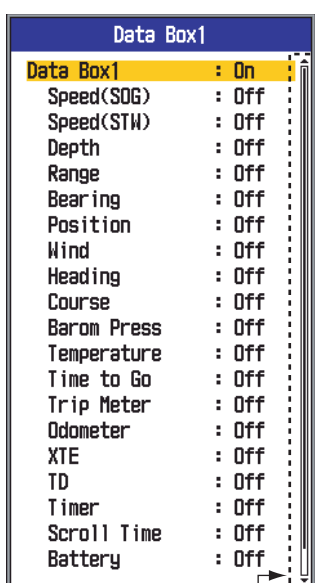

You can see the hidden menu by using ▲ or ▼.

Timer counts time up from 0H00M to 99H59M. Can be reset to zero with the [MARK] key.

2. With Data Box1 selected, press the **ENTER** key.



3. Press ▲ or ▼ to select On if it is not already selected. All menu items are shown in black, meaning they are available for selection.
4. Use ▲ or ▼ to select a data and then press the **ENTER** key.
5. Use ▲ or ▼ to select Off or On as appropriate and press the **ENTER** key.

6. Repeat steps 4 and 5 as necessary.
7. Use ▲ or ▼ to select Switching Cycle and then press the **ENTER** key.

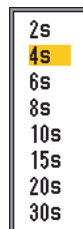

8. Use ▲ or ▼ to select desired display interval and then press the **ENTER** key.
9. Set up data box 2 similar to how you did data box 1.

Bearing: Select how to display bearing data, fed from navigator. The choices are true and magnetic.

Nav Data: Select source of position data, among Auto, GPS and Loran C. **Auto** selects navigator in order of accuracy in case of multiple navigators. The order is GPS followed by Loran C.

Wind Spd/Dir: Display wind speed and direction data in True or Apparent. The **apparent wind** is the actual flow of air acting upon a sail, or the wind as it appears to the sailor. The **true wind** is the wind seen by a stationary observer in velocity and direction.

Trip Source: Select source for trip data calculation. The choices are Own (internal speed sensor) and NMEA (speed data from external navigator).

Temp Source: Select source for water temperature data. The choices are Own (internal temperature sensor) and NMEA (temperature data from external navigator).

Speed Source: Select source for speed data. The choices are Own (internal speed sensor) and NMEA (speed data from external navigator).

Trip Reset: Select Yes to reset trip meter to zero. A few beeps sound after resetting is completed.

Odo Reset: Select Yes to reset the odometer to zero. A few beeps sound after resetting is completed.

2. SYSTEM MENU

2.1 How to Open the System Menu

Press the **MENU/ESC** key to open the menu, then press **▲** or **▼** to select System.

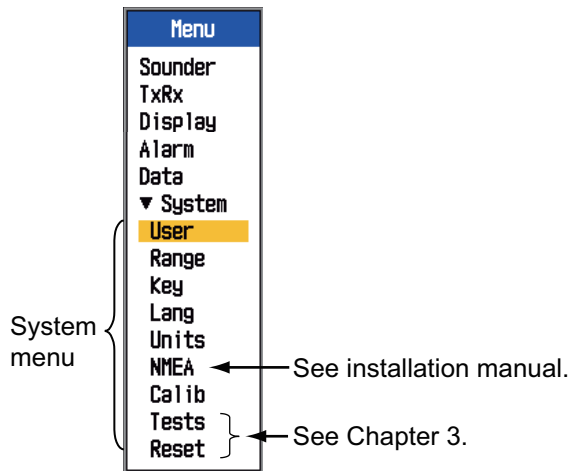

2.2 User Menu

The User menu mainly provides items for arrangement of the user picture.

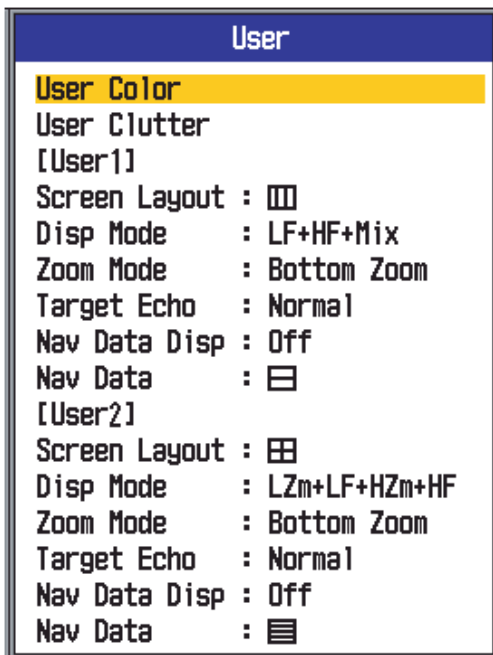

2.2.1 User menu description

User Color

Arrange the display colors to your liking by changing the color arrangement on the color bar.

1. Select User Color and press the **ENTER** key to show the user color bar.

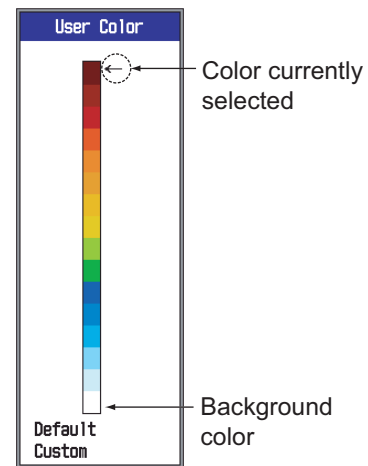

2. Press **▲** or **▼** to select the color to adjust and press the **ENTER** key. The RGB adjustment window appears.

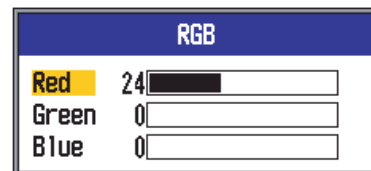

3. Press **▲** or **▼** to select the color to adjust.
4. Press **◀** or **▶** to adjust color (0-63).
5. Press the **ENTER** key to finish setting.
6. To enable user colors, press **▲** or **▼** several times to select Custom at the bottom of the color bar and then press the **ENTER** key.
7. Press **▲** or **▼** to select Yes and then press the **ENTER** key. Hue on the Display menu is automatically set to custom and Background on the same menu becomes inoperative.
8. Press the **MENU/ESC** key three times to quit the menu.

2. SYSTEM MENU

User Clutter

Select the colors to reject with the clutter rejector.

1. Select User Clutter and press the **ENTER** key to show the user clutter color bar.

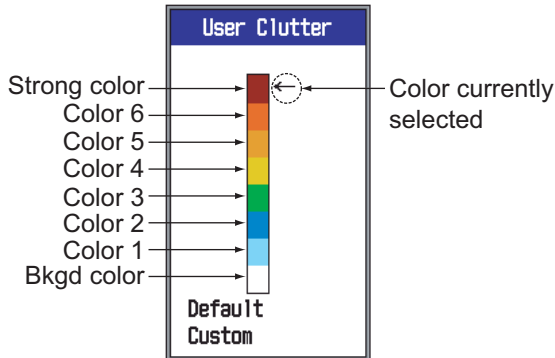

2. Use **▲** or **▼** to select the color to adjust and then press the **ENTER** key.
3. Use **▲** or **▼** to set value, referring to the table below.



If you want to...	then set...
emphasize strong colors (reddish-brown, red)	Strong color- Color-6: Large value Color-5 to Color-1: Small value
emphasize middle colors (yellow, green)	Strong color to Color-5: Small value Color-4 and Color-3: Large value Color-2 and Color-1: Small value
remove the weakest color	Color-1: Small value

4. Press the **ENTER** key.
5. To set another color, repeat steps 2-4.
6. To enable the user clutter settings, press **▲** or **▼** several times to select Custom at the bottom of the color bar and then press the **ENTER** key.
7. Press **▲** or **▼** to select Yes and press the **ENTER** key. (The setting for HF Curve and/or LF Curve in Clutter on the Sounder menu automatically becomes "Custom".)
8. Press the **MENU/ESC** key three times to quit the menu.

User 1, User 2

Define what to show on the two user display mode screens, selectable with the **MODE** control.

Screen Layout: Select the screen layout, from among the following eight choices.

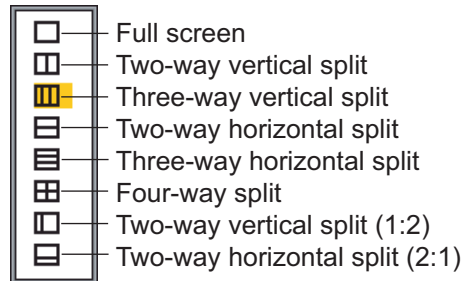

Display Mode: Select the displays to show. The choices depend on the setting of Screen Layout.

- : HF; LF; HZm; LZm; Mix
- , : HZm+HF; LZm+LF; LF+HF; LZm+HZm; HF+Mix; LF+Mix; HF2+HF1; LF2+LF1
- , : LF+HZm+HF; LZm+LF+HF; LF+HF+Mix
- : LZm+LF+HZm+HF
- : HZm+HF; HZm+LF; LF+HF; LZm+HZm; HF+Mix; LF+Mix
- : HZm+HF; LZm+LF

The screen modes are shown as follows:

HF: High Frequency

LF: Low Frequency

Zm: Zoom

Mix: Mix display

HF1, HF2, LF1, LF2: 1 and 2 show the same picture. Gain can be adjusted independently for each.

Display	Control for adjusting gain
HF1	GAIN HF control
HF2	GAIN LF control
LF1	GAIN LF control
LF2	GAIN HF control

About the mix display

The mix display compares echo intensity between low and high frequencies, and displays echoes from tiny fish in discriminative colors. This is done by utilizing the fact that tiny fish return a stronger echo against a high frequency rather than a low frequency. It works as follows.

- If a high frequency echo is stronger than the corresponding echo on the low frequency, the high frequency echo is displayed.
- If the low frequency echo is stronger than or equal to the high frequency echo, it is less likely to be a tiny fish and therefore is displayed in blue.
- If the echoes on both frequencies have the intensity corresponding to reddish-brown or red, they are displayed in reddish brown or red. This is necessary to display the zero line and bottom in reddish-brown or red.

In other words, the echoes displayed in orange thru light-blue are considered to be tiny fish such as whitebait.

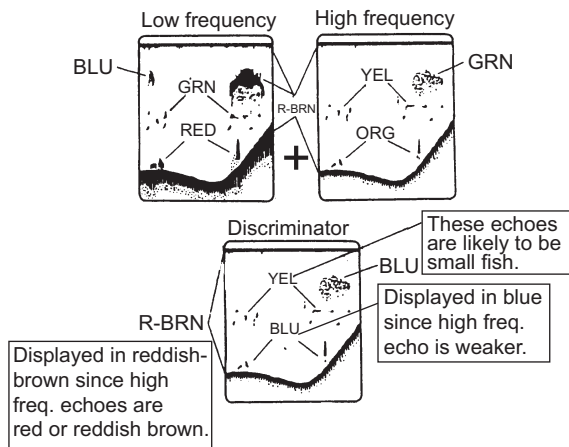

Zoom Mode: Select the zoom display to show, among bottom lock, bottom zoom, marker zoom, discrim 1/2 and discrim 1/3. See sec. 1.4.3 "Zoom display".

Target Echo: Set fishing objective. **Normal** is for general purpose fishing. **Surface** is for detecting surface fish. Pulse repetition rate is higher than "Normal" on the 1kW and 2kW transducers that are programmed into the menu. **Squid** detects squid and other individual fish. These items are automatically set: Tx Pulse, Short 1; Echo Stretch, ON, and

Smoothing, Off. **Deep Sea** is the same as Normal.

Nav Data Disp: Turn the nav data display On or Off and select character size, from large or small.



Nav Data: Select the quantity of nav data to show, at the upper left corner of the display. The choices are two, three and four items, as shown below.



2. SYSTEM MENU

2.2.2 Selecting data for nav data displays

- Operate the **MODE** control to select USER-1 or USER-2, whichever is set up to show nav data.

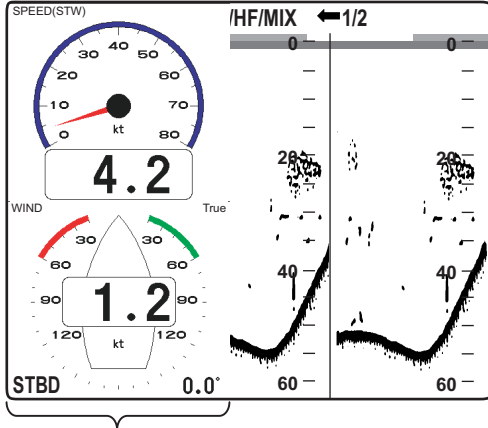

Nav data display

- Use ▲ or ▼ to select a data display window.
- Use ◀ or ▶ to select the nav data item to display. Availability depends on how much nav data is displayed, as shown below.

(1)	(3)	(6)
(2)	(4)	(7)
	(5)	(8)
Two-data display	Three-data display	Four-data display

Items displayable in (1) - (3): speed (STW)*, wind speed and direction*, destination waypoint data*, compass*, heading*, depth, position, course, range and bearing, trip meter, odometer, water temperature, air pressure, time-to-go to destination waypoint, XTE*, speed (SOG)*

Items displayable in (4) - (9): depth, position, speed (SOG), speed (STW), course, range and bearing, trip meter, odometer, water temperature, heading, wind speed, wind direction, air pressure, time-to-go to destination waypoint, XTE

* = Graphic display

- Press the **ENTER** key.

Note: When data is lost 30 sec., the display shows “- -” at the location where there is no data.

Item	Necessary data
Latitude/Longitude, Waypoint, Course, Range/Bearing, TTG, XTE	Latitude and longitude
Compass, Heading	Heading
Wind Speed/Direction, Atmospheric Pressure	Wind Indicator, Barometer

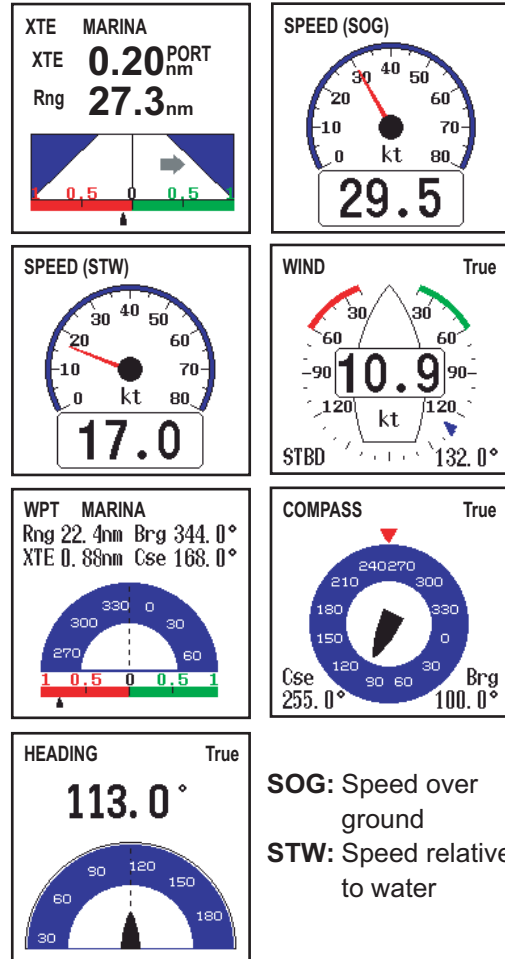

SOG: Speed over ground
STW: Speed relative to water

DEPTH 1234 ft	POSITION 2345.6789 _N 12345.6789 _E	SPEED (SOG) 12.3 kt
SPEED (STW) 12.3 kt	COURSE True** 123.4 °	RNG/BRG*** 1234 nm 123.4 °
TRIP METER 1234 nm	ODOMETER 1234 nm	TEMP 123.4 °F
HEADING True** 123.4 °	WIND SPEED True* 12.3 kt	WIND DIR. True* 123.4 °
BAROM PRESS 1234 hPa	TIME TO GO 12 H 34 M	XTE 01 ▶ 0.50 nm ^{STBD}

* APP or TRUE, depending on menu setting.
 ** TRUE or MAG depending on menu setting.
 *** To destination waypoint.
 ▶(green): starboard ◀(red): port

2.3 Range Menu

The Range menu is where you can pre-set basic ranges, zoom range, bottom lock range, and turn independent range adjustment on or off. The default values are suitable for most fishing applications, however you may wish to change pre-set ranges to suit your needs. Note that when the depth unit is changed all range settings are restored to default. Therefore, it is a good idea to change the depth unit first and then change ranges.

Range	
Range 1	: 30ft
Range 2	: 60ft
Range 3	: 120ft
Range 4	: 250ft
Range 5	: 500ft
Range 6	: 1000ft
Range 7	: 1600ft
Range 8	: 3000ft
Zoom Range	: 16ft
B/L Range	: 16ft
Split Range	: Off

Range 1 to Range 8

1. Use ▲ or ▼ to select a range and press the **ENTER** key. For example, select Range 1, and the setting window looks something like the one below.

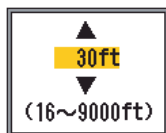

2. Use ▲ or ▼ to set range.
3. Press the **ENTER** key to set confirm setting.

Zoom Range

Zoom range sets the range for the marker zoom and bottom zoom displays. Press ▲ or ▼ to set zoom range as desired. For the horizontal split screen, the range is one-half the value set.

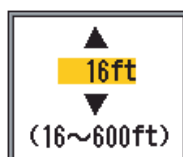

B/L Range

Set display range for bottom lock and bottom discrimination displays. Use ▲ or ▼ to set B/L range as desired. For the horizontal split screen, the range is one-half the value set.

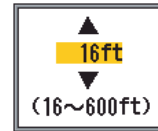

Split Range

Split range enables/disables independent adjustment of range in the dual frequency display. Turn on for independent adjustment. Effective in dual frequency mode only.

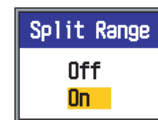

1. Rotate the **RANGE** control to show the range selection window. The window is displayed during six sec.

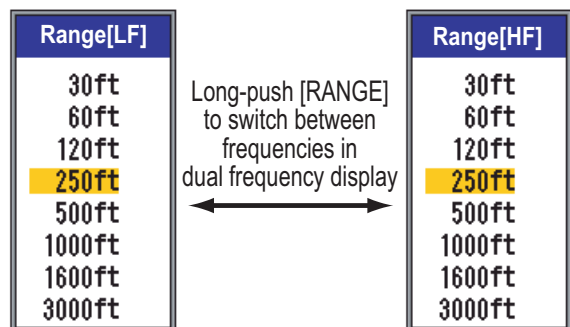

2. Push the **RANGE** control. Each press selects high or low frequency alternately.
3. Rotate the **RANGE** control to choose desired range.

2.4 Key Menu

The Key menu selects the function for the **FUNCTION** control and turns the key beep on or off.

Key	
FUNC Key	: TVG
Key Beep	: Off

2.5 Language Menu

The Language menu selects the language to use. Select Language and press the **ENTER** key. Use ▲ or ▼ to select language.



2.6 Units Menu

The Units menu lets you select the unit of measurement for depth, temperature, speed, wind, and distance, from the choices shown below.

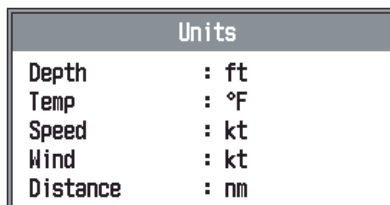

Depth: m, ft, fa, HR, pb

Temperature: °C, °F

Speed: kt, km/h, mph

Wind: kt, km/h, mph, m/s

Distance: nm, km, sm

2.7 Calib Menu

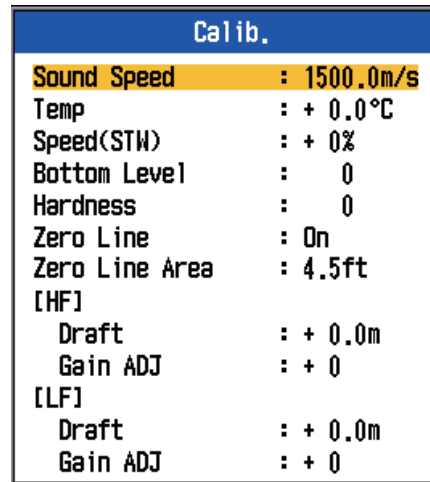

Sound Speed

Adjust the sound velocity of the Tx/Rx signal if the depth indication is incorrect, because of water temperature or salinity density.

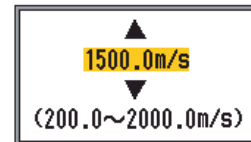

Temp

If the water temperature indication is wrong, you can apply an offset to it to correct it. Refer to the installation manual.

Speed (STW)

If the speed indication is wrong, you can apply an offset to it to correct it. Refer to the installation manual.

Hardness

If the hardness value output via NMEA is incorrect, apply an offset to correct it.

Bottom Level

In the default bottom level setting (0), the equipment judges consecutive strong echoes to be bottom echoes. If, in that setting, the depth indication is unstable, adjust the bottom level. If vertical lines extend upward from the bottom echo in the bottom lock display, lower the bottom level to erase the vertical lines. If the level is too low, however, it may be difficult to distinguish bottom fish from the bottom echo.

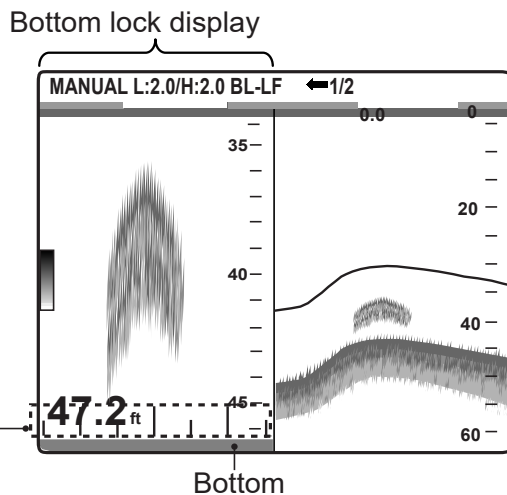

Set the bottom level so that these vertical lines just disappear.

Zero Line

Turn the zero line (transmission line) on or off. When turned off, the transmission line disappears, which allows you to better watch fish echoes near the surface. The length of the transmission line changes with transducer used and installation characteristics. If the width of the transmission line is 4.5 ft (default value) or more, set the transmission line width with Zero Line Area, as follows.

Zero Line Area

This feature adjusts the rejection width of the transmission line from the area specified when the menu item Zero Line is turned off. The effective range is 4.5 to 9.8 ft. For a long tail, increase the value. If the transmission line does not disappear, raise the STC or lower the Tx power.

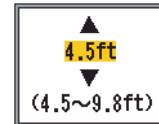

[HF]. [LF]

Draft: The default depth display shows the distance from the transducer. If you would rather show the distance from the sea surface, set your ship's draft.

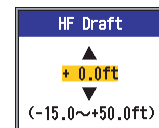

Gain ADJ: If the gain is too high or too low, or there is a difference in the gain between the low and high frequencies, you can compensate for it here.

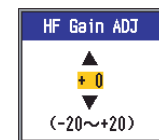

3. MAINTENANCE & TROUBLE-SHOOTING



WARNING



ELECTRICAL SHOCK HAZARD
Do not open the equipment.

Hazardous voltage exists inside the equipment. Only qualified personnel should work inside the equipment.

Use the proper fuse.

Use of a wrong fuse can result in damage to the equipment and cause fire.

IMPORTANT

Do not apply paint, anti-corrosive sealant or contact spray to coating or plastic parts.

Those items contain organic solvents that can damage coating and plastic parts, especially plastic connectors.

3.1 Maintenance

Regular maintenance is essential for good performance. Checking the items listed in the table below monthly will help keep your equipment in good shape for years to come.

Item	Action
Transducer cable	Check cable for damage.
Power cable, transducer cable plug	Check that they are tightly fastened. Refasten if necessary.
Display unit ground	Check for corrosion. Clean if necessary.
Power supply voltage	Check voltage. If out of rating, correct problem.

3.2 Care of Display Unit

For the chassis, dust or dirt on the cabinet can be removed with a soft, dry cloth. For stubborn dirt, water-diluted mild detergent can be used. In this case, wipe the cabinet with a dry cloth after using detergent. Do not use solvents such as thinner, acetone or benzene to clean the unit. They can remove paint and markings.

For the LCD screen, wipe the LCD carefully to prevent scratching, using tissue paper and an LCD cleaner. To remove dirt or salt deposits, use an LCD cleaner, wiping slowly with tissue paper so as to dissolve the dirt or salt. Change paper frequently so the salt or dirt will not scratch the LCD. Do not use solvents such as thinner, acetone or benzene for cleaning. Also, do not use degreaser or antifog solution, as they can strip the coating from the LCD.

3.3 Transducer Maintenance



Marine life on the transducer face will result in a gradual decrease in sensitivity. Check the transducer face for cleanliness each time the boat is dry-docked. Carefully remove any marine life with a piece of wood or fine-grade sandpaper.

3.4 Fuse Replacement

The two fuses (Type: FGMB-A 125V 6A PBF, Code No.: 000-157-492-10) inside the display unit protect the equipment from overcurrent. If the equipment can not be powered, contact your dealer for advice.

3.5 Battery Voltage Alert

When the battery voltage is too high or low, the audio and visual alarms are released. Check the battery when a battery icon appears at the upper right of the display.

Icon	Meaning
	Voltage is lower than 10 VDC. If the voltage goes below 9 V, the equipment automatically shuts itself off.
	Voltage is higher than 33 VDC. If the voltage goes higher than 34 V, the equipment automatically shuts itself off.

3.6 Troubleshooting

The table below provides basic troubleshooting procedures which the user may follow to restore normal operation.

Symptom	Remedy / Possible cause
Neither echo nor fixed range scale appears.	<ul style="list-style-type: none"> • Check battery voltage. • Check fuse. • Check power cable.
No echo appears but fixed range scale appears	<ul style="list-style-type: none"> • Check if display advance is set to "Stop". • Check transducer plug. • Check transducer cable.
Echo appears but no zero line.	<ul style="list-style-type: none"> • Check if range shifting is set to "0". • Check if zero line is on. • Check if the draft is more than zero.

Symptom	Remedy / Possible cause
Sensitivity is low.	<ul style="list-style-type: none"> • Check gain setting. • Air bubbles, marine life on transducer face. • Sediments in water. • Bottom is too soft to return an echo.
Extreme interference or noise	<ul style="list-style-type: none"> • Transducer is too close to engine. • Check if unit is properly grounded. • Check if other echo sounders of same frequency as own are being operated nearby.
Speed and/or water temperature readout is unrealistic or not shown.	<ul style="list-style-type: none"> • Check the sensor connection.
Position readout is unrealistic or not shown.	<ul style="list-style-type: none"> • Check connection between sounder and navigator. • Check navigator itself.

3.7 Self Test

The self test checks the equipment for proper operation and displays various information.

1. Press the **MENU/ESC** key to open the menu.
2. Press **▲** or **▼** to select Tests to show the Tests menu.
3. Press the **ENTER** key.
4. Press **▲** or **▼** to select Test and then press the **ENTER** key. The self test results appear together with the key test screen, as shown above.
5. To escape at any time, press the **MENU/ESC** key three times.

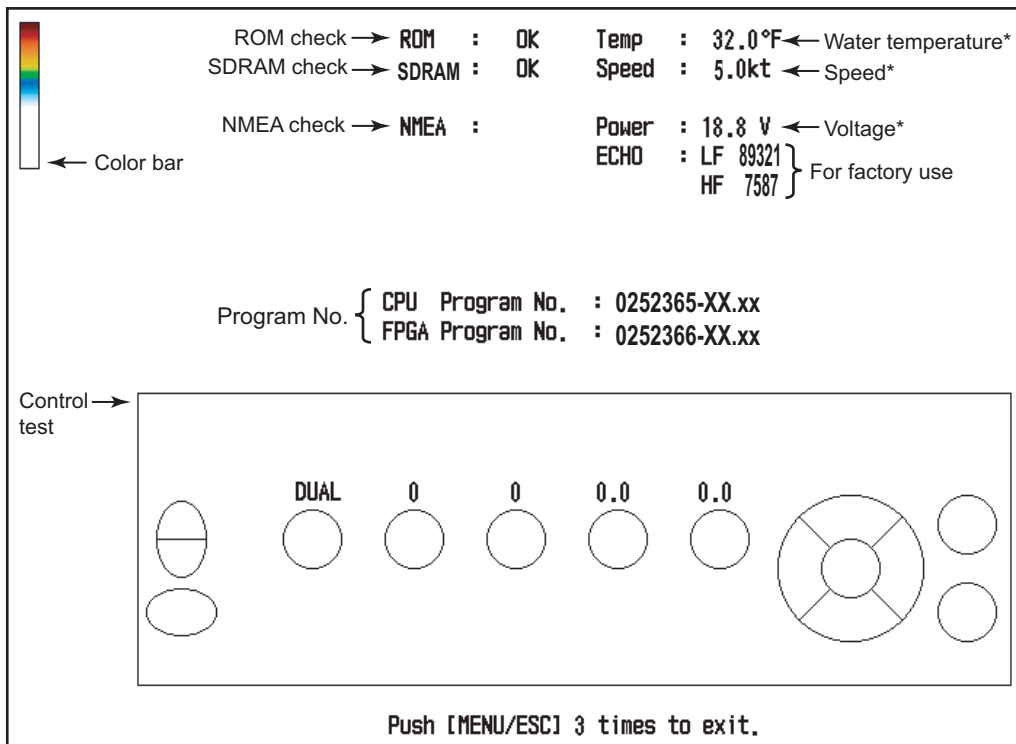
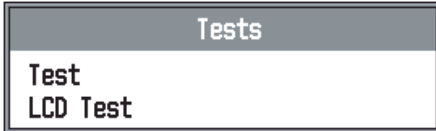

XX=Program no.
 xx=Program version no.
 * Updated every second.

Self test description

ROM, SDRAM and NMEA checks: Result is shown as OK or NG (No Good). For any NG, try the test again. If the result is still NG, contact your dealer for advice. NMEA check shows no result. This check is for factory use only.

Control test: Check controls for proper operation.

- **Keys:** Push each key. The key's on-screen location turns red or white alternately and a beep sounds with each push.

- **FUNCTION, GAIN and RANGE controls:** Rotate the control while observing its on-screen location. Clockwise rotation increases the value; counterclockwise rotation decreases it. Next, push the control. Its on-screen location turns red or white alternately and a beep sounds with each push.
- **MODE control:** Rotate the control. The name of mode selected appears above the control's on-screen location. The location turns red or white alternately and a beep sounds with each push.

3.8 LCD Test

The LCD test checks for proper display of all colors. To stop the test at any time, press the **MENU/ESC** key.

1. Press the **MENU/ESC** key to open the menu.
2. Press **▲** or **▼** to select Tests to show the Tests menu and press the **ENTER** key.
3. Press **▲** or **▼** to select LCD Test and press the **ENTER** key.
4. Press any key except the **MENU/ESC** key to start the test.
5. Press any key except the **MENU/ESC** key to change the screen, in the sequence shown below. After the crosshatch screen is displayed, the Tests menu reappears.
6. Press the **MENU/ESC** key twice to close the menu.

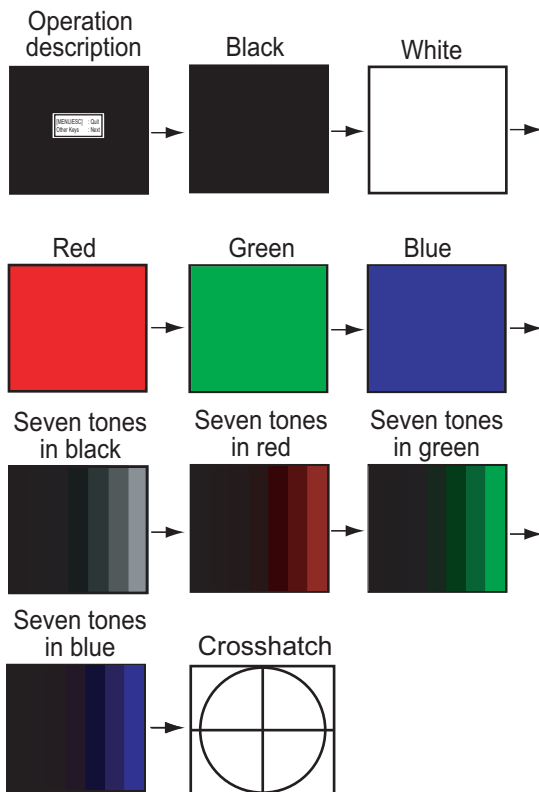

3.9 Restoring Default Settings

You may wish to restore default settings to start afresh.

1. Press the **MENU/ESC** key to open the menu.
2. Press **▲** or **▼** to select Reset at the bottom of the menu bar and press the **[ENTER]** key to show the Reset menu.



3. Press the **ENTER** key again. The confirmation window appears.



4. Press **▲** to select Yes and then press the **ENTER** key. A beep sounds, the equipment restarts, and then the installation menu appears.

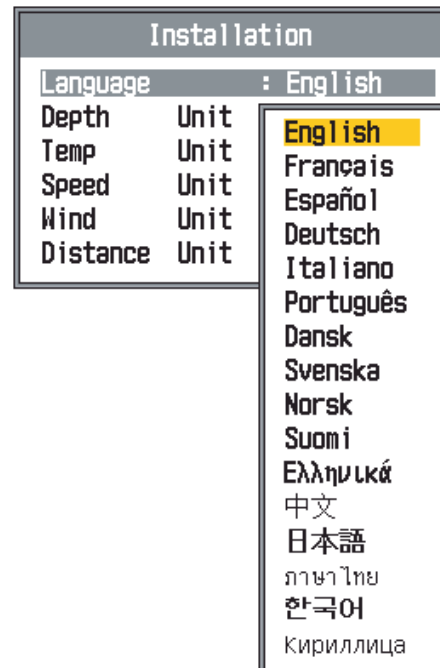

5. If necessary, select your language and units of measurement. Press the **MENU/ESC** key twice to finish.

APPX. 1 MENU TREE

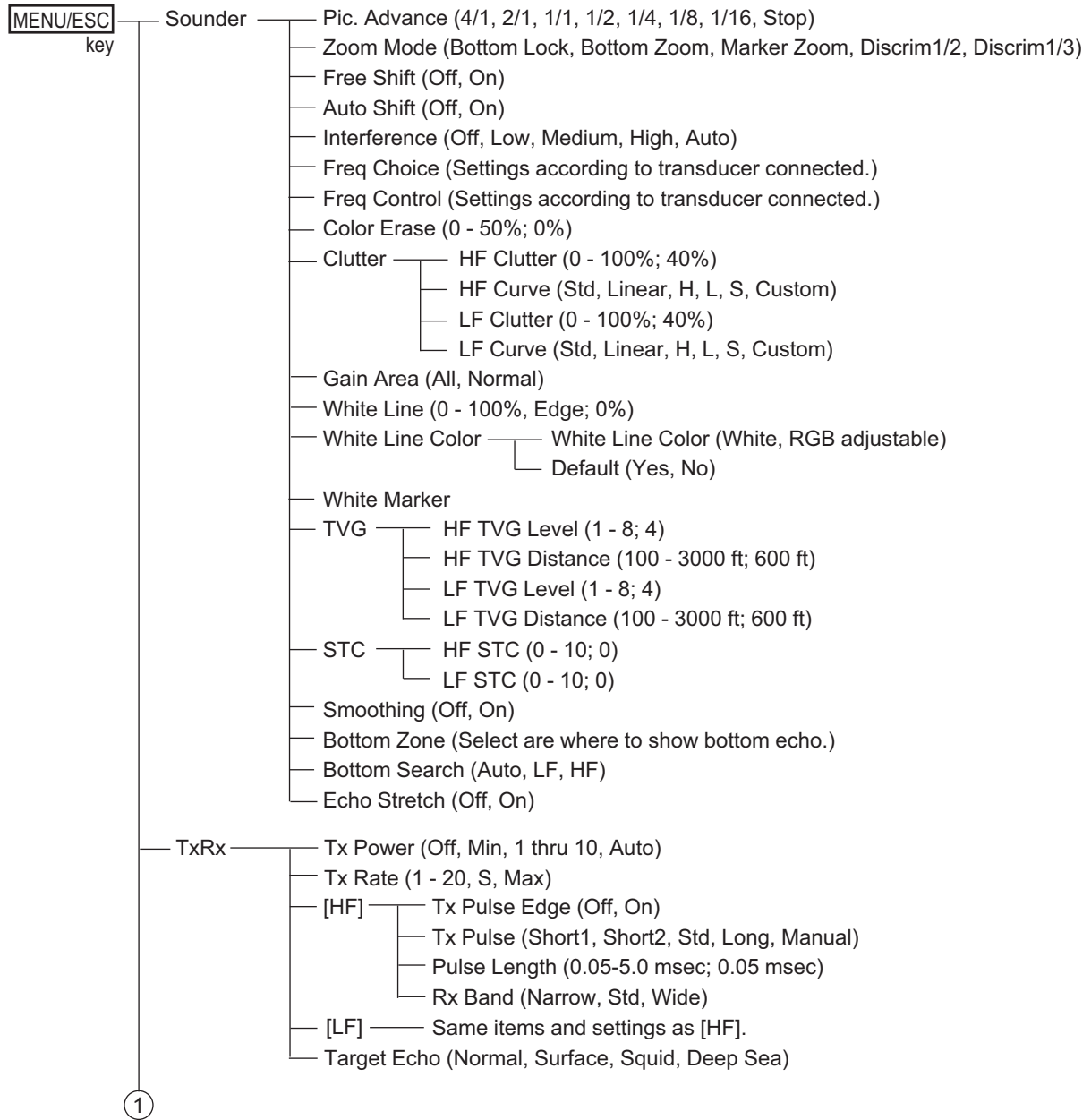

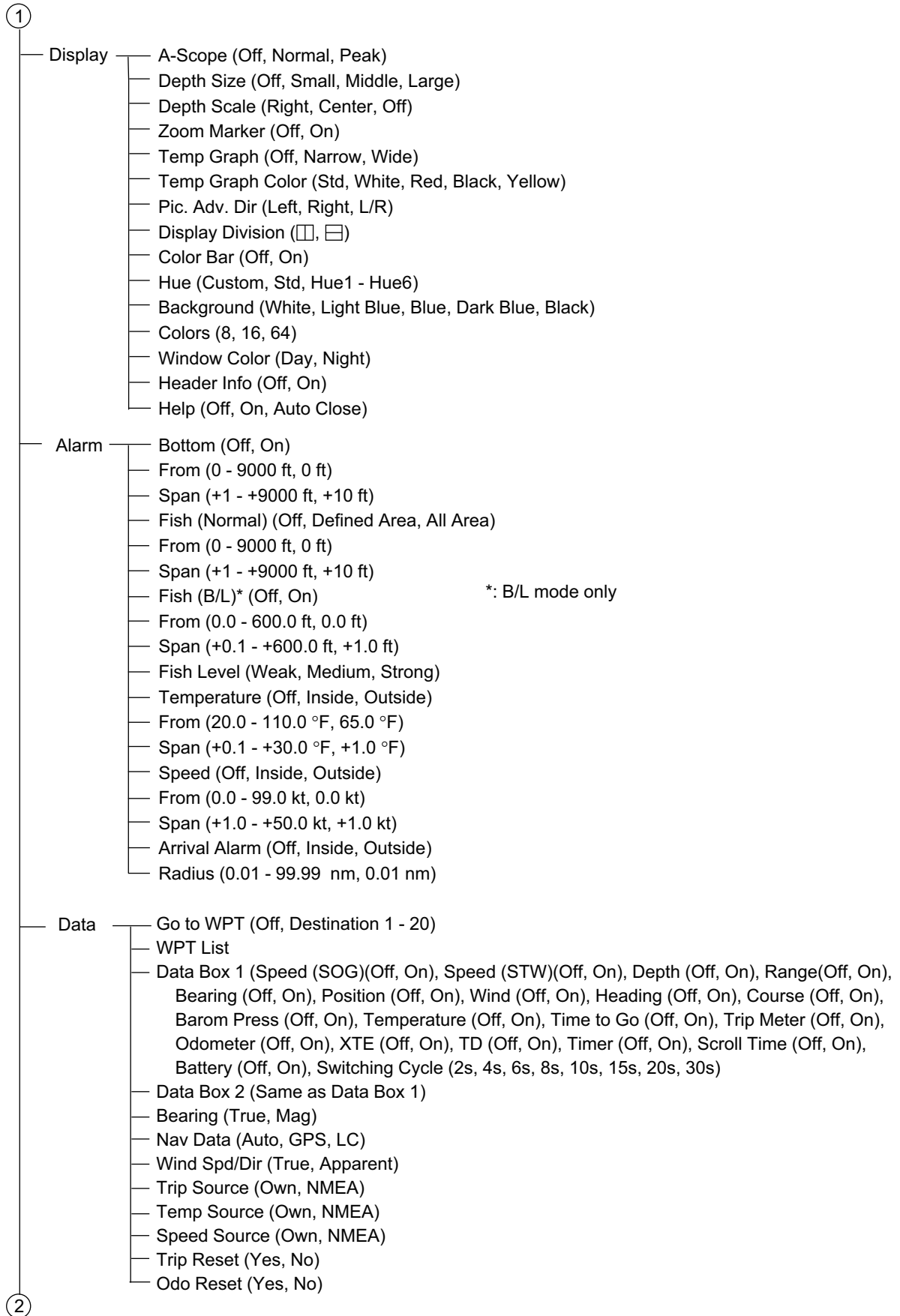

APPX. 1 MENU TREE

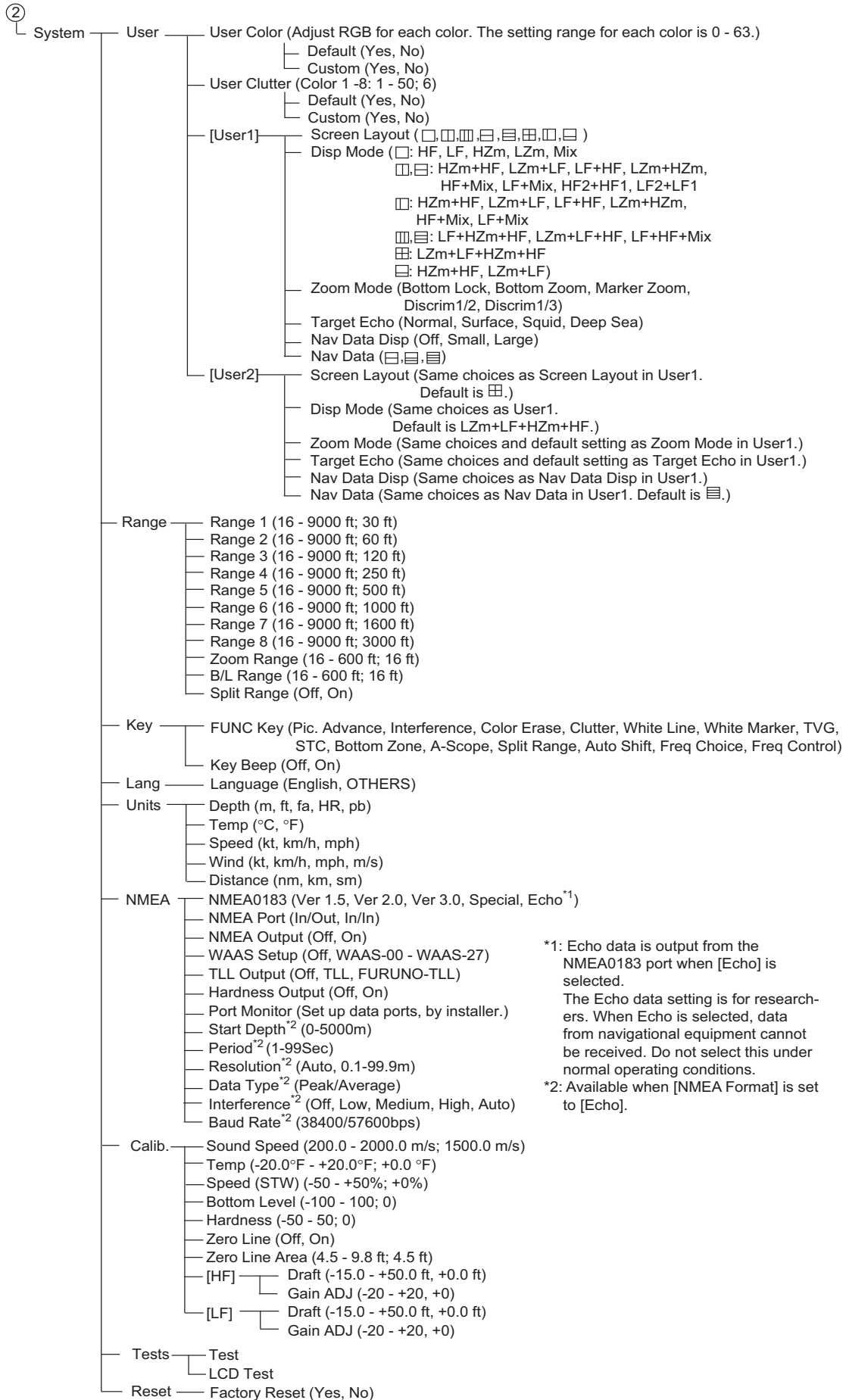

*1: Echo data is output from the NMEA0183 port when [Echo] is selected. The Echo data setting is for researchers. When Echo is selected, data from navigational equipment cannot be received. Do not select this under normal operating conditions.
 *2: Available when [NMEA Format] is set to [Echo].

APPX. 2 SCREEN LAYOUT

The screen may be divided as desired with Screen Layout on the User menu.

No split

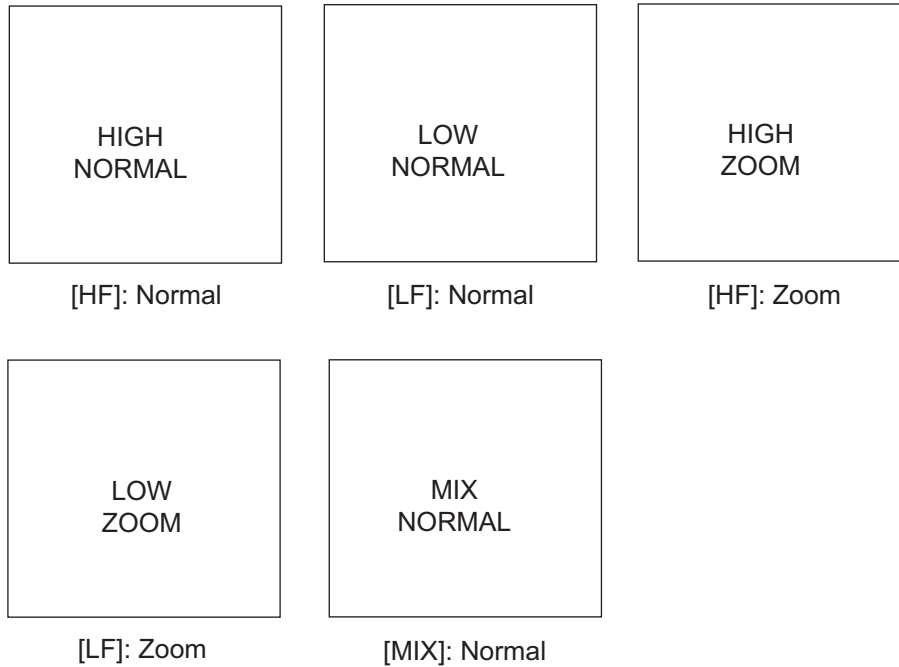

Two-way split

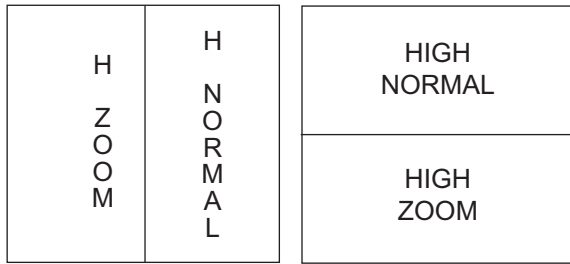

[HF]: Zm/Nor

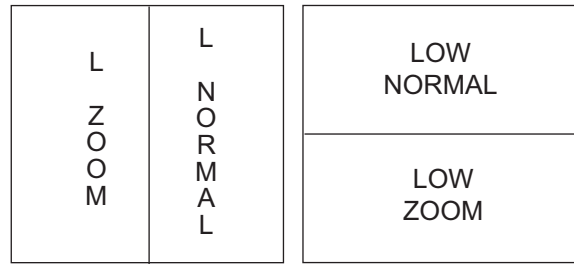

[LF]: Zm/Nor

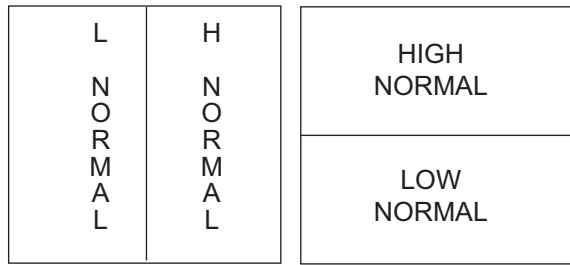

[LF]+[HF]

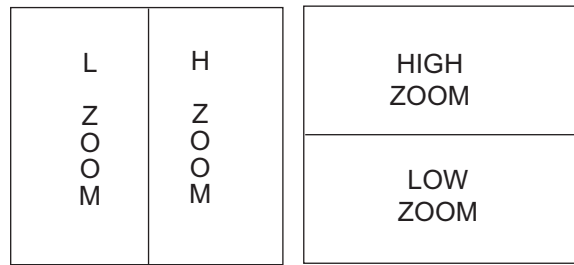

[LF]:Zm+[HF]:Zm

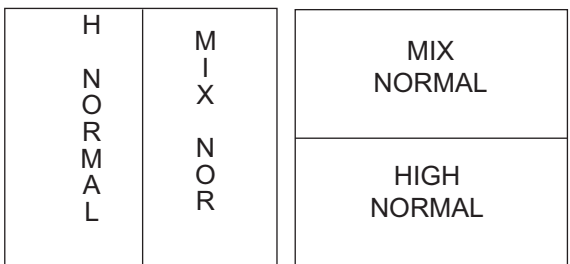

[HF]+[MIX]

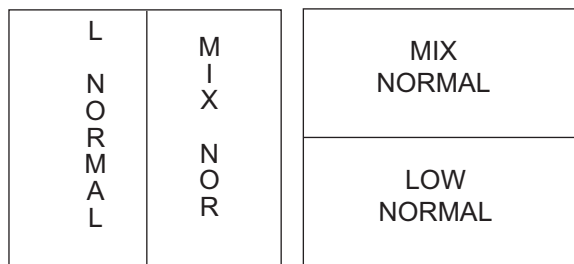

[LF]+[MIX]

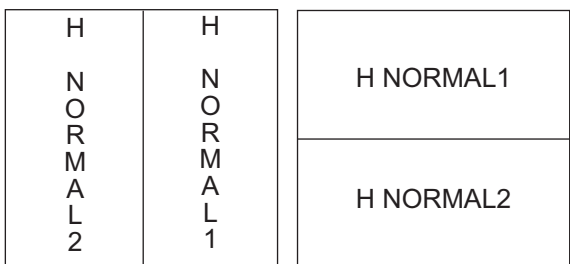

H2+H1

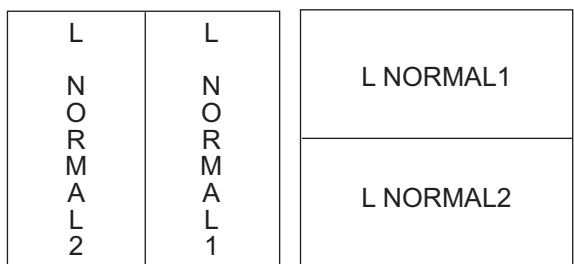

L2+L1

Note 1: For the vertical split (1:2), HZm+HF, LZm+LF, LF+HF, LZm+HZm, HF+Mix, LF+Mix only. The display division is 1/3 left and 2/3 right.

Note 2: For the horizontal split (1:2), HZm+HF, LZm+LF only. The display division is 1/3 downward and 2/3 upward.

Three-way split

L N O R M A L	H Z O O M	H N O R M A L	HIGH NORMAL
			HIGH ZOOM
			LOW NORMAL

[LF]+[HF]: Zm/Nor

L Z O O M	L N O R M A L	H N O R M A L	HIGH NORMAL
			LOW NORMAL
			LOW ZOOM

[LF]: Zm/Nor+[HF]

L N O R M A L	H N O R M A L	M I X N O R	MIX NORMAL
			HIGH NORMAL
			LOW NORMAL

[LF]+[HF]+[MIX]

Four-way split

LOW NOR	HIGH NOR
LOW ZOOM	HIGH ZOOM

[LF]: Zm/Nor+[HF]: Zm/Nor

APPX. 3 SCREEN DIVISION

The display may be divided vertically and horizontally as shown below, with Disp Division in the Display menu.

Horizontal division

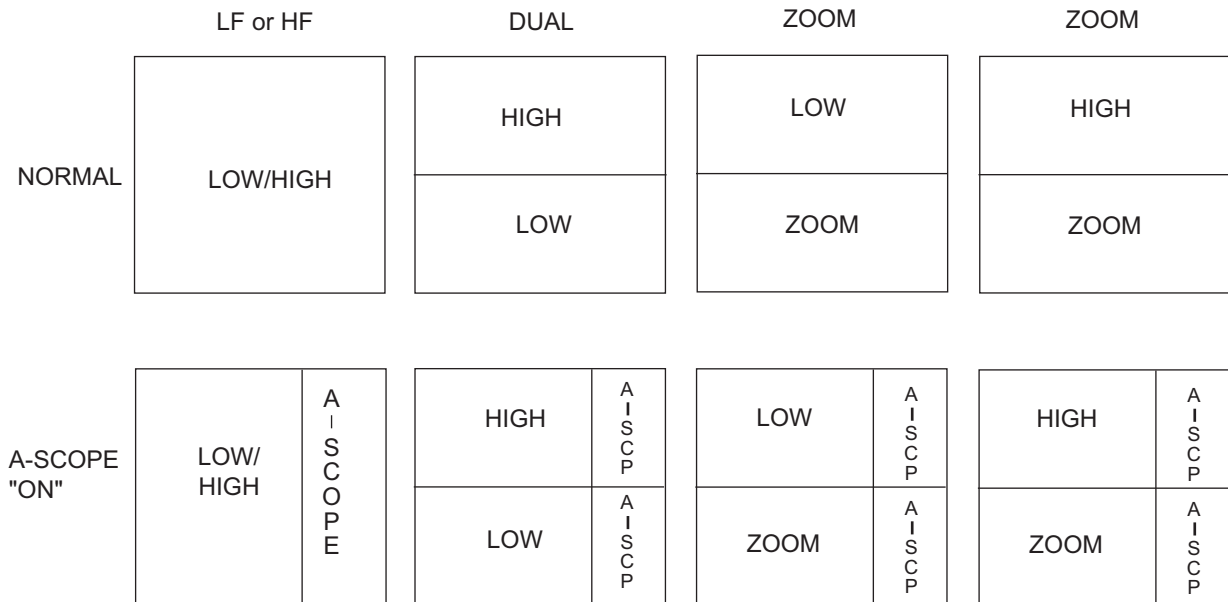

Vertical division

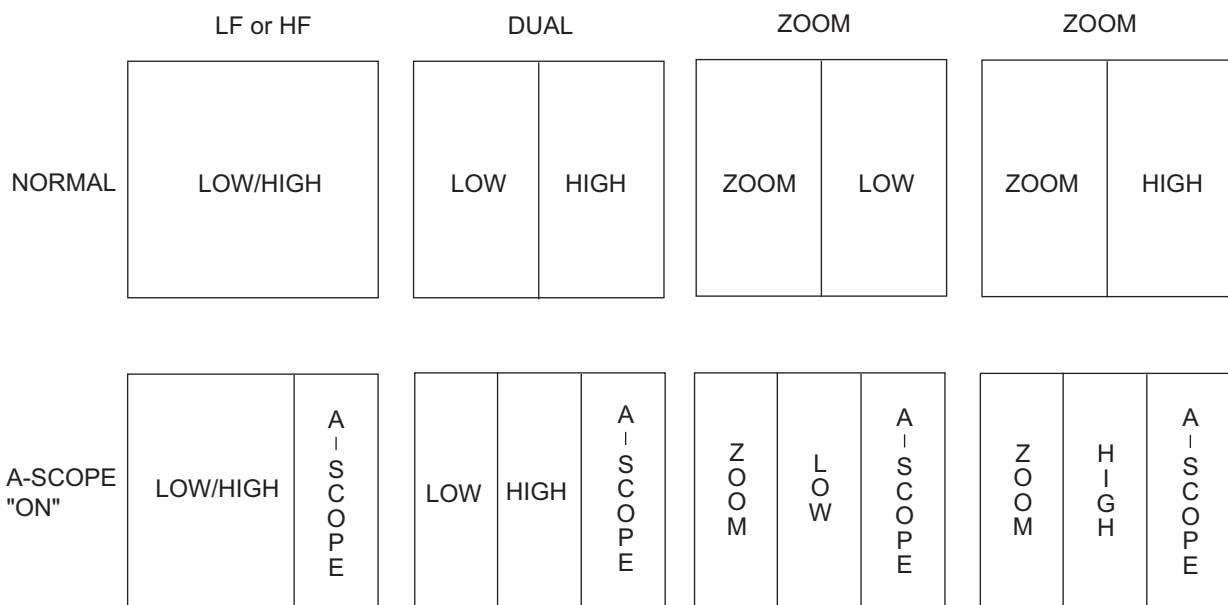

**SPECIFICATIONS OF COLOR LCD SOUNDER
FCV-295**

1 ECHO SOUNDER

- 1.1 TX frequency 28/38/50/68/82/88/107/150/200 kHz, select 2 channels
- 1.2 Output power 1, 2 or 3 kW
- 1.3 Power reduction Off/ Min/ 1 to 10/ Auto
- 1.4 TX rate Max. 3000 pulse/min
- 1.5 Pulselength 0.1 to 5.0 msec (manual: 0.05 to 5.0 msec)

2 DISPLAY UNIT

- 2.1 Display mode 10.4-inch color LCD, 640 x 480 dots
- 2.2 Brilliance 450 cd
- 2.3 Echo color 8/16/64 colors according to echo intensity
- 2.4 Background color Selectable among 5 colors.
- 2.5 Range shift Range: 5-3000 m, Shift: 0-2000 m, Expansion range: 5-200 m
- 2.6 Display mode Single-frequency, Dual-frequency, Zoom, User 1/2, A-scope
- 2.7 Zoom display Bottom-lock expansion, Bottom zoom, Marker zoom, Bottom discrimination
- 2.8 Picture advance speed 7 steps (Lines/TX: Stop, 1/16, 1/8, 1/4, 1/2, 1/1, 2/1, 4/1), Synchronize w/ ship's speed
- 2.9 Alarm Fish (Normal/Bottom), Water temperature, Bottom, Ship's speed/arrival
- 2.10 Noise limiter Frequency adjustable as transducer
- 2.11 Automatic indication Automatic gain adjust (fishing/cruising), Automatic range/shift, Water temperature graph (optional sensor required)

3 INTERFACE

- 3.1 Number of port NMEA0183 Ver.1.5/2.0/3.0 (I/O)1
- 3.2 Input data BWC, GGA, GLC, GLL, GNS, GTD, HDG, HDT, MDA, MTW, MWV, RMA, RMB, RMC, VHW, VTG, XTE
- 3.3 Output data DBS, DBT, DPT, MTW*, RMB, TLL, VHW
PFEC SDbhr/es1/es2/esd/mrk, pidat
*: Optional sensor required

4 POWER SUPPLY

- 4.1 Display unit 12-24 VDC: 2.6-1.3 A
- 4.2 Rectifier (PR-62, option) 100/110/220/230 VAC, 1 phase, 50/60Hz

5 ENVIRONMENTAL CONDITIONS

- 5.1 Ambient temperature -15°C to +55°C
- 5.2 Relative humidity 93% at +40°C
- 5.3 Degree of protection Panel: IP55, Chassis: IP22
- 5.4 Vibration IEC 60945

6 COATING COLOR

- 6.1 Display unit N2.5

INDEX

A

Alarms	
activating	13
arrival	13
bottom	13
fish (bottom lock)	13
fish (normal)	13
speed	13
water temperature	13
Arrival alarm	13
A-scope display	12
Auto shift	18

B

Background color	23
Battery voltage	33
Bearing format	24
Bottom alarm	13
Bottom discrimination display	4
Bottom level	31
Bottom lock display	3
Bottom lock range	29
Bottom search	21
Bottom zone	21
Bottom zoom display	4
Brilliance	2

C

Calib menu	30
Clutter	10
Color bar on/off	23
Color erase	10
Color quantity	23
Control description	1

D

Data box 1 and 2	24
Data menu	23
Default settings	35
Depth indication size	23
Depth measurement	8
Depth scale	23
Display division	23
Display selection	2
Draft	31
Dual frequency display	3

E

Echo stretch	21
--------------------	----

F

Fish (bottom) alarm	13
Fish (normal) alarm	13
Free shift	18
Frequency control	19
Frequency preset	19

FUNCTION control	15
Fuse replacement	33

G

Gain	
adjustment	7
Gain adjustment	31
GAIN control	7

H

Header info	23
-------------------	----

I

Interference rejector	9
-----------------------------	---

K

Key menu	29
----------------	----

L

Language menu	30
LCD test	35

M

Maintenance	32
Marker zoom display	4
Menu tree	AP-1
Mix display	27
MODE control	2

N

Nav data displays	28
Nav data source	24

O

Odometer reset	24
----------------------	----

P

Picture advance direction	23
Picture advance speed	9
POWER/BRILL key	2

R

RANGE key	5
Range menu	29
Range preset	29
Range selection	5
Rx bandwidth	22

S

Screen layout	26
Self test	34
SHIFT key	6
Smoothing	21
Sound speed offset	30
Sounder menu	18
Speed alarm	13
Speed offset	30
Speed source	24
Split range	29
System configuration	vi

System menu	25
T	
Target echo	22, 27
Trip distance reset.....	24
Trip distance source	24
Troubleshooting	33
TVG.....	11
Tx power	22
Tx pulse.....	22
Tx rate	22
U	
Unit menu.....	30
User 1 and 2 displays.....	26
description	5
User clutter.....	26
User color	25
User menu.....	25
V	
VRM	8
W	
Water temperature alarm	13
Water temperature graph	23
Water temperature graph color	23
Water temperature offset	30
Water temperature source	24
Waypoints	
destination waypoint.....	18
editing.....	17
entering	16
erasing	17
White line	20
White marker	20
Wind speed indication	24
Window color.....	23
Z	
Zero line	31
Zoom marker.....	23
Zoom mode preset.....	18, 27
Zoom range.....	29



Declaration of Conformity



We **FURUNO ELECTRIC CO., LTD.**

(Manufacturer)

9-52 Ashihara-Cho, Nishinomiya City, 662-8580, Hyogo, Japan

(Address)

declare under our sole responsibility that the product

COLOR LCD SOUNDER FCV-295

(Model name, type number)

to which this declaration relates conforms to the following standard(s) or other normative document(s)

EU
EMC Directive 2014/30/EU

IEC 60945 Ed.4.0: 2002

For assessment, see
• Test report
Furuno Labotech International Co., Ltd.
FLI 12-08-017, 3 Apr 2008

UK
SI 2016 No.1091 EMC Regulations 2016 as amended

EN 60945: 2002

For assessment, see
• Test report
Furuno Labotech International Co., Ltd.
FLI 12-08-017, 3 Apr 2008

(title and/or number and date of issue of the standard(s) or other normative document(s))

On behalf of Furuno Electric Co., Ltd.

Nishinomiya City, Japan
26 July 2021

(Place and date of issue)

Akihiko Kanechika
Department General Manager
Quality Assurance Department

(name and signature or equivalent marking of authorized person)